



(86) Date de dépôt PCT/PCT Filing Date: 1993/11/05
 (87) Date publication PCT/PCT Publication Date: 1994/05/26
 (45) Date de délivrance/Issue Date: 2004/10/12
 (85) Entrée phase nationale/National Entry: 1994/07/06
 (86) N° demande PCT/PCT Application No.: JP 1993/001598
 (87) N° publication PCT/PCT Publication No.: 1994/011092
 (30) Priorité/Priority: 1992/11/10 (4-324800) JP

(51) Cl.Int.⁷/Int.Cl.⁷ A61L 2/232, A61L 9/20, B01J 19/08,
B01J 21/06, C04B 41/85

(72) Inventeurs/Inventors:
WATANABE, TOSHIYA, JP;
KITAMURA, ATUSHI, JP;
KOJIMA, EIICHI, JP;
HASHIMOTO, KAZUHITO, JP;
FUJISHIMA, AKIRA, JP

(73) Propriétaire/Owner:
TOTO LTD., JP

(74) Agent: SIM & MCBURNEY

(54) Titre : METHODE DE TRAITEMENT PHOTOCATALYTIQUE DE L'AIR EN ECLAIRAGE AMBIANT
 (54) Title: PHOTOCATALYTIC AIR TREATMENT PROCESS UNDER ROOM LIGHT

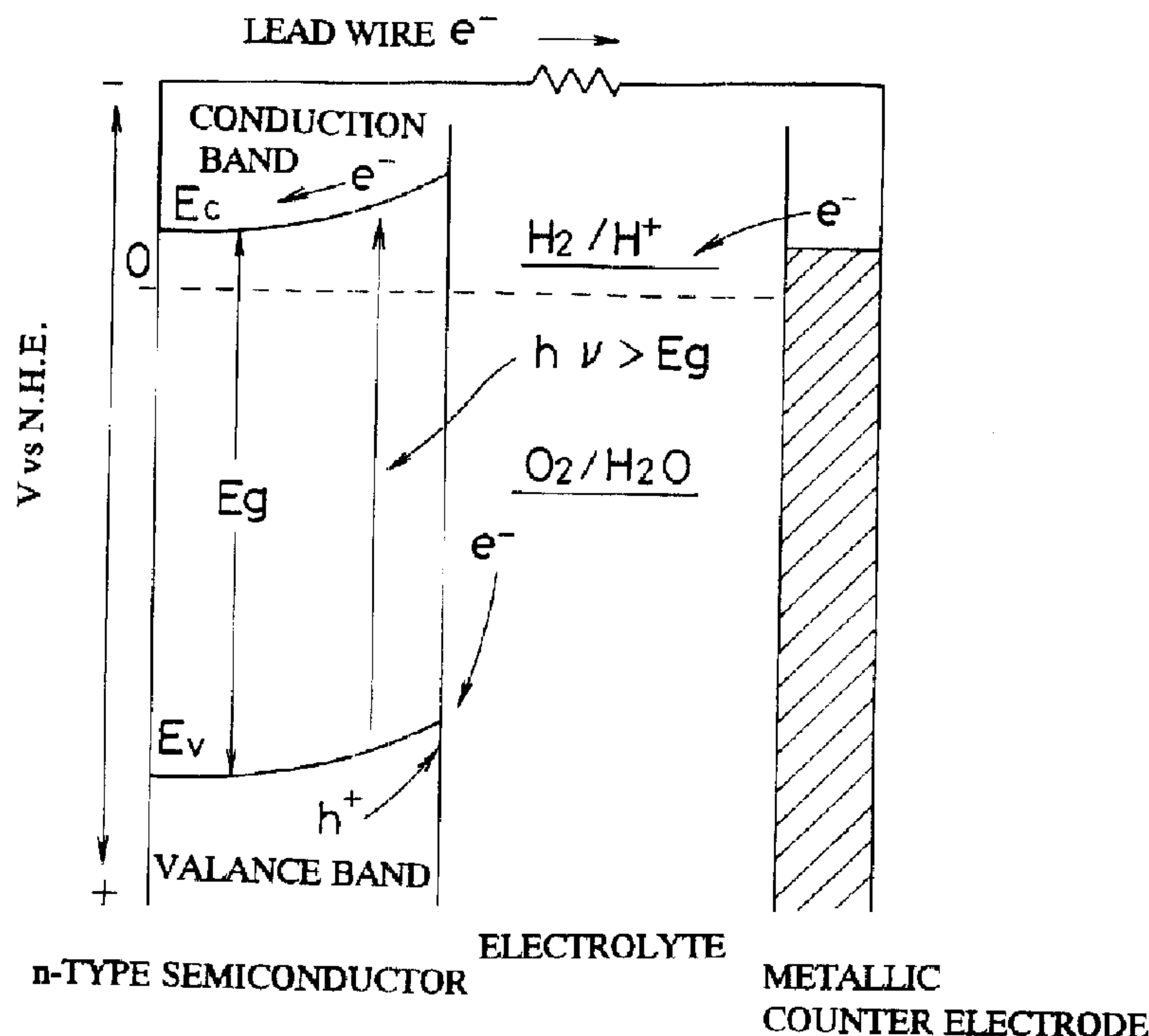

(57) Abrégé/Abstract:

A process for photocatalytically treating a hospital room contaminated by bacteria or an interior environment bearing airborne malodorous substances. A thin film of photocatalyst made of semiconductor such as titanium dioxide is disposed on the inner wall of the hospital room or living space. The photocatalytic thin film is irradiated by a light source of general lighting applications, such as a fluorescent lamp, and is photoexcited by a small amount of ultraviolet radiations included in the light of fluorescent lamp. The wattage of the fluorescent lamp as well as the distance between the photocatalytic thin film and the lamp are selected such that the intensity of those UV radiations which have a higher energy than the band gap energy of the photo-catalyst is 0.001-1 mW/cm², preferably, 0.01-0.1 mW/cm². The bacteria and chemical compounds deposited on the photoexcited thin film are photodecomposed.



2127552

ABSTRACT

A process for photocatalytically treating a hospital room contaminated by bacteria or an interior environment bearing
5 airborne malodorous substances. A thin film of photocatalyst made of semiconductor such as titanium dioxide is disposed on the inner wall of the hospital room or living space. The photocatalytic thin film is irradiated by a light source of general lighting applications, such as a fluorescent lamp, and is
10 photoexcited by a small amount of ultraviolet radiations included in the light of fluorescent lamp. The wattage of the fluorescent lamp as well as the distance between the photocatalytic thin film and the lamp are selected such that the intensity of those UV radiations which have a higher energy than the band gap energy of
15 the photo-catalyst is $0.001-1 \text{ mW/cm}^2$, preferably, $0.01-0.1 \text{ mW/cm}^2$. The bacteria and chemical compounds deposited on the photoexcited thin film are photodecomposed.

DESCRIPTION

PHOTOCATALYTIC AIR TREATMENT PROCESS UNDER ROOM LIGHT5 Technical Field

The present invention relates to a photocatalytic process for the treatment of an indoor environment contaminated by bacteria and airborne substances.

Background Art

10 Living spaces of residences and offices may carry airborne malodorous substances including sulfur compounds such as hydrogen sulfide and methyl mercaptan, nitrogen compounds such as ammonia, and other compounds such as fatty acid. To provide a comfort of living environment, it is desirable to treat the contaminated air
15 for removal of the malodorous substances. In medical environment, on the other place, antibiotic medication has induced inadvertent evolution of those bacteria having resistance against antibiotics. Among them, methicillin-resistant *Staphylococcus aureus* (MRSA), for example, has caused serious
20 problem of nosocomial (i.e., in-hospital) infection.

Accordingly, attention has been drawn toward the use of semiconductive photocatalyst for the purposes of processing the environment contaminated by bacteria and malodorous substances.

25 Since one of the inventors of the present invention and his coworker have reported their investigation on photoelectrolytic process of water (known as the "Honda and Fujishima effect") in a photoelectrochemical cell having a single-crystal semiconductor electrode of titanium dioxide (TiO_2) in the form of rutile and a counter electrode of platinum (Nature, vol. 238(1972), 37-38),
30 many researches have been carried out on the treatment of various media with semiconductive photocatalyst.

To briefly set out the principle of the photocatalytic process in a photoelectrochemical cell with reference to FIG. 1 of the accompanying drawings, when a semiconductor photocatalyst
35 is illuminated and is caused to absorb the light energy ($h\nu$)

higher than the band gap energy (E_g) of the semiconductor, the electrons in the valance band is photoexcited onto the conduction band to produce electron-hole pairs (e^-h^+) at the surface layer of the semiconductor.



In order for the thus generated electrons and holes to contribute in the photoelectrolysis of water, they must be moved, respectively, to separate oxidation and reduction sites that are spaced from each other (charge separation). Otherwise, the
10 electrons and holes would encounter recombination to result conversion into thermal energy without contributing in the redox process.

In a photoelectrochemical cell wherein a semiconductor-electrolyte junction is present, charge separation is carried out
15 in the following manner. Thus, as the semiconductor is brought into contact with the electrolyte, transfer of charges occurs until the Fermi levels in both phases become equal. As a result, in the n-type semiconductor such as TiO_2 , the semiconductor surface is positively charged. The electric field developed by
20 the charges causes a bending of the bands in the space charge region near the semiconductor surface as shown in FIG. 1. The electrons in the conduction band and the holes in the valance band are separated by the band bending, with the electrons e^- moving to the bulk and the holes h^+ moving to the surface of the
25 semiconductor. The holes h^+ moved to the semiconductor surface oxidize water to generate hydrogen



whereas the electrons e^- transferred via the lead wire to the metallic counter electrode reduce water to produce hydrogen



Since the success of the photoelectrolytic process of water in the photoelectrochemical cell has been published, A. J. Bard reported that, not only the photoelectrochemical cell having a single-crystal semiconductor electrode, platinized TiO_2 powders
35 also function as the photoelectrochemical cell (Journal of

Photochemistry, 10(1979), 59-75). A. J. Bard considers that a platinized TiO₂ particle functions as a short-circuited photoelectrochemical cell.

Thereafter, it has been found that even bare TiO₂ particles present photocatalytic effect and various investigations and researches have been made on the photocatalytic decomposition of ammonia, carboxylic acid, phenol and other compounds (e.g., H. Kawaguchi, Environmental Technology Letters, vol. 5, pp 471-474).

In this regard, it is believed that, in photocatalytic decomposition of compounds, holes h⁺ and electrons e⁻ generated by photoexcitation of semiconductor photocatalyst serve to oxidize and reduce surface hydroxyl group and surface oxygen, respectively, to generate OH radical (·OH) and superoxide ion (O₂⁻)

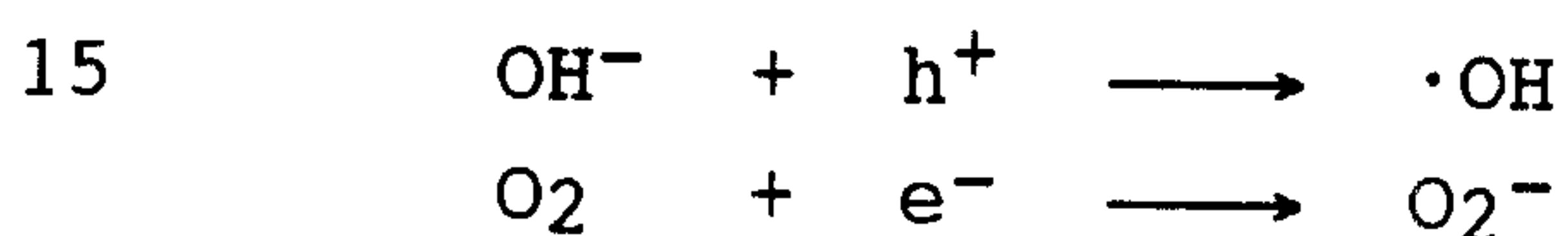

These species are highly active and induce redox process of the compounds. It is considered that photodecomposition of a compound is a multiple electron process. Thus, the original species is transformed through a plurality of intermediates into final products.

Turning to the prior art, it has been considered that, to photoexcite a photocatalyst to provoke a photocatalytic process, it is desirable to use ultraviolet radiations of a high light energy and to irradiate them at as high light intensity as possible. For example, Japanese Patent Kokai Publication No. 2-280818 proposes a process of deodorizing air wherein UV radiations having a wave length of 250 nm are irradiated at an intensity greater than 2 mW/cm² to excite a photocatalyst. Similarly, Japanese Patent Kokai Publication No. 63-267867 discloses a deodorizer device wherein UV radiations having a wave length of 250 nm issued from a germicidal lamp are irradiated on the photocatalyst. It will be noted, however, that UV radiations having such a short wave length of 250 nm are harmful to human bodies so that, under UV irradiation, it is necessary to wear

protective glasses. Therefore, the prior art process is not directly applicable to a living environment so that the living spaces must be shielded against the UV light source.

Furthermore, to strengthen the UV intensity, the light source
5 must be located sufficiently close to the photocatalyst. This limits the surface area of irradiation. Another disadvantage is that expensive germicidal lamps made of quartz glass tube permeable to UV light of 250 nm wave length are required.

In Japanese Patent Kokai Publication No. 4-307066, there is
10 disclosed a deodorizer system wherein UV radiations having a wave length of less than 410 nm are illuminated on a panel coated with photocatalyst. This system is designed such that the light source is shielded from the indoor space because the intensity of UV light is so high. Consequently, the system cannot be applied
15 to sterilization of an exposed surface, such as the interior wall of care room of a hospital, which may be accessed by people. Moreover, a special purpose light source for photoexciting the photocatalyst must additionally be provided.

20 Disclosure of the Invention

The object of the present invention is to provide a photocatalytic process for treating an indoor environment contaminated by bacteria and airborne particulate or volatile substances which may be carried out without resort to a light source which is
25 harmful to human being.

Another object of the invention is to provide a photocatalytic treatment process which is suitable to effectively sterilize the interior walls of a living space such as a hospital room.

30 A still another object of the invention is to provide a photocatalytic treatment process which does not necessitate the use of a special light source for excitation of a photocatalyst.

A further object of the invention is to provide a photocatalytic treatment process which is adapted to induce the
35 required photocatalysis at a minimum electric power consumption.

Another object of the invention is to provide a photocatalytic treatment process which does not interfere or hinder daily use, appearance and ornamentation of a room.

According to the present invention, there is provided a process for photocatalytically treating an indoor environment or air which is contaminated by bacteria and particulate or volatile substances.

The first feature of the photocatalytic process according to the invention is that a photocatalyst which is in the form of a thin film of a solid-state semiconductive material is provided on at least a part of the interior wall of an indoor space to ensure that the interior wall by itself is utilized to provide a reaction surface of photocatalysis. When bacteria and/or airborne substances are brought in contact with the photoexcited thin-film photocatalyst, they are photodecomposed in situ.

As in this manner the inner wall of the indoor space is lined with the thin film of photocatalyst to cause the inner wall per se to provide the reaction surface, the thin film of photocatalyst can be exposed directly to the room. This is particularly advantageous when the process according to the invention is carried out for the purposes of sterilization. Because any bacteria would be killed in situ by the action of photocatalyst upon deposition onto the wall surface lined with the photocatalytic thin film, bacterial infection via wall surface contagion can be effectively prevented.

The room lined with the thin film of photocatalyst may also be regarded as a large photocatalytic reactor. Therefore, photocatalytic reaction surface having as large surface area as required for photocatalytic decomposition can be readily secured so as to induce an adequate amount of photocatalysis. In addition, in contrast to the conventional suspended particulate system wherein a reaction vessel equipped with a fluid transfer device and agitation device is required, the thin film system according to the invention does not necessitate installation of such a separate reaction vessel. Instead, the thin film of

photocatalyst may be readily provided on the inner walls of the indoor spaces.

The second feature of the treatment process according to the invention resides in that the photocatalyst is excited by making use of an electric lamp for general lighting applications (hereinafter general-application lamp), such as a fluorescent lamp, which is provided in a room. To this end, the thin film of photocatalyst is disposed within the range of irradiation of the general-application electric lamp. The commercial general-application electric lamps are safe and harmless since they are primarily designed to cut off harmful UV radiations having a wavelength of less than 300 nm. For example, low-pressure mercury lamps intended for general lighting applications, such as fluorescent lamps, are adapted to convert harmful UV rays, which are emanating from mercury atoms excited by electric discharge and which have an intrinsic wave length of about 254 nm, into visible light rays by way of photoluminescence of fluorescent substance. However, the light radiating from the general-application electric lamp such as fluorescent lamp includes at least a small amount of UV radiations of a wave length range having the light energy higher than the band gap energy of the semiconductor photocatalyst. Therefore, the general-application electric lamp may be used for the purposes of photoexcitation of the photocatalyst, in addition to its intended original purpose of interior illumination.

Since in this manner the photocatalyst is photoexcited by a light source implemented by a general-application electric lamp, there is no need for a separate UV light source for excitation of the photocatalyst. Advantageously, the light source is utilized in two ways for room illumination as well as for photoexcitation of the photocatalyst. In addition, as the light of a general-application electric lamp is exempt from harmful UV radiations, the living region need not be shielded against the light source as in the prior art. Accordingly, the thin film of photocatalyst may be exposed to a room for the purposes of sterilization as

described hereinbefore to ensure that the photocatalytic thin film be disposed on a wall surface at whichever locations people are apt to access.

5 The third feature of the invention is related to the quantum yield of the light energy absorbed by the semiconductor photocatalyst, i.e., the ratio between the number of photons absorbed by the photocatalyst and the number of molecules undergone photoelectrochemical reaction. According to the invention, the wattage of the general-application electric lamp
10 and the distance between the photocatalytic thin film and the lamp are so selected that the total incident light intensity of UV radiations having an energy higher than the band gap energy of the semiconductor photocatalyst is 0.001-1 mW/cm², preferably, 0.01-0.1 mW/cm².

15 This feature is based upon a finding that, in a photocatalytic system wherein a photocatalyst in the form of a thin film is employed and wherein, therefore, a solid-to-gas contact is present, the quantum yield of the light energy increases with decreasing UV intensity. More specifically, according to the
20 experiments conducted by the present inventors, it has been found that, in a thin film photocatalytic system, the quantum efficiency of the light energy absorbed by the photocatalyst increases in response to the decrease in the UV light intensity, as described later in more detail with reference to the
25 accompanying drawings. Although the reasons thereof is not clear, this may probably be explained as follows. Thus, photocatalytic decomposition of a compound is a multiple electron process and, therefore, the speed of decomposition is controlled by the rate-determining step. Contrary to the particulate or
30 powder system wherein a large surface area is available, the thin film system has a limited surface area so that the probability of the photo-generated electrons and holes to reach the reaction sites on the surface of the thin film within the life time thereof is quite small. Accordingly, in a thin film system, the
35 photodecomposition process is highly susceptible to the restraint

by the rate-determining step. When the rate-controlling step in the photoelectrochemical reaction reaches a steady state condition, any excessive electrons and holes once produced by photoexcitation of the photocatalyst would undergo recombination before inducing redox process at the reaction sites on the semiconductor surface and would be changed into heat. It is considered that, for these reasons, smaller the UV light intensity (photon density), the quantum yield of respective photons becomes greater.

Since in the process according to the invention a photocatalyst in the form of a thin film is employed and because such a thin film photocatalyst presents an increasing quantum efficiency with decreasing UV intensity, general-application electric lamps, such as fluorescent lamps, of limited UV intensity may advantageously be used to photoexcite the photocatalyst.

In this regard, as mentioned hereinbefore, an illuminated room lined with the photocatalytic thin film may be regarded as a photocatalytic reaction vessel of the batch type wherein the inner walls thereof act as the photocatalytic reaction surface. To discuss the relationship among the size of the reaction vessel, the total surface area of the reaction and the light intensity on the assumption that the light source is of a given output, as the size of the vessel is increased so that the distance between the light source and the photocatalytic reaction surface is in turn increased, the total surface area available for the installation of the photocatalytic thin film will be increased in proportion to the increase in the distance. However, the light intensity per unit surface area of the thin film will be decreased presumably in inverse proportion to the square of the distance. To the contrary, when the size of the reaction vessel is reduced, the area of the reaction surface will be decreased while the light intensity on that surface increases generally in inverse proportion to the square of the distance. It will be noted that the number of photons which effectively

2127552

contribute in the photocatalytic process without suffering electron-hole recombination is proportional to the product of the quantum yield multiplied by the light intensity (photon density) multiplied by the surface area of the thin film. In the light of
5 the finding of the present inventors that the quantum yield of the light energy absorbed by the photocatalytic thin film increases with decreasing light intensity, the reaction yield of the reaction vessel as a whole will be enhanced by irradiating a weak UV light upon a broader surface area of the photocatalytic
10 thin film, rather than irradiating a strong UV light energy on a narrower area. However, since the light intensity decreases in inverse proportion to the square of the distance, the reaction yield of the vessel as a whole would be decreased if the distance between the light source and the photocatalyst is set too large.
15 Optimum yield of photocatalysis performed by a room as a whole that functions as a photocatalytic reaction vessel will be attained by setting the wattage of the light source and the distance between the photocatalytic thin film and the light source such that the UV light intensity is 0.001-1 mW/cm².

20 Should the output of the light source and the distance be otherwise determined in such a manner that the UV light intensity is greater than 1 mW/cm², then the chance of electron-hole recombination would be increased so that a high electric power consumption would not be worthwhile from the view point of
25 efficiency of photoexcitation of photocatalyst and that the intensity of visible light illumination and the amount of heat dissipation would be excessive. If the UV light intensity is less than 0.001 mW/cm², the decomposition yield of the room would be insufficient.

30 In this manner, in a thin film system, a high efficiency is attainable by the use of a light source of a rather small UV intensity. According to the invention, therefore, the photocatalyst is advantageously photoexcited by weak UV energy available from the general-application electric lamps such as

fluorescent lamps to effectively induce photocatalysis at a minimum electric power consumption.

Preferably, the thin film of photocatalyst is made from powders of titanium dioxide (TiO_2). TiO_2 is a chemically stable, harmless and non-toxic material which advantageously exhibits a suitable band characteristics for redox process of substances and presents a high photocatalytic activity. It is preferable to use anatase form of TiO_2 , while rutile form TiO_2 metalized with copper, silver, platinum or other metals may be used. Also, photocatalytic thin film may be made from other semiconductor material such as WO_3 , CdS , SrTiO_3 , or MoS_2 .

The photocatalytic thin film of TiO_2 may be supported on a ceramic substrate such as a tile. In this case, by applying a TiO_2 sol on a glazed tile followed by firing at a temperature above the softening point of the glaze, the powders of TiO_2 are sintered with each other and are firmly bonded to the glaze, whereby a rigid sintered thin film of TiO_2 having a high wear resistivity is obtained. The tiles with the TiO_2 thin film thus supported thereon may readily affixed on the interior walls of a room. Preferably, the thickness of the thin film is 0.3-10 μm . With a greater thickness, the strength of the thin film would be lowered due to shrinkage during sintering so that the thin film would be vulnerable to abrasion. With a thickness less than 0.3 μm , photocatalytic activity would be inadequate.

The thin film of photocatalyst may also be provided by fixing the TiO_2 powders on a substrate of ceramics, wood, metal, plastics or other material by way of inorganic binder such as water glass and alkoxide or organic binder such as fluorocarbon polymers.

The light source for photoexciting the photocatalytic thin film may be selected from various commercially available general-application electric lamps depending on the desired intensity of visible and UV lights. For example, white light fluorescent lamp, pink light fluorescent lamp and incandescent lamp are suitable when the photocatalytic thin film is to be irradiated at

a low UV intensity. With blue light fluorescent lamp, an increased UV light is obtainable. If the UV intensity is to be increased further, black light fluorescent lamp and
5 black light blue fluorescent lamp having a major wave length of 350-360 nm will be appropriate. In the event that the visible light is to be intensified, a high intensity discharge (HID) lamp such as a metal halide lamp can be used.

10 The photocatalytic process of the invention may be applied to sterilization and antibacterial treatment of medical facilities such as care rooms and operation rooms of hospitals, antibacterial treatment and deodorization of living spaces such as residences and offices, sterilization
15 and antibacterial treatment of food processing factories and catering facilities, and cleansing of toilet floor and kitchen.

According to one aspect of the invention, there is provided a photocatalytic process for the treatment of
20 contaminated air in an indoor space, the process comprising the steps of: disposing at least one electric lamp to illuminate the space; providing a thin film of photocatalyst of solid-state semiconductor material on at least a part of the interior surface of the space in a
25 light receiving relationship from the lamp; the lamp being an electric lamp for general lighting applications adapted to emit light substantially having the wave length not less than 300 nm, the lamp being capable of emitting at least a small amount of ultraviolet radiations within the wave
30 length range between 300 nm and the wave length corresponding to the band gap energy of the semiconductor material; the wattage of the electric lamp and the distance between the thin film and the lamp being selected such that, when the lamp is energized, the total incident light

intensity, impinging upon the thin film, of ultraviolet radiations within the wave length range is 0.001-1 mW/cm² and, energizing the lamp whereby the thin film of
5 photocatalyst is photoexcited.

According to another aspect of the invention, there is provided a photocatalytic sterilization process for a walled environment wherein airborne bacteria are present, the process comprising the steps of: lining at least a part
10 of the wall with a thin film of photocatalyst made of sintered powders of titanium dioxide; disposing at least one electric lamp for general lighting applications in a light emitting relationship against the thin film; and, energizing the lamp to photoexcite the thin film of
15 photocatalyst; the electric lamp being adapted to emit light substantially having the wave length not less than 300 nm and being capable of emitting at least a small amount of ultraviolet radiations within the wave length range of 300-390 nm; the wattage of the electric lamp and
20 the distance between the thin film and the lamp being selected such that the total incident light intensity, per unit surface area of the thin film, of ultraviolet radiations within the wave length range of 300-390 nm is 0.001-1 mW/cm².

25 According to further aspect of the invention, there is provided a photocatalytic process for sterilizing bacterium-contaminated air in a medical facility, the process comprising the steps of: covering at least a part of the interior surface of the facility with a thin film of
30 photocatalyst of sintered powders of titanium dioxide; disposing at least one electric lamp for general lighting applications in a light emitting relationship against the thin film; and, energizing the lamp to photoexcite the thin film of photocatalyst; the electric lamp being adapted

to emit light substantially having the wave length not less than 300 nm and being capable of emitting at least a small amount of ultraviolet radiations within the wave length
5 range of 300-390 nm; the wattage of the electric lamp and the distance between the thin film and the lamp being selected such that the total incident light intensity, per unit surface area of the thin film, of ultraviolet radiations within the wave length range of 300-390 nm is
10 0.001-1 mW/cm².

According to another aspect of the invention, there is provided a photocatalytic antibacterial treatment process for a walled living environment, the process comprising the steps of: lining at least a part of the wall with a thin
15 film of photocatalyst made of sintered powders of titanium dioxide; disposing at least one electric lamp for general lighting applications in a light emitting relationship against the thin film; and, energizing the lamp to photoexcite the thin film of photocatalyst; the electric
20 lamp being adapted to emit light substantially having the wave length not less than 300 nm and being capable of emitting at least a small amount of ultraviolet radiations within the wave length range of 300-390 nm; the wattage of the electric lamp and the distance between the thin film
25 and the lamp being selected such that the total incident light intensity, per unit surface area of the thin film, of ultraviolet radiations within the wave length range of 300-390 nm is 0.001-1 mW/cm².

According to a further aspect of the invention, there
30 is provided a photocatalytic antibacterial treatment process for a walled food processing environment, the process comprising the steps of: lining at least a part of the wall with a thin film of photocatalyst made of sintered powders of titanium dioxide; disposing at least one

electric lamp for general lighting applications in a light emitting relationship against the thin film; and, energizing the lamp to photoexcite the thin film of photocatalyst; the electric lamp being adapted to emit light substantially having the wave length not less than 300 nm and being capable of emitting at least a small amount of ultraviolet radiations within the wave length range of 300-390 nm; the wattage of the electric lamp and the distance between the thin film and the lamp being selected such that the total incident light intensity, per unit surface area of the thin film, of ultraviolet radiations within the wave length range of 300-390 nm is 0.001-1 mW/cm².

According to another aspect of the invention, there is provided a photocatalytic process for the deodorization of polluted air in a walled living environment, the process comprising the steps of: lining at least a part of the wall with a thin film of photocatalyst made of sintered powders of titanium dioxide; disposing at least one electric lamp for general lighting applications in a light emitting relationship against the thin film; and, energizing the lamp to photoexcite the thin film of photocatalyst; the electric lamp being adapted to emit light substantially having the wave length not less than 300 nm and being capable of emitting at least a small amount of ultraviolet radiations within the wave length range of 300-390 nm; the wattage of the electric lamp and the distance between the thin film and the lamp being selected such that the total incident light intensity, per unit surface area of the thin film, of ultraviolet radiations within the wave length range of 300-390 nm is 0.001-1 mW/cm².

According to a further aspect of the invention, there is provided a photocatalytic process for the decomposition

of airborne contaminants in a walled living environment,
the process comprising the steps of: lining at least a part
of the wall with a thin film of photocatalyst made of
5 sintered powders of TiO_2 ; disposing at least one electric
lamp for general lighting applications in a light emitting
relationship against the thin film; and, energizing the
lamp to photoexcite the thin film of photocatalyst; the
electric lamp being adapted to emit light substantially
10 having the wave length not less than 300 nm and being
capable of emitting at least a small amount of ultraviolet
radiations within the wave length range of 300-390 nm; the
wattage of the electric lamp and the distance between the
thin film and the lamp being selected such that the total
15 incident light intensity, per unit surface area of the thin
film, of ultraviolet radiations within the wave length
range of 300-390 nm is 0.001-1 mW/cm².

According to another aspect of the invention, there is
provided a photocatalytic process for the decomposition of
20 deposits tending to foul a wall of an indoor space, the
process comprising the steps of: lining at least a part of
the wall with a thin film of photocatalyst made of sintered
powders of titanium dioxide; disposing at least one
electric lamp for general lighting applications in a light
25 emitting relationship against the thin film; and,
energizing the lamp to photoexcite the thin film of
photocatalyst; the electric lamp being adapted to emit
light substantially having the wave length not less than
300 nm and being capable of emitting at least a small
30 amount of ultraviolet radiations within the wave length
range of 300-390 nm; the wattage of the electric lamp and
the distance between the thin film and the lamp being
selected such that the total incident light intensity, per
unit surface area of the thin film, of ultraviolet

radiations within the wave length range of 300–390 nm is 0.001–1 mW/cm².

5 According to a further aspect of the invention, there is provided a process for sterilizing a surface of a sanitary earthenware or decomposing a substance deposited on the surface, comprising the steps of: forming a thin film of photocatalyst of sintered powders of titanium dioxide on at least a part of the surface of the sanitary earthenware; and irradiating the earthenware by an electric lamp for general lighting applications in such a manner that the total light intensity of ultraviolet radiations within the wave length range of 300–390 nm is 0.001–1 mw/cm².

15 According to another aspect of the invention, there is provided a room having a photocatalytic function, the room comprising: enclosing surfaces including vertical walls, a floor and a ceiling defining an interior for the room; a thin film of a photocatalytic semiconductor material having a band gap energy and covering at least a part of the enclosing surfaces of the room; an electric lamp mounted on one of the enclosing surfaces in a position whereby the semiconductor material is in a light receiving relationship with the lamp, the lamp being an electric lamp for general lighting applications emitting a visible light for illumination and at least a small amount of ultraviolet radiation within the wavelength range between 300 nm and the wavelength corresponding to the band gap energy of the semiconductor material, the wattage of the electric lamp and the distance between the semiconductor material and the lamp being such that, when the lamp is energized, the total incident light intensity, impinging upon the semiconductor material, of the ultraviolet radiation within the wavelength range is 0.001

to 1 mW/cm².

According to a further aspect of the invention, there is provided a glazed ceramic bathroom fixture selected from the group consisting of urinals, wash basins and toilet bowls, the bathroom fixture having a surface at least partially covered with a thin film of a photocatalytic semiconductor material.

According to another aspect of the invention, there is provided a glazed ceramic tile having a surface at least partially covered with a thin film of a photocatalytic semiconductor material.

The foregoing principle and features of the invention as well as other features thereof will become apparent in more detail from the following description made with reference to the accompanying drawings.

Brief Description of the Drawings

FIG. 1 is a schematic representation illustrating the principle of the semiconductor photocatalyst;

FIGS. 2-5 represent various layouts of light source and photocatalyst;

FIG. 6 is a cross-sectional view in a microscopically enlarged scale of a portion of a tile provided with a photocatalytic thin film;

FIGS. 7A-7D are graphs showing spectrum distribution of various commercial fluorescent lamps;

FIG. 8 is a schematic cross-sectional view of an apparatus used in the experimental examples of the invention;

FIG. 9 is a graph showing the variation in the methyl mercaptan content subjected to photodecomposition;

FIG. 10 is a graph showing the speed of photodecomposition of methyl mercaptan under different UV intensities, with the abscissa shown in a logarithmic scale;

5 FIG. 11 is a graph showing the quantum yield of photon under different UV intensities, with the abscissa similarly shown in a logarithmic scale;

FIG. 12 is a graph similar to FIG. 11, with the UV intensity shown along the abscissa of FIG. 11 being shown here in terms of the photon density;

10 FIG. 13 is a graph showing the effective photon density under different UV intensities, with the abscissa similarly shown in a logarithmic scale;

FIG. 14 is a schematic view showing a model of a photocatalytic reactor;

15 FIG. 15 is a graph showing the variation in the effective photon number as the reactor radius is varied in the model shown in FIG. 14;

20 FIG. 16 is a graph showing the variation in the lighting efficiency and the effective photon number as the wattage of the light source is varied in the reactor model of FIG. 14;

FIG. 17 is a graph showing the variation in the product of the lighting efficiency and the effective photon number shown in FIG. 16;

25 FIG. 18 is a graph showing the survival rate of *Escherichia coli* subjected to photodecomposition;

FIG. 19 is a graph showing the sterilization speed vis-a-vis *Escherichia coli* under different UV intensity, with the abscissa shown in a logarithmic scale;

30 FIG. 20 is a graph showing the sterilization efficiency vis-a-vis *Escherichia coli* under different UV intensity, with the abscissa similarly shown in a logarithmic scale;

FIG. 21 is a graph showing the variation in the sterilization ability as the reactor radius is varied in the model shown in FIG. 14.

Best Mode for Carrying Out the Invention

In FIGS. 2-5, there are shown by way of example various layouts of illumination light source and photocatalyst. In the layout of FIG. 2, the side wall 10 of a room is provided with a panel 12 on which a thin film of photocatalyst is supported, whereas the ceiling 14 is equipped with commercial interior lighting fluorescent lamps 16 to irradiate the photocatalytic panel 12 thereby to excite the photocatalyst for the purposes of deodorization of the ambient air as well as for antibacterial processing of the side wall.

FIG. 3 illustrates a layout adapted to illuminate the photocatalyst at a uniform light intensity. In this layout, one side wall 18 of the room is equipped with three sets of embedded lighting fixtures 20A-20C each incorporating fluorescent lamps, not shown, with the opposite side wall 22 being provided with one or more photocatalytic panels, not shown. The central lighting fixture 20A is directed generally horizontally, with the upper and lower fixtures 20B and 20C being directed, respectively, toward the ceiling and the floor. In FIG. 3, the light intensity distribution obtained by different lighting fixtures are plotted by circular, rectangular and triangular indicia, respectively. It will be understood from the line plotted by the black dots that, in this layout, the sum of the light intensity provided by the three sets of lighting fixtures 20A-20C becomes uniform along the side wall.

FIG. 4 shows a layout for sterilizing the side walls and the ambient air of a hospital room by way of the process according to the invention. The walls of the care room are covered by tiles 24 supporting the thin film of photocatalyst and the conventional lighting fixtures 26 incorporating fluorescent lamps are disposed on the ceiling of the room.

FIG. 5 illustrates another layout wherein an environment, such as a toilet, which is subject to fouling and spoiling is kept clean by photo-decomposition of malodorous substances and splashed soiling substances. The tiles 30 disposed on the wall

and floor near the urinal 28 are covered by photocatalytic thin film and are adapted to be subjected to UV irradiation from the conventional lighting fixtures, not shown. The photocatalytic thin film may be affixed directly on sanitary earthenware such as the urinal 28, toilet stool and wash basin for disinfection of bacteria and prevention of dirty deposit.

The panel 12 and tiles 24 and 30 on which the thin film of photocatalyst is supported may be manufactured by fixing TiO_2 powders on the conventional glazed tiles. Preferably, TiO_2 powders are powders of anatase form of TiO_2 which has a band gap energy of about 3.2 eV and, accordingly, can be photoexcited by UV radiations having a wave length shorter than 387 nm. Suitable example of anatase form TiO_2 powders is TiO_2 sol (4% aqueous solution of ammonia; average particle size of 10 nm) marketed by K.K. Taki Chemical (Kakogawa-shi, Hyogo-ken, Japan). The thin film of TiO_2 may be formed by spray coating the TiO_2 sol on a prefabricated conventional glazed tile and by firing at a temperature of $780^\circ C$ which is slightly lower than the brookite (or rutile) transformation point of TiO_2 . When fired at such temperature, anatase TiO_2 particles are sintered with each other and are bonded to the molten glaze at the surface of the tile substrate as shown in FIG. 6 to form a rigid thin film when cooled. Similarly, in the case that the sanitary earthenware such as the urinal 28 per se is to be coated by the photocatalytic thin film, the TiO_2 sol may be spray coated on the previously prepared glazed sanitary earthenware, followed by firing.

The light source for photoexcitation of the photocatalyst as well as for room illumination may be selected from various commercially marketed electric lamps for general lighting applications according to the desired luminous intensity of visible and UV lights. In FIGS. 7A-7D, there are shown spectrum distribution of the conventional black light blue (BLB) fluorescent lamp, blue light fluorescent lamp, pink light fluorescent lamp and white light fluorescent lamp, respectively,

• 2127552

which are usable in the present invention. It will be noted that the light of respective fluorescent lamps includes a small amount of UV light having the wave lengths of 313 nm and 365 nm that correspond to the line spectrum of mercury. However, UV light of less than 300 nm wave length that is harmful to human bodies is never or almost never included. As the UV light of the wave lengths of 313 nm and 365 nm have an optical energy higher than the band gap energy of the anatase form TiO_2 , which band gap energy is equivalent to the wave length of 387 nm, it can be used to photoexcite the photocatalyst comprising anatase form TiO_2 . The BLB fluorescent lamp emitting a large amount of UV light having the major wave length of 352 nm may advantageously be employed in a situation in which the UV light intensity must be strengthened. Because of small UV light intensity, pink light and white light fluorescent lamps are suitable where the visible light intensity is to be increased to provide higher degree of room illumination. The light from the blue light fluorescent lamp includes a substantial amount of UV light having the light energy higher than the band gap energy of anatase. These fluorescent lamps mentioned above may be used solely or in combination with other fluorescent lamps and other type of electric lamp.

Throughout the various layouts shown in FIGS. 2-5, the distance between the lighting fixtures and the photocatalytic thin film as well as the wattage of the lighting fixtures are determined in such a manner that the light intensity of UV light having the light energy higher than the band gap energy of photocatalyst is $0.001-1 \text{ mW/cm}^2$, preferably, $0.01-0.1 \text{ mW/cm}^2$. The power of the room light utilized for photocatalytic excitation may also be determined taking into account the UV energy of the solar light which may shine into the room during the day time.

As the light source is turned on so that the thin film of photocatalyst is photoexcited by the UV light, the surface hydroxyl group is oxidized into OH radical ($\cdot\text{OH}$) and the surface

• 2127552

oxygen reduced into superoxide ion (O_2^-) due to the redox action of generated electrons and holes. As these species are highly active, substances or bacteria brought into contact with the surface of the thin film 38 are decomposed or killed. In this regard, it is considered that bacteria such as *Escherichia coli*, *Pseudomonas aeruginosa* and *Staphylococcus* are killed because protein forming the cell membrane thereof is chemically decomposed by these active species whereby the cell membrane is physically destroyed.

Example 1

The afore-mentioned TiO_2 sol marketed from K.K. Taki Chemical was spray coated on an alumina substrate (about 10 X 10 cm) of about 96% alumina prepared by Nippon Carbide Industries Co., Inc. and the substrate was fired at 780°C to produce a tile on which is formed a thin film of anatase form TiO_2 having a thickness of about 1 μm . The porosity of the TiO_2 thin film was about 40% and the specific surface thereof was 17.5 m^2/g .

The tile 40 thus fabricated was placed in an 11-litre desiccator 42 made of UV permeable quartz glass, as shown in FIG. 8, and was photoexcited by various light sources under UV radiations of varying intensity for testing the decomposition capability thereof against methyl mercaptan (CH_3SH) being one of the malodorous substances. In each run, either about 0.5 or 2 litres of nitrogen gas containing 100 ppm of methyl mercaptan was introduced into the desiccator. The methyl mercaptan content in the desiccator was about 3-5 ppm or 20 ppm. Inside of or outside of the desiccator, a 20-W pink light fluorescent lamp (made by Toshiba; FL20SPK), a 20-W white light fluorescent lamp (made by Toshiba; FL20SW), a 20-W blue light fluorescent lamp (made by Toshiba; FL20SB), and a 4-W BLB fluorescent lamp (made by Sankyo Electric; FL4BLB) are positioned, respectively, in such a manner that the UV light intensity in the wave length range of 300-390 nm is 8 $\mu W/cm^2$, 11 $\mu W/cm^2$, 48 $\mu W/cm^2$, and 295 $\mu W/cm^2$, respectively. For higher UV intensity of 2-20 mW/cm^2 , a 200-W

• 2127552

mercury xenon lamp (made by Yamashita Denso; SUNCURE 202) was used while adjusting the output. Gas in the desiccator was periodically sampled for measurement of methyl mercaptan content by way of a gas chromatograph.

5 In the graph of FIG. 9, there is shown the variation in the methyl mercaptan content when UV irradiation was carried out by the pink light fluorescent lamp ($8 \mu\text{W}/\text{cm}^2$ UV intensity), blue light fluorescent lamp ($48 \mu\text{W}/\text{cm}^2$), and BLB fluorescent lamp ($295 \mu\text{W}/\text{cm}^2$), respectively. Variation in the methyl mercaptan content
10 taken place without UV irradiation is also shown. It will be noted that the methyl mercaptan content decreases without UV irradiation. It is believed this is because methyl mercaptan is physically absorbed by the TiO_2 thin film. From the graph of FIG. 9, it will be understood that, higher the UV light intensity
15 in the wave length range of 300-390 nm, higher is the yield of photodecomposition of methyl mercaptan.

The photodecomposition speed of methyl mercaptan was calculated based on the variation in the methyl mercaptan content measured in each run. The results are plotted in the graph of
20 FIG. 10. From the graph, it will be noted that the decomposition speed of methyl mercaptan generally increases with increasing UV intensity. It seemed, however, that the speed of decomposition did not continue to increase even when the UV intensity exceeded $2 \text{ mW}/\text{cm}^2$. Obviously, this is contrary to the common knowledge
25 and understanding admitted in the prior art that the reaction yield increases as long as the UV intensity is increased.

In an attempt to investigate the reasons of this fact, the present inventors have tentatively calculated the quantum yield of photons absorbed by the photocatalyst. To this end, although
30 how many electrons are involved in the decomposition of a molecule of methyl mercaptan is not known with any certainty, the present inventors have presumed that the photodecomposition of methyl mercaptan is a 6-electron process, and sought the quantum yield (%) according to the following equation.

$$\text{quantum yield} = \frac{\text{total number of decomposed CH}_3\text{SH molecules}}{\text{number of photons absorbed by photocatalyst}} \times 6 \times 100$$

The results of calculation are plotted in the graph of FIG. 11. As will be apparent from the graph, the present inventors have found that the quantum yield increases with decreasing UV intensity. It was noted that at UV intensity of $8 \mu\text{W}/\text{cm}^2$, a remarkable quantum efficiency as high as about 36% was accomplished.

To ascertain to what degree the photons absorbed by the photocatalyst have actually been effectively utilized in the decomposition of methyl mercaptan, the photon density per second was first computed and then the effective photon density - to be termed as the product of the quantum yield multiplied by the photon density per second and representing the number of photons per unit surface area that have actually contributed in photodecomposition - was calculated based on the photon density per second. The UV intensity shown along the abscissa of FIG. 11 was calculated in terms of the photon density per second and the results are plotted in the graph of FIG. 12. In the graph of FIG. 13, the effective photon density is plotted according to varying UV intensity. The graph of FIG. 13 means that, with the photocatalyst of anatase form TiO_2 thin film, the effective photon density attains to the maximum value of 4×10^{13} (photon/ $\text{cm}^2 \cdot \text{sec}$) as the UV intensity reaches $2 \text{ mW}/\text{cm}^2$ and that, thereafter, excessive electrons and holes generated are subjected to recombination without contributing in the decomposition of methyl mercaptan even though the UV intensity is increased further.

To compare with the powder system, a ceramic substrate on which powders of anatase form TiO_2 were loosely deposited was placed in the desiccator 42 and was tested for photodecomposition of methyl mercaptan by circulating a nitrogen gas containing 3-5 ppm of methyl mercaptan. The results are shown in the following table.

Light Source (Fluorescent Lamp)	UV Intensity ($\mu\text{W}/\text{cm}^2$)	Quantum Yield (%)	Effective Photon Density ($\text{N}/\text{sec}\cdot\text{cm}^2$)
White Light	51.4	24.4	2.3×10^{14}
BLB	1690	1.7	5.3×10^{14}

As will be apparent from the above table, in the powder system, the effective photon density is in the order of 10^{14} which is ten times higher as compared with the thin film system. This means that in the powder system it is desirable to carry out photodecomposition process under higher UV intensity.

Next, the optimum range of UV intensity will be discussed based on the effective photon density shown in the graph of FIG. 13. To this end, a cylindrical reactor model as shown in FIG. 14 will be considered, since a room lined with photocatalytic thin film may be regarded as a photocatalytic reactor. The reactor model has a radius r and a height H ($H = 1 \text{ m}$) and is provided with a light source arranged at the center thereof and with photocatalyst disposed on the cylindrical inner wall. Assuming that the light source is of a predetermined output, when the reactor radius r is increased, the surface area of the photocatalytic thin film will be increased in proportion to the radius but the UV intensity on the thin film will be decreased roughly in inverse proportion to the square of the distance. The number of effective photons that have actually contributed in the photocatalytic reaction in the reactor as a whole is equal to the product of the effective photon density multiplied by the surface area of the thin film (effective photon number = effective photon density \times thin film surface area), whereas the effective photon density varies in response to the change in the UV intensity as shown in the graph of FIG. 13. Assuming that two 40-W BLB fluorescent lamps are used as the light source, the variation in the effective photon number as the reactor radius r is changed was calculated based on the effective photon density shown in FIG. 13. The results are shown in the graph of FIG. 15. As will be understood from this graph, as the UV intensity becomes

excessive, the effective photon number, which represents the reaction yield of the reactor as a whole, decreases. This is due to the fact that the quantum yield of photon decreases with increasing UV intensity. The graph of FIG. 15 indicates that the UV intensity range which is most effective from the view point of achieving a high reaction yield of the reactor is 0.001-1 mW/cm², preferably, 0.01-0.1 mW/cm².

The relationship between the reaction yield and the electric power consumption in the model of FIG. 14 will be discussed next. Assuming the radius r to be 1 meter and assuming that the wattage of the fluorescent lamps serving as the light source is varied, the lighting efficiency of the fluorescent lamps was calculated according to the following equation.

$$\text{lighting efficiency} = \frac{\text{effective photon number}}{\text{power consumption of lamps}}$$

The lighting efficiency thus obtained is shown by the curve A in the graph of FIG. 16. As the curve A indicates, the number of effective photons per watt of fluorescent lamps decreases with increasing UV intensity. Also shown in FIG. 16 is the effective photon number which is plotted by the curve B. The product of the lighting efficiency multiplied by the effective photon number was calculated and shown in the graph of FIG. 17. It will be noted that the tendency shown in the graph of FIG. 17 is generally consistent with that of FIG. 15. The graph of FIG. 17 indicates that, in order to obtain the maximum reactor yield with least power consumption, it is also desirable to use the UV intensity of 0.001-1 mW/cm², preferably, 0.01-0.1 mW/cm².

Example 2

Tiles coated respectively with a thin film of anatase form TiO₂ similar to that used in Example 1 were tested to examine the sterilizing effect thereof against *Escherichia coli* (W3110 stock). To this end, liquid cultures prepared by shake cultivation for a night were subjected to centrifugal washing and diluted with sterilized distilled water by 10,000 times to prepare bacteria containing liquid. 0.15 ml of the bacteria

2127552

containing liquid (equivalent to $1-5 \times 10^4$ CFU) was dropped on respective photocatalytic tiles which had previously been sterilized by 70% ethanol and each tile was intimately covered by a glass plate (10 x 10 cm) to provide a specimen.

5 In each run, two such specimens were used, with the one subjected to irradiation under varying light intensity, with the other kept in the dark for the purposes of comparison. Irradiation was carried out in such a manner that the UV light intensity in the wave length range of 300-390 nm is $0.8 \mu\text{W}/\text{cm}^2$,
10 $1.7 \mu\text{W}/\text{cm}^2$, $2.7 \mu\text{W}/\text{cm}^2$, $13 \mu\text{W}/\text{cm}^2$, $350 \mu\text{W}/\text{cm}^2$, $10 \text{mW}/\text{cm}^2$, and $20 \text{mW}/\text{cm}^2$, respectively. For irradiation at less than $13 \mu\text{W}/\text{cm}^2$ intensity, at $350 \mu\text{W}/\text{cm}^2$ intensity, and at more than $10 \text{mW}/\text{cm}^2$ intensity, a 20-W white light fluorescent lamp (made by Toshiba; FL20SW), a 20-W BLB fluorescent lamp (made by Sankyo Electric;
15 FL20BLB), and a 200-W mercury xenon lamp (made by Yamashita Denso; SUNCURE 202) were used, respectively.

After irradiation for a predetermined time, the bacteria containing liquid of both the irradiated specimen and the specimen kept in the dark was wiped by a sterilized gauze and was
20 recovered in 10 ml of physiological saline. The bacteria containing liquid thus recovered was applied for inoculation either on a nutrient agar plate (Nissui Pharmaceuticals) or desoxycholate agar plate (Nissui Pharmaceuticals) and was cultured at 37°C for a day. Thereafter, the colonies of
25 *Escherichia coli* formed on the culture was counted to obtain the number of bacteria in terms of colony formed unit (CFU). Then, the survival rate of *Escherichia coli* was sought by calculating the ratio of the number of bacteria of the irradiated specimen with respect to that of the specimen kept in the dark. The
30 results are shown in the graph of FIG. 18. This graph shows that, even under such a weak UV intensity of as small as $0.8 \mu\text{W}/\text{cm}^2$, the number of *Escherichia coli* is decreased down to about one tenth upon four hours of irradiation so that the photocatalyst exhibits a sufficient sterilizing capability
35 required for practical applications.

Then, the speed of sterilization per tile for different UV intensities was calculated from the resulting data and the results are shown in the graph of FIG. 19. It will be noted from the graph that the speed of sterilization reaches to a steady state condition as the UV intensity is increased. Further, the efficiency of sterilization defined by the following equation was calculated for different UV intensities.

$$\text{sterilization efficiency} = \frac{\text{number of } \textit{Escherichia coli} \text{ killed by irradiation}}{\text{number of photons absorbed by the photocatalyst}}$$

The results are shown in the graph of FIG. 20. It will be noted that this graph is generally in commensurate with the graph of FIG. 11 wherein the quantum yield attained during photo-decomposition of methyl mercaptan is shown and that the number of killed bacteria per photon increases with decreasing UV intensity.

Then, based on the sterilization efficiency thus obtained, the number of bacteria which would be killed each second in the reactor model shown in FIG. 14 was tentatively calculated for varying reactor radius r , assuming that the output of the light source is constant (two 40-W white light fluorescent lamps). The results of calculation is shown in the graph of FIG. 21. From the graph, it will be understood that a high degree of sterilization capability of the reactor will be achieved when the UV intensity is in the range of 0.01-0.1 mW/cm^2 or in the vicinity thereof.

CLAIMS

1. A photocatalytic process for the treatment of contaminated air in an indoor space, said process comprising the
5 steps of:

a) disposing at least one electric lamp to illuminate said space;

b) providing a thin film of photocatalyst of solid-state semiconductor material on at least a part of the interior surface
10 of said space in a light receiving relationship from said lamp;

said lamp being an electric lamp for general lighting applications adapted to emit light substantially having the wave length not less than 300 nm, said lamp being capable of emitting at least a small amount of ultraviolet radiations within the wave
15 length range between 300 nm and the wave length corresponding to the band gap energy of said semiconductor material;

the wattage of said electric lamp and the distance between said thin film and said lamp being selected such that, when said lamp is energized, the total incident light intensity, impinging
20 upon said thin film, of ultraviolet radiations within said wave length range is 0.001-1 mW/cm²; and,

c) energizing said lamp whereby said thin film of photocatalyst is photoexcited.

25 2. A process according to claim 1, wherein said semiconductor material comprises titanium dioxide and wherein said thin film of photocatalyst is made of sintered powders of titanium dioxide.

30 3. A process according to claim 2, wherein said thin film is supported on a ceramic substrate affixed to the interior surface of said space.

4. A process according to claim 3, wherein said ceramic substrate is a glazed tile and wherein said powers of titanium dioxide are bonded to said glaze.

5 5. A process according to claim 1, wherein said thin film of photocatalyst comprises powders of titanium dioxide fixed by a binder to a substrate.

10 6. A process according to one of claims 1-5, wherein the thickness of said thin film is 0.3-10 micrometers.

15 7. A process according to one of claims 1-6, wherein said semiconductor material comprises the anatase form of titanium dioxide.

8. A process according to one of claims 1-6, wherein said semiconductor material comprises metalized rutile form of titanium dioxide.

20 9. A process according to one of claims 1-8, wherein said total incident light intensity is 0.1-0.01 mW/cm².

25 10. A process according to one of claims 1-9, wherein said electric lamp is a low-pressure mercury fluorescent lamp capable of emitting light including ultraviolet radiations having the wave lengths of about 313 and 365 nm.

30 11. A process according to one of claims 1-9, wherein said electric lamp is a low-pressure mercury fluorescent lamp capable of emitting ultraviolet radiations having the major wave length of 350-360 nm.

35 12. A process according to one of claims 1-9, wherein said electric lamp is a high intensity discharge lamp.

13. A process according to claim 12, wherein said high intensity discharge lamp is a metal halide lamp.

14. A process according to one of claims 1-9, wherein said electric lamp is an incandescent lamp.

15. A photocatalytic sterilization process for a walled environment wherein airborne bacteria are present, said process comprising the steps of:

10 lining at least a part of said wall with a thin film of photocatalyst made of sintered powders of titanium dioxide;

disposing at least one electric lamp for general lighting applications in a light emitting relationship against said thin film; and,

15 energizing said lamp to photoexcite said thin film of photocatalyst;

said electric lamp being adapted to emit light substantially having the wave length not less than 300 nm and being capable of emitting at least a small amount of ultraviolet radiations within the wave length range of 300-390 nm;

20 the wattage of said electric lamp and the distance between said thin film and said lamp being selected such that the total incident light intensity, per unit surface area of said thin film, of ultraviolet radiations within the wave length range of 300-390 nm is 0.001-1 mW/cm².

16. A photocatalytic process for sterilizing bacterium-contaminated air in a medical facility, said process comprising the steps of:

30 covering at least a part of the interior surface of said facility with a thin film of photocatalyst of sintered powders of titanium dioxide;

disposing at least one electric lamp for general lighting applications in a light emitting relationship against said thin film; and,

35

energizing said lamp to photoexcite said thin film of photocatalyst;

said electric lamp being adapted to emit light substantially having the wave length not less than 300 nm and being capable of emitting at least a small amount of ultraviolet radiations within the wave length range of 300-390 nm;

the wattage of said electric lamp and the distance between said thin film and said lamp being selected such that the total incident light intensity, per unit surface area of said thin film, of ultraviolet radiations within the wave length range of 300-390 nm is 0.001-1 mW/cm².

17. A photocatalytic antibacterial treatment process for a walled living environment, said process comprising the steps of:

lining at least a part of said wall with a thin film of photocatalyst made of sintered powders of titanium dioxide;

disposing at least one electric lamp for general lighting applications in a light emitting relationship against said thin film; and,

energizing said lamp to photoexcite said thin film of photocatalyst;

said electric lamp being adapted to emit light substantially having the wave length not less than 300 nm and being capable of emitting at least a small amount of ultraviolet radiations within the wave length range of 300-390 nm;

the wattage of said electric lamp and the distance between said thin film and said lamp being selected such that the total incident light intensity, per unit surface area of said thin film, of ultraviolet radiations within the wave length range of 300-390 nm is 0.001-1 mW/cm².

18. A photocatalytic antibacterial treatment process for a walled food processing environment, said process comprising the steps of:

lining at least a part of said wall with a thin film of photocatalyst made of sintered powders of titanium dioxide;

disposing at least one electric lamp for general lighting applications in a light emitting relationship against said thin film; and,

energizing said lamp to photoexcite said thin film of photocatalyst;

said electric lamp being adapted to emit light substantially having the wave length not less than 300 nm and being capable of emitting at least a small amount of ultraviolet radiations within the wave length range of 300-390 nm;

the wattage of said electric lamp and the distance between said thin film and said lamp being selected such that the total incident light intensity, per unit surface area of said thin film, of ultraviolet radiations within the wave length range of 300-390 nm is 0.001-1 mW/cm².

19. A photocatalytic process for the deodorization of polluted air in a walled living environment, said process comprising the steps of:

lining at least a part of said wall with a thin film of photocatalyst made of sintered powders of titanium dioxide;

disposing at least one electric lamp for general lighting applications in a light emitting relationship against said thin film; and,

energizing said lamp to photoexcite said thin film of photocatalyst;

said electric lamp being adapted to emit light substantially having the wave length not less than 300 nm and being capable of emitting at least a small amount of ultraviolet radiations within the wave length range of 300-390 nm;

the wattage of said electric lamp and the distance between said thin film and said lamp being selected such that the total incident light intensity, per unit surface area of said thin

film, of ultraviolet radiations within the wave length range of 300-390 nm is 0.001-1 mW/cm².

20. A photocatalytic process for the decomposition of
5 airborne contaminants in a walled living environment, said process comprising the steps of:

lining at least a part of said wall with a thin film of photocatalyst made of sintered powders of TiO₂;

10 disposing at least one electric lamp for general lighting applications in a light emitting relationship against said thin film; and,

energizing said lamp to photoexcite said thin film of photocatalyst;

15 said electric lamp being adapted to emit light substantially having the wave length not less than 300 nm and being capable of emitting at least a small amount of ultraviolet radiations within the wave length range of 300-390 nm;

20 the wattage of said electric lamp and the distance between said thin film and said lamp being selected such that the total incident light intensity, per unit surface area of said thin film, of ultraviolet radiations within the wave length range of 300-390 nm is 0.001-1 mW/cm².

21. A photocatalytic process for the decomposition of
25 deposits tending to foul a wall of an indoor space, said process comprising the steps of:

lining at least a part of said wall with a thin film of photocatalyst made of sintered powders of titanium dioxide;

30 disposing at least one electric lamp for general lighting applications in a light emitting relationship against said thin film; and,

energizing said lamp to photoexcite said thin film of photocatalyst;

35 said electric lamp being adapted to emit light substantially having the wave length not less than 300 nm and being capable of

emitting at least a small amount of ultraviolet radiations within the wave length range of 300-390 nm;

the wattage of said electric lamp and the distance
5 between said thin film and said lamp being selected such that the total incident light intensity, per unit surface area of said thin film, of ultraviolet radiations within the wave length range of 300-390 nm is 0.001-1 mW/cm².

10 22. A process for sterilizing a surface of a sanitary earthenware or decomposing a substance deposited on said surface, comprising the steps of: forming a thin film of photocatalyst of sintered powders of titanium
15 sanitary earthenware; and irradiating said earthenware by an electric lamp for general lighting applications in such a manner that the total light intensity of ultraviolet radiations within the wave length range of 300-390 nm is 0.001-1 mw/cm².

20

23. A room having a photocatalytic function, said room comprising:

enclosing surfaces including vertical walls, a floor and a ceiling defining an interior for the room;

25 a thin film of a photocatalytic semiconductor material having a band gap energy and covering at least a part of the enclosing surfaces of the room;

an electric lamp mounted on one of said enclosing surfaces in a position whereby said semiconductor
30 material is in a light receiving relationship with said lamp, said lamp being an electric lamp for general lighting applications emitting a visible light for illumination and at least a small amount of ultraviolet radiation within the wavelength range between 300 nm and

the wavelength corresponding to the band gap energy of said semiconductor material, the wattage of said electric lamp and the distance between said semiconductor material and said lamp being such that, when said lamp is energized, the total incident light intensity, impinging upon said semiconductor material, of said ultraviolet radiation within said wavelength range is 0.001 to 1 mW/cm².

10

24. A room according to claim 23, wherein said thin film is impinged by said ultraviolet radiation with an intensity of 0.1-0.01 mW/cm².

15

25. A room according to claim 23, wherein said electric lamp is mounted on said ceiling.

26. A room according to claim 23, which is a hospital room.

20

27. A room according to claim 23, wherein said electric lamp is a low-pressure mercury fluorescent lamp capable of emitting light including ultraviolet radiation having wavelengths of about 313 and 365 nm.

25

28. A room according to claim 23, wherein said electric lamp is a low-pressure mercury fluorescent lamp capable of emitting light including ultraviolet radiation having a wavelength of 350-360 nm

30

29. A room according to claim 23, wherein said electric lamp is a high intensity discharge lamp.

30. A room according to claim 29, wherein said high intensity discharge lamp is a metal halide lamp.

5 31. A room according to claim 23, wherein said electric lamp is an incandescent lamp.

10 32. A room according to claim 23, wherein said semiconductor material comprises the anatase form of titanium dioxide.

33. A room according to claim 23, wherein the thickness of said thin film is about 0.3-10 micrometers.

15 34. A room according to claim 23, wherein said thin film of titanium dioxide is supported on a substrate affixed to at least said part of said enclosing surfaces:

20 35. A process according to claim 34, wherein said substrate is a glazed ceramic tile.

25 36. A room according to claim 23, wherein said semiconductor material comprises metalized particles of the rutile form of titanium dioxide.

30 37. A glazed ceramic bathroom fixture selected from the group consisting of urinals, wash basins and toilet bowls, said bathroom fixture having a surface at least partially covered with a thin film of a photocatalytic semiconductor material.

38. A glazed ceramic bathroom fixture according to claim 37 wherein said semiconductor material comprises

anatase.

39. A glazed ceramic bathroom fixture according to
5 claim 37 wherein the thickness of said thin film is about
0.3-10 micrometers.

FIG. 1

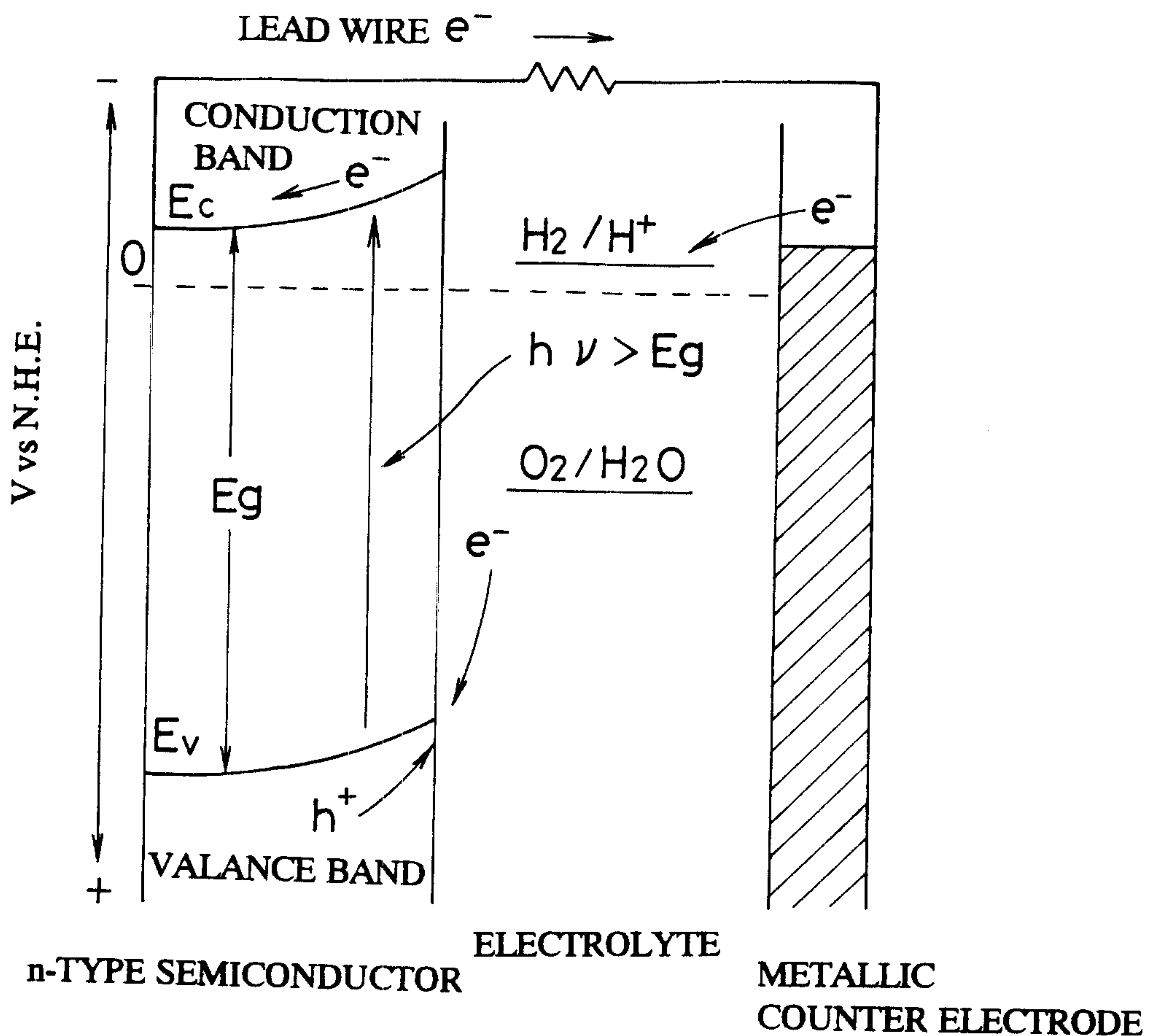

FIG. 6

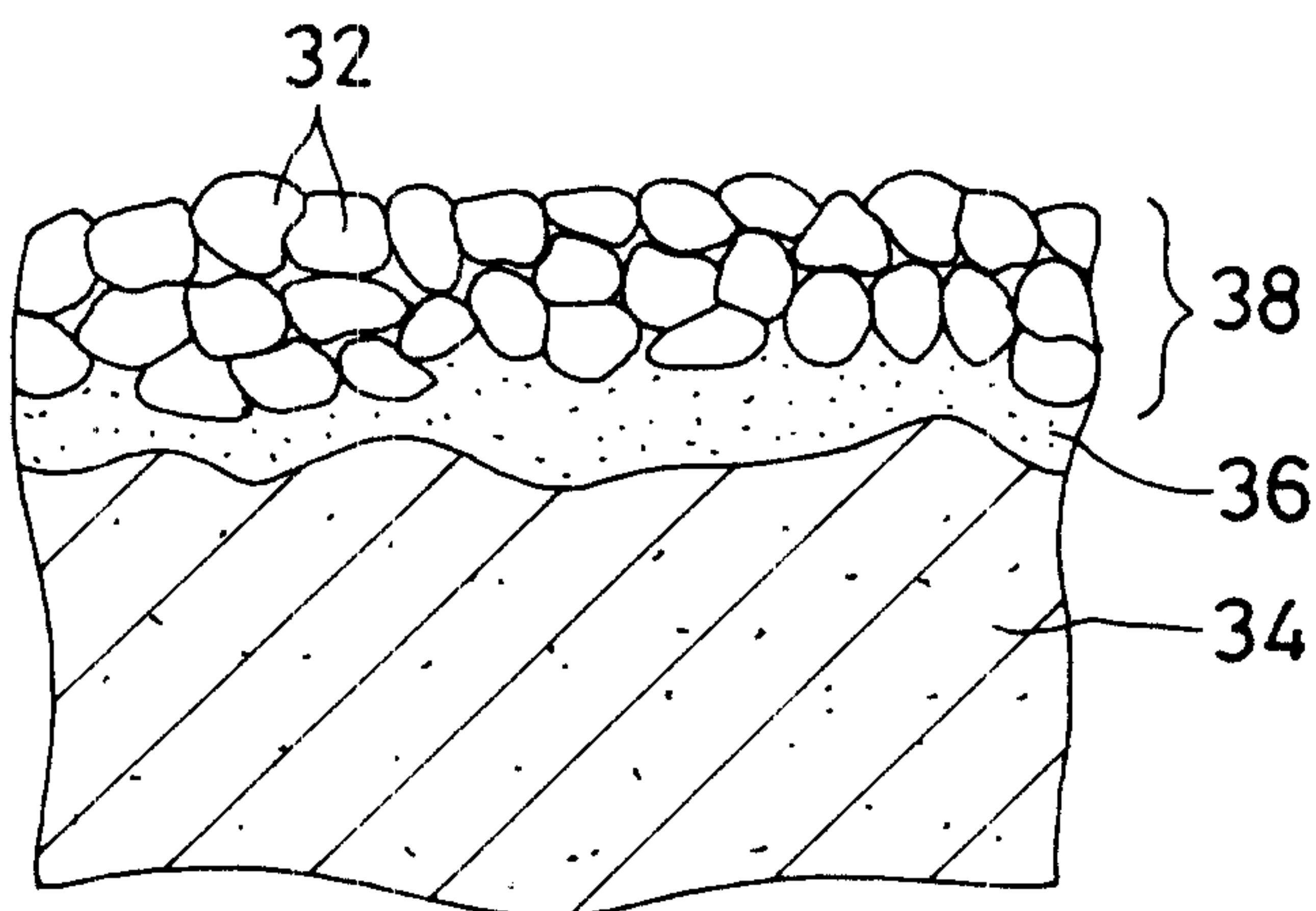

FIG. 2

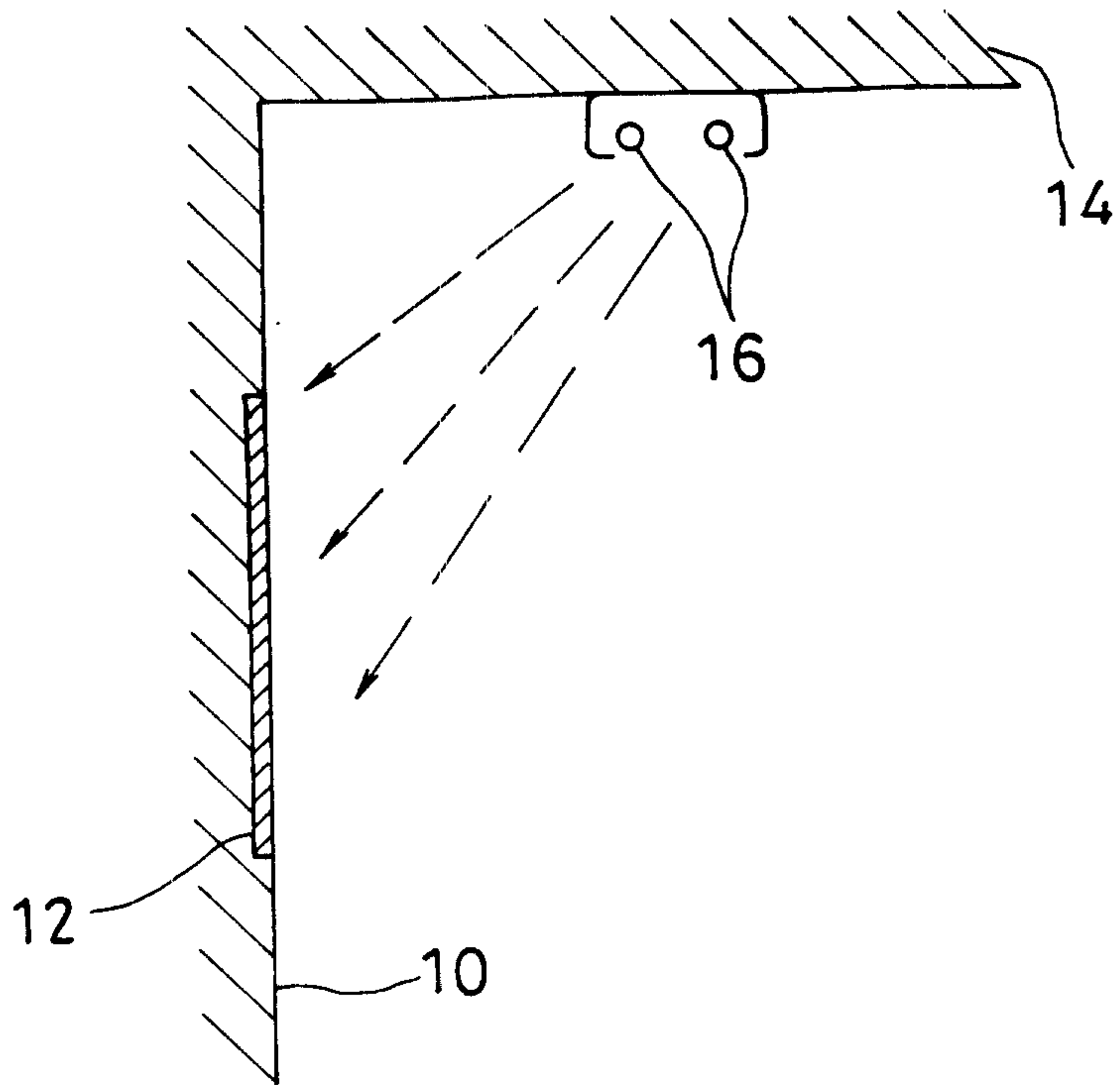

FIG. 3

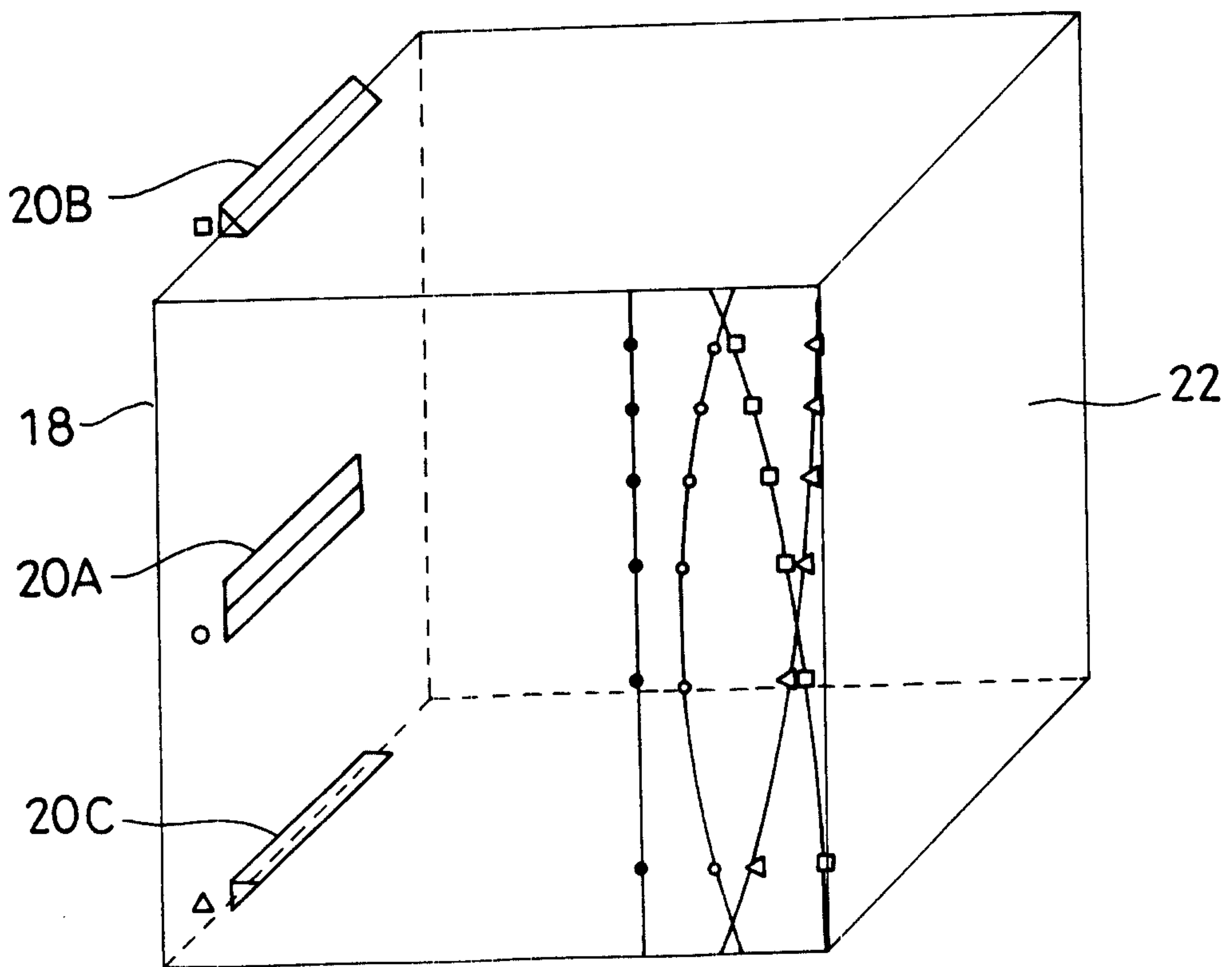

FIG. 4

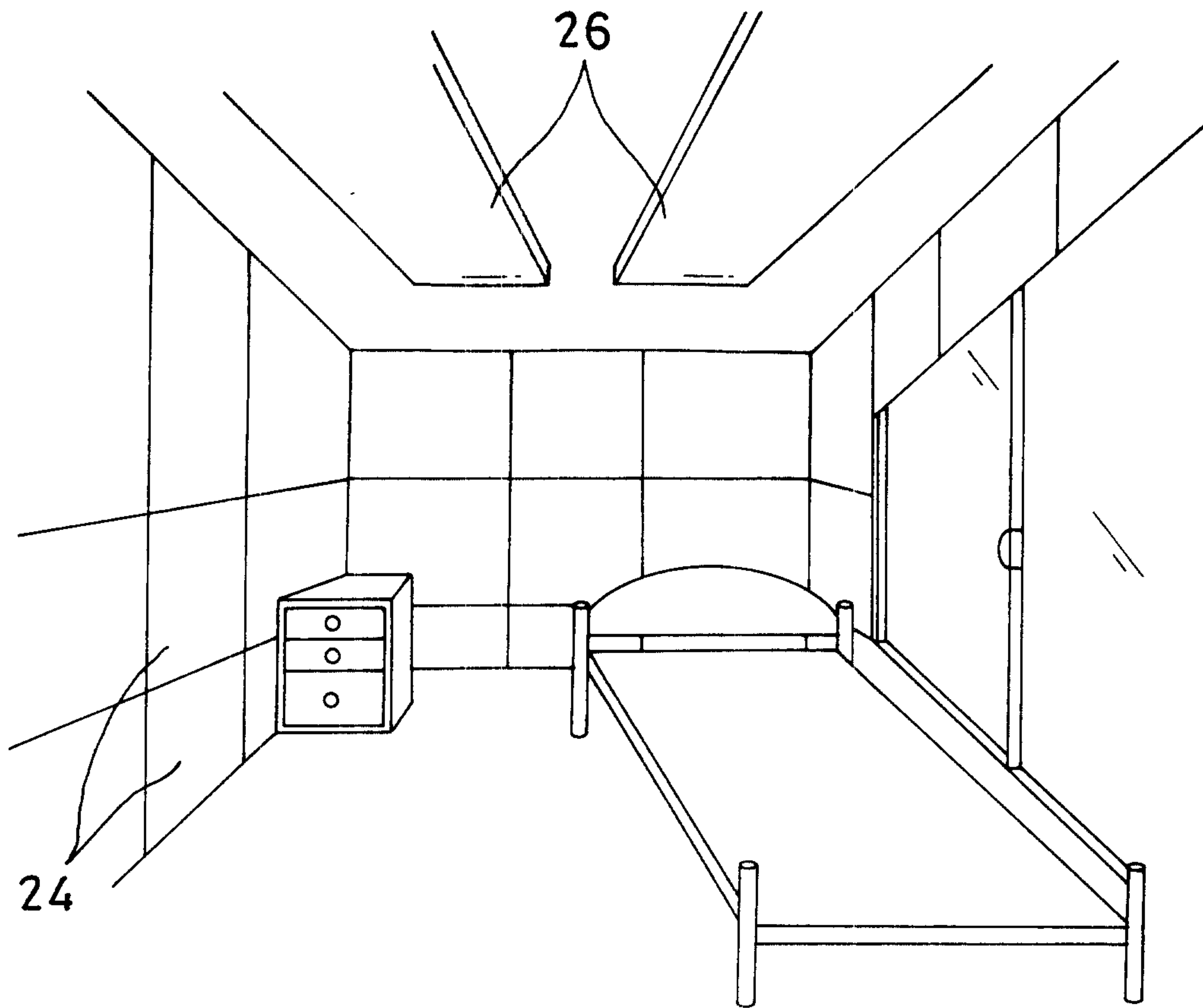

FIG. 5

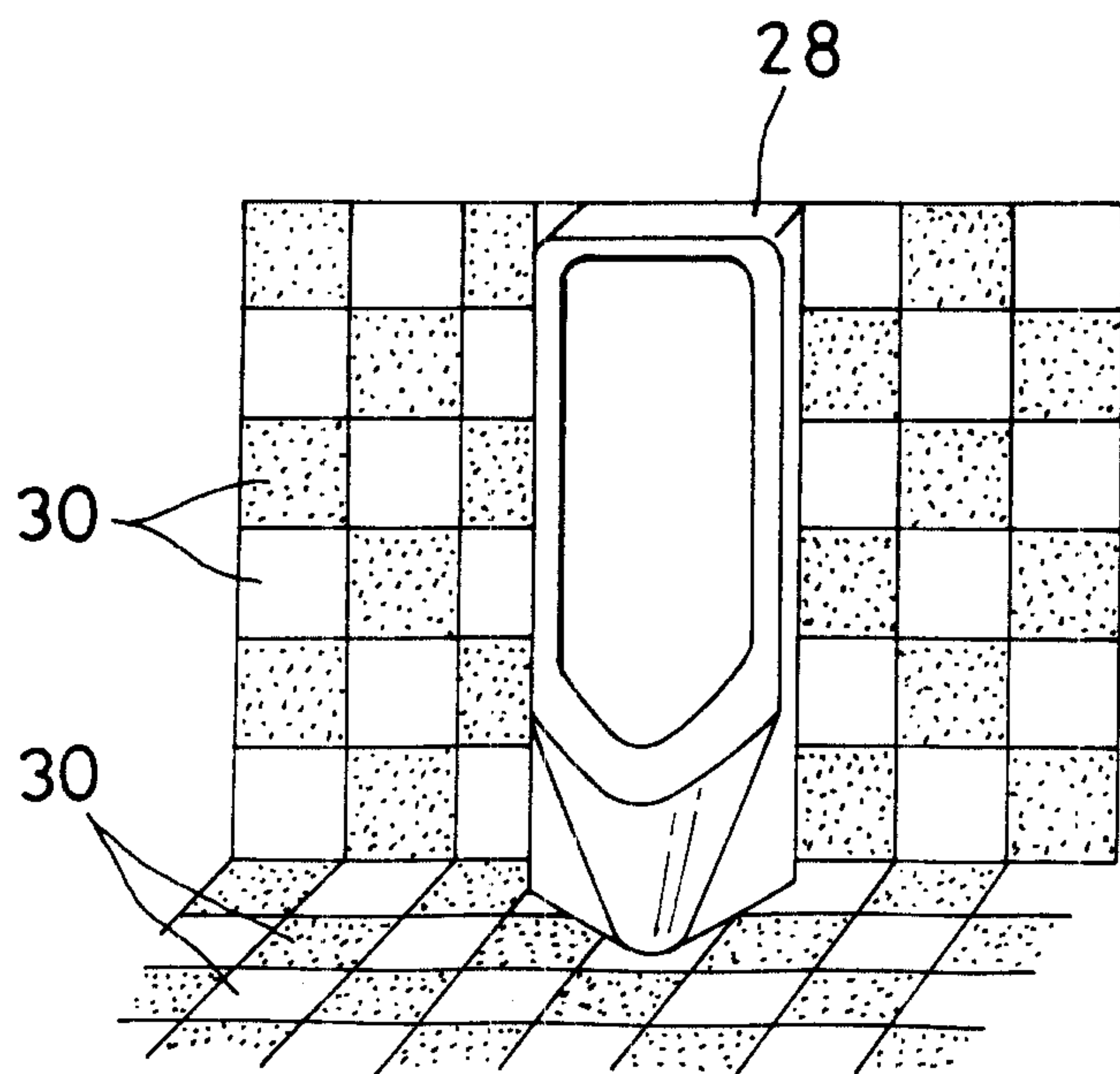

FIG. 7A

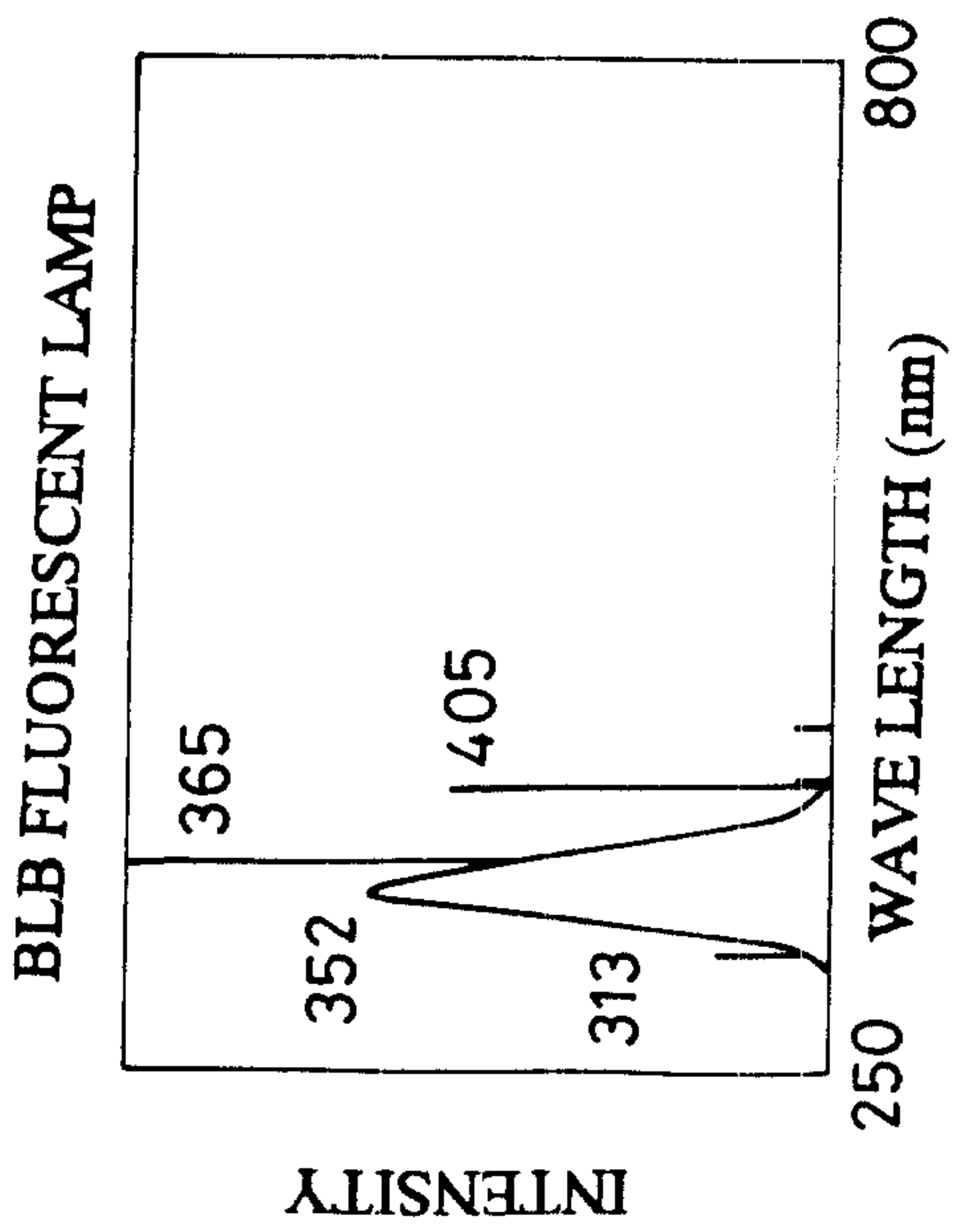

FIG. 7C

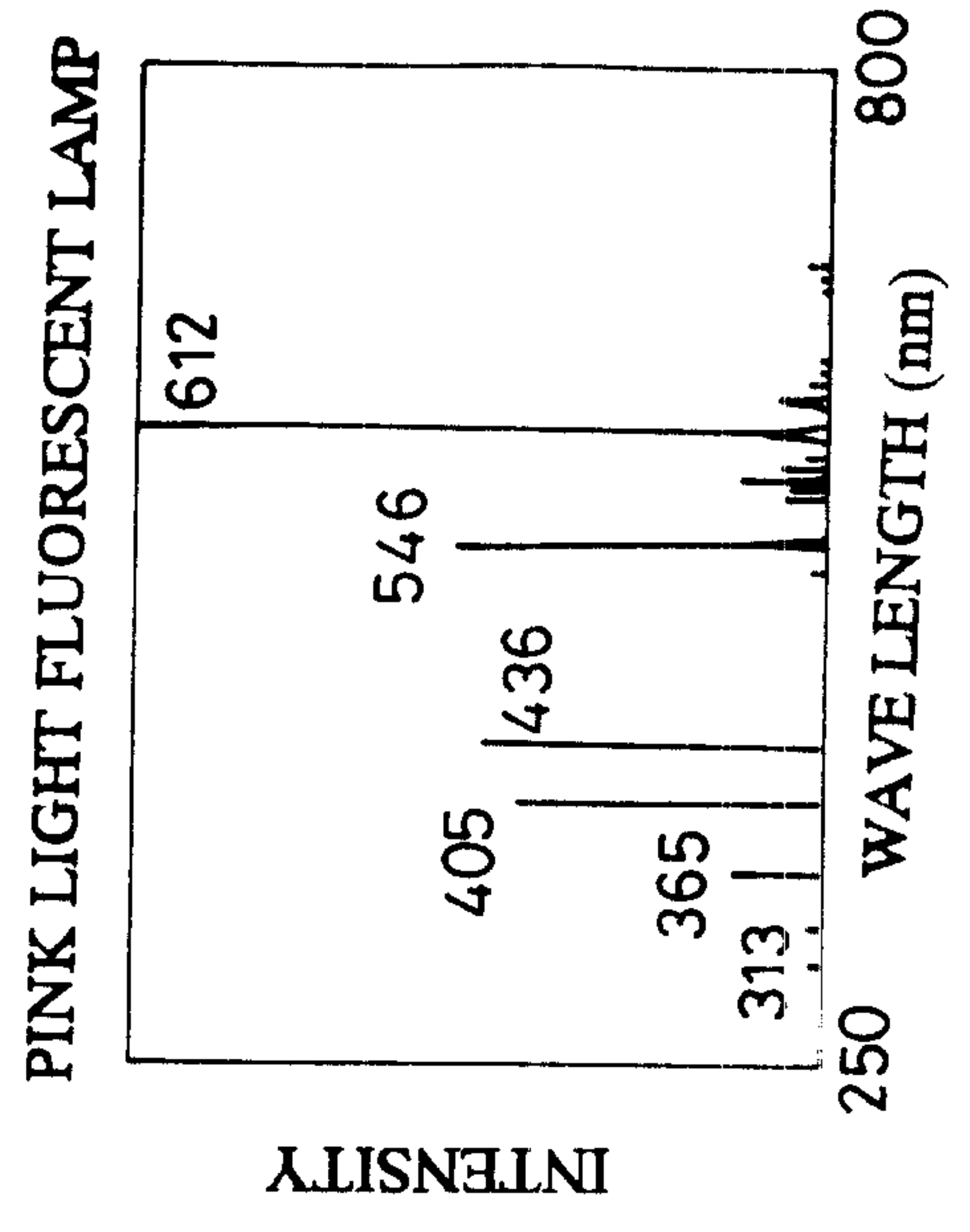

FIG. 7B

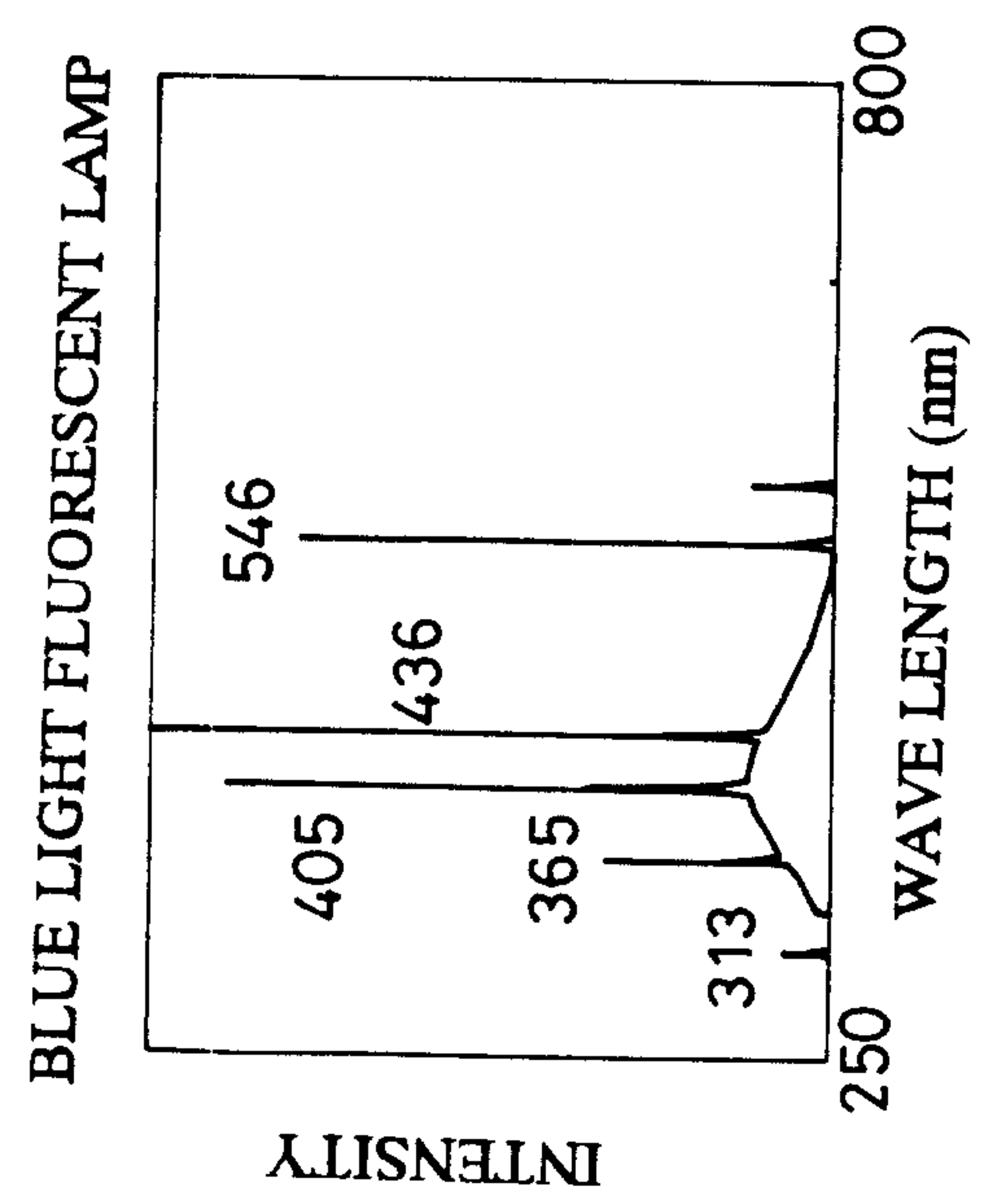

FIG. 7D

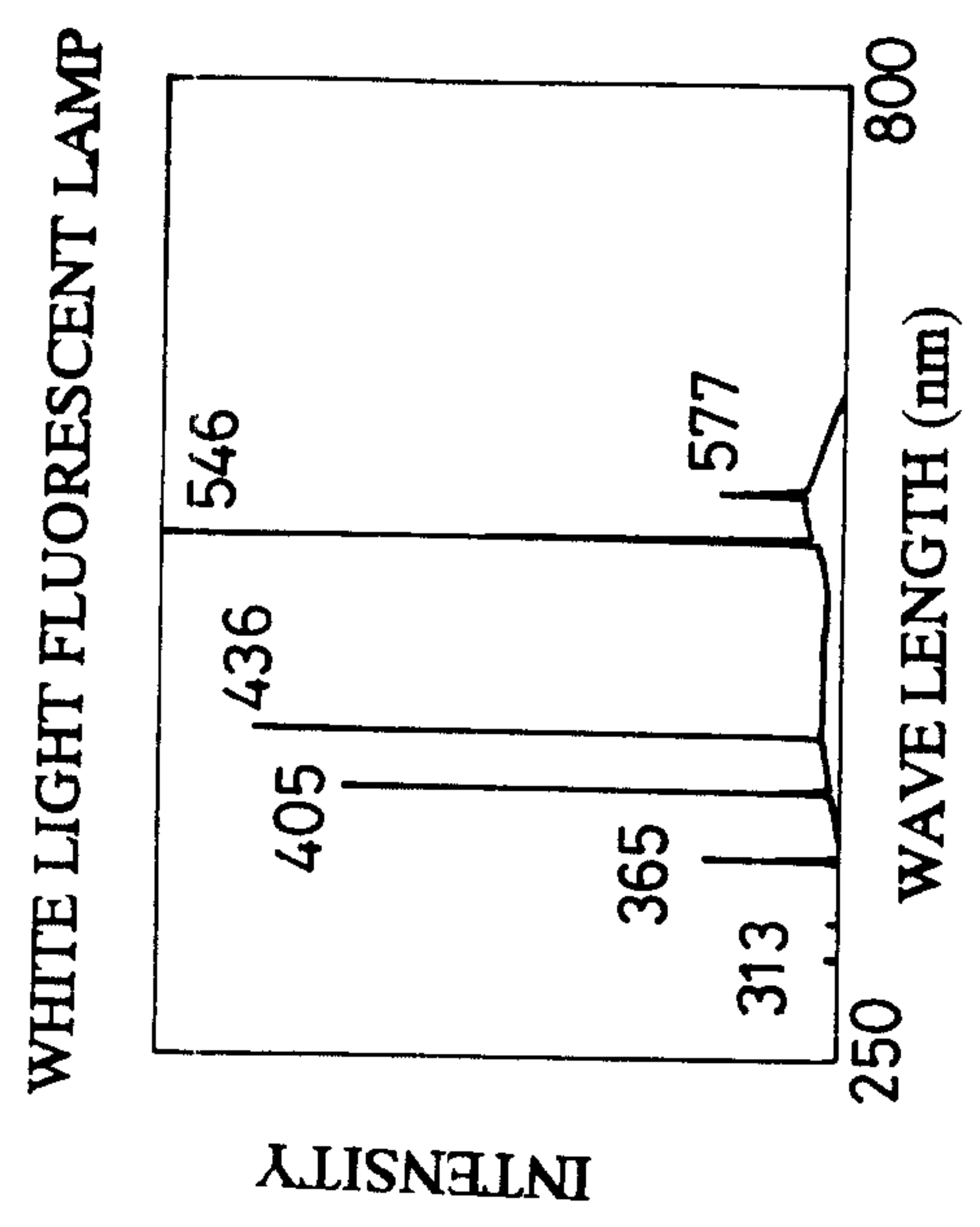

FIG. 8

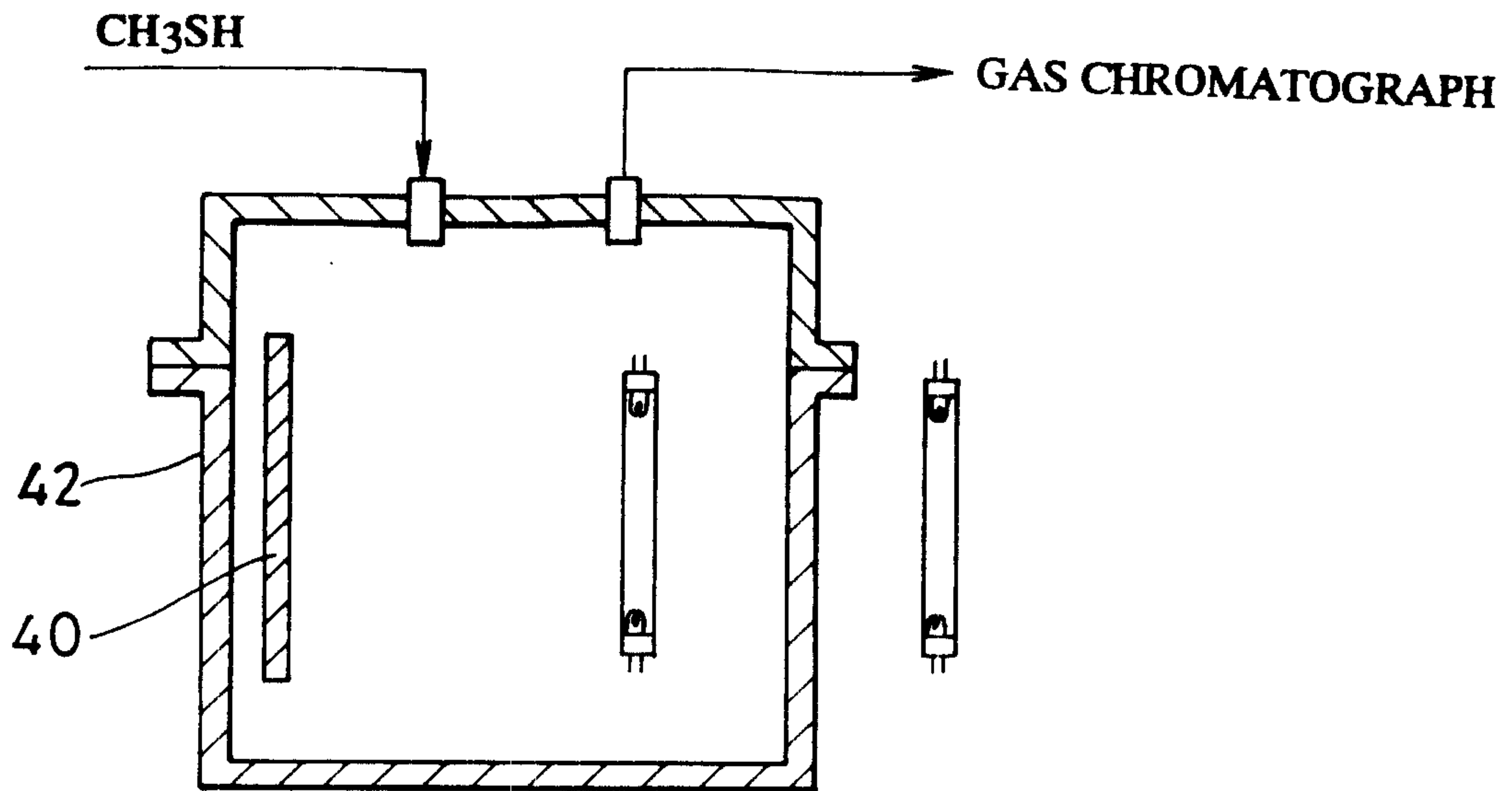

FIG. 9

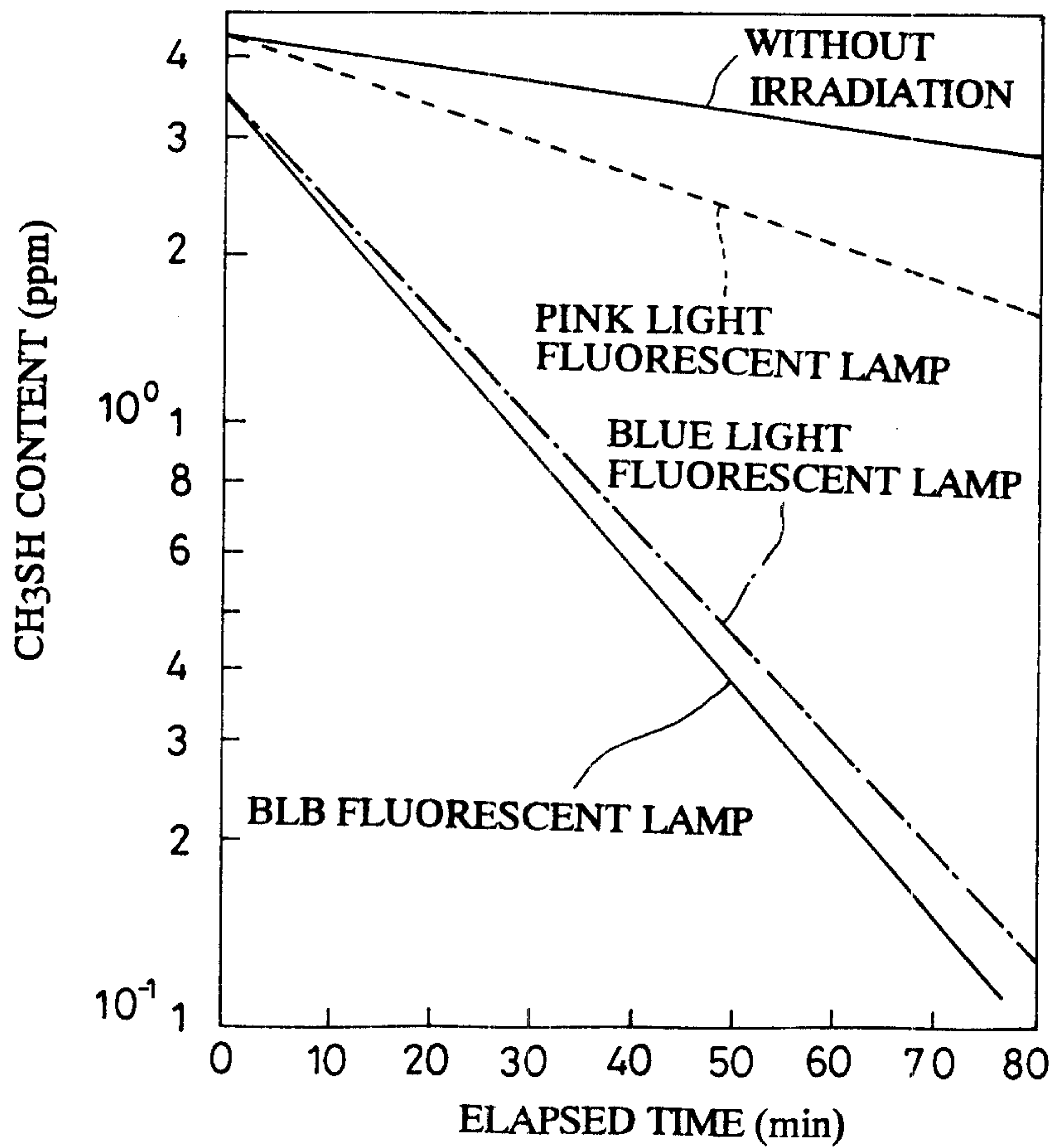

FIG. 10

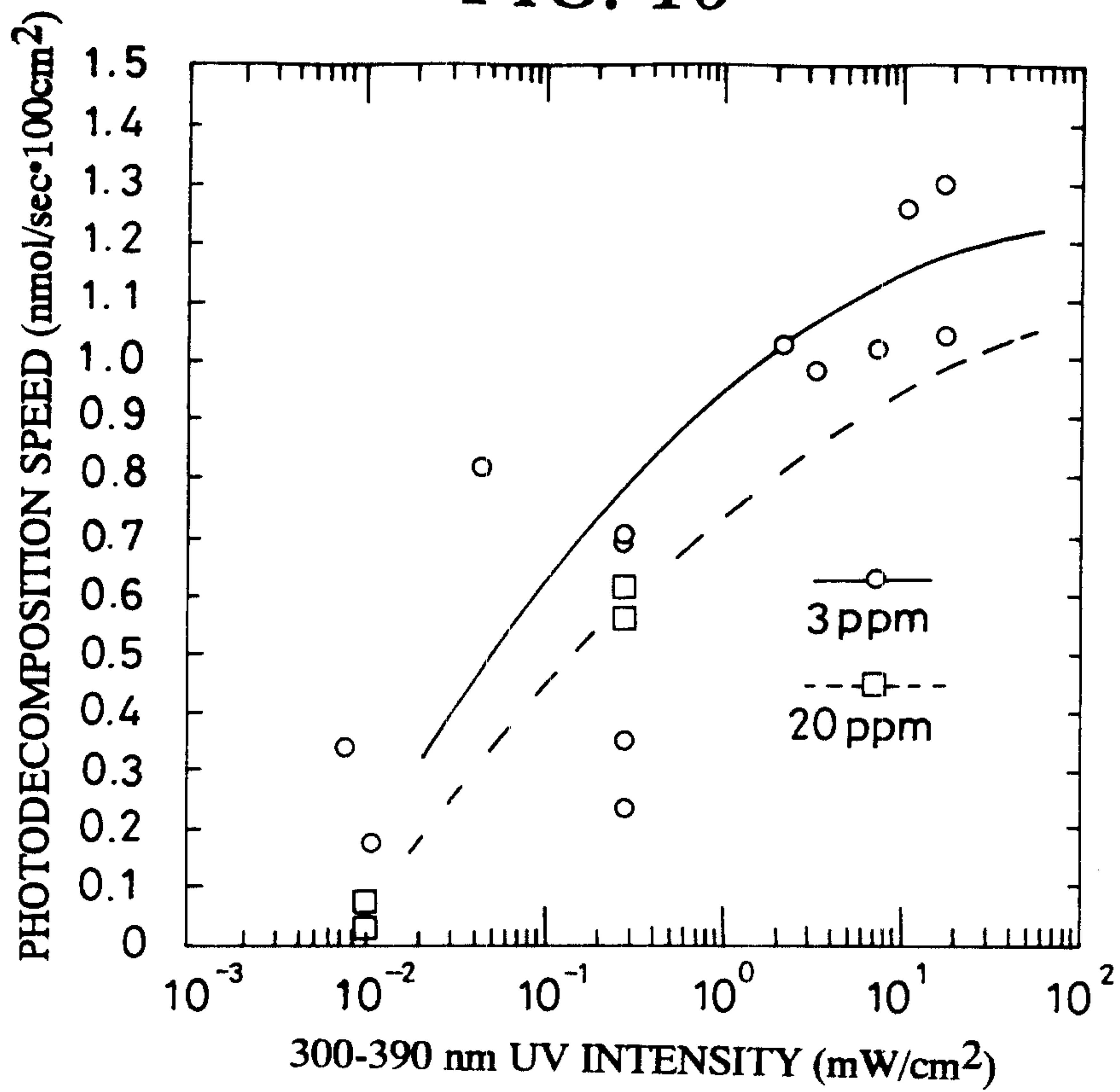

FIG. 11

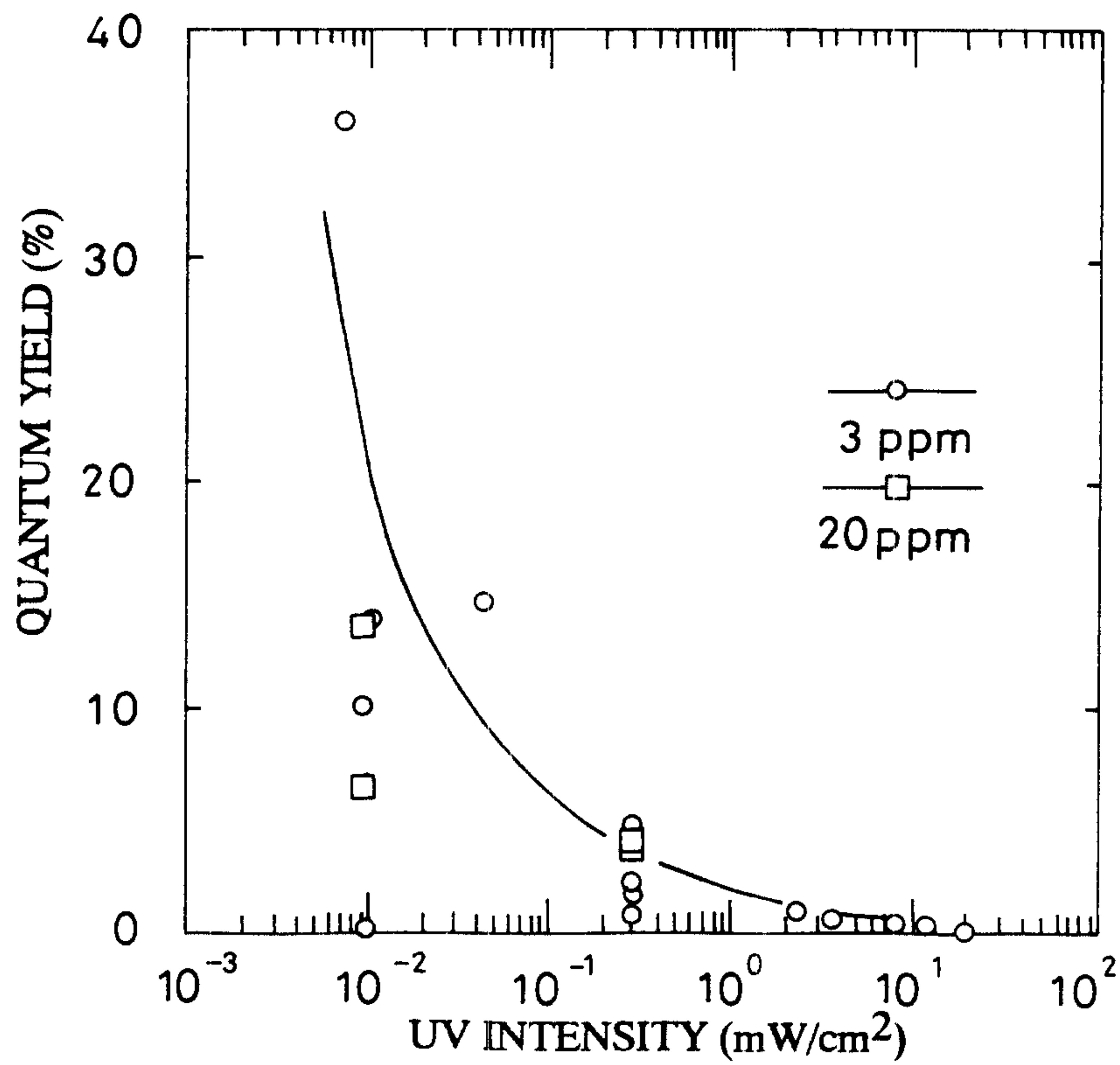

FIG. 12

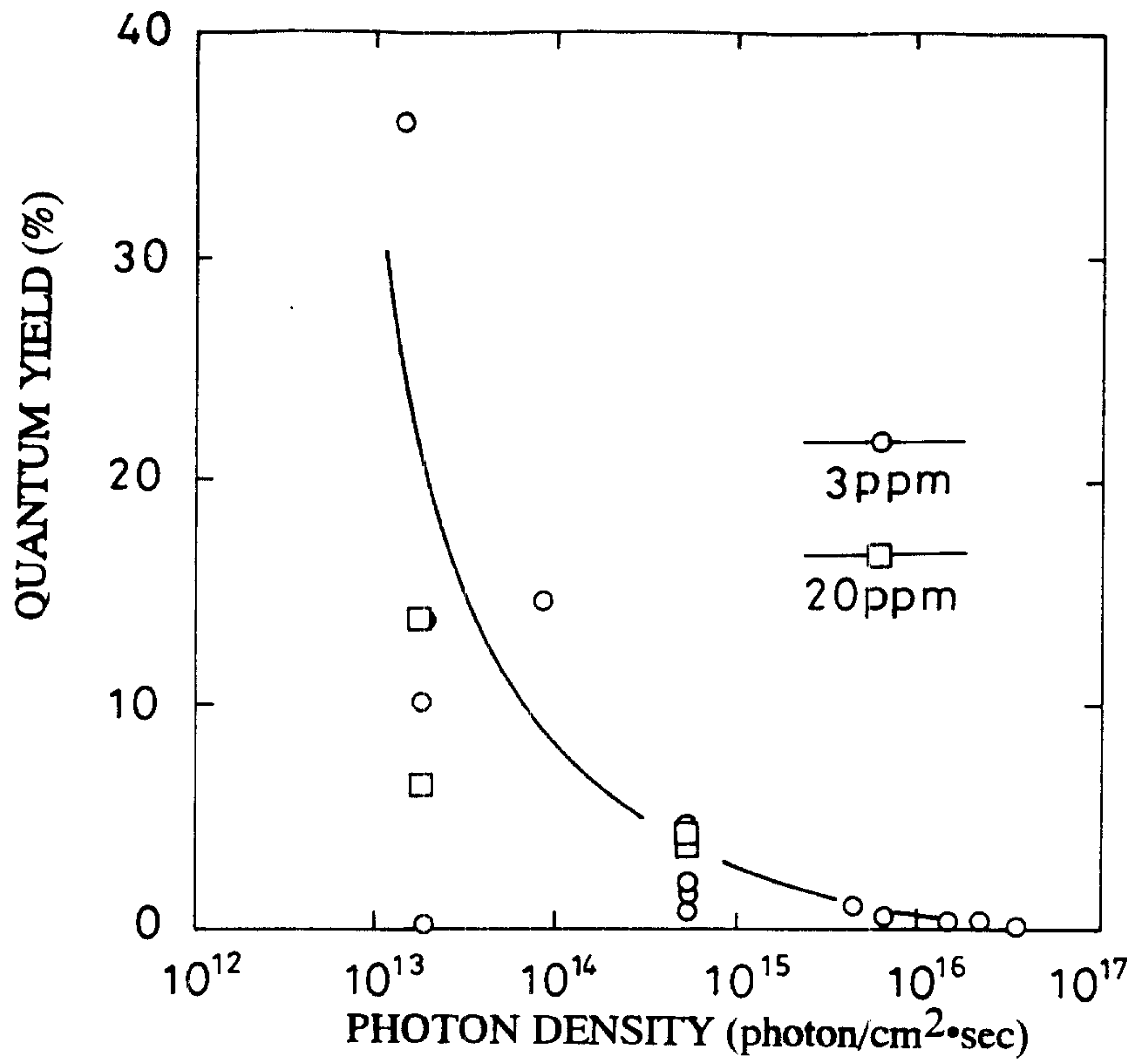

FIG. 13

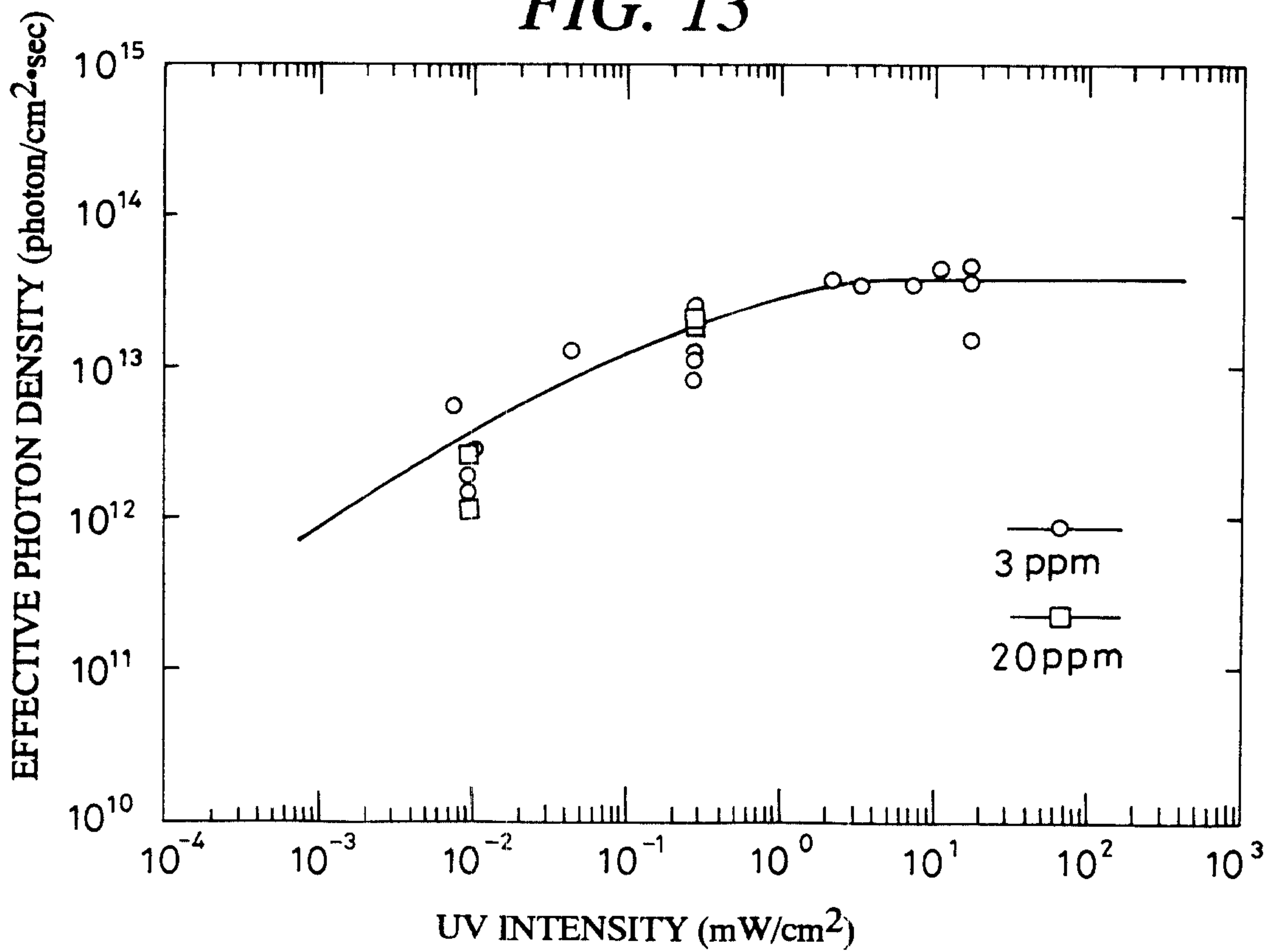

FIG. 14

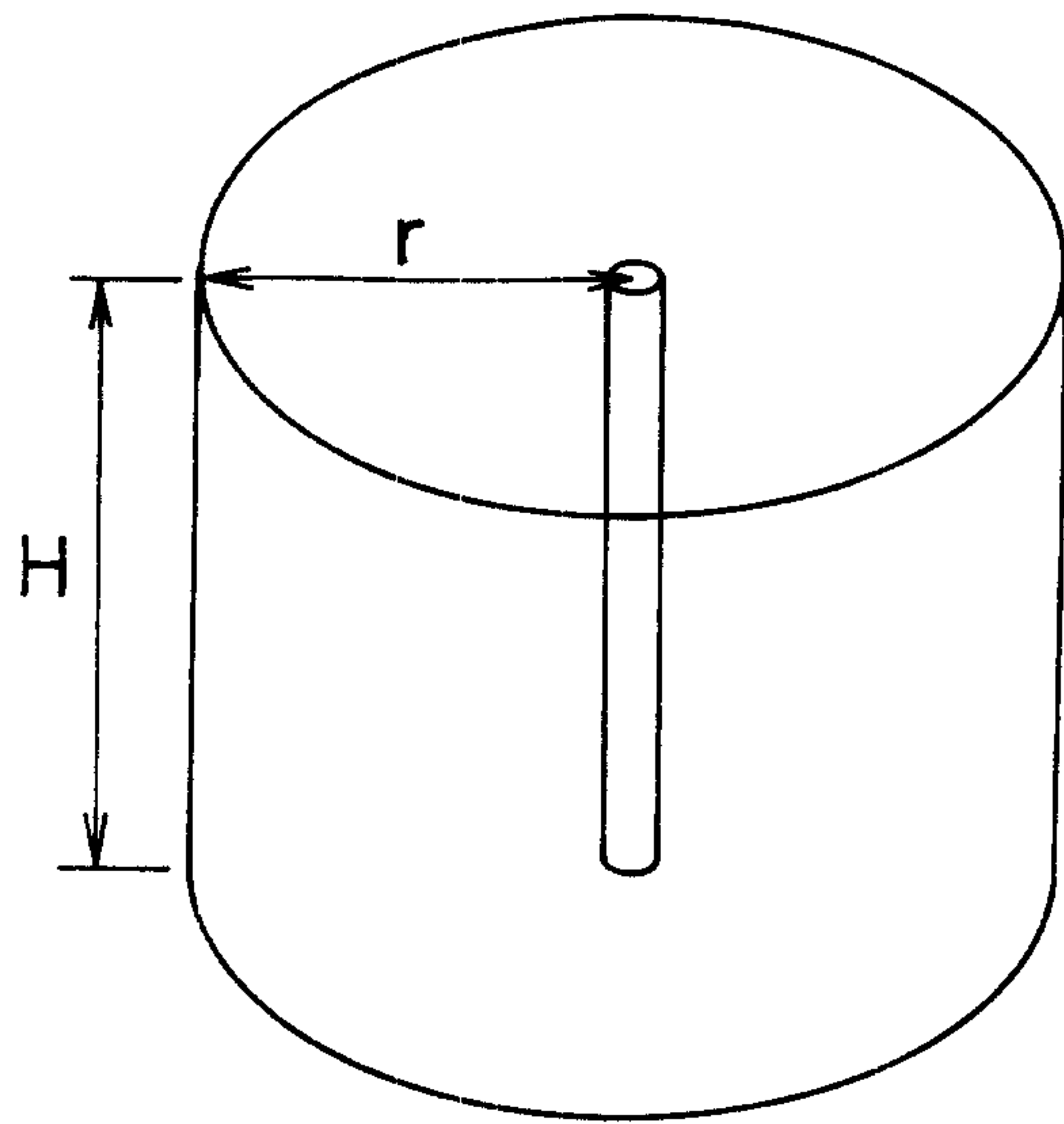

FIG. 15

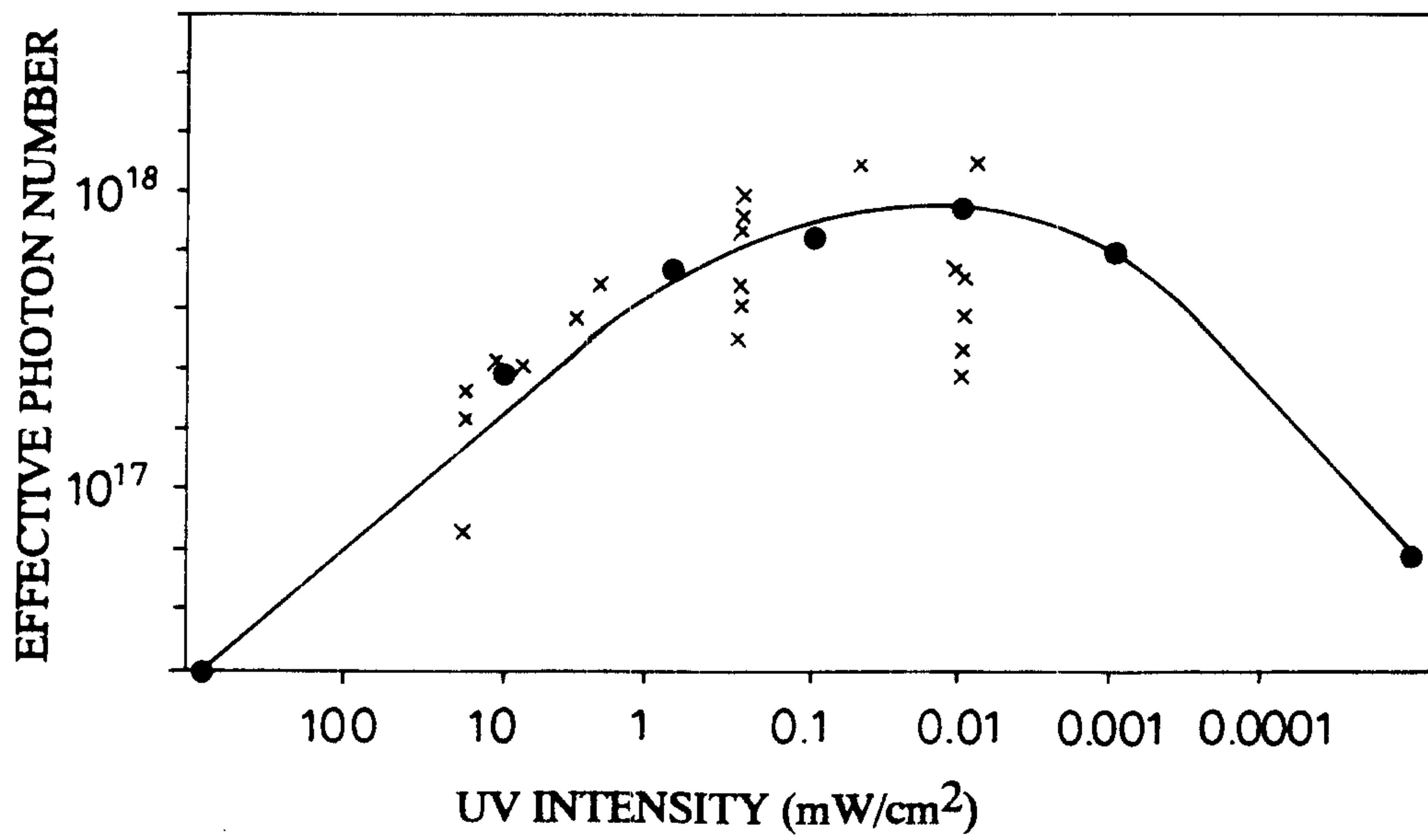

FIG. 16

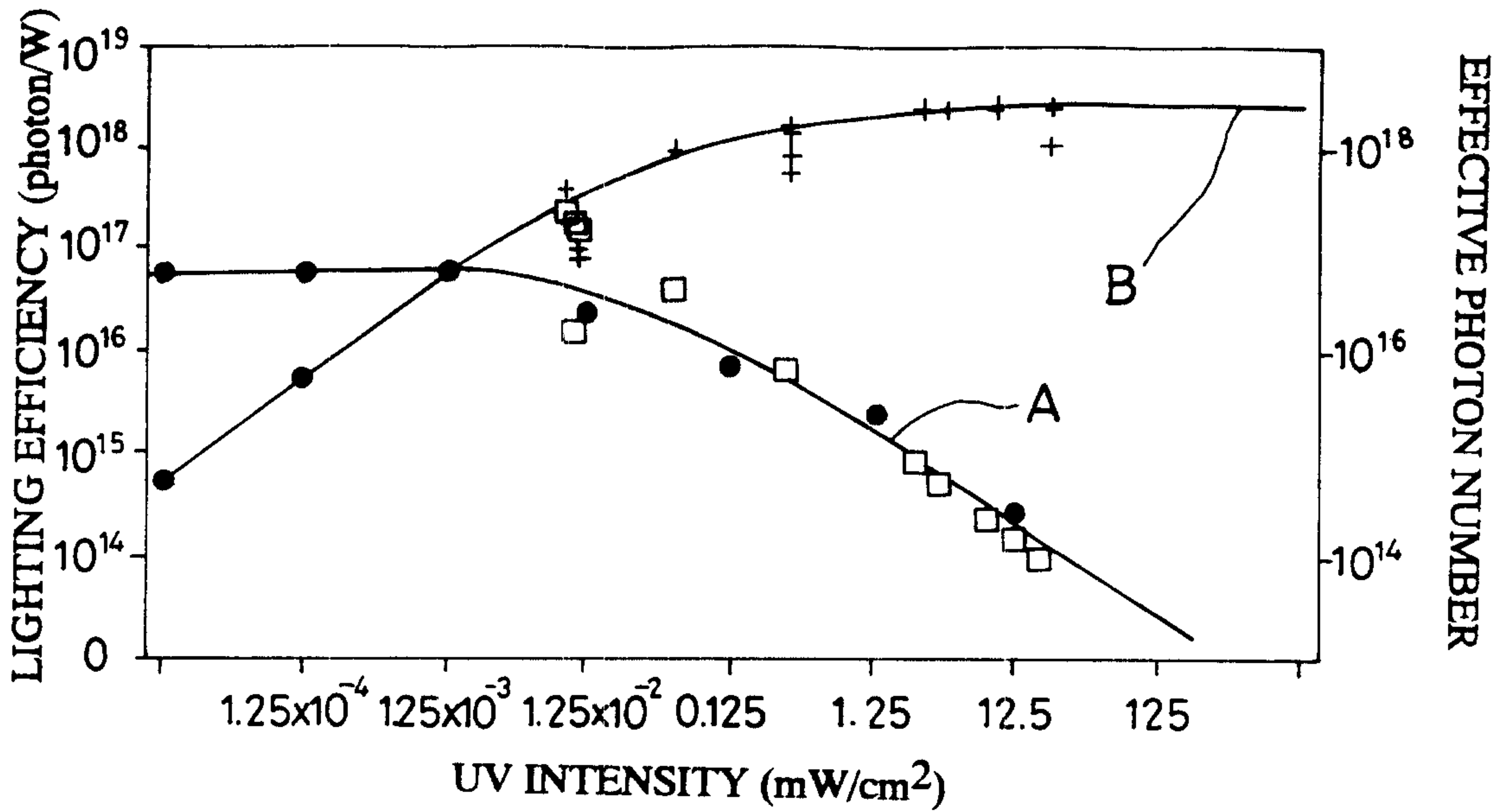

FIG. 17

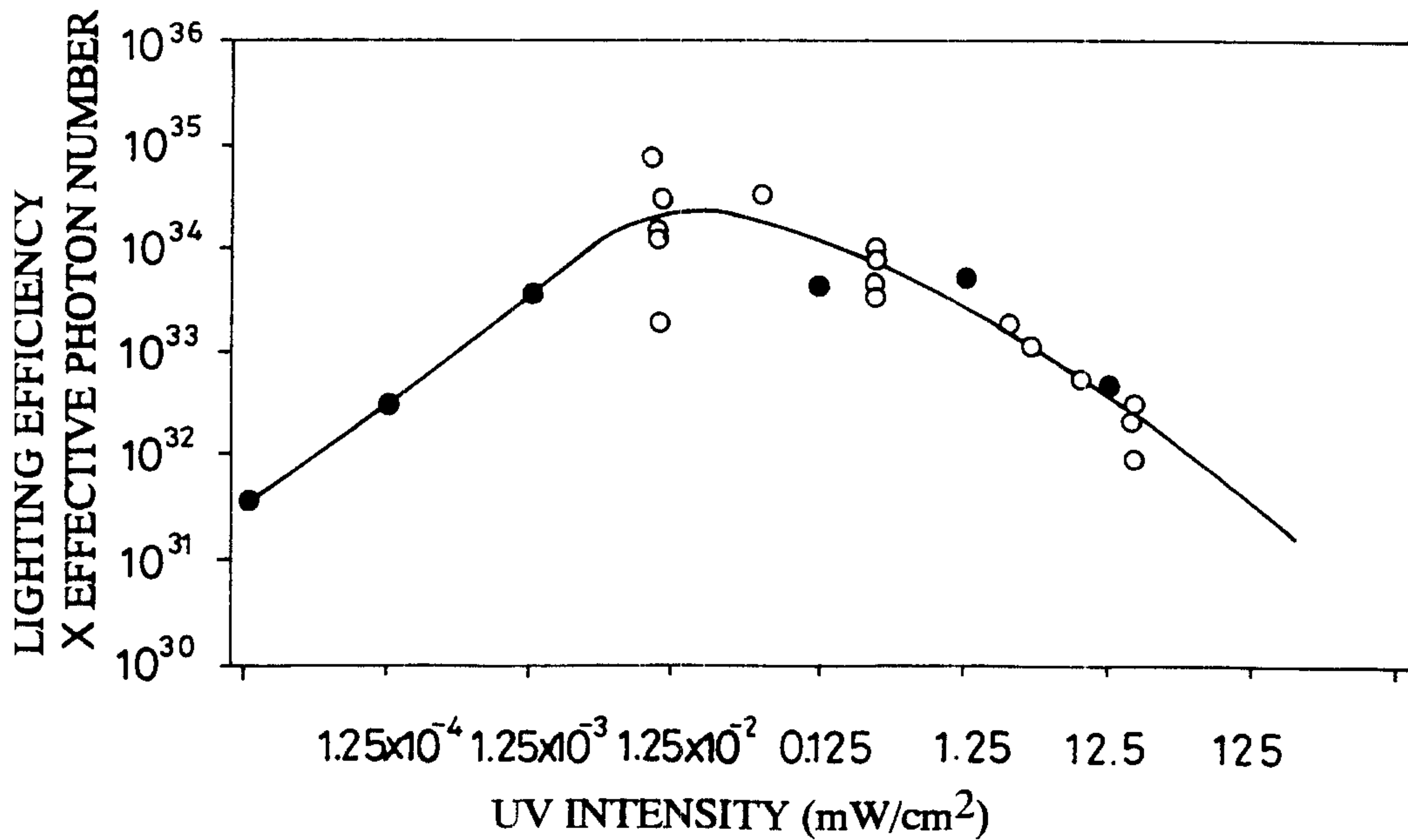

FIG. 18

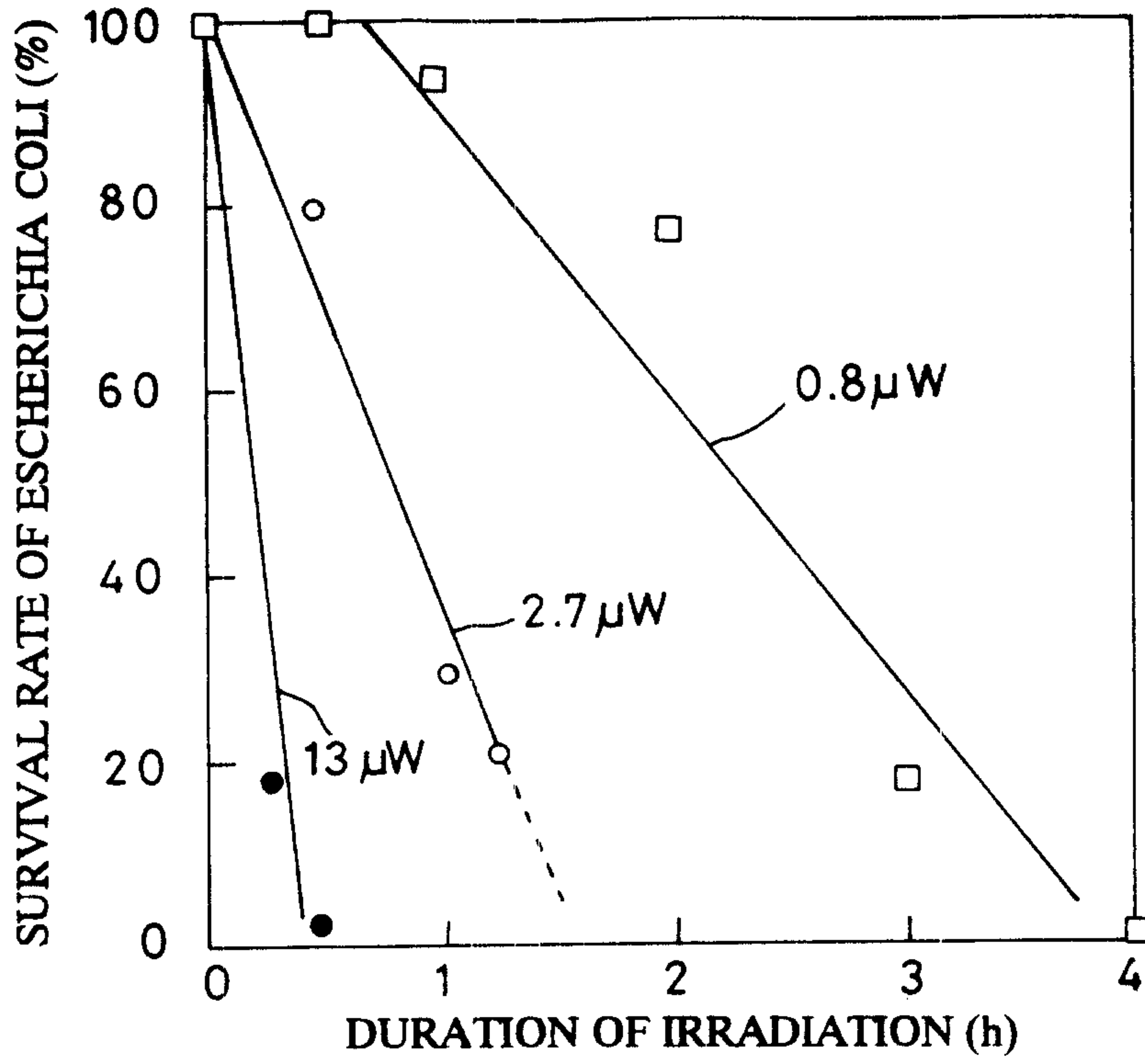

FIG. 19

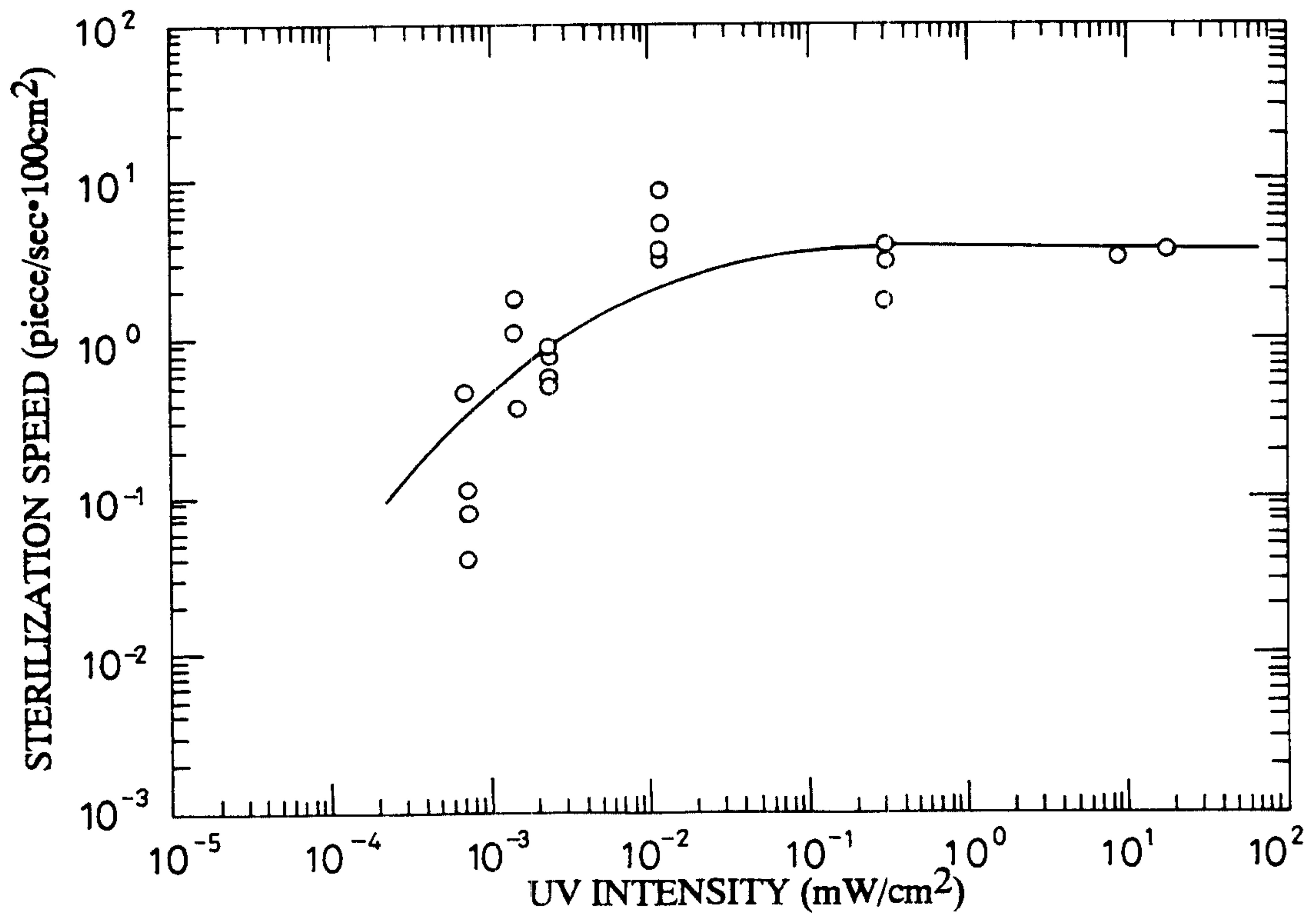

FIG. 20

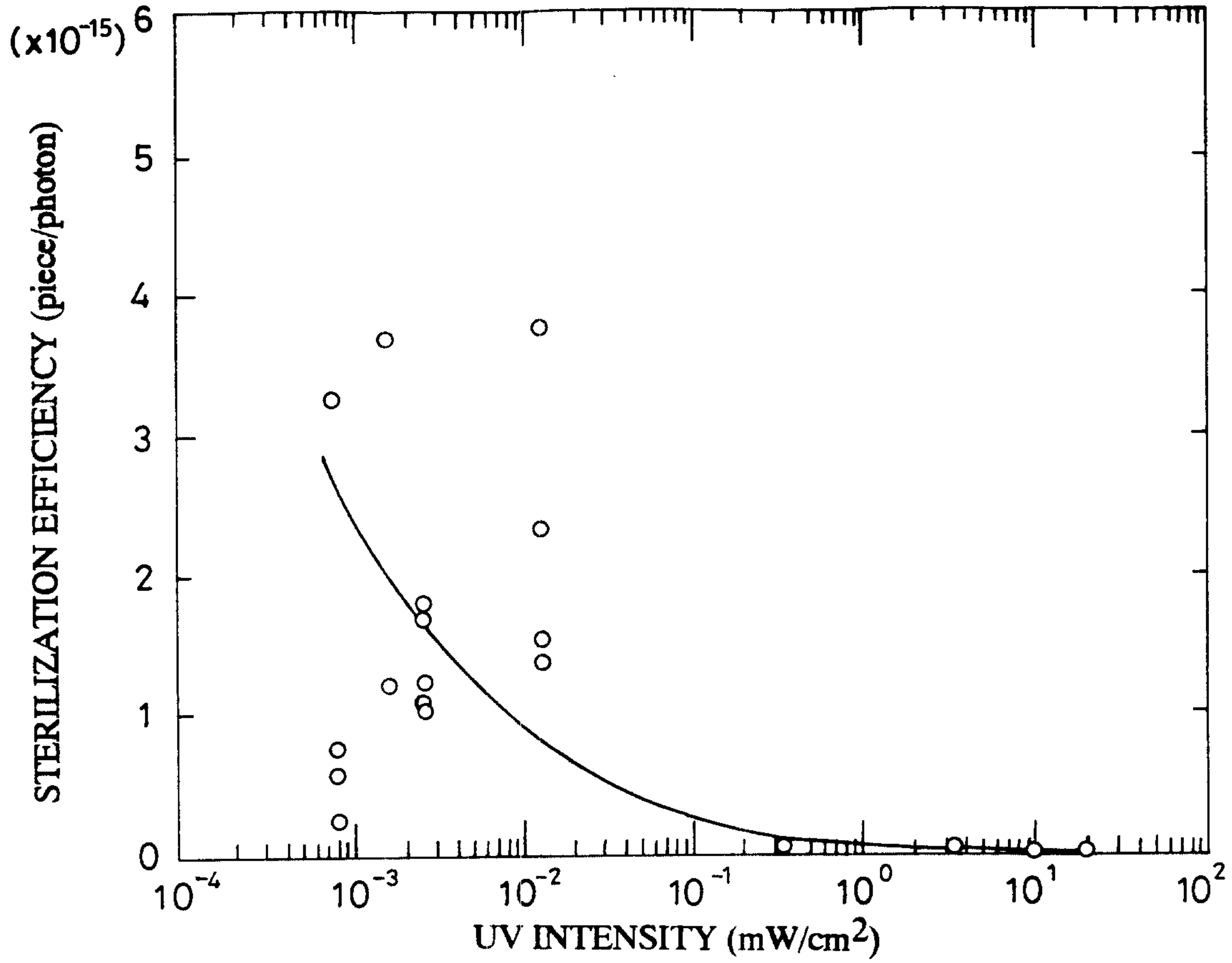
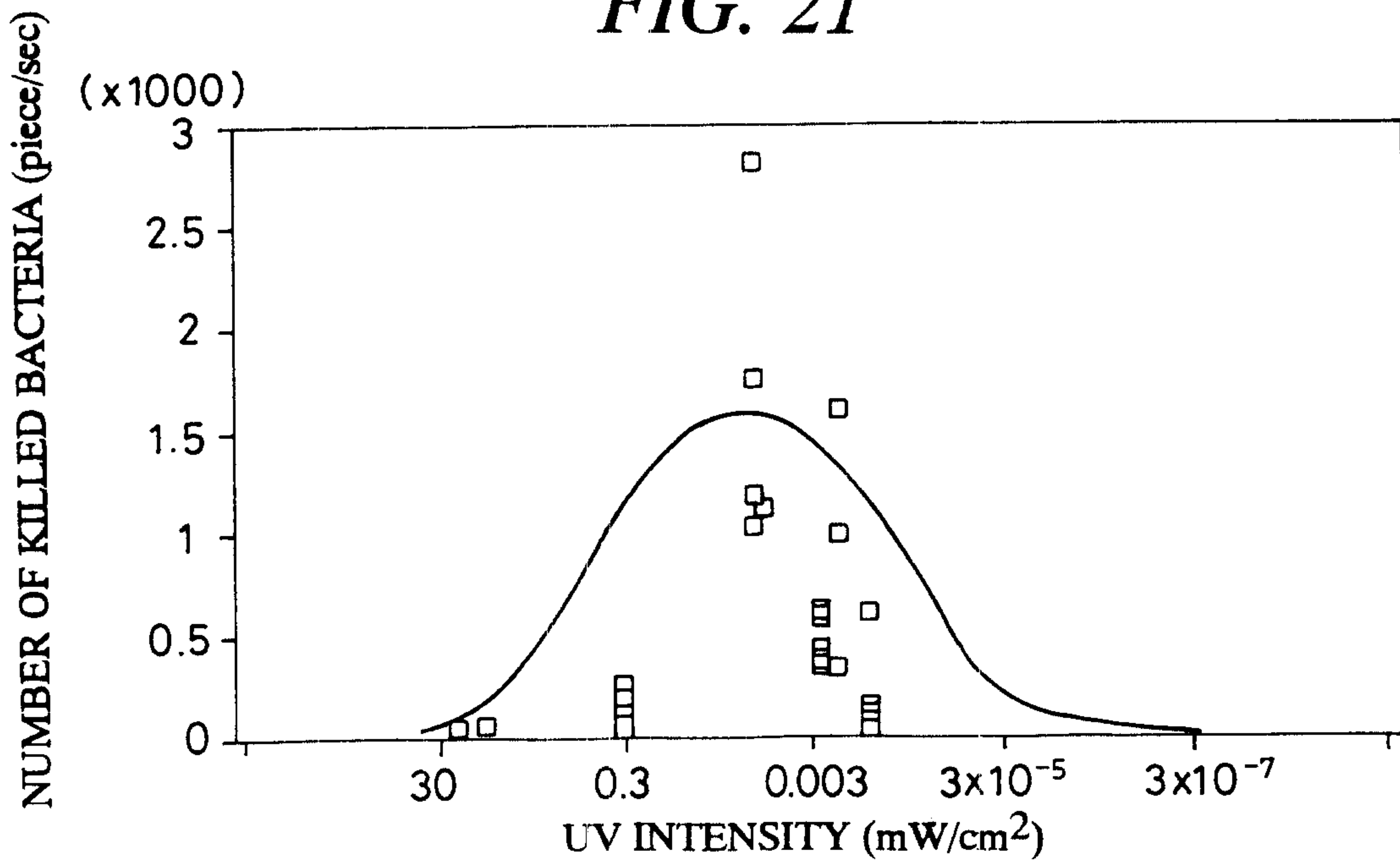
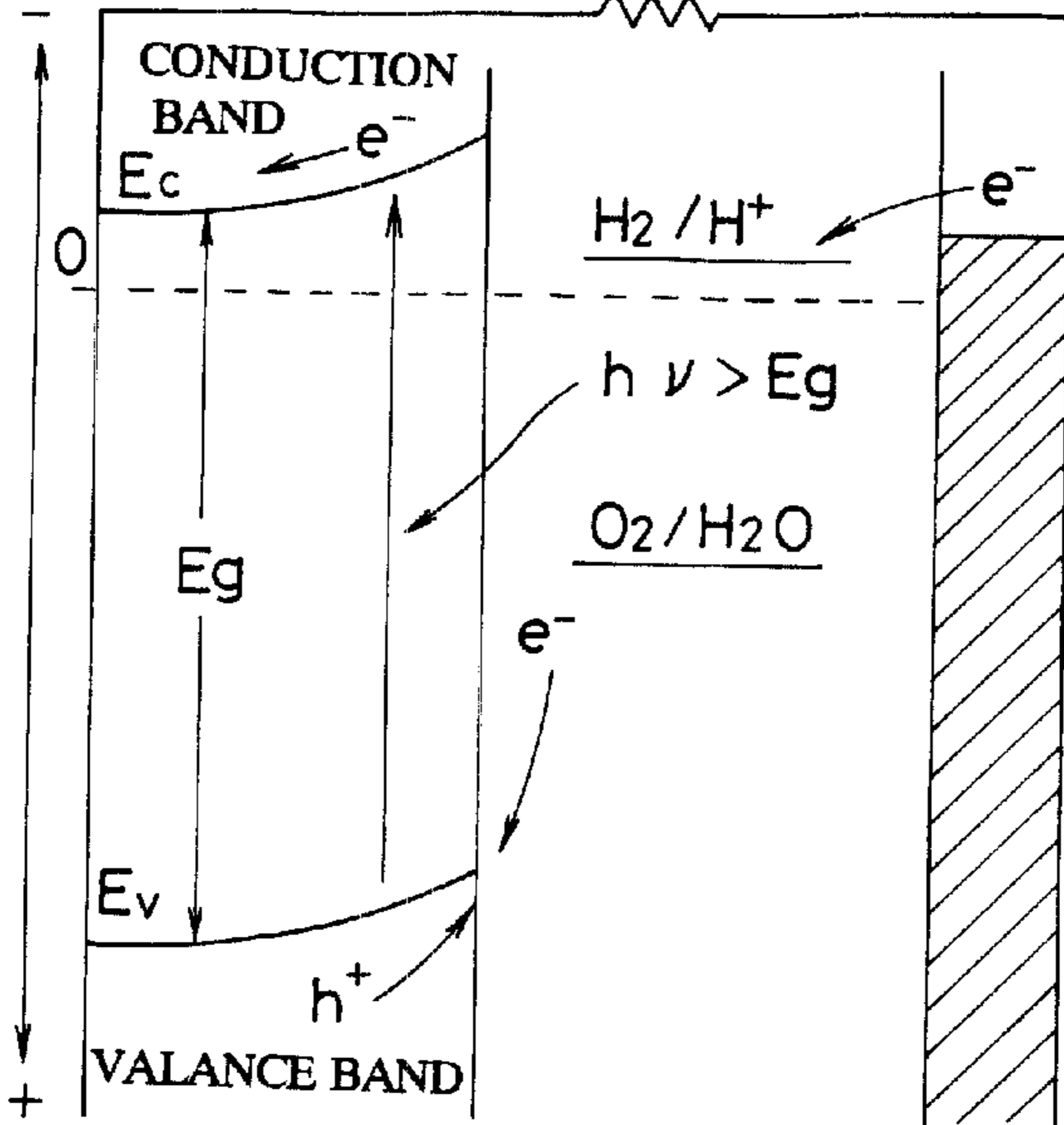

FIG. 21



LEAD WIRE e^- \rightarrow

V vs N.H.E.



ELECTROLYTE

n-TYPE SEMICONDUCTOR

METALLIC
COUNTER ELECTRODE