



US00D668239S

(12) **United States Design Patent**
Marsh

(10) **Patent No.:** **US D668,239 S**

(45) **Date of Patent:** **** Oct. 2, 2012**

(54) **COMMUNICATIONS EQUIPMENT**

(75) Inventor: **Geoff Marsh**, Farnham (GB)

(73) Assignee: **British Telecommunications Public Limited Company**, London (GB)

(**) Term: **14 Years**

(21) Appl. No.: **29/406,427**

(22) Filed: **Nov. 14, 2011**

(30) **Foreign Application Priority Data**

May 12, 2011 (GB) 4019986

(51) **LOC (9) Cl.** **14-03**

(52) **U.S. Cl.** **D14/159**

(58) **Field of Classification Search** D14/167,
D14/154, 168, 188, 496, 156, 160, 161, 162,
D14/163, 164, 165, 158, 253, 192, 159, 155,
D14/138 AB, 137, 104.1; 455/351, 350,
455/353; D10/104, 106, 65, 78; 340/573.4,
340/573.1

See application file for complete search history.

(56) **References Cited**

U.S. PATENT DOCUMENTS

- D376,764 S * 12/1996 Barnes D10/104.1
- D377,457 S * 1/1997 Arney et al. D14/159
- D394,652 S * 5/1998 Greger D14/137
- D398,303 S * 9/1998 Greger D14/137
- D413,827 S * 9/1999 Fenner D10/104.1
- D428,866 S * 8/2000 You D14/137
- D480,694 S * 10/2003 Heath D14/137
- D487,898 S * 3/2004 Cobigo D14/496
- D497,149 S * 10/2004 Daniels D14/137
- D516,545 S * 3/2006 Lai D14/218

- D539,252 S * 3/2007 Heath D14/137
- D584,710 S * 1/2009 Bishop et al. D14/138 R
- 7,697,891 B2 * 4/2010 Desrosiers et al. 455/39
- 2003/0122676 A1 * 7/2003 Cuijpers et al. 340/573.1

FOREIGN PATENT DOCUMENTS

GB 4022264 1/2012

* cited by examiner

Primary Examiner — Austin Murphy

(74) *Attorney, Agent, or Firm* — Patterson Thuent
Christensen Pedersen, P.A.

(57) **CLAIM**

I claim the ornamental design for communications equip-
ment, as shown and described.

DESCRIPTION

FIG. 1 is a front perspective view of communications equip-
ment according to an embodiment of the invention.

FIG. 2 is a back perspective view of the communications
equipment depicted in FIG. 1.

FIG. 3 is a front elevation view of the communications equip-
ment depicted in FIG. 1.

FIG. 4 is a top plan view of the communications equipment
depicted in FIG. 1.

FIG. 5 is a right side elevation view of the communications
equipment depicted in FIG. 1.

FIG. 6 is a left side elevation view of the communications
equipment depicted in FIG. 1.

FIG. 7 is a back elevation view of the communications equip-
ment depicted in FIG. 1; and,

FIG. 8 is a bottom plan view of the communications equip-
ment depicted in FIG. 1.

1 Claim, 4 Drawing Sheets

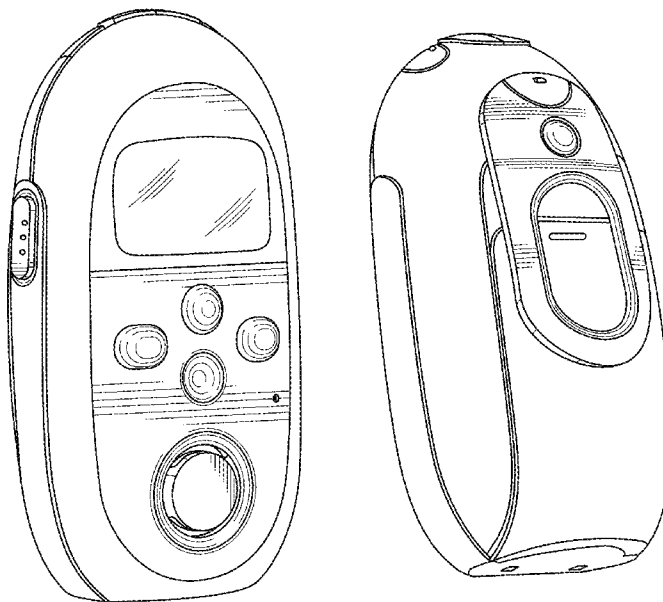

Fig. 1

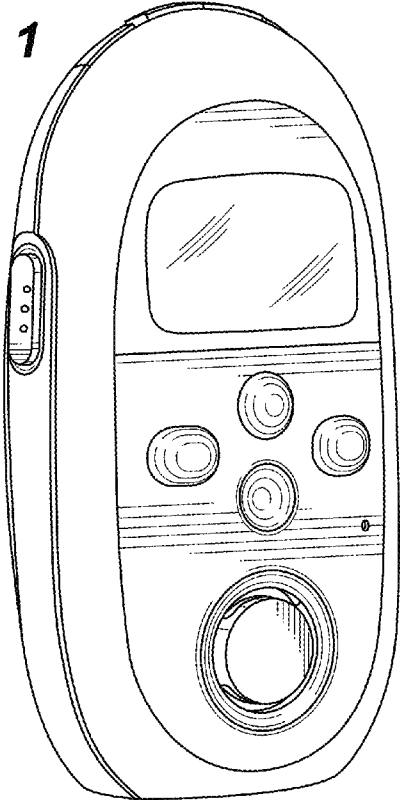

Fig. 2

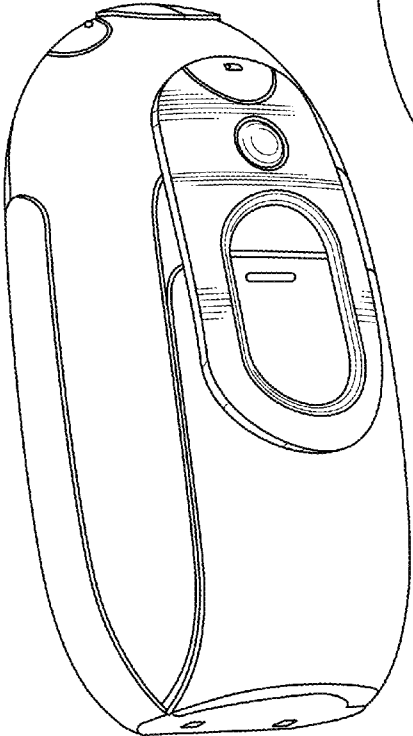

Fig. 3

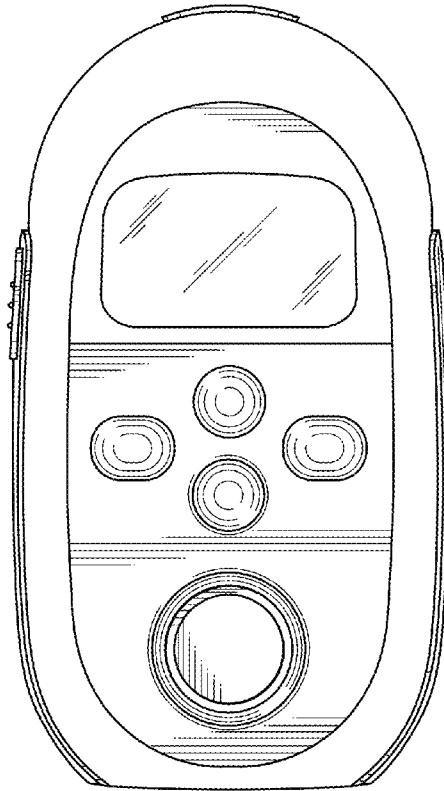

Fig. 4

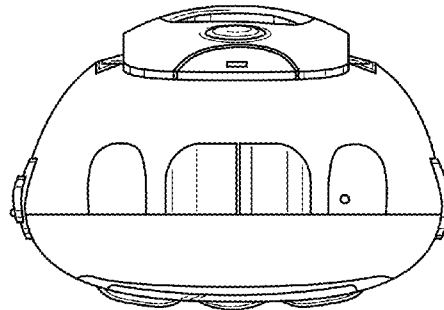

Fig. 5

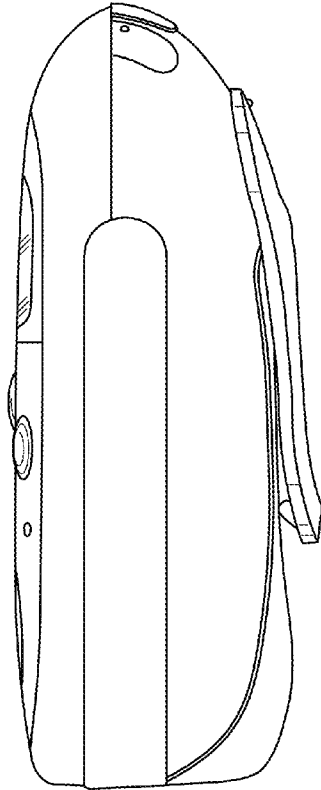

Fig. 6

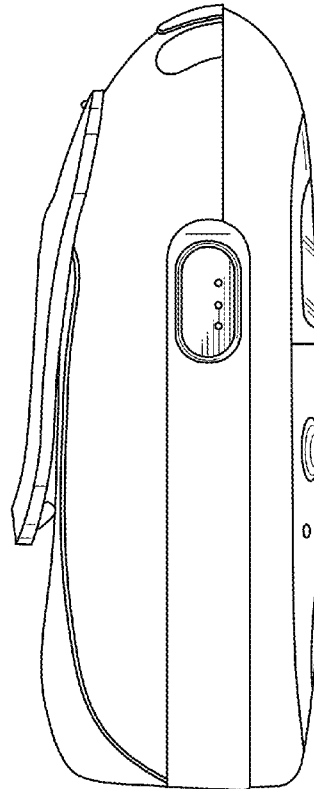

Fig. 7

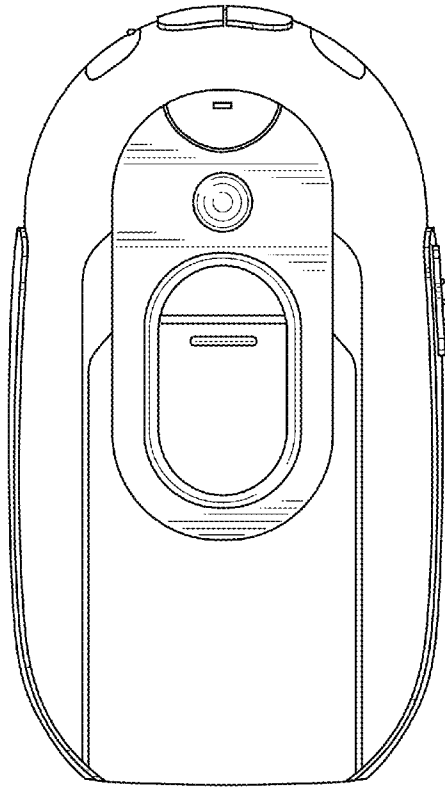

Fig. 8

