



US00D347285S

United States Patent [19]

[11] Patent Number: Des. 347,285

Woolbright

[45] Date of Patent: ** May 24, 1994

[54] **RETAINING WALL BUILDING BLOCK**

[75] Inventor: **Mark A. Woolbright**, St. Louis, Mo.

[73] Assignee: **St. Louis Retaining Wall Co., Inc.**, St. Louis, Mo.

[**] Term: **14 Years**

[21] Appl. No.: **900,853**

[22] Filed: **Jun. 18, 1992**

[52] U.S. Cl. **D25/113**

[58] Field of Search 52/596, 598, 603; 405/284; D25/112-116

[56] **References Cited**

U.S. PATENT DOCUMENTS

D. 217,244	4/1970	Fairfield	D25/1
D. 296,007	5/1988	Forsberg	D25/116
D. 296,365	6/1988	Forsberg	D25/116
D. 300,253	3/1989	Forsberg	D25/114
D. 300,254	3/1989	Forsberg	D25/114
D. 310,267	8/1990	Zeidman	D25/112
D. 319,885	9/1991	Blomquist et al.	D25/113
1,015,584	1/1912	Powell	.	
1,349,552	8/1920	Baumann	.	
2,313,363	3/1943	Schmitt	D25/113
3,073,061	1/1963	Pearson	47/34
3,389,499	6/1968	Haile	47/33
4,060,952	12/1977	Hernandez	52/593
4,107,894	8/1978	Mullins	52/593
4,229,123	10/1980	Heinzmann	405/273
4,379,659	4/1983	Steiner	405/284
4,426,176	1/1984	Terada	405/285
4,521,138	6/1985	Steiner	405/284
4,565,043	1/1986	Mazzarese	52/593
4,671,706	6/1987	Giardini	405/286
4,684,294	8/1987	O'Neill	405/286
4,914,876	4/1990	Forsberg	52/169
4,920,712	5/1990	Dean, Jr.	52/169
4,930,283	6/1990	Winkler	52/611
4,982,544	1/1991	Smith	52/603
5,017,049	5/1991	Sievert	52/596
5,044,834	9/1991	Janopaul, Jr.	405/284

5,066,169	11/1991	Gavin et al.	405/284
5,072,566	12/1991	Zeidman	52/608
5,108,231	4/1992	Rausch	D25/113
5,177,925	1/1993	Winkler et al.	405/284

FOREIGN PATENT DOCUMENTS

2651258 3/1991 France .

OTHER PUBLICATIONS

Seagren Industries, Inc., St. Louis, Mo., Loffelstein Retaining Walls, pp. 1-4 and insert, Circa. 1990.
 Kiltie Corporation, North St. Paul., Minn., Versa-Lok Retaining Wall Systems, Foldable insert, 1989.
 Keystone Retaining Wall Systems, Inc., Minneapolis, Minn., Compac Unit, pp. 1 and 2, 1990.
 Keystone Retaining Wall Systems, Inc., Minneapolis, Minn., Keystone Retaining Wall Systems, Foldable insert, 1991.
 Allan Block Corporation, Bloomington, Minn., Allan Block Retaining Walls, pp. 1-4 and two inserts, 1990.
 Stone Wall, Landscape Retaining Wall System, pp. 1-4 and one insert, Circa. 1990.

Primary Examiner—A. Hugo Word

Assistant Examiner—Doris Clark

Attorney, Agent, or Firm—Senniger, Powers, Leavitt & Roedel

[57] **CLAIM**

The ornamental design for retaining wall building block, as shown and described.

DESCRIPTION

FIG. 1 is a top plan view of a retaining wall building block of a first embodiment showing my new design; FIG. 2 is a right side elevational view thereof; FIG. 3 is a left side elevational view thereof; FIG. 4 is a front view thereof; FIG. 5 is a rear elevational view thereof; FIG. 6 is a bottom plan view thereof; and, FIG. 7 is a front view of a retaining wall building block of a second embodiment.

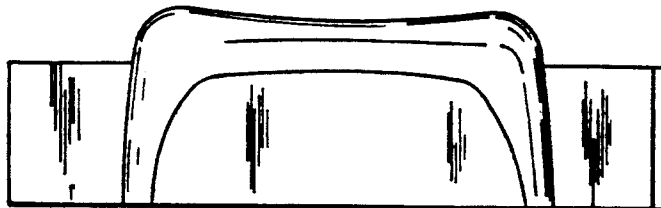

FIG. 1

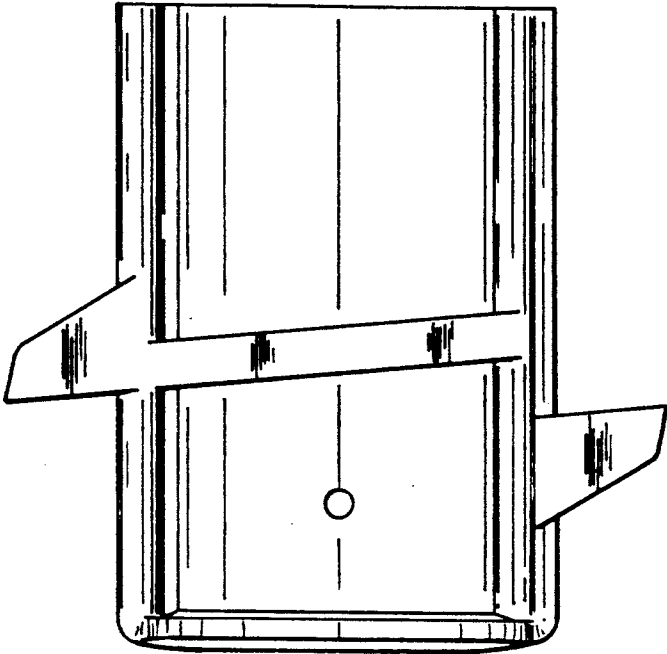

FIG. 2

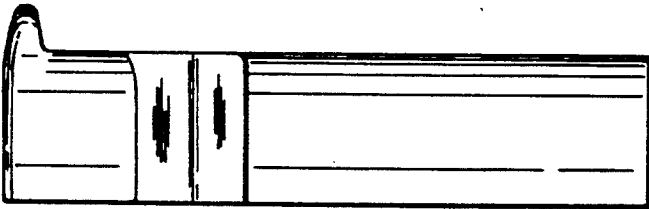

FIG. 3

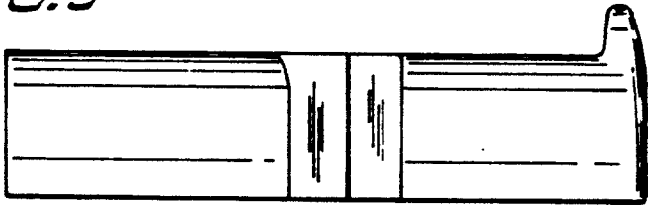

FIG. 4

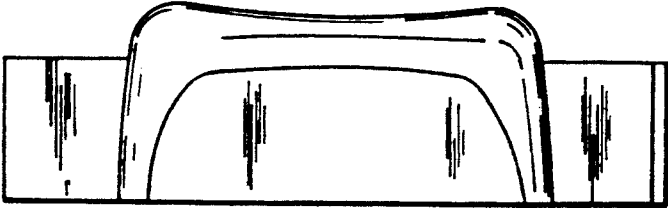

FIG. 5

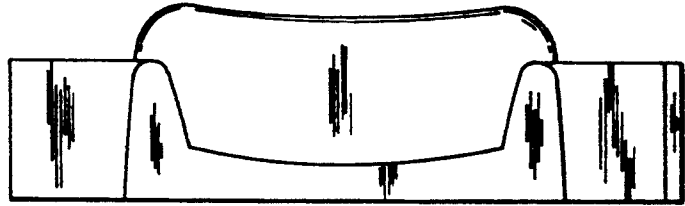

FIG. 6

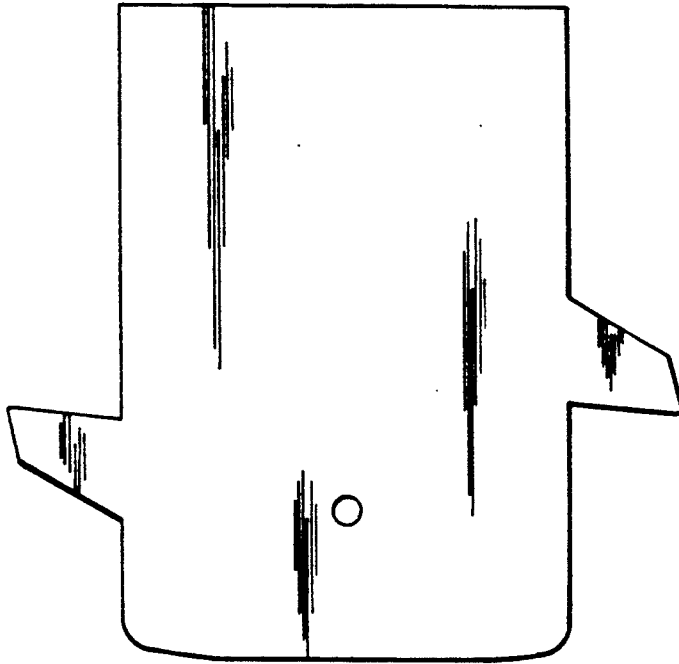

FIG. 7

