



US00D804029S

(12) **United States Design Patent**
Blocher

(10) **Patent No.:** **US D804,029 S**

(45) **Date of Patent:** **** Nov. 28, 2017**

- (54) **SCISSOR**
- (71) Applicant: **KARL STORZ GmbH & Co. KG**,
Tuttlingen (DE)
- (72) Inventor: **Martin Blocher**, Stockach (DE)
- (73) Assignee: **KARL STORZ GmbH & Co. KG**,
Tuttlingen (DE)
- (**) Term: **15 Years**
- (21) Appl. No.: **29/533,366**
- (22) Filed: **Jul. 16, 2015**
- (30) **Foreign Application Priority Data**

Jan. 16, 2015 (EM) 002615203-0001

- (51) **LOC (10) Cl.** **24-02**
- (52) **U.S. Cl.**
USPC **D24/148**
- (58) **Field of Classification Search**
USPC D24/133, 135, 146, 148, 147, 143, 138
CPC A61B 2018/00607; A61B 2018/00601;
A61B 17/34; A61B 17/32; A61B 17/16
See application file for complete search history.

(56) **References Cited**

U.S. PATENT DOCUMENTS

D274,096	S	*	5/1984	Shutt	D24/143
D289,437	S	*	4/1987	Honkanen	D24/148
4,896,678	A	*	1/1990	Ogawa	A61B 17/29 600/564
D307,322	S	*	4/1990	Dolwick	D24/135
5,304,203	A	*	4/1994	El-Mallawany	A61B 17/29 600/564
D350,606	S	*	9/1994	Koros	D24/143
5,474,571	A	*	12/1995	Lang	A61B 17/29 606/174

5,951,465	A	*	9/1999	Schiff	A61B 17/4241 600/224
6,139,563	A	*	10/2000	Cosgrove, III	A61B 17/122 600/564
6,626,929	B1	*	9/2003	Bannerman	A61B 17/2909 606/205
D498,300	S	*	11/2004	Karl-Heinz	D24/146
D535,398	S	*	1/2007	Stammberger	D24/133
D548,836	S	*	8/2007	Lang	D24/146
D605,761	S	*	12/2009	Stefan	D24/133
D612,494	S	*	3/2010	Ott	D24/135
D617,456	S	*	6/2010	Ott	D24/135
D630,322	S	*	1/2011	Speiser	D24/133
D641,872	S	*	7/2011	Solingen	D24/133
D641,873	S	*	7/2011	Solingen	D24/133
D669,177	S	*	10/2012	Castelnuovo	D24/143
D669,178	S	*	10/2012	Castelnuovo	D24/143
D698,920	S	*	2/2014	Strobel	D24/133
D753,299	S	*	4/2016	Di Spiezio Sardo	D24/143

(Continued)

Primary Examiner — Lakiya Rogers

Assistant Examiner — Carissa C Fitts

(74) *Attorney, Agent, or Firm* — Muncy, Geissler, Olds & Lowe, P.C.

(57) **CLAIM**

The ornamental design for a scissor, as shown and described.

DESCRIPTION

FIG. 1 is a front perspective view of a scissor according to the present invention.
 FIG. 2 is a left side view of the scissor of FIG. 1.
 FIG. 3 is a right side view of the scissor of FIG. 1.
 FIG. 4 is a top view of the scissor of FIG. 1.
 FIG. 5 is a bottom view of the scissor of FIG. 1.
 FIG. 6 is a front view of the scissor of FIG. 1; and,
 FIG. 7 is a rear view of the scissor of FIG. 1.
 The broken lines show unclaimed portions of the article and form no part of the claimed design.

1 Claim, 7 Drawing Sheets

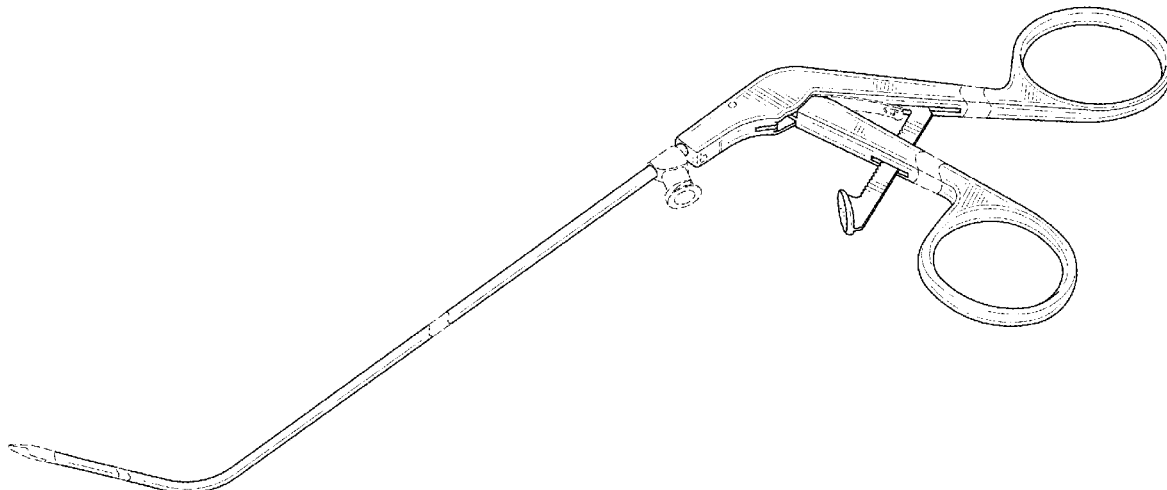

(56)

References Cited

U.S. PATENT DOCUMENTS

2004/0267304 A1* 12/2004 Zannis A61B 17/29
606/206
2005/0038469 A1* 2/2005 Lang A61B 17/29
606/207
2006/0282117 A1* 12/2006 Berberich A61B 17/0483
606/205
2008/0294192 A1* 11/2008 Stefan A61B 17/1608
606/205
2011/0046661 A1* 2/2011 Kuehn A61B 17/1608
606/206

* cited by examiner

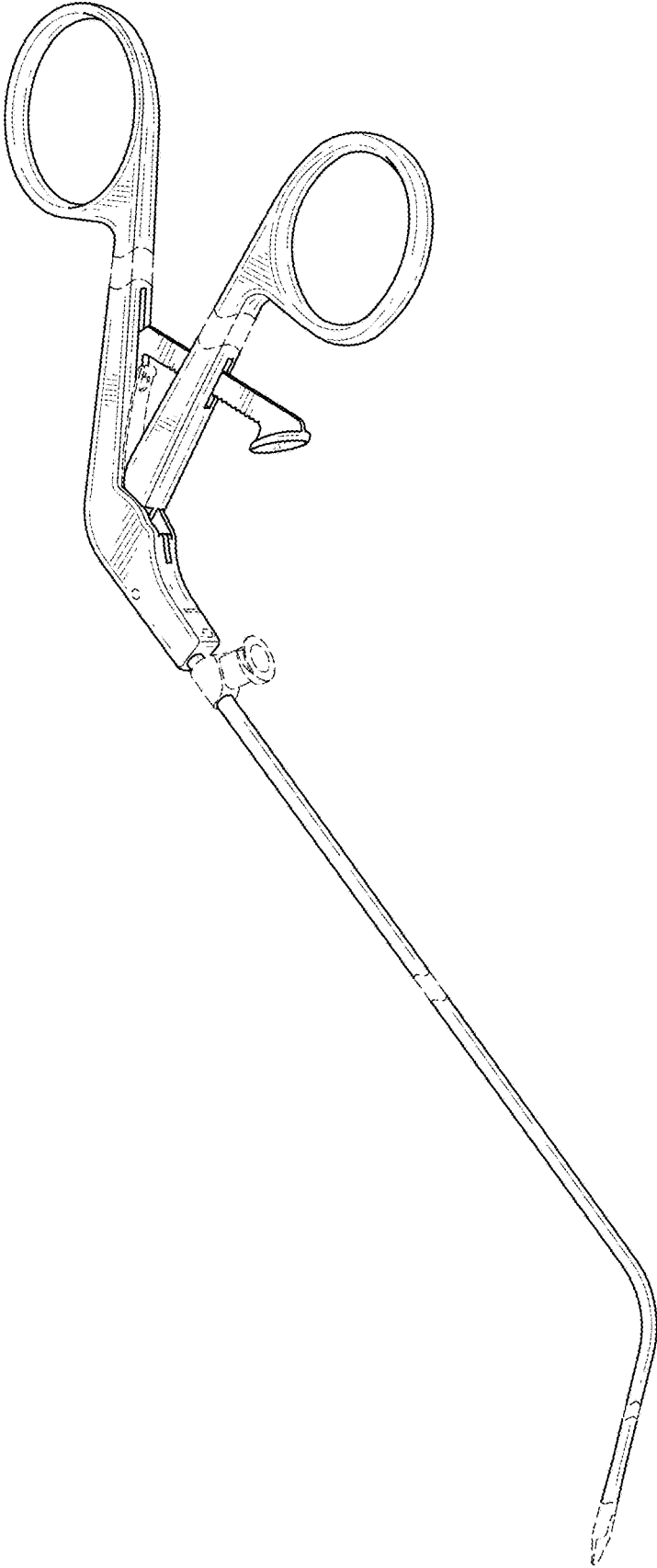

FIG.1

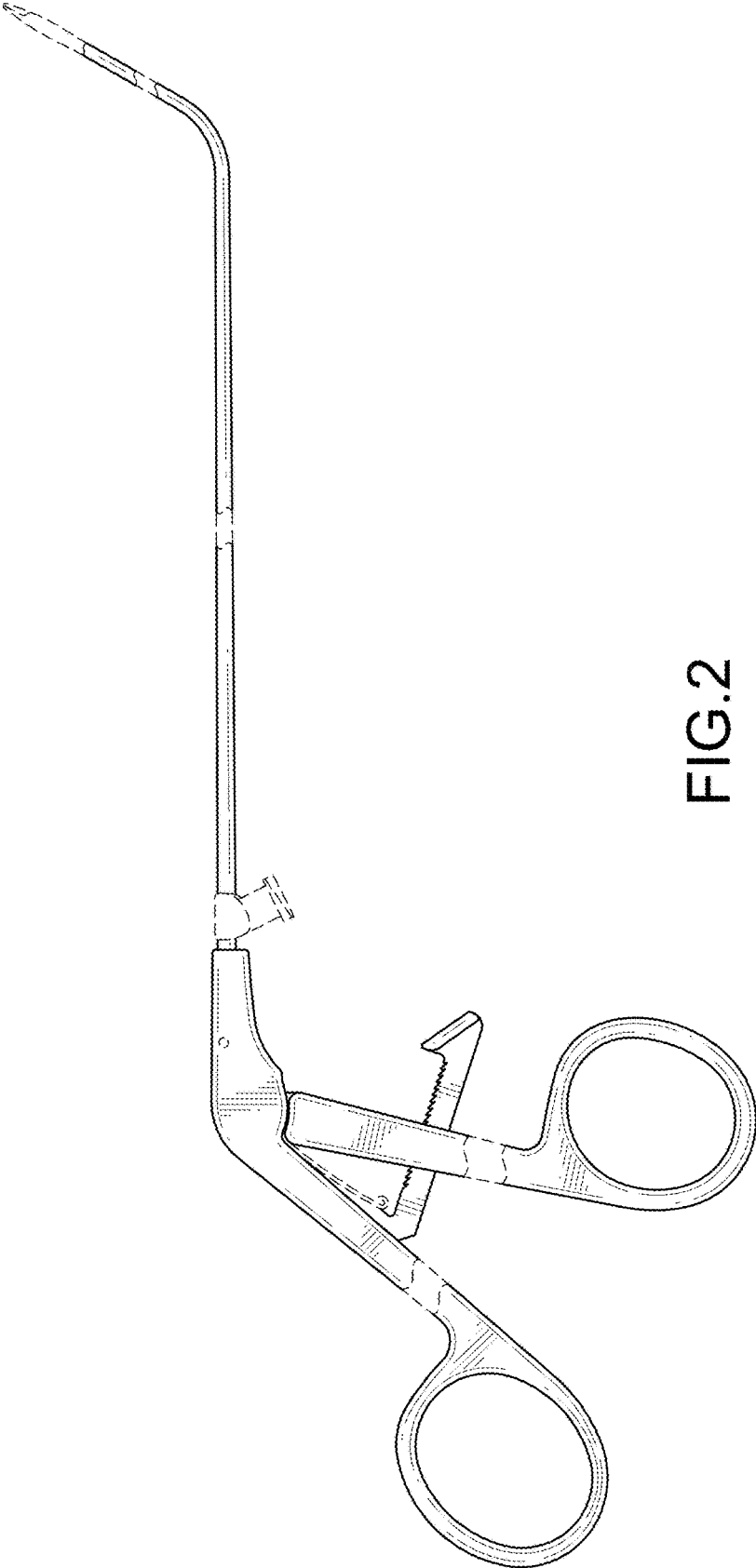

FIG. 2

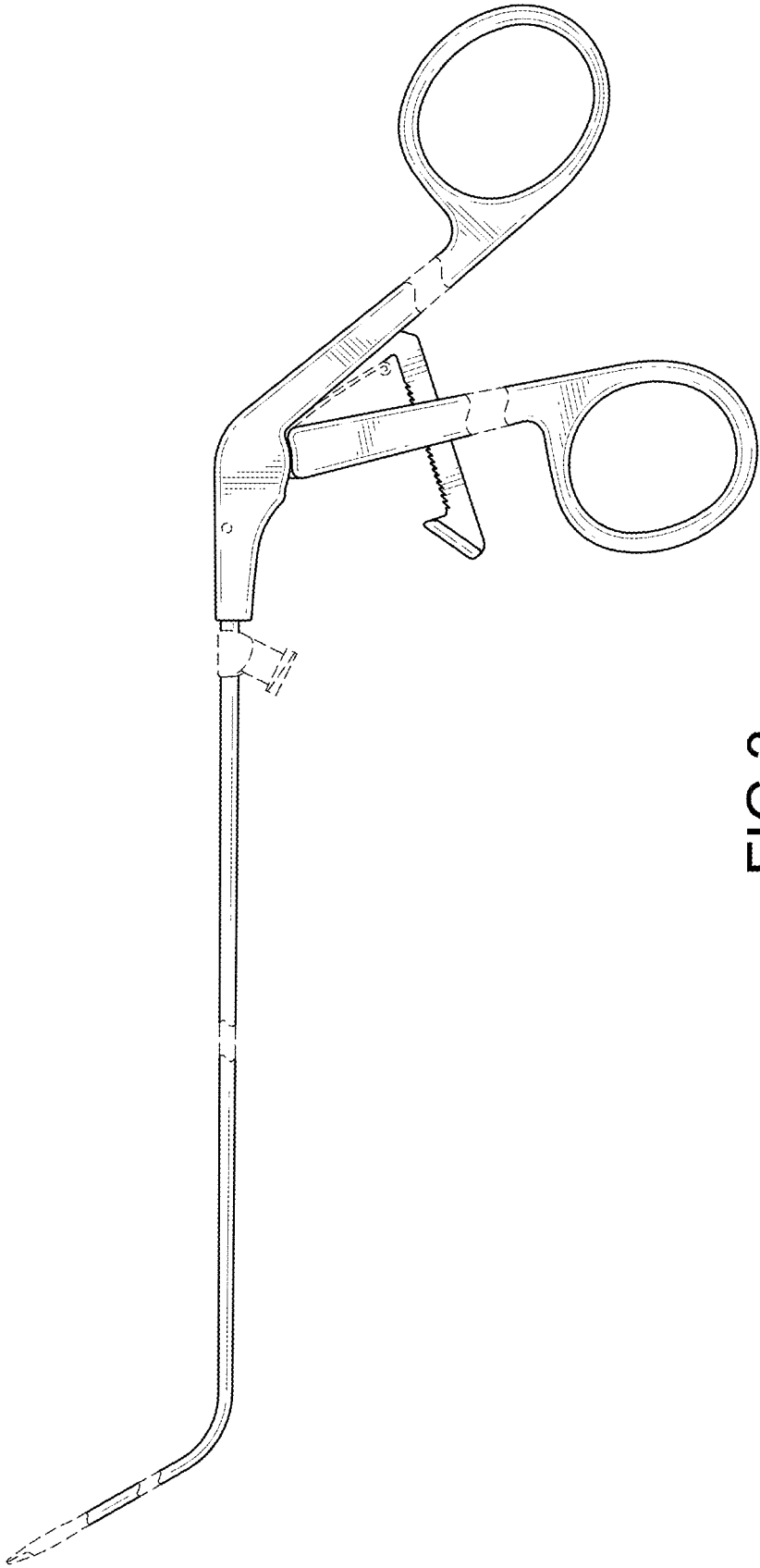

FIG.3

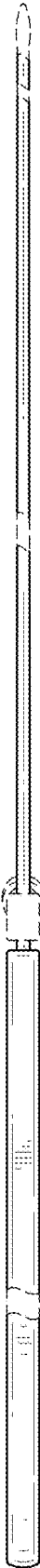

FIG.4

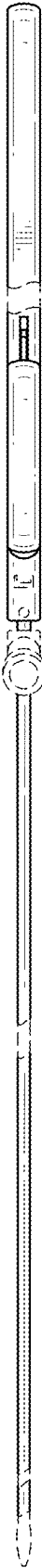

FIG.5

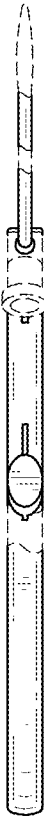

FIG.6



FIG.7