



US00D708948S

(12) **United States Design Patent**
Crawford et al.

(10) **Patent No.:** **US D708,948 S**

(45) **Date of Patent:** **** Jul. 15, 2014**

(54) **CAP FOR A CONTAINER**

(75) Inventors: **John C. Crawford**, Mahopac, NY (US);
Christopher Hart, Chicago, IL (US);
Stacy Castro, Chicago, IL (US)

(73) Assignee: **Colgate-Palmolive Company**, New York, NY (US)

(**) Term: **14 Years**

(21) Appl. No.: **29/423,999**

(22) Filed: **Jun. 7, 2012**

(51) **LOC (10) Cl.** **09-07**

(52) **U.S. Cl.**
USPC **D9/449**

(58) **Field of Classification Search**
USPC D9/435, 446, 447, 449, 454, 516, 529,
D9/530, 537-546, 550-552, 563, 565, 574,
D9/575; 215/220; 220/660, 669, 670, 675;
206/534

See application file for complete search history.

(56) **References Cited**

U.S. PATENT DOCUMENTS

D176,226 S	11/1955	Morris
D185,526 S	6/1959	Alvey
D204,026 S	3/1966	Lorenzen
D207,800 S	5/1967	Roberts
D211,933 S	8/1968	Horne
D212,458 S	10/1968	Sterges
3,468,447 A	9/1969	Smalley
D217,058 S	3/1970	Marsh
D227,344 S	6/1973	Lerner
D229,546 S	12/1973	Plummer
D245,225 S	8/1977	Lyons
D254,652 S	4/1980	Shortino
D268,896 S	5/1983	Sledge
D277,734 S	2/1985	Harris
D277,823 S	3/1985	Harris
D278,122 S	3/1985	Harris

D286,984 S	12/1986	Durand
D329,383 S	9/1992	Boucheron
D336,237 S	6/1993	Rossi
D337,275 S	7/1993	Tutssel
D338,828 S	8/1993	Segati

(Continued)

FOREIGN PATENT DOCUMENTS

AU	122034	11/1994
AU	128474	10/1996

(Continued)

Primary Examiner — Robert M Spear

(74) *Attorney, Agent, or Firm* — Judy W. Chung

(57) **CLAIM**

The ornamental design for a cap for a container, as shown and described.

DESCRIPTION

FIG. 1 is a front perspective view of a cap for a container according to the new design, the cap being shown in a closed state;

FIG. 2 is a front view thereof;

FIG. 3 is a rear view thereof;

FIG. 4 is a left side view thereof;

FIG. 5 is a right side view thereof;

FIG. 6 is a top view thereof;

FIG. 7 is a bottom view thereof;

FIG. 8 is a front perspective view thereof, the cap being shown in an opened state;

FIG. 9 is a front view thereof;

FIG. 10 is a rear view thereof;

FIG. 11 is a left side view thereof;

FIG. 12 is a right side view thereof;

FIG. 13 is a top view thereof; and,

FIG. 14 is a bottom view thereof.

The broken lines in the drawings represent unclaimed environmental subject matter and form no part of the claim.

1 Claim, 8 Drawing Sheets

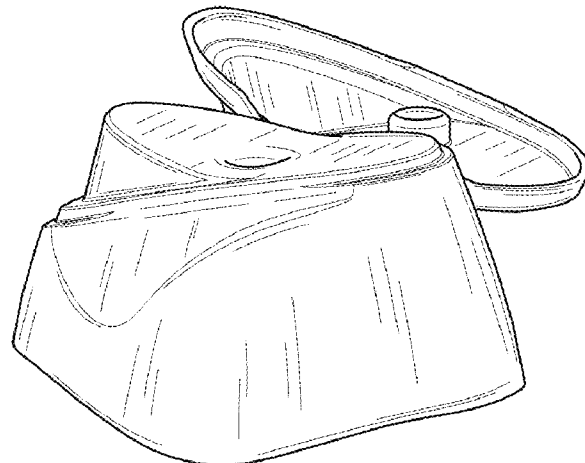
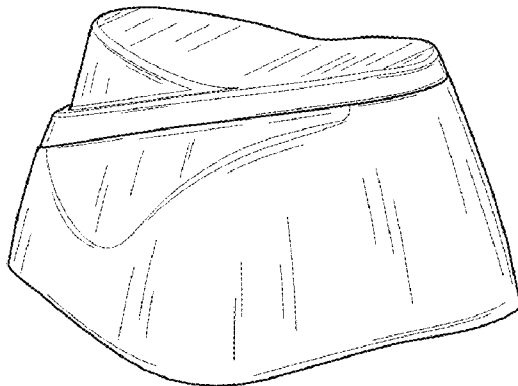

(56)

References Cited

U.S. PATENT DOCUMENTS

D342,902 S 1/1994 Granai
 D356,263 S 3/1995 Matsumoto
 D362,187 S 9/1995 Thompson
 D369,557 S 5/1996 Hiro et al.
 D376,310 S 12/1996 Crawford
 D378,665 S 4/1997 Fenton et al.
 D413,263 S 8/1999 Pritchard et al.
 D413,266 S 8/1999 Majerowski et al.
 D418,064 S 12/1999 Pritchard et al.
 D418,746 S 1/2000 Featherstone et al.
 6,039,224 A 3/2000 Dallas et al.
 D423,361 S 4/2000 Negre
 D433,339 S 11/2000 Colonna de Giovellina
 D442,854 S 5/2001 Weber
 D444,389 S 7/2001 Bakic
 D449,229 S 10/2001 Mohary et al.
 D450,593 S 11/2001 Jebb et al.
 D456,717 S 5/2002 Roher
 D461,718 S 8/2002 Brozell
 D463,744 S 10/2002 Brozell
 D467,815 S 12/2002 Cummings
 D468,214 S 1/2003 Kuzma et al.
 D470,043 S 2/2003 Crawford
 D473,141 S 4/2003 Cummings
 D485,308 S 1/2004 DeLuca et al.
 D494,870 S 8/2004 Bakic
 D498,681 S 11/2004 Fenton et al.
 D501,143 S 1/2005 Bakic
 D504,620 S 5/2005 Kazuo et al.
 D513,190 S 12/2005 Busa, Jr. et al.
 D520,873 S 5/2006 Lovell
 D526,902 S 8/2006 Cummings
 D527,640 S 9/2006 Cummings
 D527,641 S 9/2006 Bakic
 D529,810 S 10/2006 Davies et al.
 D529,812 S 10/2006 Ratzlaff
 D532,309 S 11/2006 Stolle
 D538,665 S 3/2007 Wilson et al.
 D539,141 S 3/2007 Penfold et al.
 D539,144 S 3/2007 Penfold et al.
 D546,695 S 7/2007 Penfold et al.
 D554,515 S 11/2007 Toh
 D557,146 S 12/2007 Penfold et al.
 D569,736 S 5/2008 Oates et al.
 D573,477 S 7/2008 Caldwell
 D573,887 S 7/2008 Bouroullec et al.
 D579,328 S 10/2008 Ribadeneira Mejia et al.
 D584,148 S 1/2009 Stolle
 D584,159 S 1/2009 Domoy et al.
 D585,289 S 1/2009 Toh
 D585,290 S 1/2009 Toh
 D585,739 S 2/2009 Dombrowski et al.
 D587,592 S 3/2009 Crawford
 D588,913 S 3/2009 Bakic
 D592,054 S * 5/2009 Floyd et al. D9/435
 D594,747 S 6/2009 Moretti
 D605,510 S 12/2009 Weber
 D605,511 S 12/2009 Weber
 D605,512 S 12/2009 Weber
 D605,513 S 12/2009 Weber
 D605,514 S 12/2009 Weber
 D606,867 S 12/2009 Fugate
 D608,196 S 1/2010 Beilke
 D608,197 S 1/2010 Gotsmich
 D608,639 S 1/2010 Jackel et al.
 D609,565 S * 2/2010 Floyd et al. D9/435
 D615,412 S 5/2010 Thomas et al.
 D618,554 S 6/2010 Bruscha et al.
 D629,298 S 12/2010 Wong
 D635,024 S 3/2011 Stolle
 D635,025 S 3/2011 Stolle
 D635,026 S 3/2011 Stolle
 D641,627 S 7/2011 Rosenauer
 D648,626 S 11/2011 Oates et al.
 D651,092 S 12/2011 Bowers et al.

D660,167 S 5/2012 Weaver et al.
 D662,828 S 7/2012 Jackson et al.
 D665,261 S 8/2012 Mazurkiewicz et al.
 D666,095 S 8/2012 Blachford et al.
 D666,104 S 8/2012 Cummings et al.
 D666,107 S 8/2012 Blachford et al.
 D688,130 S * 8/2013 Crawford et al. D9/529
 D688,131 S * 8/2013 Crawford et al. D9/529
 D688,558 S * 8/2013 Crawford et al. D9/529
 D691,042 S * 10/2013 Crawford et al. D9/449
 D691,043 S * 10/2013 Crawford et al. D9/449
 D691,044 S * 10/2013 Toh et al. D9/449
 D691,045 S * 10/2013 Toh et al. D9/449
 D694,624 S * 12/2013 Crawford et al. D9/449

FOREIGN PATENT DOCUMENTS

AU 136636 3/1999
 AU 144335 7/2001
 AU 148421 7/2002
 AU 148422 7/2002
 AU 148967 8/2002
 AU 152740 8/2003
 AU 155767 6/2004
 AU 157721 3/2005
 AU 317525 1/2008
 AU 317529 1/2008
 AU 318358 3/2008
 AU 329204 1/2010
 AU 333674 11/2010
 BR DI5500237-4 6/1997
 BR DI5500411-3 6/1999
 BR DI6500233-4 F 7/2005
 BR DI6703669-4 F 4/2008
 CA ID93401 9/2001
 CA ID94298 12/2001
 CA ID101916 12/2003
 CA ID103089 1/2006
 CA ID109736 7/2006
 EM 000048475-0001 6/2003
 EM 000112586-0001 12/2003
 EM 000145446-0005 3/2004
 EM 000145446-0014 3/2004
 EM 000145446-0015 3/2004
 EM 000226774-0001 9/2004
 EM 000294038-0002 2/2005
 EM 000354766-0001 6/2005
 EM 000494059-0002 3/2006
 EM 000514716-0001 4/2006
 EM 000514716-0002 4/2006
 EM 000514716-0003 4/2006
 EM 000530845-0002 5/2006
 EM 000546452-0001 6/2006
 EM 000546452-0003 6/2006
 EM 000623731-0002 11/2006
 EM 000663844-0001 2/2007
 EM 000780416-0011 8/2007
 EM 000824925-0009 11/2007
 EM 001031017-0001 10/2008
 EM 001139281-0001 5/2009
 EM 001608860-0001 9/2009
 EM 001609165-0001 9/2009
 EM 001181440-0006 11/2009
 EM 001207971-0001 4/2010
 EM 001850405-0001 4/2011
 EM 001896739-0001 7/2011
 EM 001896739-0005 7/2011
 JP D1270533 3/2006
 JP D1284947 9/2006
 JP D1297607 3/2007
 JP D1373526 10/2009
 JP D1373527 10/2009
 KR 300433701.0000 12/2006
 KR 300459058.0000 8/2007
 KR 300534910.0000 7/2009
 KR 300643859.0000 5/2012
 RU 50313 5/2002
 RU 53318 10/2003
 RU 54584 6/2004

(56)

References Cited

FOREIGN PATENT DOCUMENTS

RU	55622	11/2004
RU	56617	4/2005
RU	56618	4/2005
RU	57358	8/2005
RU	57360	8/2005
RU	57587	9/2005
RU	65541	2/2008
RU	69852	4/2009
RU	69858	4/2009
RU	78087	4/2011
RU	79255	8/2011

TR	9483	9/2000
TR	200300267	2/2003
TR	200303620	11/2003
TR	200502903	7/2005
TR	200503087	8/2005
TR	200604584	10/2006
TR	200605507	12/2006
TR	200705900	11/2007
TR	200802307	4/2008
TR	200804579	8/2008
TR	200806202	12/2008
TR	200900444	2/2009
TR	201000712	2/2010
TR	201003002	5/2010

* cited by examiner

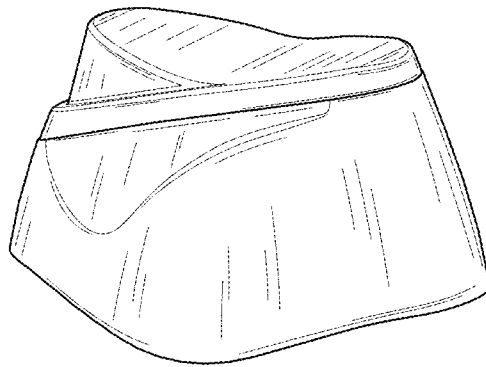

FIG. 1

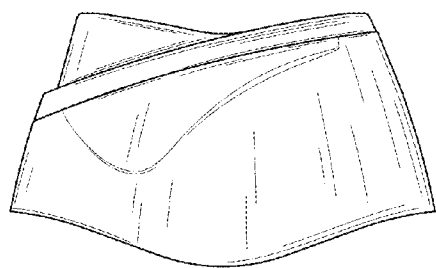

FIG. 2

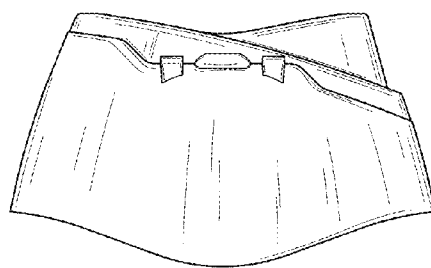

FIG. 3

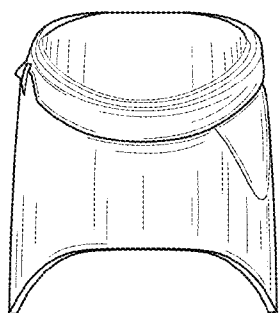

FIG. 4

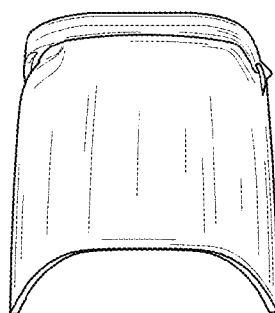

FIG. 5

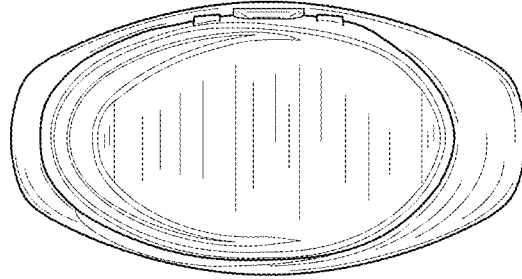

FIG. 6

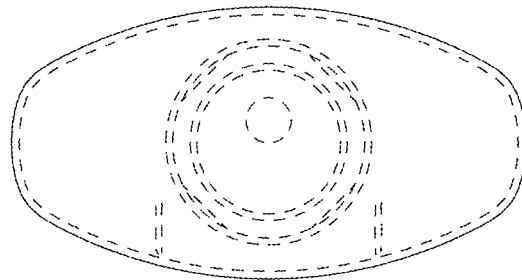

FIG. 7

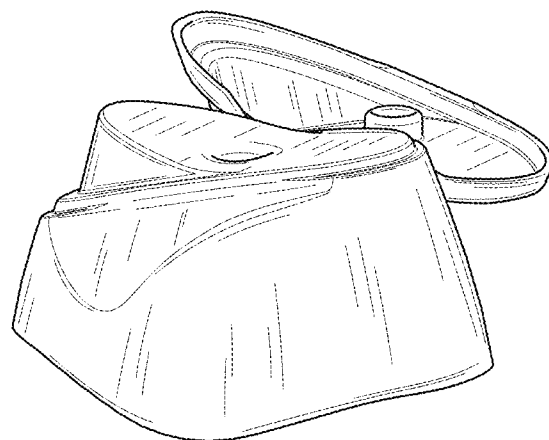

FIG. 8

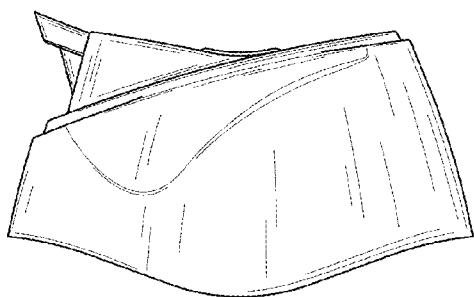

FIG. 9

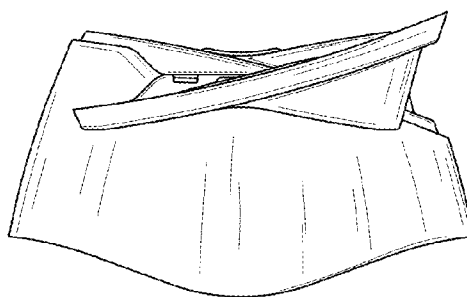

FIG. 10

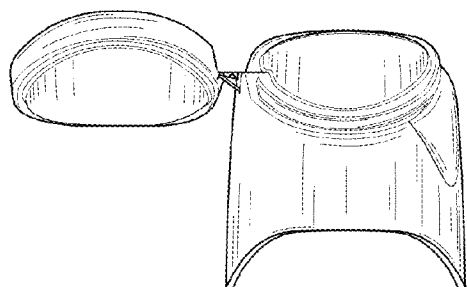

FIG. 11

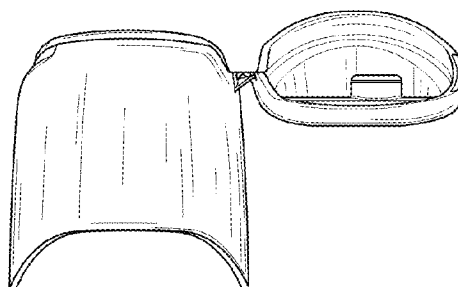

FIG. 12

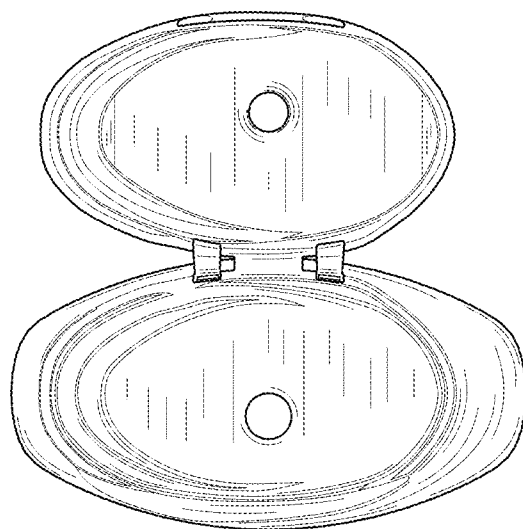

FIG. 13

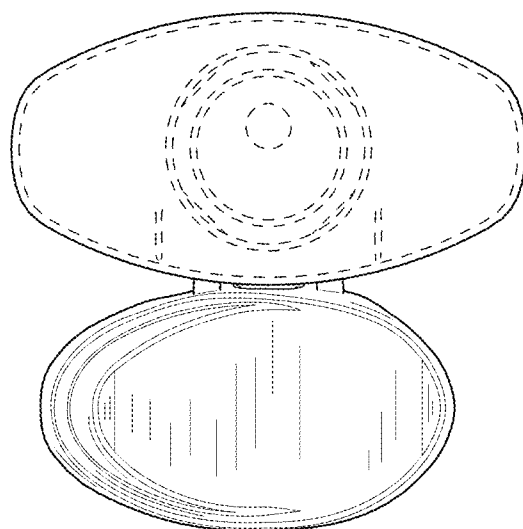

FIG. 14