



US00RE49694E

(19) **United States**  
(12) **Reissued Patent**  
**Post**

(10) **Patent Number:** **US RE49,694 E**  
(45) **Date of Reissued Patent:** **Oct. 17, 2023**

(54) **SANDAL**

OTHER PUBLICATIONS

(71) Applicant: **Birkenstock IP GmbH**, Linz (DE)

Birkenstock, "Arizona", [https://www.birkenstock.com/us/arizona-birko-flor-nubuck/arizona-core-birkoflornubuck-0-eva-u\\_650.html#lang=en\\_US&q=arizona](https://www.birkenstock.com/us/arizona-birko-flor-nubuck/arizona-core-birkoflornubuck-0-eva-u_650.html#lang=en_US&q=arizona); available at least as early as Oct. 11, 2016; date accessed Sep. 20, 2022.

(72) Inventor: **Uta Post**, Cologne (DE)

(Continued)

(73) Assignee: **BIRKENSTOCK IP GMBH**, Linz am Rhein (DE)

*Primary Examiner* — Darlington Ly

(21) Appl. No.: **29/803,430**

(74) *Attorney, Agent, or Firm* — Fross, Zelnick, Lehrman & Zissu PC; Charles T. J. Wiegell, Esq.

(22) Filed: **Aug. 12, 2021**

(57) **CLAIM**

The ornamental design for a sandal, shown and described.

**Related U.S. Patent Documents**

Reissue of:

(64) Patent No.: **Des. 855,950**  
Issued: **Aug. 13, 2019**  
Appl. No.: **35/503,896**  
Filed: **Oct. 12, 2017**

**DESCRIPTION**

(51) **LOC (14) Cl.** ..... **02-04**

- [1. Sandal]**
- [1.1 : Perspective]**
- [1.2 : Right]**
- [1.3 : Left]**
- [1.4 : Back]**
- [1.5 : Front]**
- [1.6 : Top]**
- [1.7 : Bottom]**

(52) **U.S. Cl.**

USPC ..... **D2/916**

(58) **Field of Classification Search**

USPC ..... D2/896-900, 902-908, 916-918, 946,  
D2/951, 969, 972-974

CPC ..... A43B 3/10; A43B 3/12

See application file for complete search history.

*1.1 is a front perspective view of a sandal embodying my new design;*  
*1.2 is a right side elevation view thereof;*  
*1.3 is a left side elevation view thereof;*  
*1.4 is a rear elevation view thereof;*  
*1.5 is a front elevation view thereof;*  
*1.6 is a top plan view thereof; and*  
*1.7 is a bottom plan view thereof.*

(56) **References Cited**

**U.S. PATENT DOCUMENTS**

3,063,457 A \* 11/1962 Bittner ..... A43B 7/145  
D2/916  
D268,455 S \* 4/1983 Famolare, Jr. .... D2/918  
D275,429 S \* 9/1984 Nakao ..... D2/918  
D294,076 S \* 2/1988 Birrittella ..... D2/918  
5,465,506 A \* 11/1995 Matis ..... A43C 11/00  
D2/916

**1 Claim, 7 Drawing Sheets**

**Matter enclosed in heavy brackets [ ] appears in the original patent but forms no part of this reissue; matter printed in italics indicates the additions made by reissue.**

(Continued)

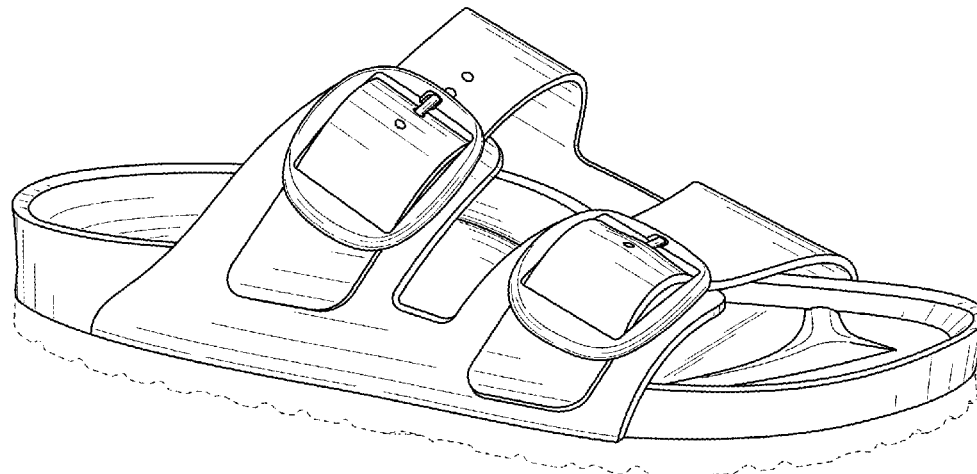

**(AMENDED)**

(56)

References Cited

U.S. PATENT DOCUMENTS

5,561,919 A \* 10/1996 Gill ..... A43B 13/12  
 36/11.5  
 D375,615 S \* 11/1996 McDonald ..... D2/916  
 5,687,492 A \* 11/1997 Muraoka ..... A43B 5/14  
 36/11.5  
 D416,128 S \* 11/1999 Kelchak ..... D2/916  
 6,122,845 A \* 9/2000 Menghi ..... A43C 11/16  
 36/114  
 6,256,906 B1 \* 7/2001 Matis ..... A43B 3/126  
 36/11.5  
 D513,838 S \* 1/2006 Birkenstock ..... D2/916  
 D575,942 S \* 9/2008 del Biondi ..... D2/916  
 D576,387 S \* 9/2008 del Biondi ..... D2/916  
 D577,882 S \* 10/2008 Little ..... D2/916  
 8,839,529 B1 \* 9/2014 Levy ..... A43B 3/248  
 24/442  
 D732,806 S \* 6/2015 Maritan ..... D2/916  
 D747,080 S \* 1/2016 Santos ..... D2/927  
 D781,540 S \* 3/2017 Mitchell ..... D2/916

D792,684 S \* 7/2017 Gurt ..... D2/916  
 D801,010 S \* 10/2017 Armellin ..... D2/916  
 D855,950 S \* 8/2019 Post ..... D2/916  
 D874,101 S \* 2/2020 Post ..... D2/916  
 D876,758 S \* 3/2020 Brinkhof ..... D2/916  
 D878,718 S \* 3/2020 Post ..... D2/916  
 D880,116 S \* 4/2020 Post ..... D2/916  
 D919,247 S \* 5/2021 Post ..... D2/951  
 2002/0088141 A1 \* 7/2002 Matis ..... A43B 3/128  
 36/12  
 2002/0124433 A1 \* 9/2002 Pan ..... A43B 3/122  
 36/11.5  
 2021/0153596 A1 \* 5/2021 Voggenauer ..... A43B 9/00

OTHER PUBLICATIONS

[Online] "Arizona Birko Flor" [https://www.birkenstock.com/us/arizona-birko-flor/arizona-magicsnake-birkoflor-0-eva-w.html?dwvar\\_arizona-magicsnake-birkoflor-0-eva-w\\_color=817](https://www.birkenstock.com/us/arizona-birko-flor/arizona-magicsnake-birkoflor-0-eva-w.html?dwvar_arizona-magicsnake-birkoflor-0-eva-w_color=817). Retrieved Sep. 15, 2018.\*

\* cited by examiner

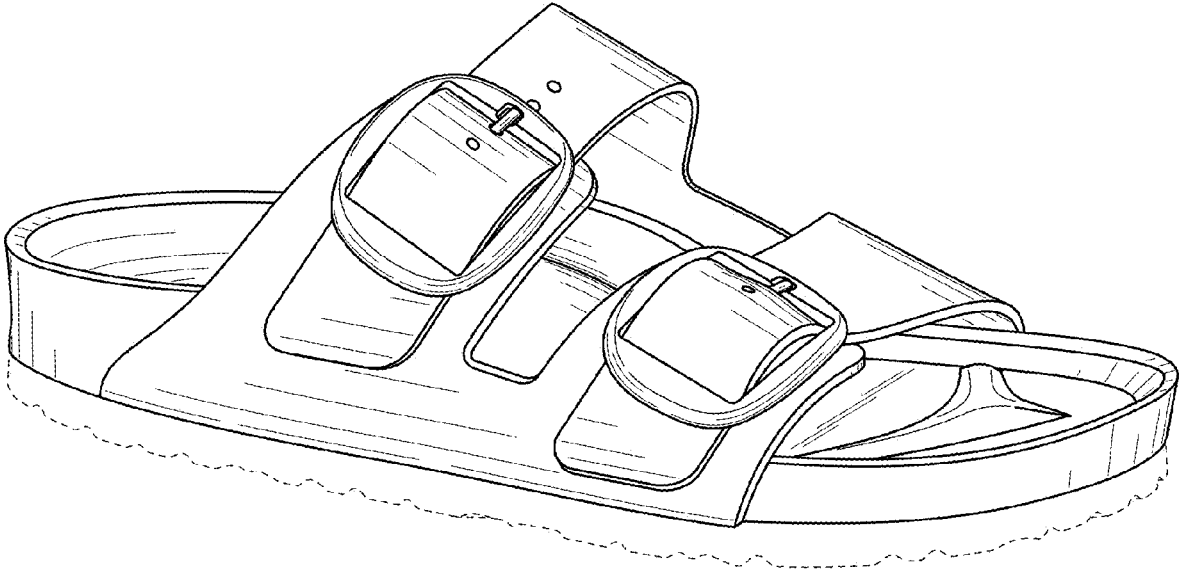

**1.1**  
**(AMENDED)**

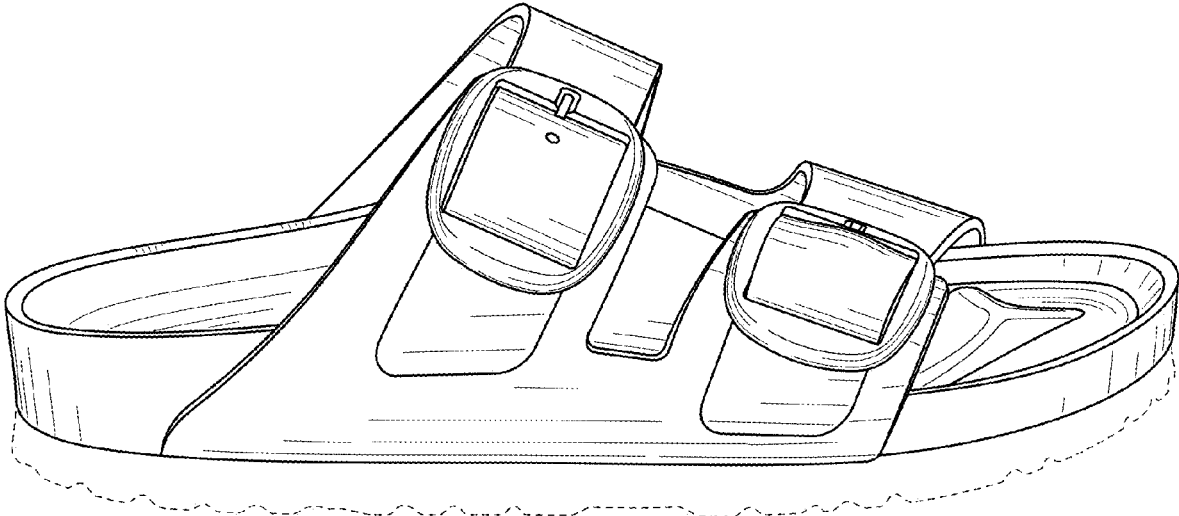

**1.2**  
**(AMENDED)**

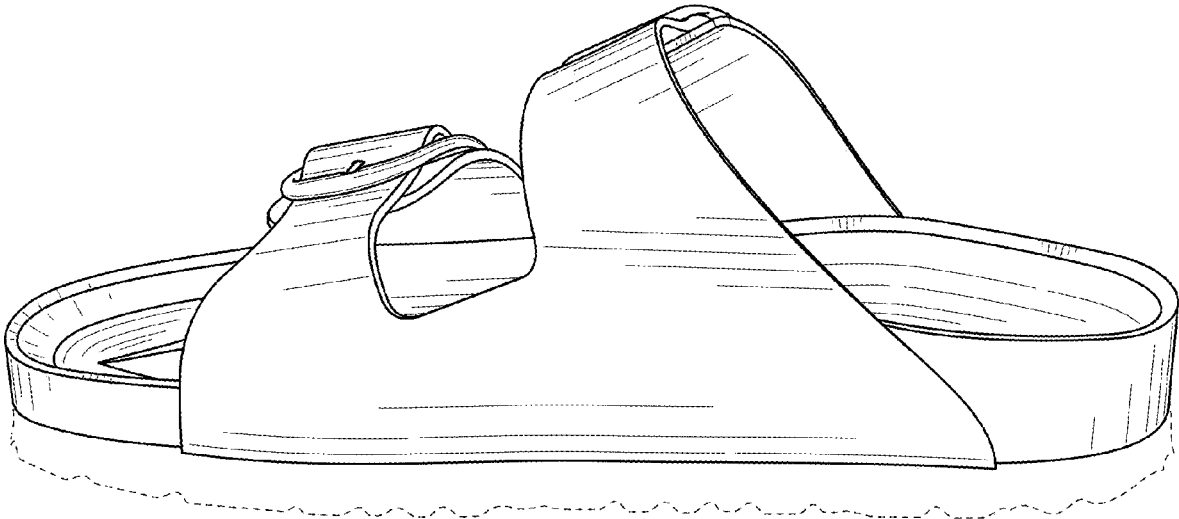

**1.3**  
**(AMENDED)**

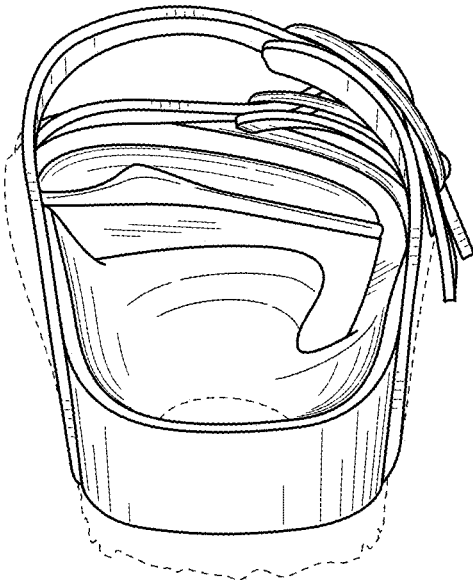

**1.4**  
**(AMENDED)**

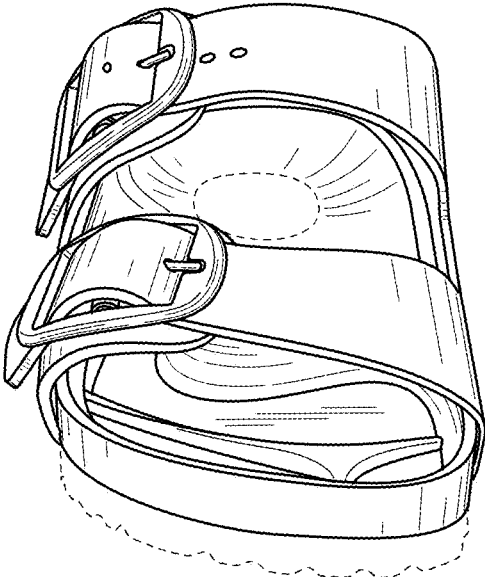

**1.5**  
**(AMENDED)**

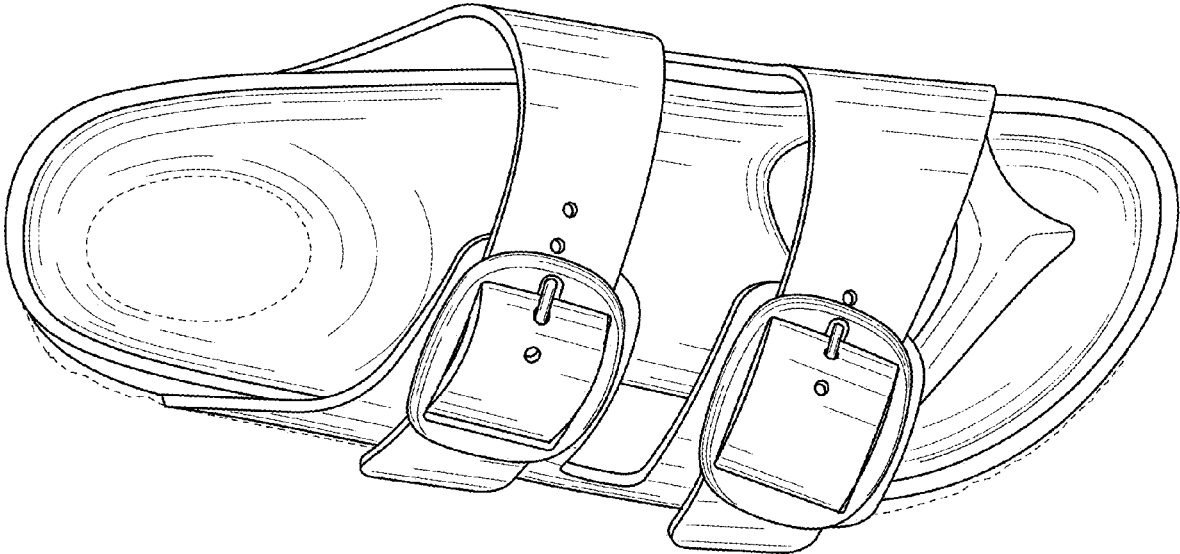

**1.6**  
**(AMENDED)**

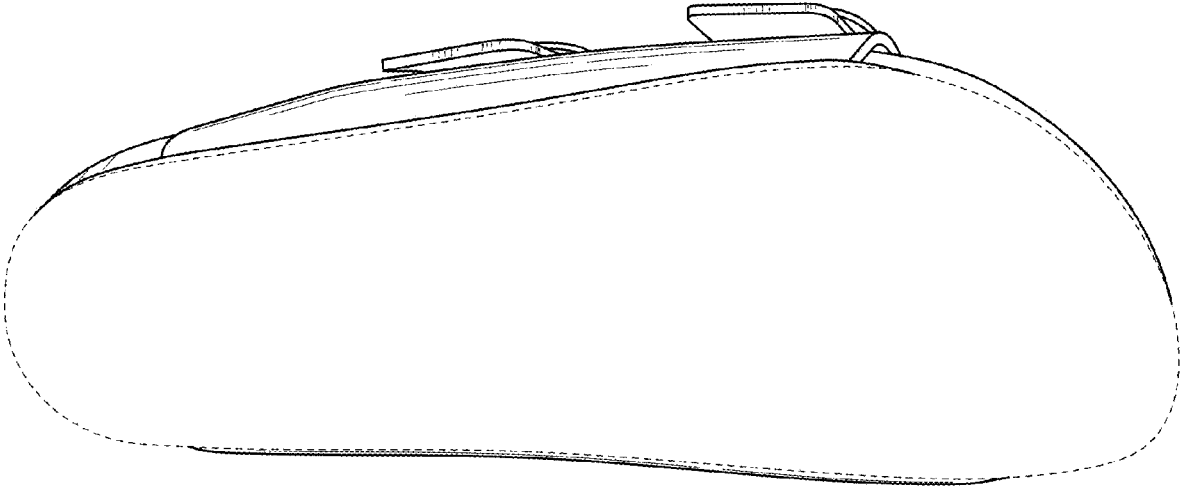

**1.7**  
**(AMENDED)**