



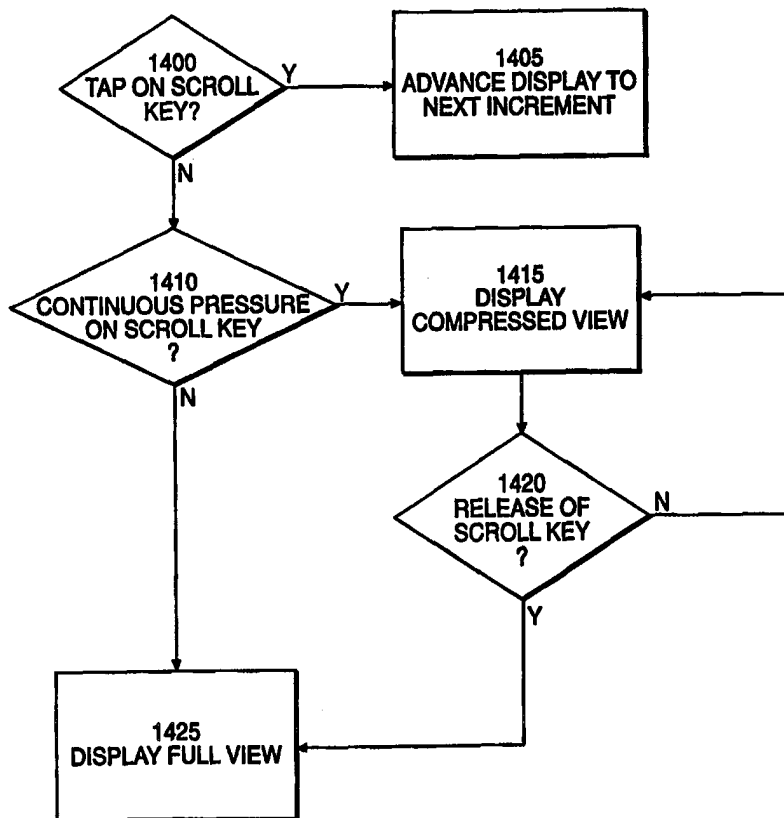
INTERNATIONAL APPLICATION PUBLISHED UNDER THE PATENT COOPERATION TREATY (PCT)

<p>(51) International Patent Classification ⁶ : H04M 1/274, G06F 3/023</p>	<p>A1</p>	<p>(11) International Publication Number: WO 98/48552 (43) International Publication Date: 29 October 1998 (29.10.98)</p>
<p>(21) International Application Number: PCT/IB98/00773 (22) International Filing Date: 21 April 1998 (21.04.98) (30) Priority Data: 08/841,486 23 April 1997 (23.04.97) US (71) Applicant: NORTHERN TELECOM LIMITED [CA/CA]; P.O. Box 6123, Station A, Montreal, Quebec H3C 3J5 (CA). (72) Inventors: SMITH, Colin, Donald; 565 Athlone Avenue, Ottawa, Ontario K1Z 5N1 (CA). BEATON, Brian, Finlay; 6136 Silver Birch Street, Orleans, Ontario K1W 1C4 (CA).</p>	<p>(81) Designated States: BR, CA, CN, IL, JP, KR, MX, VN, European patent (AT, BE, CH, CY, DE, DK, ES, FI, FR, GB, GR, IE, IT, LU, MC, NL, PT, SE). Published <i>With international search report. Before the expiration of the time limit for amending the claims and to be republished in the event of the receipt of amendments.</i></p>	

(54) Title: SCROLLING WITH AUTOMATIC COMPRESSION AND EXPANSION

(57) Abstract

A method of managing information display by compressing an amount of information displayed, the method comprising the steps of: storing in a memory a directory of entries each including a plurality of fields; displaying the directory; activating a scrolling mechanism to scroll the entries of the directory; displaying a selected one of the fields of the entries when the scrolling mechanism is activated; receiving a user input releasing the scrolling mechanism; and displaying other ones of the fields associated with the entries when the scrolling mechanism is released.



FOR THE PURPOSES OF INFORMATION ONLY

Codes used to identify States party to the PCT on the front pages of pamphlets publishing international applications under the PCT.

AL	Albania	ES	Spain	LS	Lesotho	SI	Slovenia
AM	Armenia	FI	Finland	LT	Lithuania	SK	Slovakia
AT	Austria	FR	France	LU	Luxembourg	SN	Senegal
AU	Australia	GA	Gabon	LV	Latvia	SZ	Swaziland
AZ	Azerbaijan	GB	United Kingdom	MC	Monaco	TD	Chad
BA	Bosnia and Herzegovina	GE	Georgia	MD	Republic of Moldova	TG	Togo
BB	Barbados	GH	Ghana	MG	Madagascar	TJ	Tajikistan
BE	Belgium	GN	Guinea	MK	The former Yugoslav Republic of Macedonia	TM	Turkmenistan
BF	Burkina Faso	GR	Greece	ML	Mali	TR	Turkey
BG	Bulgaria	HU	Hungary	MN	Mongolia	TT	Trinidad and Tobago
BJ	Benin	IE	Ireland	MR	Mauritania	UA	Ukraine
BR	Brazil	IL	Israel	MW	Malawi	UG	Uganda
BY	Belarus	IS	Iceland	MX	Mexico	US	United States of America
CA	Canada	IT	Italy	NE	Niger	UZ	Uzbekistan
CF	Central African Republic	JP	Japan	NL	Netherlands	VN	Viet Nam
CG	Congo	KE	Kenya	NO	Norway	YU	Yugoslavia
CH	Switzerland	KG	Kyrgyzstan	NZ	New Zealand	ZW	Zimbabwe
CI	Côte d'Ivoire	KP	Democratic People's Republic of Korea	PL	Poland		
CM	Cameroon	KR	Republic of Korea	PT	Portugal		
CN	China	KZ	Kazakstan	RO	Romania		
CU	Cuba	LC	Saint Lucia	RU	Russian Federation		
CZ	Czech Republic	LI	Liechtenstein	SD	Sudan		
DE	Germany	LK	Sri Lanka	SE	Sweden		
DK	Denmark	LR	Liberia	SG	Singapore		
EE	Estonia						

- 1 -

SCROLLING WITH AUTOMATIC COMPRESSION AND EXPANSION
RELATED APPLICATIONS

This application is related to U.S. patent application, Serial No. 08/842,015 (Atty. Docket No. 3884.0085-00), entitled MULTITASKING GRAPHICAL USER INTERFACE; U.S. patent application, Serial No.08/841,485 (Atty. Docket No. 3884.0086-00), entitled ELECTRONIC BUSINESS CARDS; U.S. patent application, Serial No.08/842,019 (Atty. Docket No. 3884.0088-00), entitled CALLING LINE IDENTIFICATION WITH LOCATION ICON; U.S. patent application, Serial No.08/842,017 (Atty. Docket No. 3884.0089-00), entitled CALLING LINE IDENTIFICATION WITH DRAG AND DROP CAPABILITY; U.S. patent application, Serial No. 08/842,020 (Atty. Docket No. 3884.0090-00), entitled INTEGRATED MESSAGE CENTER; and U.S. patent application, Serial No.08/842,036 (Atty. Docket No. 3884.0091-00), entitled ICONIZED NAME LIST, all of which are filed concurrently herewith, and all of which are hereby incorporated by reference.

BACKGROUND OF THE INVENTION

The present invention relates generally to graphical user interfaces in telephony, and more particularly to scrolling lists with automatic compression and expansion.

In light of the rapid technological developments and globalization of the world economy, the role of telecommunication is becoming increasingly important. As such, there is a growing focus on using state of the art computer technology to provide new and improved telecommunication capabilities. The capability of combining voice and digital data transmission is enabled by the GSM (Global System for Mobile Communications) protocol.

One popular feature, commonly referred to as Caller ID or CLID (Calling Line Identification), displays the caller's name and telephone number on the receiver's device as shown in Fig. 1. CLID information is stored at a public telephone network and delivered to the receiver's display device if the receiver subscribes to the Caller ID feature.

- 2 -

There are also telephones that can store a list containing names, multiple telephone numbers, and address information. PDAs (Personal Digital Assistants), provide graphical icons associated with particular telephone numbers.

5 Also available today are communicators that facilitate various types of communication such as voice, faxes, SMS (Short Messaging Services) messages, and Internet-related applications. One such product offers a "contacts" feature for managing contact information including names, telephone numbers, and addresses. It also allows exchanging contact information as business cards in an SMS message.

10 Conventional devices, however, have two distinct modes of operation: open and closed. When closed, the product operates as a telephone and the user cannot access the display of the contacts cards. To display the contacts cards, the product must be open and in hands-free mode. When the product is open, if the phone part of the product was not previously turned on, the user must close the
15 product and turn on the phone part of the product, then reopen the product in PDA mode to make a call.

Additionally, the product has separate, distinct applications that handle each type of communication tasks. The distributed interface of the product is highly compartmentalized by applications, thus restricting the sharing of
20 information between applications. Specifically, the telephone application and contacts application are completely independent and must be launched separately. Because the two applications do not share information, it sometimes requires the user to input the same information in both applications. Furthermore, features of each application may only be activated within the respective application.

25 When a user is in a telephone application, for example, a user cannot manipulate a contacts card. Therefore, to modify or update a contacts card information, the user must launch a contacts application. Similarly, the user can initiate a call only from a telephone application and not from a contacts card. Even if a user enters a telephone number in a telephone application, this
30 information cannot be saved in a contacts application as a new contacts card.

Likewise, the product does not allow information to be shared between the telephone application and the contacts application.

To create a contacts card, the user must launch the contacts application, select "logs," choose a communication event (such as call received), then press
5 "create card" to create a new contacts card. Even so, these series of steps only transfers the telephone number but not the associated name to a new contacts card, and any additional information must be entered within the contacts application. To initiate a call, the user must leave the contacts application by pressing the hard key for "telephone." The telephone directory displays only the names but not
10 related fields.

Current telecommunication features also do not take full advantage of CLID information. Specifically, CLID information is used for display purposes only in providing information to the receiver about the caller. After the CLID information is displayed, it cannot be manipulated, transferred to another device or
15 user, or used in other application programs.

Additionally, besides the name and the number of the caller, CLID does not provide additional information that further defines the type of communication device or the location of the caller. For example, the receiver may not know or remember whether the displayed number is a wireline or wireless, or a work or
20 home telephone number. This type of information would further assist the receiver in determining the caller's device and location, thus, further defining the importance of the call.

Generally, telephone networks only transmit the caller's CLID information to the receiver. There are currently some private networks that transmit CLID
25 information to both the caller and the receiver. As mentioned above, however, the transmitted CLID information has been limited to only the name and the number of the other party.

Moreover, directories are stored in the memory of the communication device, which generally has limited storage capacity. This restricts the device's
30 ability to store a desired amount of information in the device. Related to this problem is the need to store information at different locations within the device.

- 4 -

For example, speed dial data is stored separately from the main directory data. Not only does this duplicate the data entry process, data maintenance and updates need to be performed for each location to avoid unsynchronization of the data.

Searching for an entry in the directory can also be tedious. Unless the user
5 remembers the name of the entry and conducts a text search for the desired entry, the user must scroll through each entry sequentially. In doing so, if each entry contains many related fields, scrolling through each entry while displaying other unnecessary fields reduces the efficiency of the search. Not only does this slow down the search significantly, it also makes the search more difficult.
10 Additionally, the directory does not present additional information that further defines the type of communication device or the location of the caller in an easily recognizable manner.

Therefore, it is desirable to integrate various telecommunication applications to simplify user interfaces and facilitate efficient information sharing.

15 It is also desirable to manipulate the CLID information to provide enhanced user interfaces.

It is further desirable to provide additional information related to the CLID to better identify the caller's identity and location of the call.

In addition, it is further desirable to improve the search feature to scroll
20 through the directory more easily.

SUMMARY OF THE INVENTION

Systems and methods consistent with the present invention automatically compress and expand the display of the directory during scrolling.

Specifically, a method for managing information display consistent with
25 this invention comprises several steps. First, a directory of entries each including a plurality of fields is stored in a memory. A scrolling mechanism is then activated to scroll the entries, displaying a selected one of the fields of the entries. Finally, a user input releasing the scrolling mechanism is received, triggering the display of other ones of the fields associated with the particular entry.

30 A system for managing information display comprises a database, an activating means, a first and second displaying means, and a receiving means. The

database stores a directory of entries each including a plurality of fields and the activating means activates a scrolling mechanism to scroll the entries. The first means for displaying displays a selected one of the fields of the entries when the scrolling mechanism is activated. The receiving means receives user input
5 releasing the scrolling mechanism, which causes the second displaying means to display other ones of the fields associated with the particular entry when the scrolling mechanism is released.

BRIEF DESCRIPTION OF THE DRAWINGS

The accompanying drawings, which are incorporated in and constitute a
10 part of this specification, illustrate the invention and together with the description, serve to explain the principles of the invention.

In the drawings,

Fig. 1 shows a prior art CLID display;

Fig. 2 is a diagram of a communication network consistent with the
15 principles of the present invention;

Fig. 3 is a diagram of a mobile telephone shown in Fig. 2;

Fig. 4 is a block diagram showing the elements of the mobile telephone of
Fig. 3;

Fig. 5 is a block diagram showing the components of the memory of Fig.
20 4;

Fig. 6 is a table illustrating the format of the information stored in the
directory;

Fig. 7 is a flowchart illustrating the process for creating a new Electronic
Business Card (EBC);

25 Figs. 8A-8D show sample screens for creating a new EBC;

Fig. 9 is a table illustrating exemplary icons;

Fig. 10 is a sample screen for creating or modifying an icon;

Figs. 11A-11B show sample screens illustrating a completed EBC;

Figs. 12A-12C show sample screens for creating an EBC using CLID
30 information;

Figs. 13A-13B show sample screens of the directory view of the entries;

- 6 -

Fig. 14 is a flowchart illustrating the process for the scrolling feature;

Figs. 15A-15B show sample screens of compressed and expanded view of the directory during scroll;

Fig. 16 is a flowchart illustrating the process for transmitting an EBC;

5 Figs. 17A-17B show sample screens for sending an EBC;

Figs. 18A-18B show sample screens for receiving an EBC;

Fig. 19 is a flowchart illustrating the process for the drag-and-drop feature;

Figs. 20A-20B show sample screens showing the drag-and-drop feature;

and

10 Figs. 21A-21B show sample screens illustrating an exemplary application of the drag-and-drop feature.

DESCRIPTION OF THE PREFERRED EMBODIMENT

Reference will now be made in detail to the present preferred embodiment of the invention, an example of which is illustrated in the accompanying drawings.

15 Where appropriate, the same reference numerals refer to the same or similar elements. While the appended claims define the scope of the invention, the following description does not limit that scope.

System Architecture

20 Fig. 2 shows a communications network containing mobile telephone 210 preferably having the multitasking graphical user interface of the present invention. A user communicates with a variety of communication equipment, including external servers and databases, such as network services provider 220, using mobile telephone 210.

25 The user also uses mobile telephone 210 to communicate with callers having different types of communication equipment, such as ordinary telephone 230, caller mobile telephone 240, similar to user mobile telephone 210, facsimile equipment 250, computer 260, and Analog Display Services Interface (ADSI) telephone 270. The user communicates with network services provider 220 and caller communication equipment 230 through 270 over a communications
30 network, such as GSM switching fabric 280. Fig. 2 shows caller communication equipment 230 through 270 directly connected to GSM switching fabric 280.

Although Fig. 2 shows caller communication equipment 230 through 270 directly connected to GSM switching fabric 280, more typically, this equipment connects to GSM switching fabric 280 via another type of network, such as a Public Switched Telephone Network (PSTN).

5 The user communicates with a caller or network services provider 220 by establishing either a voice call, a data call, or by sending an SMS message. GSM networks provide an error-free, guaranteed delivery transport mechanism by which callers can send short point-to-point messages, *i.e.*, SMS messages, through the GSM network, such as GSM switching fabric 280, in a GSM signaling channel,
10 simultaneously with, or without, a voice or data call. GSM protocol limits the length of the short messages to a maximum of 140 bytes in length. GSM protocol limits the length of the standard SMS text message to a maximum of 140 bytes. However, GSM protocol permits longer messages to be formed by concatenating several messages together, transparent to the caller. Because GSM protocol
15 performs concatenation transparently, the caller is not subject to any restriction on message length.

GSM telephone networks can transfer data as CLID information and USSD. One example of such network is the GSM network, which facilitates the transfer of custom defined data. The switches handling the call, however, require
20 an application program, consistent with the standard industry practice, capable of recognizing the USSD data structure to complete the transfer of data from one device to another device.

Mobile telephone 210 provides a user-friendly interface to facilitate incoming and outgoing communication by the user. Fig. 3 shows that mobile
25 telephone 210 includes main housing 310, antenna 320, keypad 330, and display 340.

Fig. 4 shows the hardware elements in mobile telephone 210 include antenna 410, communications module 420, feature processor 430, memory 440, sliding keypad 450, analog controller 460, display module 470, battery pack 480,
30 and switching power supply 490.

Antenna 410 transmits and receives radio frequency information for mobile telephone 210. Antenna 410 preferably comprises a planar inverted F antenna (PIFA)-type or a short stub (2 to 4 cm) custom helix antenna. Antenna 410 communicates over GSM switching fabric 280 using a conventional voice B-
5 channel, data B-channel, or GSM signaling channel connection.

Communications module 420 connects to antenna 410 and provides the GSM radio, baseband, and audio functionality for mobile telephone 210.

Communications module 420 includes GSM radio 421, VEGA 423, BOCK 425, and audio transducers 427.

10 GSM radio 421 converts the radio frequency information to/from the antenna into analog baseband information for presentation to VEGA 423. VEGA 423 is preferably a Texas Instruments VEGA device, containing analog-to-digital (A/D)/digital-to-analog (D/A) conversion units 424. VEGA 423 converts the analog baseband information from GSM radio 421 to digital information for
15 presentation to BOCK 425.

BOCK 425 is preferably a Texas Instruments BOCK device containing a conventional ARM microprocessor and a conventional LEAD DSP device. BOCK 425 performs GSM baseband processing for generating digital audio signals and supporting GSM protocols. BOCK 425 supplies the digital audio
20 signals to VEGA 423 for digital-to-analog conversion. VEGA 423 applies the analog audio signals to audio transducers 427. Audio transducers 427 include speaker 428 and microphone 429 to facilitate audio communication by the user.

Feature processor 430 provides graphical user interface features and a Java Virtual Machine (JVM). Feature processor 430 communicates with BOCK 425
25 using high level messaging over an asynchronous (UART) data link. Feature processor 430 contains additional system circuitry, such as a liquid crystal display (LCD) controller, timers, UART and bus interfaces, and real time clock and system clock generators (not shown).

Memory 440 stores data and program code used by feature processor 430.
30 Memory 440 includes static RAM 442 and flash ROM 444. Static RAM 442 is a volatile memory that stores data and other information used by feature processor

430. Flash ROM 444, on the other hand, is a non-volatile memory that stores the program code executed by feature processor 430.

Sliding keypad 450 enables the user to dial a telephone number, access remote databases, and manipulate the graphical user interface features. Sliding keypad 450 preferably includes a mylar resistive key matrix that generates analog resistive voltage in response to actions by the user. Sliding keypad 450 preferably connects to main housing 310 (Fig. 4) of mobile telephone 210 through two mechanical "push pin"-type contacts.

Analog controller 460 is preferably a Phillips UCB1100 device that acts as an interface between feature processor 430 and sliding keypad 450. Analog controller 460 converts the analog resistive voltage from sliding keypad 450 to digital signals for presentation to feature processor 430.

Display module 470 is preferably a 160 by 320 pixel LCD with an analog touch screen overlay and an electroluminescent backlight. Display module 470 operates in conjunction with feature processor 430 to display the graphical user interface features.

Battery pack 480 is preferably a single lithium-ion battery with active protection circuitry. Switching power supply 490 ensures highly efficient use of the lithium-ion battery power by converting the voltage of the lithium-ion battery into stable voltages used by the other hardware elements of mobile telephone 210.

Fig. 5 is a block diagram illustrating the components of memory 440. Static RAM 442 contains a database 510 storing various types of data including a table representing a telephone directory.

Flash ROM 444 contains various programs including a program 520, a dialpad program 525, a handwriting recognition program 530, an icon edit program 535, and a call object program 540. Program 520, preferably written in languages such as Java, C, or C++ for Macintosh, is a main program overseeing the operation of mobile telephone 210.

Dialpad program 525 facilitates data entry using keypad 330 using a typical keypad algorithm. Handwriting recognition program 530 recognizes and translates handwriting input from display 340. Icon edit program 535 facilitates

graphical input as bitmaps. Programs 525, 530, and 535 may be one of any commercially available packages. Finally, call object program 540 may be a user-defined special feature program or a macro for telephony.

5 Currently, CLID information is stored in a telephone network and delivered to the receiver's device. Mobile telephone 210, consistent with the present invention, stores and interacts with highly descriptive information in database 510 of Fig. 5. Alternatively, all or part of the descriptive information may be stored at an external device or a central server.

10 Table 600 of Fig. 6 is a table illustrating the format of the information stored. Each row represents a single entry and each column within a row represents a field of the entry. In one embodiment of the present invention, table 600 contains many fields including fields for the name of the person, title of the person, name of the organization, communication addresses or numbers (*e.g.*, multiple telephone numbers, fax number, e-mail address) as well as their
15 associated icon, and a field for user-defined text. For exemplary purposes, features of the present invention may be explained using a telephone number. However, telephone number is used hereinafter to refer to any communication address or number. Program 520 displays each entry containing the fields in Fig. 6 in the form of a business card (hereinafter referred as Electronic Business Card or EBC). EBCs, including location icons, may be formatted as USSD
20 (Unstructured Supplementary Service Data) and may be transmitted among users in the GSM network.

Fig. 7 shows a flowchart for creating a new EBC, and Figs. 8A-8D show sample screens. First, a user selects a "Name List" icon in screen 810 (step 700),
25 which in turn displays an action menu 811 as shown in Fig. 8A (step 705). A display driver oversees the display in display 340. If the user selects a "Create card" option (step 710), program 520 presents screen 820 from which the user may enter the data for the new EBC (step 715).

The present invention facilitates many modes of data entry. For example,
30 the user may enter the data using keypad 330, in which case dialpad program 525 interprets the input data. Alternatively, the user may input data by touching an on-

screen keyboard 822. Also, the user may enter data by writing on display 340, which is then interpreted by handwriting recognition program 530. Voice command is another mode of data entry facilitated by state-of-the-art voice recognition technology.

5 Screen 820 (Fig. 8B) shows a blank EBC as it first appears. To assist the user, the blank EBC preferably contains watermark headings for each field. If display 340 cannot display the full screen, program 520 displays scroll buttons 821 and 831 for the user to scroll the display up or down by simply touching scroll buttons 821 and 831. Alternatively, the user may scroll using the hard keys on
10 keypad 330. In screen 820, the user is in the process of entering the name "Bobby Bon" (step 720).

 Screen 830 (Fig. 8C) is the bottom portion of the blank EBC displaying additional user-defined text at the bottom. If the user selects an icon selection button 832, program 520 displays a screen 840 (Fig. 8D) with an icon menu 841
15 containing several predesigned icons for various communication devices and locations, for example, home, cellular, business, facsimile, e-mail, or others. In an embodiment consistent with the present invention, the icons preferably represent some characteristic of the associated telephone number.

 Fig. 9 is a table 900 illustrating certain exemplary icons. Row 910 of table
20 900 shows exemplary icons representing the location or type of communication terminal of the telephone number, *e.g.*, home, office, cellular, or car/mobile. Next, row 920 shows exemplary icons representing the type of communication channel, *e.g.*, e-mail, fax, SMS, or paging. Finally, row 930 shows exemplary custom icons, *e.g.*, special person or group, corporate/business identifiers, or special
25 service.

 As illustrated, icons may present a certain group of people. Custom icons may also represent specialized services or pre-programmed macros. For example, a macro may perform all steps necessary to set up a conference call to a predetermined group of people. One skilled in the art may, however, easily
30 modify the number and the type of icons shown in icon menu 841 and table 900.

The user also has an option of creating a new icon or modifying an existing one under "Others" option of icon menu 841. If the user selects the "Other" option, program 520 initiates icon edit program 535, which opens an icon editing screen 1010 shown in Fig. 10. Icon editing screen 1010 contains an eraser button
5 1011 and a draw button 1012 to create or edit an icon.

In the example icon editing screen 1010, a user has selected to edit an existing home icon. Icon edit program 535 displays the actual size icon in an icon view button 1013 as it would appear in the name list. Icon edit program 535 also provides an enlarged view of the icon in an icon bitmap view 1014. The user may
10 erase or draw in the bits of the icon using eraser button 1011 and draw button 1012.

Alternatively, rather than using erasure button 1011 or draw button 1012, a user may turn on or off each bit of the icon simply by touching each block of icon shown in icon editing screen 1010. In this embodiment, a user may utilize erasure
15 button 1011 and draw button 1012 to erase or draw a large section of the icon.

When the user finishes modifying the icons, the user may select a "Save" icon 1015 to save the modifications. Icon edit program 535 then stores the updated icon in the corresponding icon field of table 600. Program 520 also facilitates the user to add the new icon in icon menu 841 upon user selection. The
20 user may also select to display the new icon in icon selection button 832 associated with a corresponding phone number.

Figs. 11A and 11B show exemplary screens 1110 and 1120, respectively, displaying a completed EBC. In one embodiment consistent with the present invention, the EBC may be stored in memory 440 of mobile telephone 210 or at a
25 central location (step 725). The central location may be a server, which may be connected to a telephone network or a data network.

A user can also create a new EBC using the CLID information transmitted over a telephone network, such as the GSM network. Specifically, if the user's device receives and displays the CLID information, *i.e.*, the phone number of the
30 caller, the user can create a new EBC by transferring the CLID information to the new EBC.

- 13 -

Referring to Fig. 12A, screen 1210 is an exemplary display, consistent with the present invention, of when the user receives a call from a caller. CLID information, "Bobby Bonito" and "738-9157," appears in the name and number fields, respectively. The user, while on the phone with the caller, may select an information icon 1211 to display the EBC associated with the caller. Upon
5 selection, program 520 searches either the name or telephone field of stored EBCs to locate the match. If program 520 finds a match, program 520 displays the corresponding EBC.

If, however, there is no match, screen 1220 (Fig. 12B) presents an option
10 to create a new EBC corresponding to the caller as shown in screen 1220. If the user selects not to create a new EBC, program 520 displays screen 1210 again for the remainder of the call. If the user chooses to create a new EBC for the caller, program 520 presents a blank EBC and automatically transfers the name and telephone numbers included in the CLID to the corresponding fields in the EBC.

For example, screen 1230 (Fig. 12C) illustrates that the caller's name
15 "Bobby Bonito" and telephone number with the appropriate area code is transferred to the appropriate fields of the new EBC. The telephone number is identified as a home number by the associated home icon in the CLID information. Accordingly, program 520 also assigns a home icon with the caller's number. The
20 user may input the remaining information through any input method described above. Thereafter, program 520 stores the EBC as a new entry in table 600.

A new EBC may be created using information manually entered by the user to initiate a call. After the user has manually entered the telephone number of the recipient, the user may select the "Create card" option of action menu 811
25 before initiating the call, during the call, or after the completion of the call. After selecting the "Create card" option, the user may enter other fields for that entry to be stored in table 600.

Once the EBCs have been created and stored, program 520 can present the EBCs to the user as a directory. A user can specify the fields of the EBC to be
30 displayed in the directory by modifying program 520. In an exemplary display

- 14 -

shown in Fig. 13A, screen 1310 displays the EBCs as a name list with corresponding telephone numbers.

Referring to Fig. 14, which is a flowchart of a process for implementing a scrolling feature, a user may view or search the name list by scrolling using
5 screen-based graphical scroll keys or the hard scroll keys on keypad 330. A tap on the scroll key (step 1400) advances the display of the name list incrementally, providing the full name list view in display 340 (step 1405). One skilled in the art may easily vary the amount of advancement in the display. For example, program 520 may advance to the next telephone number with a tap on the scroll key. If the
10 bottom line of display 340 is the last of several telephone numbers associated with a particular name, then program 520 may advance the display to the first telephone number of the next name.

From the full view of the name list, a user may activate a call. To do so, the user simply touches the name or telephone field of the desired entry, which in
15 turn causes program 520 to display the corresponding name and first telephone number with the associated icon in a call object 1311. Program 520 also displays associated information icon 1211 (Fig. 12A) in call object 1311 (Fig. 13A). Information icon 1211, displayed in call object 1311 or within the name list, may be selected to instantly display the EBC associated with the selected information
20 icon 1211 as shown in screen 1320 of Fig. 13B.

To select another one of the several telephone numbers associated with the selected name, a user touches the desired telephone number. Program 520 then displays the selected telephone number in call object 1311. Call object 1311 is in a ready-mode, able to activate the associated object upon user selection. In one
25 embodiment, call object 1311 activates call object program 540, which automatically initiates a call to the telephone number in call object 1311. If the user selects either the name or the telephone number field in call object 1311, program 520 activates call object program 540 to initiate a call.

If the scroll key is pressed and held for a continuous scroll (step 1410),
30 program 520 displays a compressed view of the name list in display 340 (step 1415). In one embodiment of the present invention, the compressed view displays

- 15 -

only the name field of the name list as shown in screen 1510 of Fig. 15A. One skilled in the art may, however, easily modify the fields to be displayed in the compressed view of the name list.

As shown in screen 1510, during the scroll, program 520 displays the first
5 entry in display 340 in a call object 1311. The user may stop scrolling by releasing the scroll key. Upon release (step 1420), program 520 automatically displays a full view of the entries from the compressed view as shown in screen 1520 of Fig. 15B (step 1425).

As mentioned above, a user may initiate a call to the telephone number in
10 call object 1311 by selecting a "Dial" button 1521. If the user wants to select another entry for call object 1311, the user simply selects the name or telephone field of the desired entry from display 340 and program 520 displays the selected entry in call object 1311. Although the automatic compression and expansion feature is described in a telephony setting using mobile telephone 210 for
15 explanatory purposes, one skilled in the art may easily apply this feature in any program or platform.

From the directory, a user may navigate easily between the name list view and the EBC view. From the name list, if the user selects information icon 1211, program 520 displays the EBC view of the entry associated with the selected
20 information icon 1211. The EBC view floats in its own window over top of any existing displays. The user may return to the name list view by selecting a "Close" icon 1321.

While screen 1310 is displayed, a user may edit the entries of the directory using any one of the input methods discussed above. If the user selects
25 information icon 1211, program 520 displays the EBC in full view. At this point, the user may add or edit any field of the EBC. The EBC floats on top of any currently running application and does not require the user to exit current application to launch a separate application to edit the EBC. Program 520 updates the stored EBC with the edits in the corresponding fields in table 600.

30 A user may also locate a particular entry of the name list without scrolling through each entry. Specifically, the user inputs a search text, for example, a

- 16 -

specific name or keyword, and program 520 searches the fields of EBCs in table 600. The present invention employs an incremental search algorithm to make the search easier for the user. For example, if user enters the letter "M" of "Mike," program 520 will display the portion of the directory with names starting with the letter "M." A particular icon may also be used as a search criteria. Once program 520 locates the desired EBC, it displays the portion of the name list corresponding to the located entry.

As previously mentioned, CLID information is stored at a telephone network and includes names and telephone numbers. Referring to Fig. 16, in one embodiment consistent with the present invention, the telephone network may also store icons associated with the telephone numbers (step 1600). In one implementation consistent with the present invention, telephone networks may receive location icons from individual subscribers and store the icons with the associated telephone numbers. For a private telephone switch, there may be a uniform location icon for all telephone numbers within the private switch. One example is a large corporation having a private switch and associating all telephone numbers of the corporation with a corporate location icon.

When a call is initiated (step 1605), the telephone network transmits the CLID information (step 1610). Shortly thereafter, the telephone network also transmits any USSD, such as a location icon (step 1615).

Once a call is transmitted to the receiver's mobile telephone 210, program 520 searches table 600 for an entry corresponding to the telephone number included in the CLID (step 1620). If there is a match (step 1625), then program 520 displays the CLID information with the icon associated with the transmitted telephone number from table 600 (step 1630).

If there is no match in table 600 (step 1625), then program 520 displays the CLID information with the transmitted icon in display 340 (step 1635). As described above in connection with Figs. 12A-12C, program 520 presents an option to create an EBC using the transmitted CLID information and the associated icon (step 1640).

The location icon provides visual assistance to the receiver in quickly determining the location or the type of device of the caller. Additionally, if the caller's device can display graphical images, the telephone network transmits the recipient's CLID information including the associated icon. There are efforts to
5 develop standards and designing systems for capturing and transmitting GPS (Global Positioning System) protocol. The present invention is well suited to incorporate such a feature. For example, the user may be presented with more precise GPS information about the caller's location by touching the location icon.

USSD is transmitted with a call from a caller or a non-ringing call from the
10 switch over the telephone network. A non-ringing call from the switch occurs when the user's device is turned on and communication takes place between the telephone network and the device for standard maintenance transactions such as determining the location of the device or updating the program on the user's device for a subscriber feature. The transmitted information may be sent as a data packet
15 of approximately 140 bytes. There are typically two possible times for transmitting USSD with respect to the timing of a call. It may be transmitted either shortly after the CLID information transfer but before user pick up, or after the completion of the call. USSD may be transmitted, however, at other times.

The user can also send and receive an EBC to another user over the GSM
20 network. The transmitted EBC may contain the data shown in table 600. The EBC may be transmitted as an SMS text message in a similar environment as described above in connection with CLID and associated icons. Alternatively, EBCs may be stored at a central server accessible by any third party from which third party users may download the EBCs. The EBCs stored at the central server
25 might be voluntarily submitted by users wanting to provide public access to their EBC.

To send an EBC to another user, the user selects the "Send Card" option of action menu 811 in Fig. 8. Upon the user's selection, program 520 prompts the
30 user to input the name and phone number of the recipient as well as the name field of the EBC to be sent.

- 18 -

An exemplary display 1710 of Fig. 17A illustrates the user sending an EBC of "Arlan Anderson" to "Bobby Bonito." Upon verifying this information, the user activates the transmission by selecting a "Send" icon 1721 of screen 1720 of Fig. 17B. The user may also abort the send option by selecting a "Quit" icon
5 1722. Alternatively, the user may send an EBC while the user is engaged in a voice call with the recipient or a third party.

The user can also receive an EBC from another user regardless of whether the user is engaged in a voice call. When mobile telephone 210 receives an EBC, program 520 displays the source of the EBC and the EBC itself as shown in screen
10 1810 of Fig. 18A. In this sample display, "Colin Smith" is engaged in a voice call with the user. "Colin Smith" has also sent an EBC of "Bobby Bonito" to the user, who has an option to select any one of "Save" icon 1811, "Discard" icon 1812, or "Quit" icon 1813.

If the user selects "Save" icon 1811, program 520 automatically
15 incorporates the fields of the received EBC into the corresponding fields of a new EBC in table 600. For example, "Bobby Bonito" is automatically saved in the name field of the new EBC. After program 520 saves the new EBC in either memory 440 or at a central location, program 520 displays a name list view of the new entry as shown in screen 1820 of Fig. 18B.

In addition to incorporating the CLID information in the directory, CLID
20 information may also be used in various application programs. Specifically, when CLID information of the caller is displayed in mobile telephone 210 of the user, the user may incorporate the CLID information to launch other programs. Fig. 19 is a flow chart of a process for a drag-and-drop feature. First, the user drags the
25 call object containing the CLID information over to a desired application icon using a mouse, a finger, a stylus or other selection and pointing devices (step 1900).

Fig. 20A shows a screen 2010 and the user selecting call object 2011
30 containing CLID information by touching anywhere in call object 2011 except one of the optional buttons, *e.g.*, Hold and Hang Up. While maintaining pressure on call object 2011, if the user starts to drag call object 2011, program 520 minimizes

- 19 -

call object 2011 as shown in screen 2020 of Fig. 20B (step 1905). Minimizing the size of call object 2011 enables the user to move around and position call object 2011 onto the desired program icon.

After the minimized call object 2011 is graphically overlaid on the desired
5 program icon, the user releases the pressure on call object 2011 (step 1910).
Thereafter, program 520 launches the program associated with the program icon
(step 1925). The launched program then incorporates the CLID information into
appropriate fields in the launched program (step 1930).

This drag-and-drop feature automatically transferring CLID information
10 for use in another program is useful in many settings. For example, a reservation
desk at a hotel receives a call from a customer. The hotel, upon receiving the call,
has the customer's CLID information displayed in mobile telephone 210. If the
customer requests a reservation for a room, the hotel clerk can drag call object
2011 onto a calendar reservation program as shown in screen 2110 of Fig. 21A.

15 Upon release of minimized call object 2011, program 520 initiates the
calendar reservation program and the reservation program incorporates the CLID
information into name and telephone number fields of the reservation form as
shown in screen 2120 of Fig. 21B. As mentioned above, the drag-and-drop
feature may launch any program.

20 The programs to be launched are pre-programmed to transfer the CLID
information automatically into appropriate fields in the launched program.
Therefore, a user may pre-program any program likely to utilize the CLID
information to accommodate the drag-and-drop feature. If the user mistakenly
drags-and-drops call object 2011 onto a program icon that has not been pre-
25 programmed (step 1915), program 520 displays an error message or simply
displays screen 2010 (step 1920).

The drag-and-drop feature saves time and increases accuracy of the
information by eliminating the need for the clerk to solicit and type in the name
and telephone number information manually. Once the clerk verifies the CLID
30 information is that of the caller, the CLID information may be automatically
incorporated into a desired program.

There are occasions where the identity or the location of the caller does not correspond to the CLID information. For example, if the registered name of a household phone is "John Wilson" and "Alice Wilson" calls from that phone for a reservation, only the telephone number would be correct. Similarly, some callers
5 may be calling from a different residence, public phone, or an office phone. When only part of CLID information corresponds to the caller, the hotel clerk, in the example, only needs to obtain and enter the incorrect field. If neither field corresponds to the caller, both the name and telephone numbers are entered manually.

10 The drag-and-drop feature is particularly useful in environments where only one person uses a telephone number. For example, wireless telephone is likely to be used by only one person and provides a desirable forum for implementing the drag-and-drop feature. The same holds true for desktop telephones.

15 CONCLUSION

The system and method consistent with the present invention provide a graphical icon identifying the caller's identity and the location of the call. It also facilitates the manipulation of the CLID information to offer enhanced user interfaces such as EBC and drag-and-drop. Additionally, the present invention
20 improves searching and display of a directory, for example, by automatic compression and expansion of the directory during scrolling.

It will be apparent to those skilled in the art that various modifications and variations can be made in the system of the present invention and in construction of this system without departing from the scope or spirit of the invention. Other
25 embodiments of the invention will be apparent to those skilled in the art from consideration of the specification and practice of the invention disclosed herein. The specification and examples should be considered as exemplary only, with the true scope and spirit of the invention indicated by the following claims.

WHAT IS CLAIMED IS:

1. A method of managing information display by compressing an amount of information displayed, the method comprising the steps of:
storing in a memory a directory of entries each including a plurality of
5 fields;
displaying the directory;
activating a scrolling mechanism to scroll the entries of the directory;
displaying a selected one of the fields of the entries when the scrolling
mechanism is activated;
10 receiving a user input releasing the scrolling mechanism; and
displaying other ones of the fields associated with the entries when the
scrolling mechanism is released.
2. The method of claim 1, further including the step of
15 associating one of the fields of the entries with an icon representing the
characteristics of that field.
3. The method of claim 2, further including the step of
receiving a user input selecting the particular entry by activating the
20 associated icon.
4. The method of claim 2, further including the step of
displaying the fields associated with the icon in the form of a business
card.
25
5. The method of claim 1, wherein the storing step includes the substep of
storing in the memory the directory of entries each including a plurality of
telephone numbers and associated information.

- 22 -

6. The method of claim 1, wherein the storing step further includes the substep of
storing the directory in the memory of a communication device.
- 5 7. The method of claim 1, wherein the storing step further includes the substep of
storing the directory in the memory of a central computer.
8. The method of claim 1, further including the steps of
10 receiving a user input selecting one of the displayed entries, and
initiating a call automatically to a telephone number associated with the selected entry.
9. The method of claim 1, wherein the storing step includes the substep of
15 storing in the memory the directory of entries each including a telephone
number and associated information for a GSM network.
10. A system for managing information display by compressing an amount of
information displayed, comprising:
20 a database for storing a directory of entries each including a plurality of
fields;
displaying means for displaying the directory;
means for activating a scrolling mechanism to scroll the entries of the
directory;
25 first means for displaying a selected one of the fields of the entries when
the scrolling mechanism is activated;
means for receiving a user input releasing the scrolling mechanism; and
second means for displaying other ones of the fields associated with the
entries when the scrolling mechanism is released.

30

- 23 -

11. The system of claim 10, further including
means for associating one of the fields of the entries with an icon
representing the characteristics of that field.
- 5 12. The system of claim 11, further including
means for receiving a user input selecting the particular entry by activating
the associated icon.
13. The system of claim 11, further including
10 means for displaying the fields associated with the icon in the form of a
business card.
14. The system of claim 10, wherein the database includes
a database for storing the directory of entries each including a plurality of
15 telephone numbers and associated information.
15. The system of claim 10, wherein the database is in the memory of a
communication device.
- 20 16. The system of claim 10, wherein the database is in the memory of a central
computer.
17. The system of claim 10, further including
means for receiving a user input selecting one of the displayed entries, and
25 means for initiating a call automatically to a telephone number associated
with the selected entry.
18. The system of claim 10, wherein the database includes
a database storing the directory of entries each including a telephone
30 number and associated information for a GSM network.

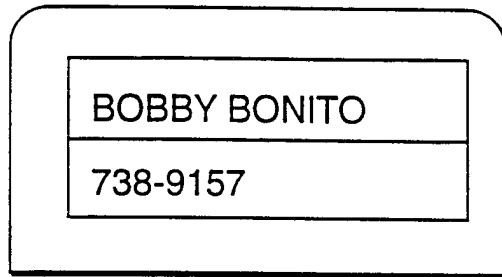


FIG. 1
PRIOR ART

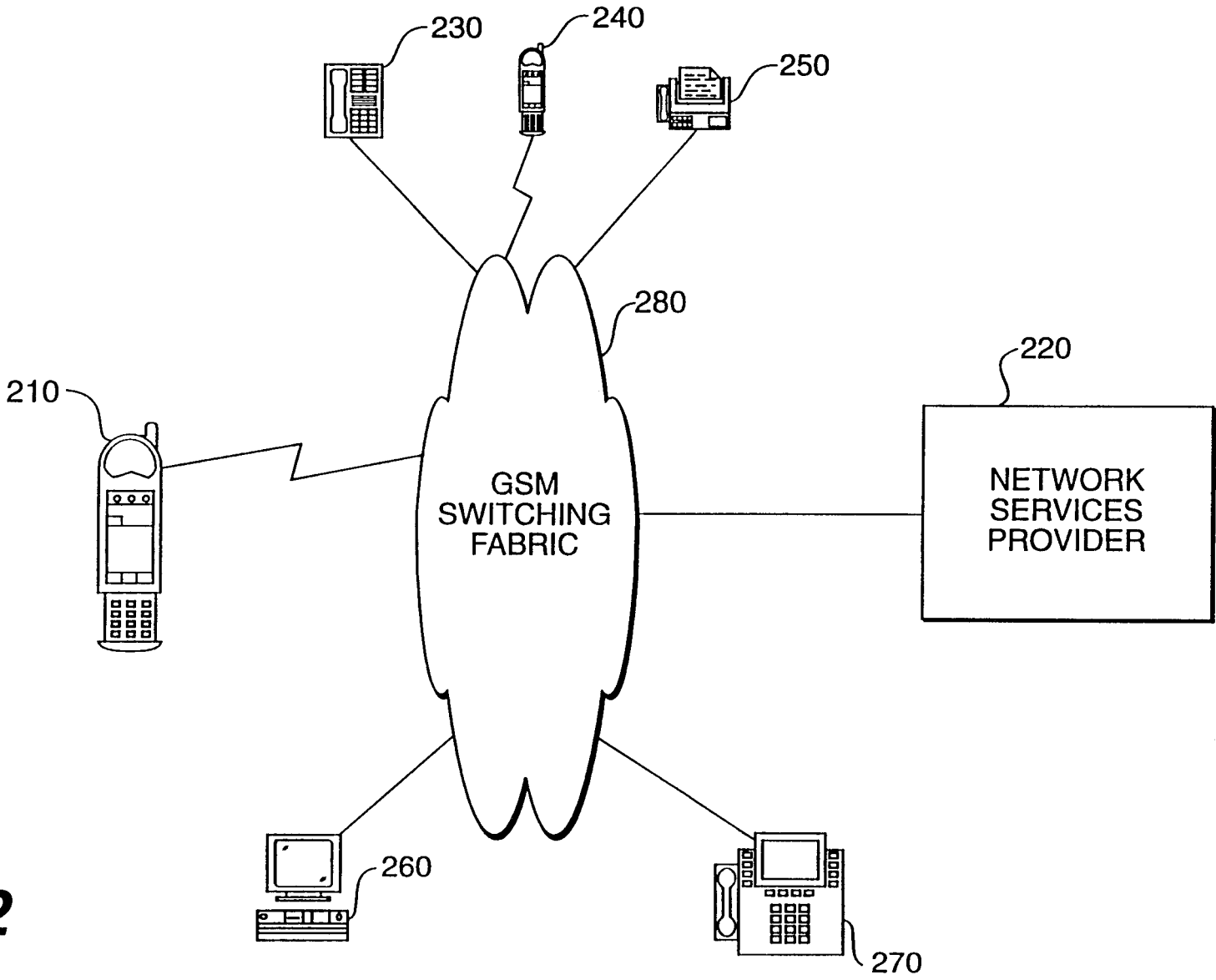


FIG. 2

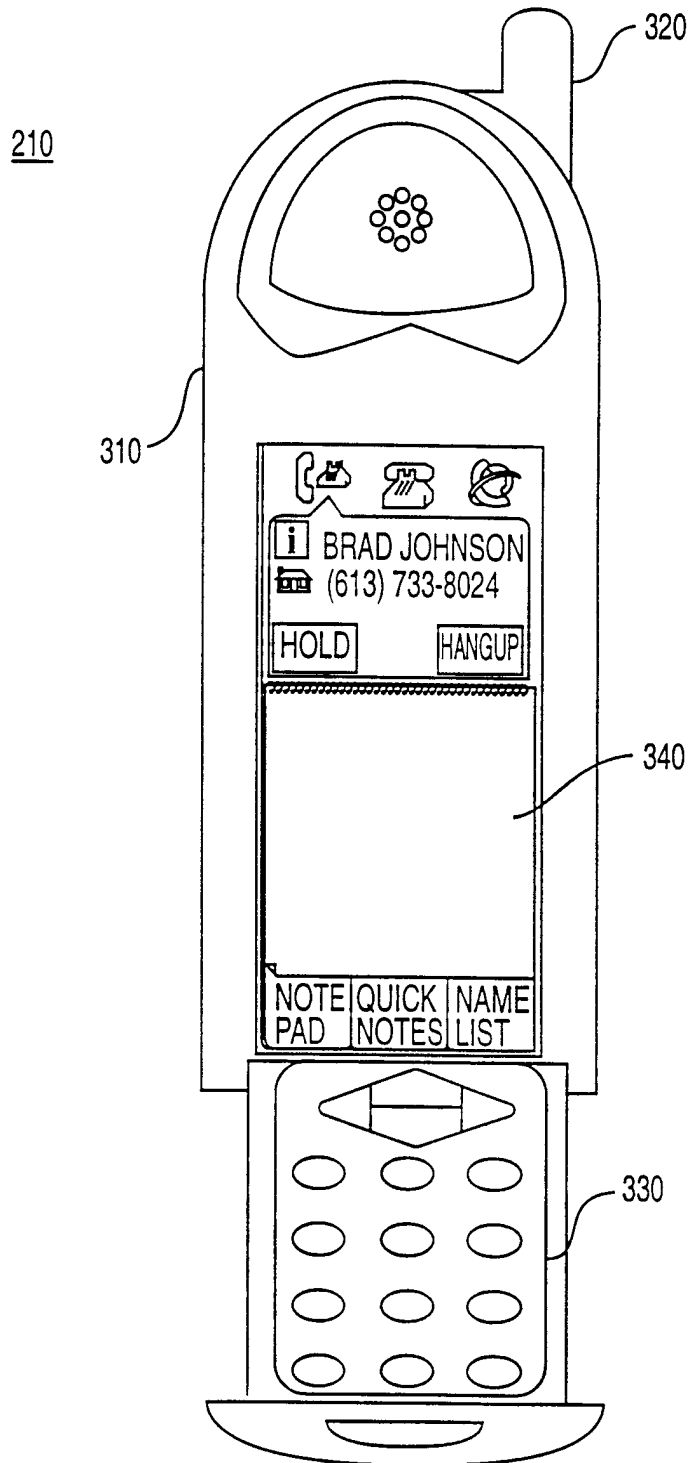


FIG. 3

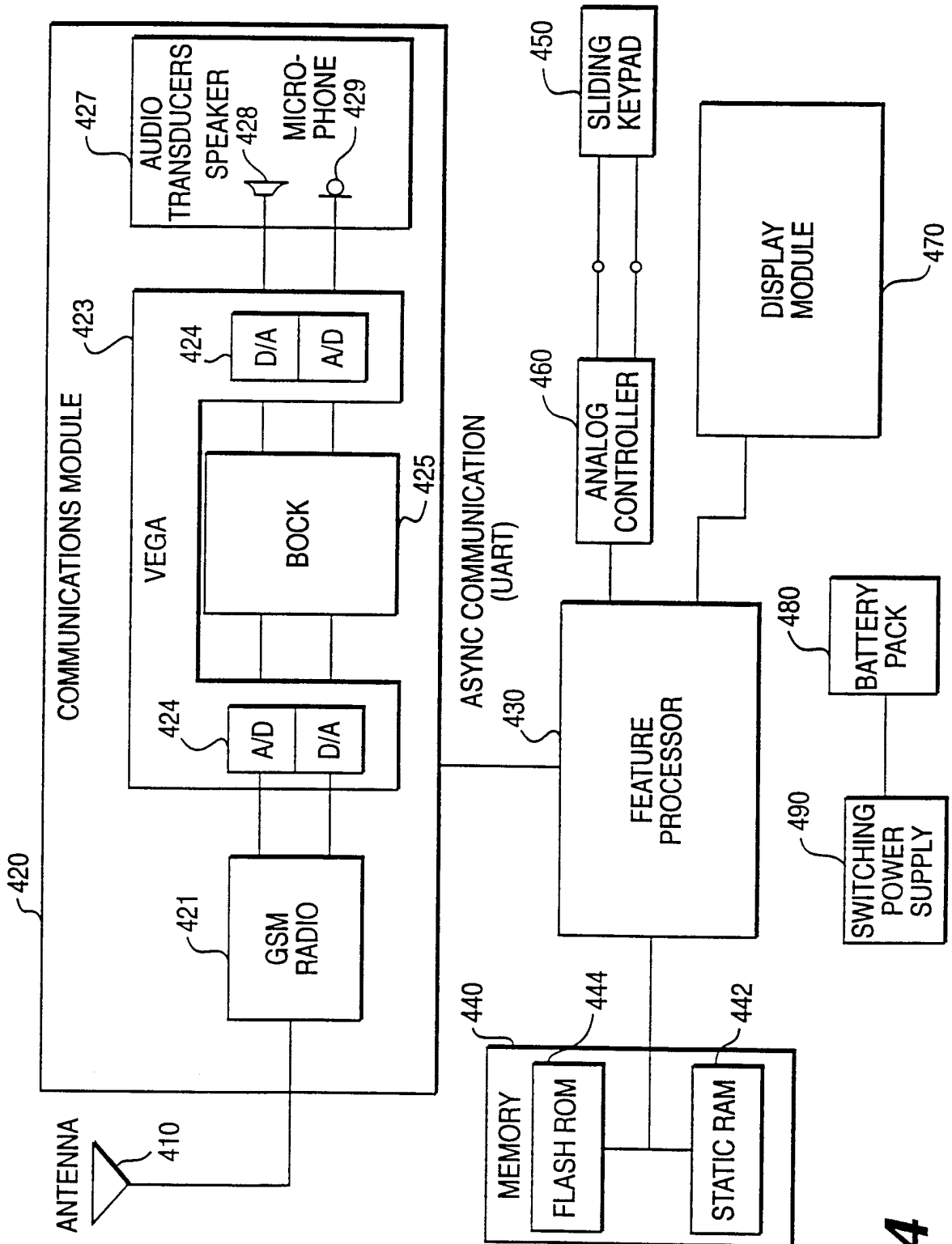


FIG. 4

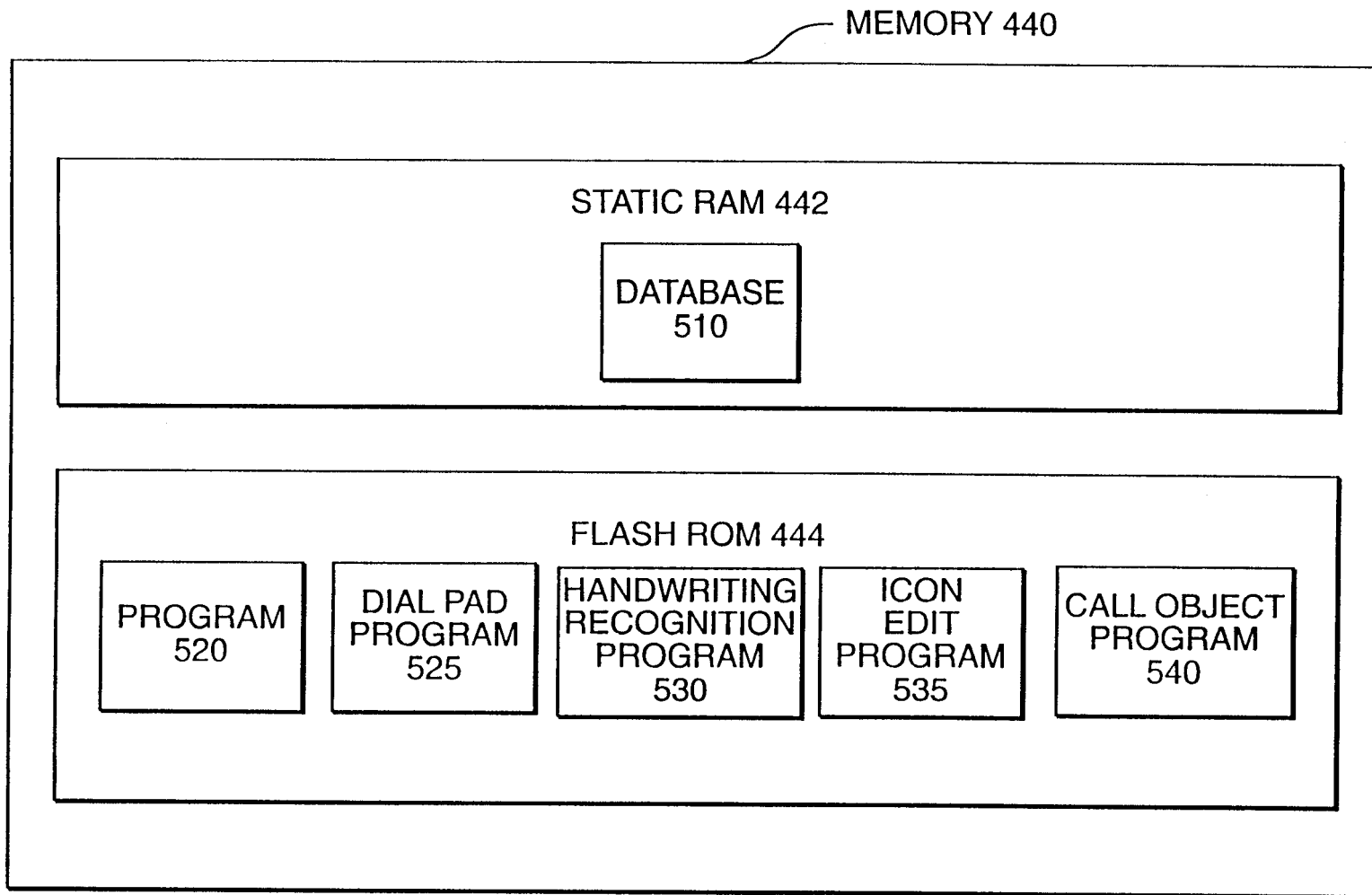







FIG. 5

SUBSTITUTE SHEET (RULE 26)

NAME	TITLE	ORGANIZATION	ADDRESS	COMMUNICATION ADDRESS	ICONS	MISC
NAME A	PRESIDENT	ABC CORP.	123 ABC DR. SOMEWHERE, CA 90210	(613)543-9999	(HOME) 	19 1/2 SHIRT SIZE B-DAY 1-2-34
				(613)789-4356	(WORK) 	
				(613)555-3496	(CELLULAR) 	
				NAME@CA	(EMAIL) 	
				(613)789-4357	(FAX) 	
NAME B						
NAME Z						

6 / 21

FIG. 6

7 / 21

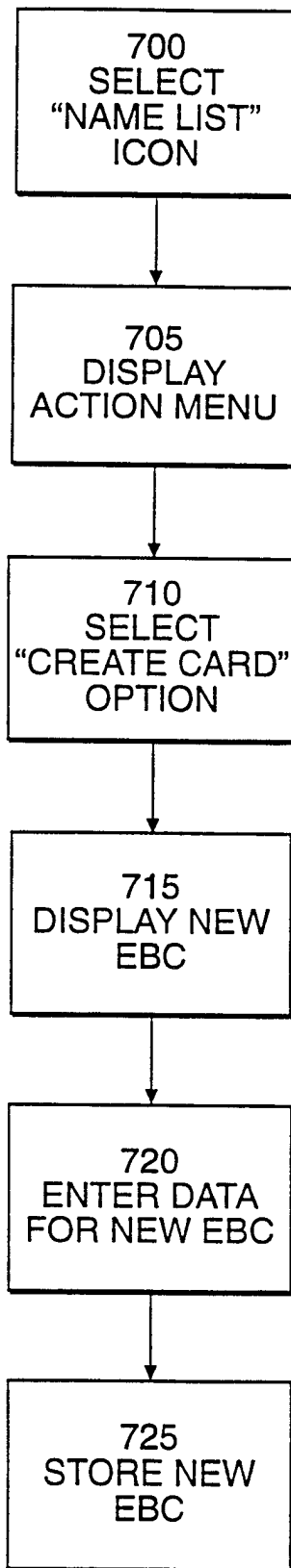


FIG. 7

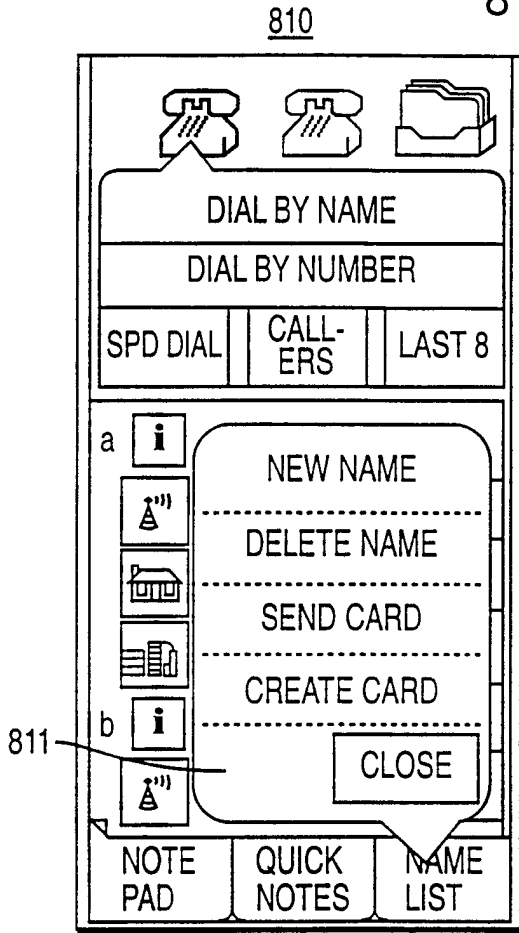


FIG. 8A

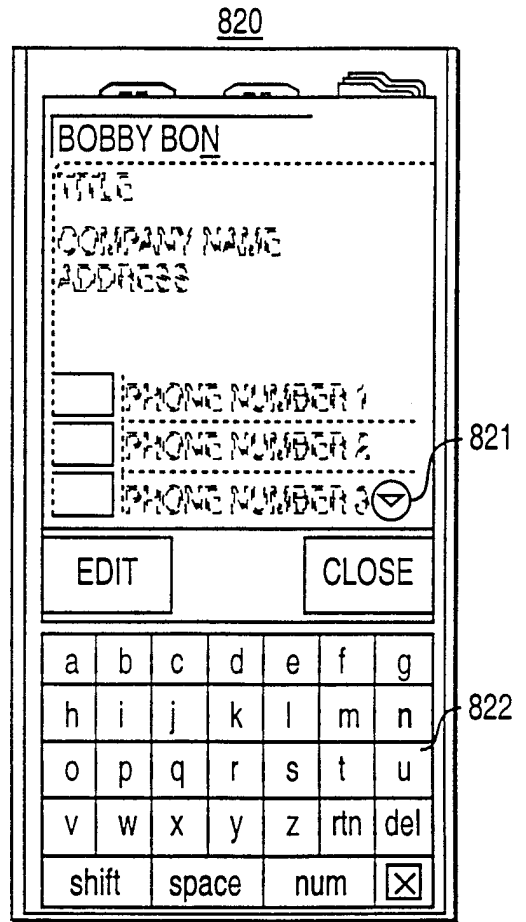


FIG. 8B

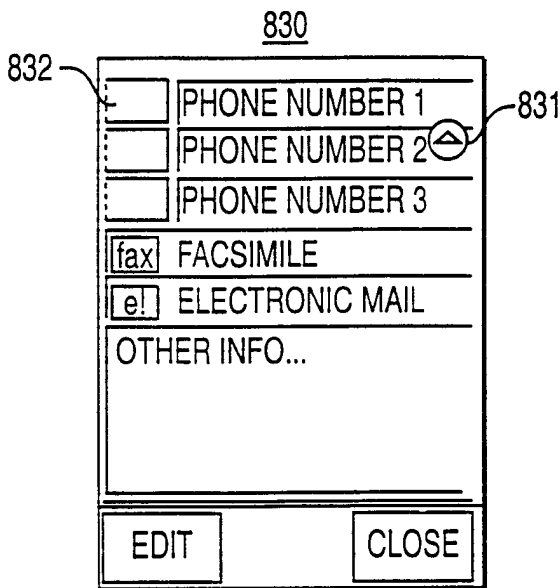


FIG. 8C

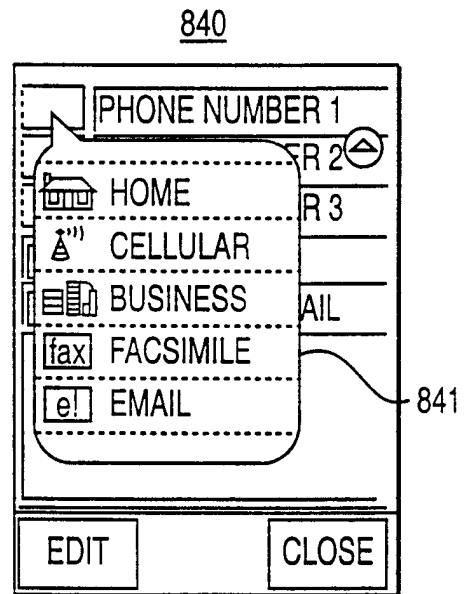


FIG. 8D

9 / 21







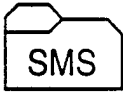



910 LOCATION/TYPE OF COMMUNICATION CHANNEL	(HOME) 
	(OFFICE) 
	(CELLULAR) 
	(CAR/ MOBILE) 
920 TYPE OF COMMUNICATION CHANNEL	(EMAIL) 
	(FAX) 
	(SMS) 
	(PAGING) 
930 CUSTOMIZED ICONS	(SPECIAL PERSON OR GROUP) 
	(CORPORATE/ BUSINESS IDENTIFIERS)
	(SPECIAL SERVICE (CONFERENCE CALL)) 

FIG. 9

10 / 21

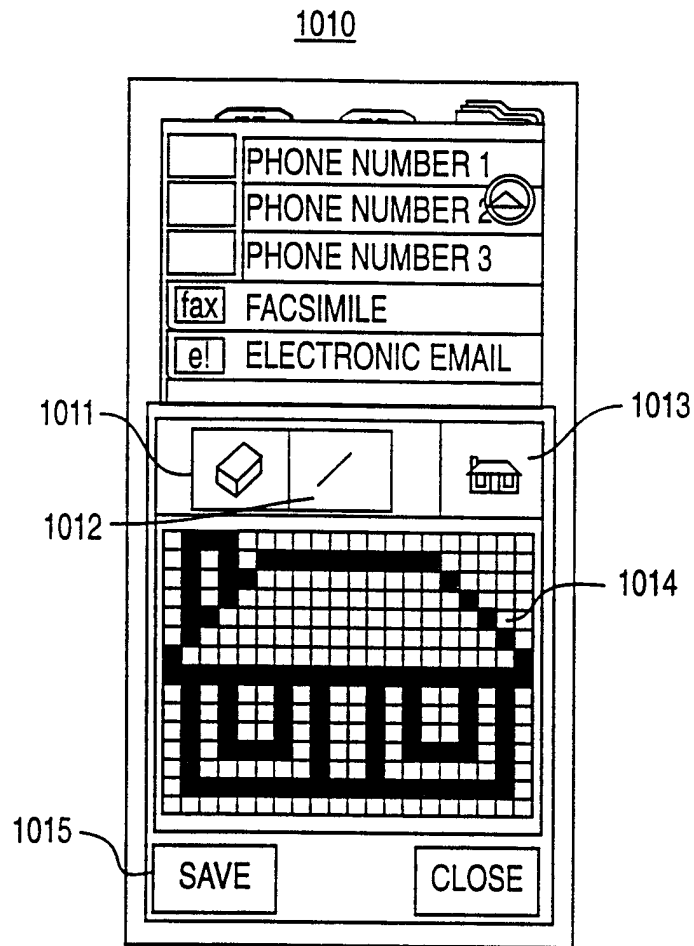


FIG. 10

1110

ARLAN ANDERSON	
TECHNICAL ADVISOR	▲
USA INC. 25 BORDER ST. BORDERTOWN, ON UOS 0A1	
🏠 (613)763-6073	
📞 (613)592-3781	
📠 (613)599-1278	▼
EDIT	CLOSE

1120

ARLAN ANDERSON	
🏠 (613)763-6073	▲
📞 (613)592-3781	
📠 (613)599-1278	
📠 (613)724-5685	
✉ AND@USA.RICH.COM	
JUNE 11 BIRTHDAY 19 1/2 SHIRTSIZE	
EDIT	CLOSE

FIG. 11A

FIG. 11B

1210

📞 📠 📁		
1211	i BOBBY BONITO	
	🏠 738-9157	
HOLD		HANG UP
~~~~~		
NOTE PAD	QUICK NOTES	NAME LIST

**FIG. 12A**

1220

1220

BOBBY BONITO

738-9157

HOLD HANG UP

NO ENTRY FOR THIS CALLER

CREATE CARD FOR BOBBY BONITO?

YES NO

CLOSE

**FIG. 12B**

1230

1230

BOBBY BONITO

738-9157

HOLD HANG UP

BOBBY BONITO

TITLE

COMPANY NAME

ADDRESS

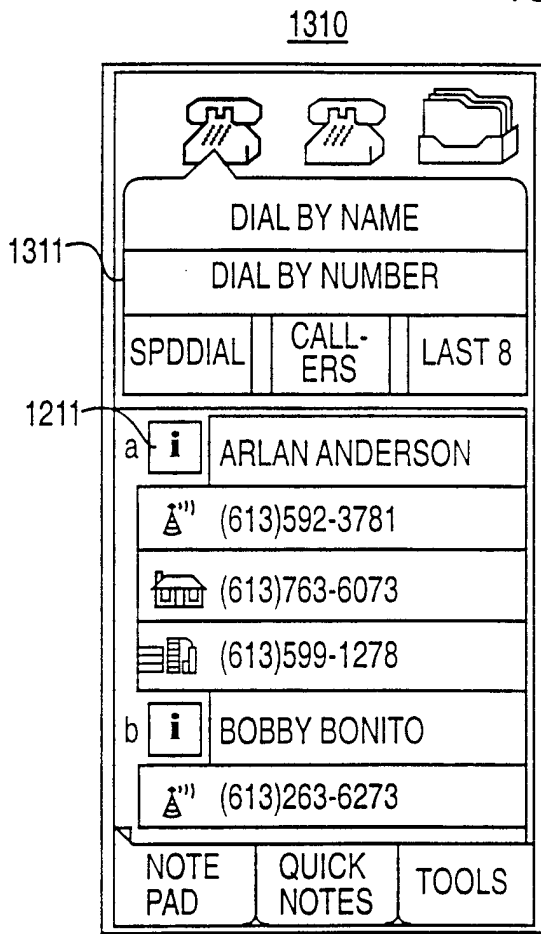
(613)738-9157

PHONE NUMBER 2

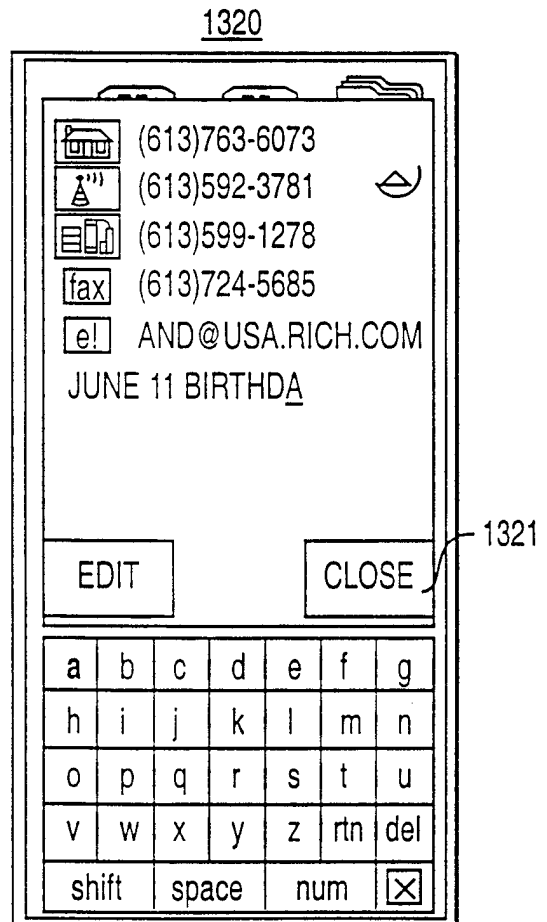
PHONE NUMBER 3

EDIT CLOSE

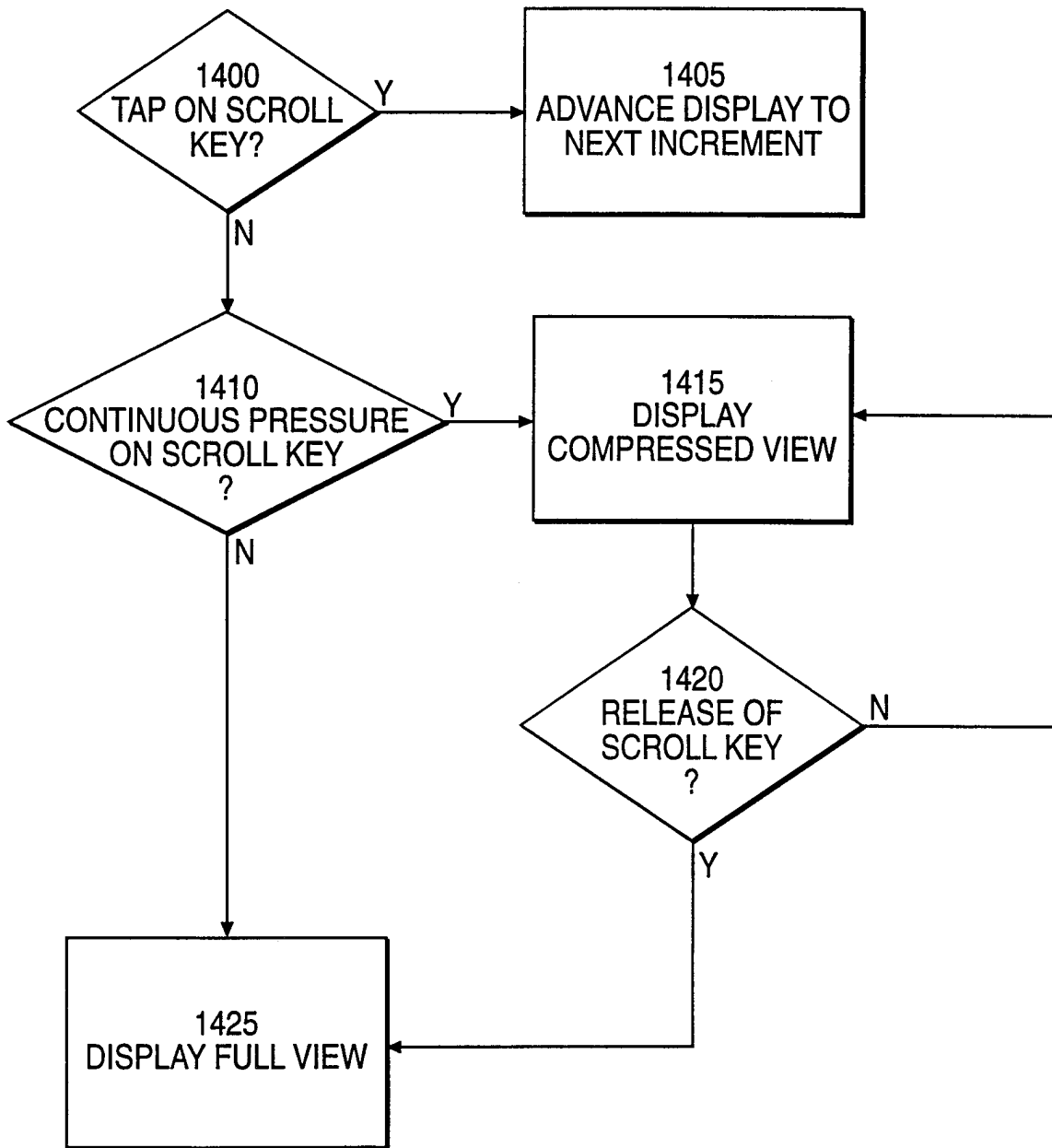
**FIG. 12C**



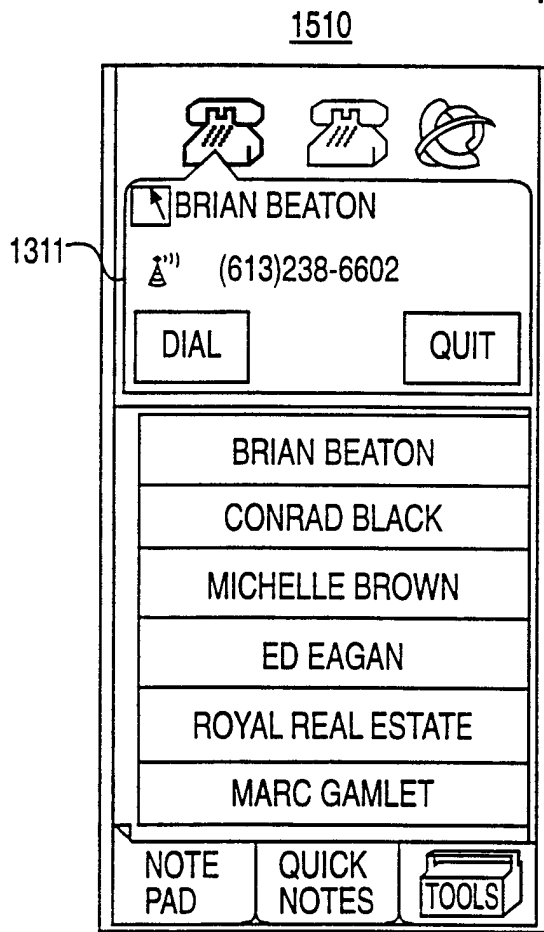
**FIG. 13A**



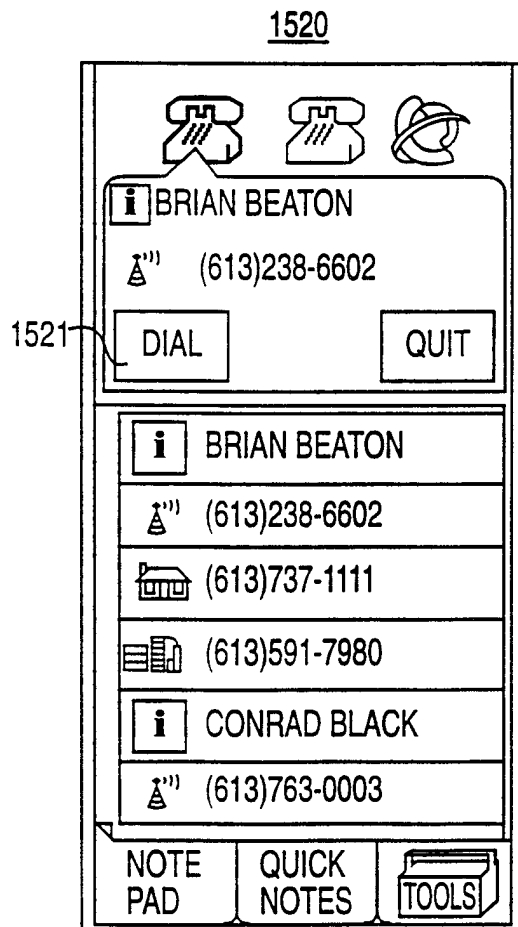
**FIG. 13B**



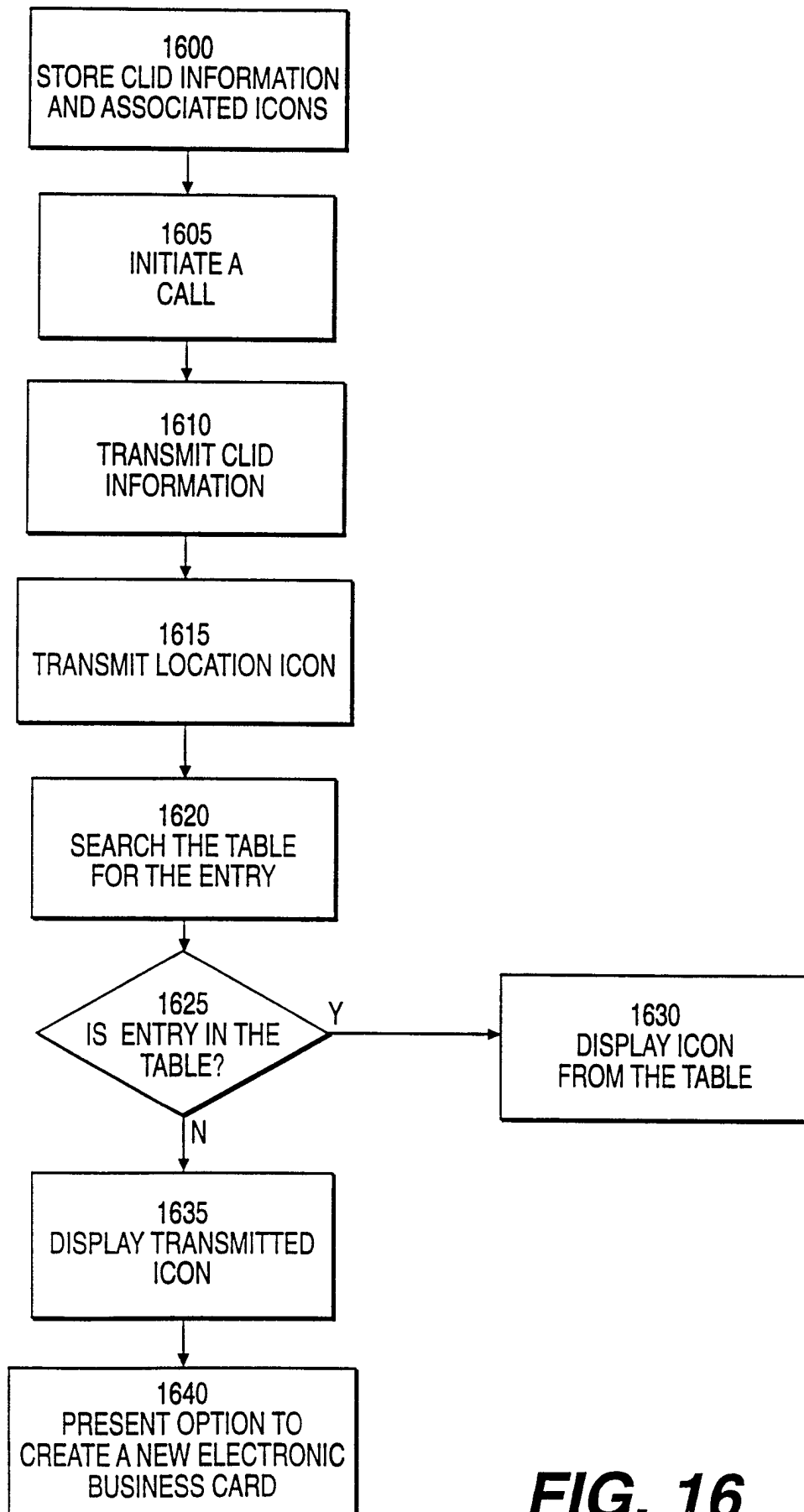
**FIG. 14**



**FIG. 15A**



**FIG. 15B**



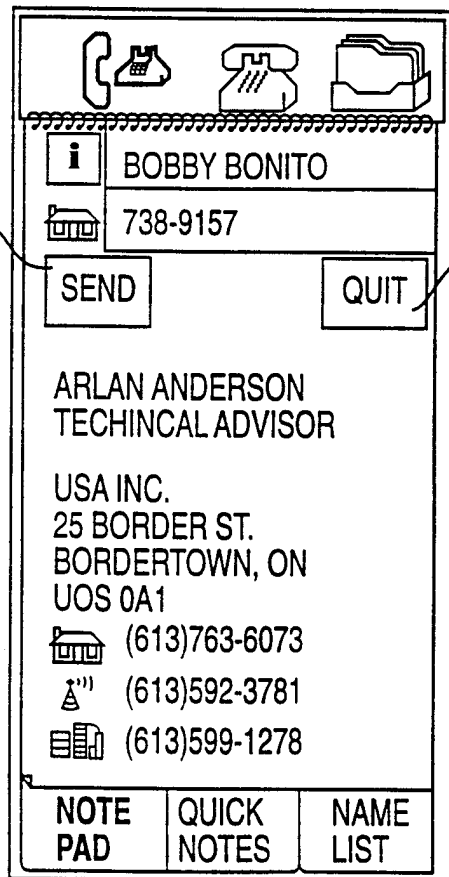
**FIG. 16**

1710



**FIG. 17A**

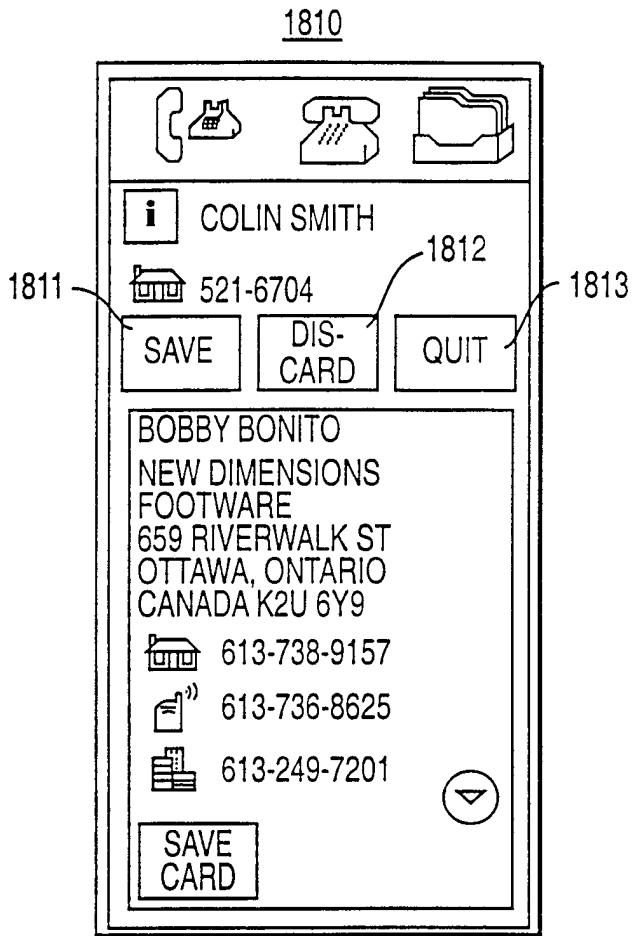
1720



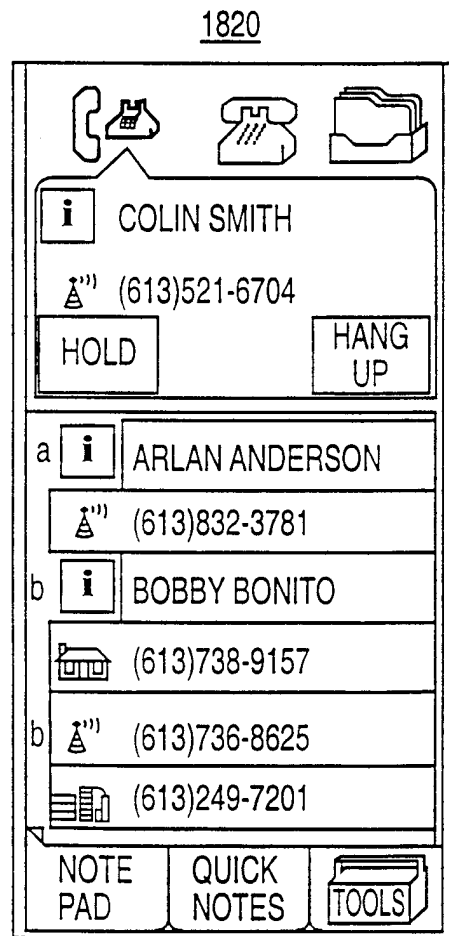
1721

1722

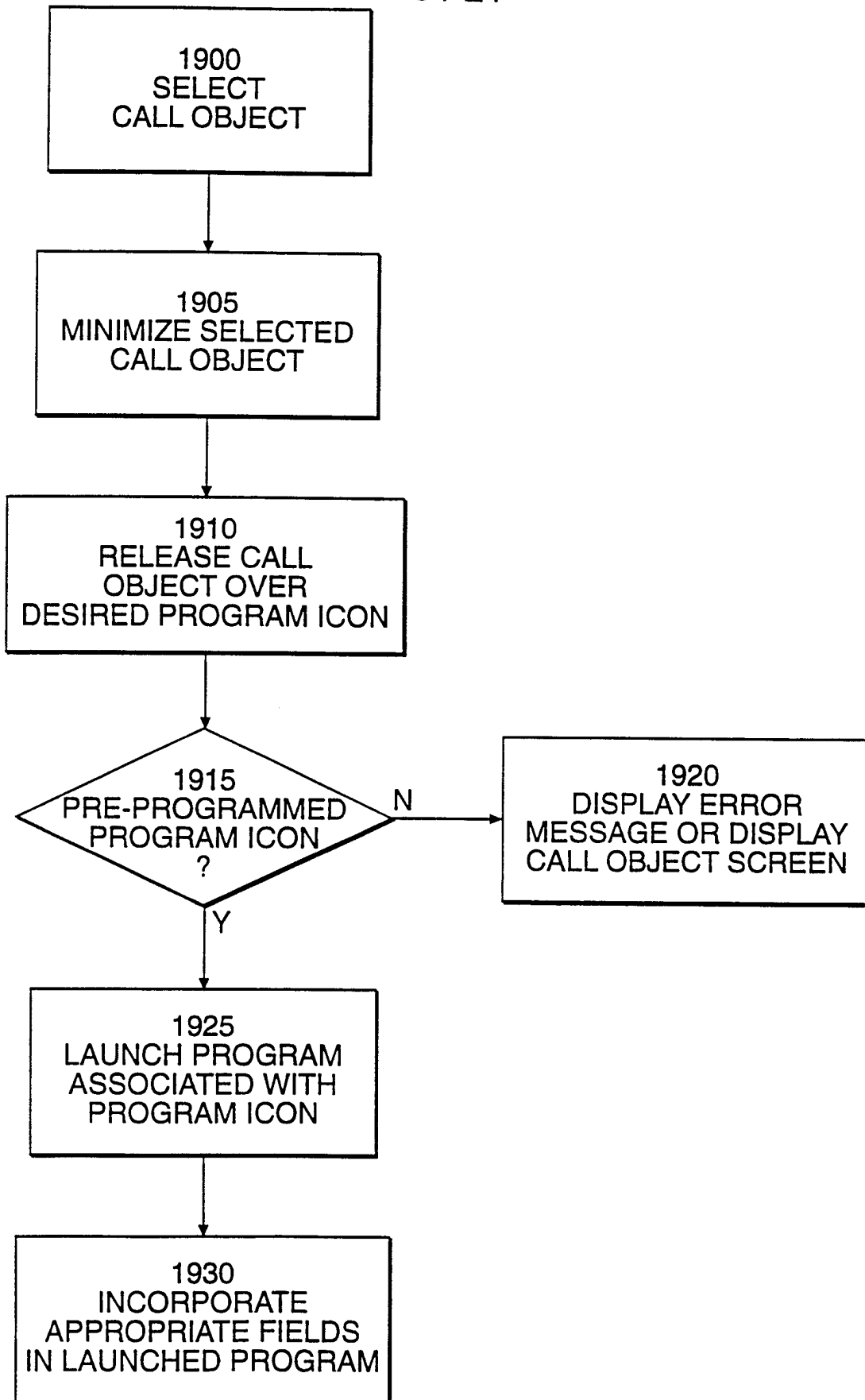
**FIG. 17B**



**FIG. 18A**

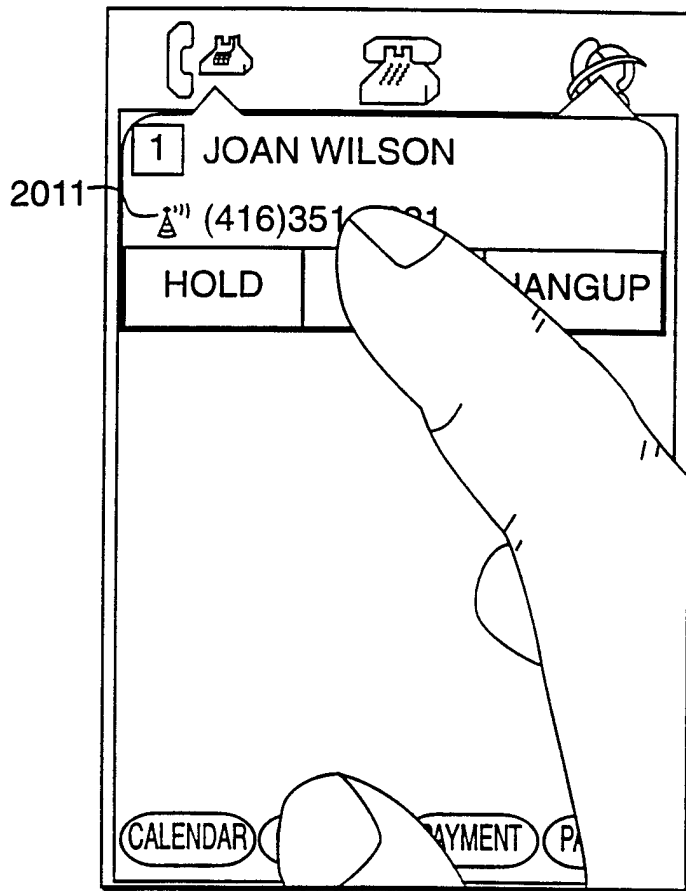


**FIG. 18B**



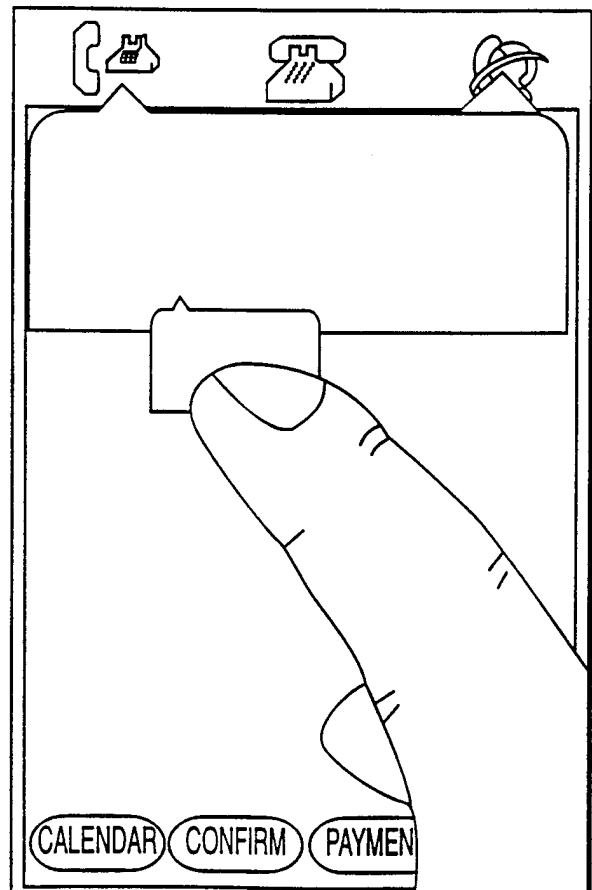
**FIG. 19**

2010 20 / 21



**FIG. 20A**

2020



**FIG. 20B**

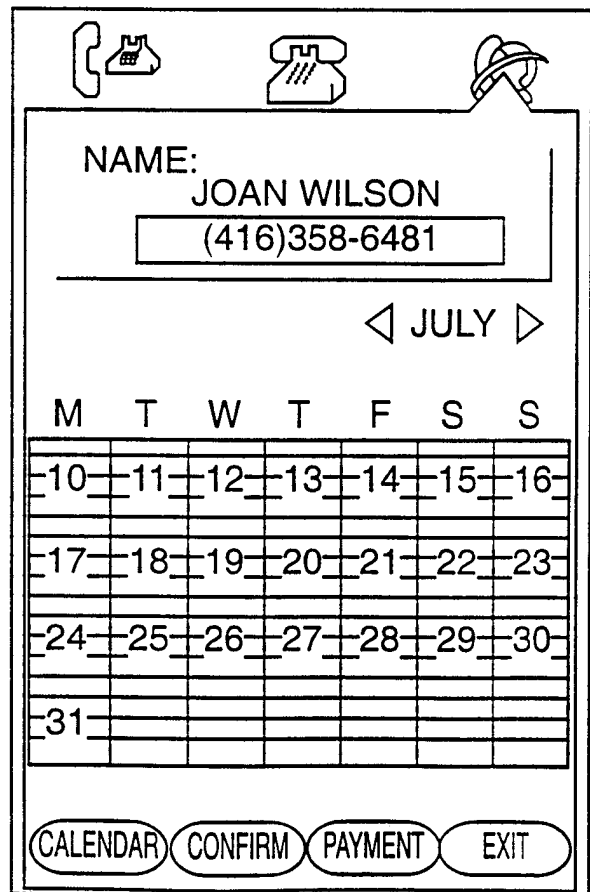
2110

21 / 21



**FIG. 21A**

2120



**FIG. 21B**

# INTERNATIONAL SEARCH REPORT

National Application No  
PCT/IB 98/00773

**A. CLASSIFICATION OF SUBJECT MATTER**  
IPC 6 H04M1/274 G06F3/023

According to International Patent Classification (IPC) or to both national classification and IPC

**B. FIELDS SEARCHED**

Minimum documentation searched (classification system followed by classification symbols)  
IPC 6 H04M G06F

Documentation searched other than minimum documentation to the extent that such documents are included in the fields searched

Electronic data base consulted during the international search (name of data base and, where practical, search terms used)

**C. DOCUMENTS CONSIDERED TO BE RELEVANT**

Category ^o	Citation of document, with indication, where appropriate, of the relevant passages	Relevant to claim No.
Y	US 5 446 882 A (CAPPS STEPHEN P ET AL) 29 August 1995 see column 1, line 22-33 see column 5, line 68 - column 6, line 13 see column 6, line 40-54 see column 11, line 40 - column 12, line 2 see column 12, line 3-13 see figures 1,3-5,13 ---	1-18
Y	EP 0 726 668 A (SONY CORP) 14 August 1996 see column 1, line 18-50 see column 11, line 33-40 see column 12, line 52 - column 14, line 18 see figures 2,3,9,12,16 --- -/--	1-18

Further documents are listed in the continuation of box C.

Patent family members are listed in annex.

^o Special categories of cited documents :

"A" document defining the general state of the art which is not considered to be of particular relevance

"E" earlier document but published on or after the international filing date

"L" document which may throw doubts on priority claim(s) or which is cited to establish the publication date of another citation or other special reason (as specified)

"O" document referring to an oral disclosure, use, exhibition or other means

"P" document published prior to the international filing date but later than the priority date claimed

"T" later document published after the international filing date or priority date and not in conflict with the application but cited to understand the principle or theory underlying the invention

"X" document of particular relevance; the claimed invention cannot be considered novel or cannot be considered to involve an inventive step when the document is taken alone

"Y" document of particular relevance; the claimed invention cannot be considered to involve an inventive step when the document is combined with one or more other such documents, such combination being obvious to a person skilled in the art.

"&" document member of the same patent family

Date of the actual completion of the international search

2 September 1998

Date of mailing of the international search report

09/09/1998

Name and mailing address of the ISA

European Patent Office, P.B. 5818 Patentlaan 2  
NL - 2280 HV Rijswijk  
Tel. (+31-70) 340-2040, Tx. 31 651 epo nl,  
Fax: (+31-70) 340-3016

Authorized officer

Golzio, D

INTERNATIONAL SEARCH REPORT

national Application No  
PCT/IB 98/00773

C.(Continuation) DOCUMENTS CONSIDERED TO BE RELEVANT		
Category	Citation of document, with indication, where appropriate, of the relevant passages	Relevant to claim No.
Y	<p>WO 96 36927 A (INTEL CORP) 21 November 1996                      see abstract                      see page 6, line 3-15                      see page 9, line 15 - page 10, line 3                      see figures 1-3</p>	<p>2-4,7, 11-13,16</p>
A	<p>-----                      SCHMANDT C ET AL: "PHONETOOL: INTEGRATING TELEPHONES AND WORKSTATIONS" COMMUNICATIONS TECHNOLOGY FOR THE 1990'S AND BEYOND, DALLAS, NOV. 27 - 30, 1989, vol. VOL. 2, no. -, 27 November 1989, pages 970-974, XP000144908                      INSTITUTE OF ELECTRICAL AND ELECTRONICS ENGINEERS                      see paragraph 2.3; figures 3,4</p>	<p>1,10</p>
A	<p>-----                      "ON-LINE DESKTOP ADDRESS BOOK AND AUTO-DIALER"                      IBM TECHNICAL DISCLOSURE BULLETIN, vol. 35, no. 2, 1 July 1992, pages 439-441, XP000313349                      see the whole document</p>	<p>1,10</p>
A	<p>-----                      "SMART ICONS FOR ADDRESS BOOK DETAILED-VIEW ENTRIES"                      IBM TECHNICAL DISCLOSURE BULLETIN, vol. 35, no. 7, 1 December 1992, pages 218-220, XP000332987                      see the whole document</p> <p>-----</p>	<p>1,10</p>

# INTERNATIONAL SEARCH REPORT

Information on patent family members

International Application No  
PCT/IB 98/00773

Patent document cited in search report	Publication date	Patent family member(s)	Publication date
US 5446882 A	29-08-1995	US 5544358 A	06-08-1996
EP 0726668 A	14-08-1996	CN 1136874 A	27-11-1996
		WO 9607262 A	07-03-1996
WO 9636927 A	21-11-1996	AU 5444396 A	29-11-1996
		EP 0826183 A	04-03-1998