



US00D753626S

(12) **United States Design Patent**  
**Tran**

(10) **Patent No.:** **US D753,626 S**

(45) **Date of Patent:** **\*\* Apr. 12, 2016**

- (54) **EARPIECE AUDIO DEVICE**
- (71) Applicant: **MOTOROLA SOLUTIONS, INC.**,  
Schaumburg, IL (US)
- (72) Inventor: **Chi T. Tran**, Weston, FL (US)
- (73) Assignee: **MOTOROLA SOLUTIONS, INC.**,  
Schaumburg, IL (US)
- (\*\*) Term: **14 Years**
- (21) Appl. No.: **29/517,012**
- (22) Filed: **Feb. 9, 2015**

4,977,975 A *	12/1990	Lazzeroni	.....	A42B 3/166
				181/129
5,210,792 A *	5/1993	Kajihara	.....	H04M 1/05
				379/430
D348,067 S *	6/1994	Lucey	.....	D14/223
5,412,736 A *	5/1995	Keliiliki	.....	H04R 1/105
				381/330
D375,313 S *	11/1996	Jensen	.....	D14/206
D375,959 S *	11/1996	Davis	.....	D14/206
5,625,171 A *	4/1997	Marshall	.....	H04R 1/1058
				181/130
D383,757 S *	9/1997	Dobrusskin	.....	D14/223

(Continued)

**Related U.S. Application Data**

- (62) Division of application No. 29/482,622, filed on Feb. 20, 2014, now Pat. No. Des. 726,147.
- (51) **LOC (10) Cl.** ..... **14-01**
- (52) **U.S. Cl.**  
USPC ..... **D14/205**; D14/206
- (58) **Field of Classification Search**  
USPC ..... D14/223, 206, 205; 181/129, 130, 135;  
379/430, 431; 381/380, 381; 455/90.3,  
455/575.1  
CPC ..... H04R 1/10  
See application file for complete search history.

**References Cited**

**U.S. PATENT DOCUMENTS**

2,474,135 A *	6/1949	White	.....	H04R 25/656
				381/330
2,641,327 A *	6/1953	Balmer	.....	H04R 1/105
				181/129
D174,053 S *	2/1955	Norris	.....	455/351
D179,150 S *	11/1956	Norris	.....	D14/192
D180,694 S *	7/1957	Norris	.....	D14/192
4,335,281 A *	6/1982	Scott	.....	H04M 1/105
				381/430
D284,859 S *	7/1986	Okada	.....	D14/192
4,893,344 A *	1/1990	Tragardh	.....	H04M 1/05
				379/430
4,917,504 A *	4/1990	Scott	.....	H04M 1/05
				381/330
D309,306 S *	7/1990	Weiser	.....	D14/249

Primary Examiner — Paula Greene

(57) **CLAIM**

The ornamental design for an earpiece audio device, as shown and described.

**DESCRIPTION**

FIG. 1 is a rear perspective view of an ornamental design for an earpiece audio device in accordance with a first embodiment;

FIG. 2 is a front perspective view thereof;

FIG. 3 is a rear view thereof;

FIG. 4 is a front view thereof;

FIG. 5 is a first side view thereof;

FIG. 6 is a second side view thereof;

FIG. 7 is a top view thereof;

FIG. 8 is a bottom view thereof;

FIG. 9 is a rear perspective view of an ornamental design for an earpiece audio device in accordance with a second embodiment;

FIG. 10 is a front perspective view thereof;

FIG. 11 is a rear view thereof;

FIG. 12 is a front view thereof;

FIG. 13 is a first side view thereof;

FIG. 14 is a second side view thereof;

FIG. 15 is a top view thereof; and,

FIG. 16 is a bottom view thereof.

The broken lines shown in FIGS. 1-16 are included for the purpose of illustrating environmental elements only and form no part of the claimed design.

**1 Claim, 8 Drawing Sheets**

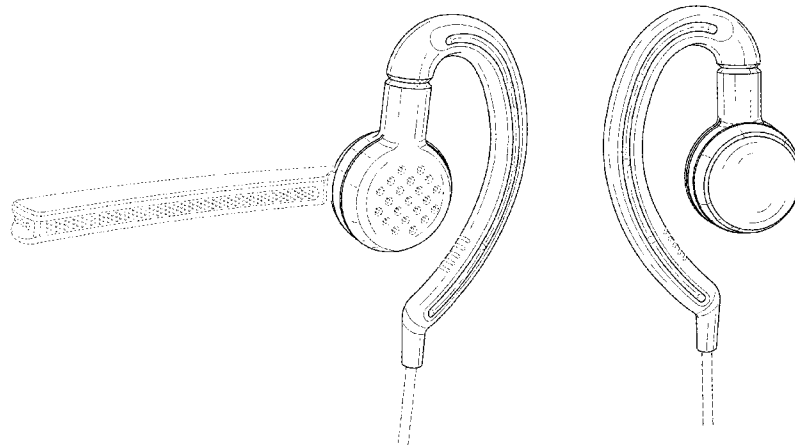

(56)

References Cited

U.S. PATENT DOCUMENTS

5,708,724 A \* 1/1998 Burris ..... H04M 1/105  
 381/370  
 D403,327 S \* 12/1998 Landreth ..... D14/206  
 D407,089 S \* 3/1999 Norin ..... D14/206  
 D420,007 S \* 2/2000 Marshall ..... D14/206  
 D421,755 S \* 3/2000 Pitel ..... D14/223  
 6,101,260 A \* 8/2000 Jensen ..... H04M 1/105  
 379/430  
 D431,030 S \* 9/2000 Yoon ..... D14/142  
 D431,235 S \* 9/2000 Lyman ..... D14/142  
 D441,739 S \* 5/2001 Hayes ..... D14/223  
 D443,261 S \* 6/2001 Yuyama ..... D14/223  
 D451,906 S \* 12/2001 Amae ..... D14/223  
 D451,907 S \* 12/2001 Amae ..... D14/206  
 6,427,018 B1 \* 7/2002 Keliiliki ..... H04R 1/1066  
 381/370  
 D464,943 S \* 10/2002 Lai ..... D14/206  
 D464,944 S \* 10/2002 Lee ..... D14/206  
 D467,908 S \* 12/2002 Bey ..... D14/223  
 D470,128 S \* 2/2003 Hlas ..... D14/205  
 D478,901 S \* 8/2003 Rath ..... D14/223  
 D492,667 S \* 7/2004 Skulley ..... D14/223  
 6,771,790 B2 \* 8/2004 Liu ..... H04M 1/05  
 381/375  
 D500,999 S \* 1/2005 Dyer ..... D14/223  
 D501,196 S \* 1/2005 Dyer ..... D14/205  
 D506,994 S \* 7/2005 Olson ..... D14/205  
 D508,911 S \* 8/2005 Sanders ..... D14/223  
 D510,085 S \* 9/2005 Suzuki ..... D14/223

D510,575 S \* 10/2005 Leong ..... D14/205  
 D518,479 S \* 4/2006 Skulley ..... D14/225  
 7,106,877 B1 \* 9/2006 Linville ..... H04R 1/1066  
 381/370  
 D535,980 S \* 1/2007 Bentley ..... D14/225  
 D541,787 S \* 5/2007 Ma ..... D14/205  
 D543,968 S \* 6/2007 Wong ..... D14/205  
 D575,772 S \* 8/2008 Schultz ..... D14/206  
 D601,126 S \* 9/2009 Christopher ..... D14/206  
 D612,840 S \* 3/2010 Yang ..... D14/206  
 7,708,110 B2 \* 5/2010 Leong ..... A61F 11/08  
 128/867  
 D617,780 S \* 6/2010 Jaakkola ..... D14/223  
 D624,529 S \* 9/2010 Huang ..... D14/206  
 D635,960 S \* 4/2011 Gondo ..... D14/223  
 D645,454 S \* 9/2011 Quek ..... D14/223  
 D653,649 S \* 2/2012 Yang ..... D14/206  
 D657,347 S \* 4/2012 Chung ..... D14/206  
 D671,915 S \* 12/2012 Birger ..... D14/206  
 D681,003 S \* 4/2013 Ham ..... D14/206  
 D681,014 S \* 4/2013 Ham ..... D14/206  
 D684,145 S \* 6/2013 Rath ..... D14/206  
 D691,113 S \* 10/2013 Gougherty ..... D14/206  
 D710,326 S \* 8/2014 Burgett ..... D14/205  
 D717,767 S \* 11/2014 Mistry ..... D14/206  
 D726,147 S \* 4/2015 Tran ..... D14/206  
 2003/0044038 A1 \* 3/2003 Shirata ..... H04R 1/105  
 381/381  
 2005/0286717 A1 \* 12/2005 Viduya ..... H04M 1/05  
 379/430  
 2006/0198544 A1 \* 9/2006 Yueh ..... H04R 1/105  
 381/381

\* cited by examiner

FIG. 1

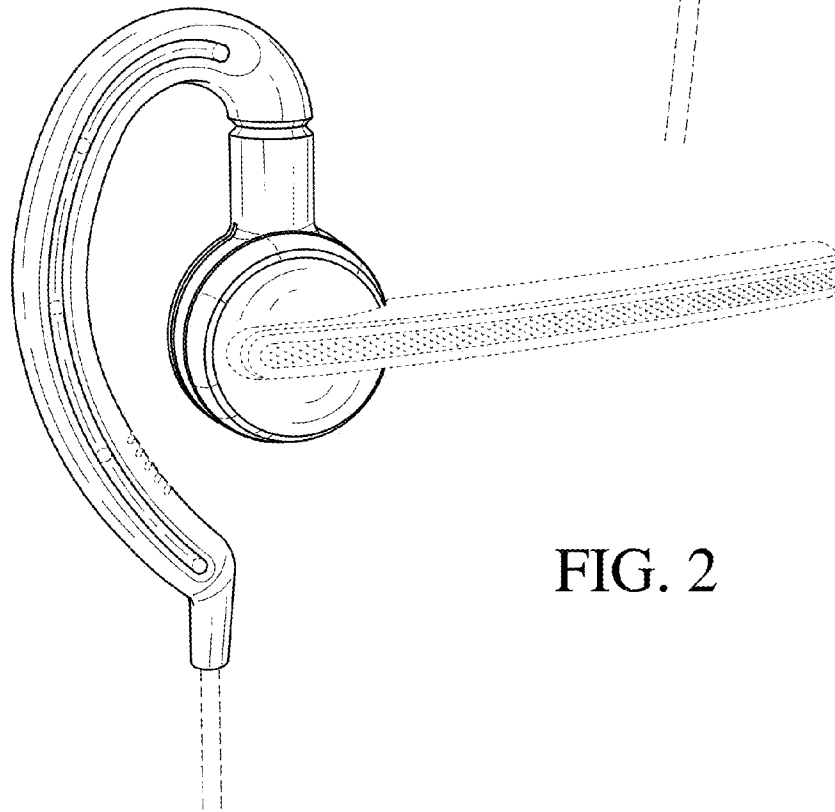
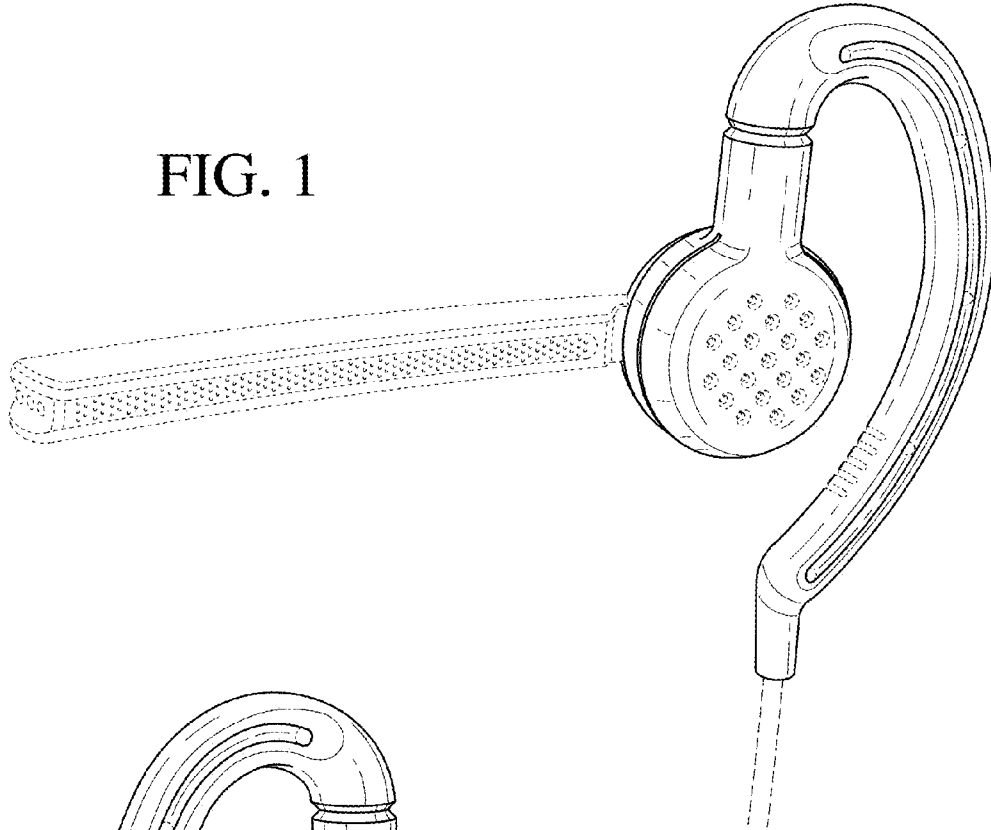

FIG. 2

FIG. 3

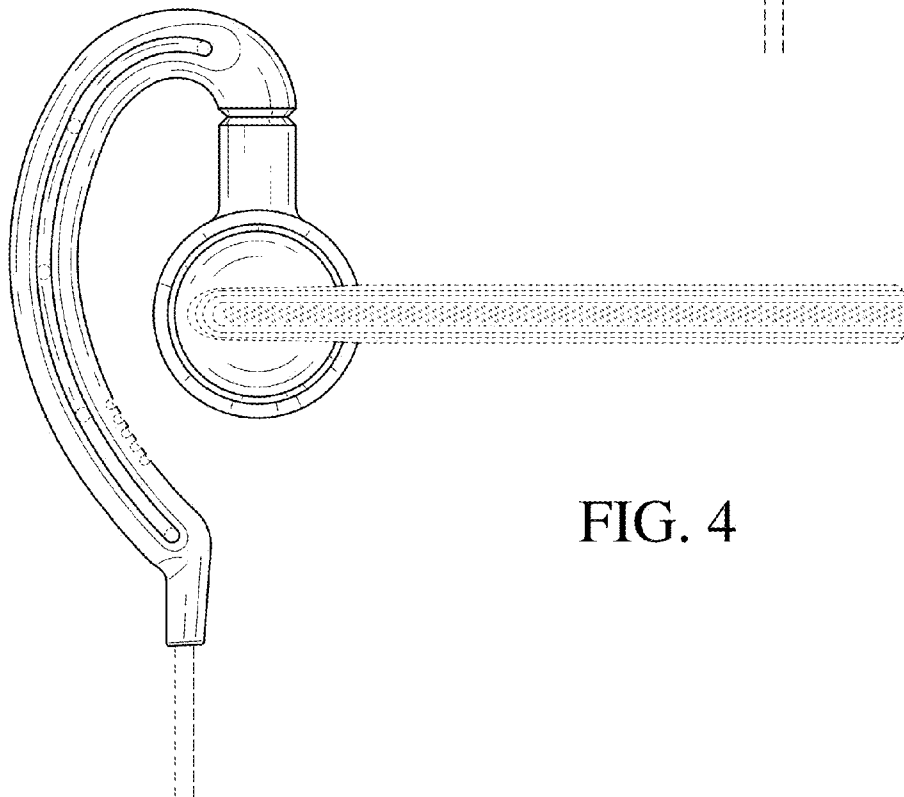
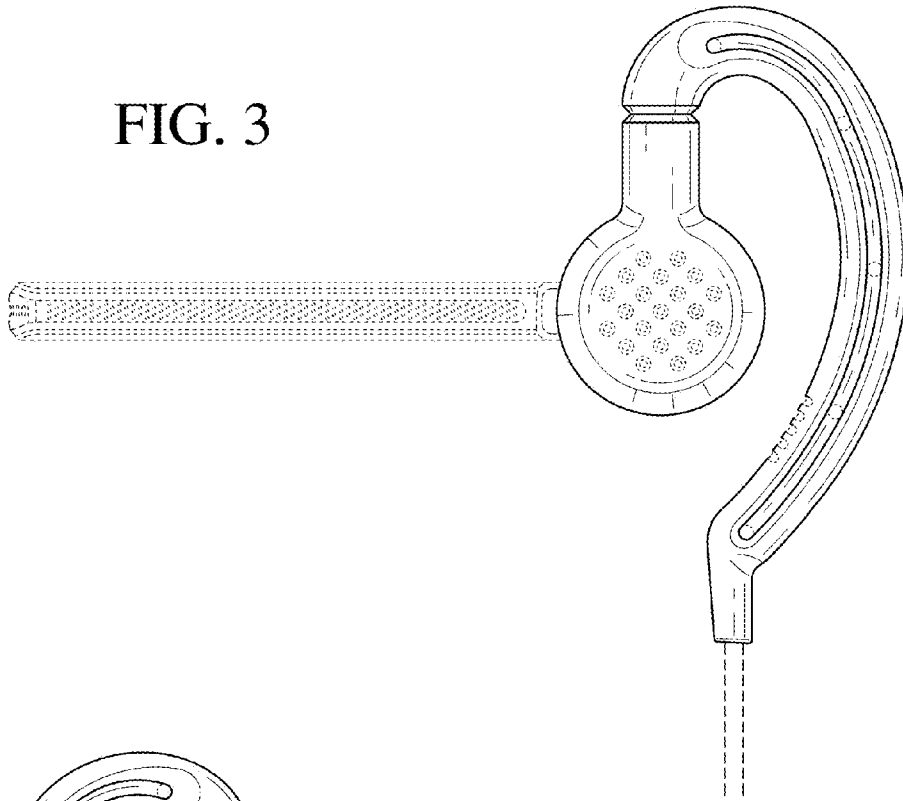

FIG. 4

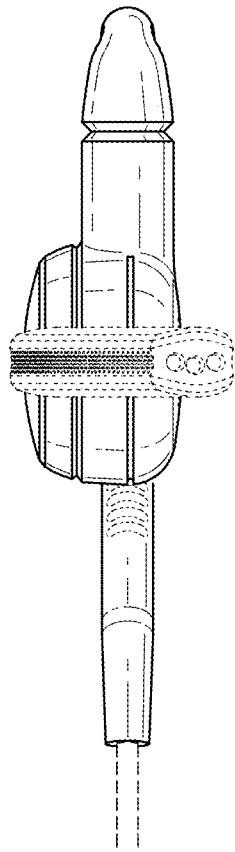

FIG. 5

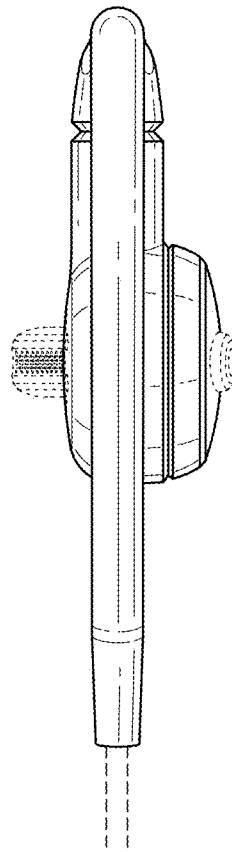

FIG. 6

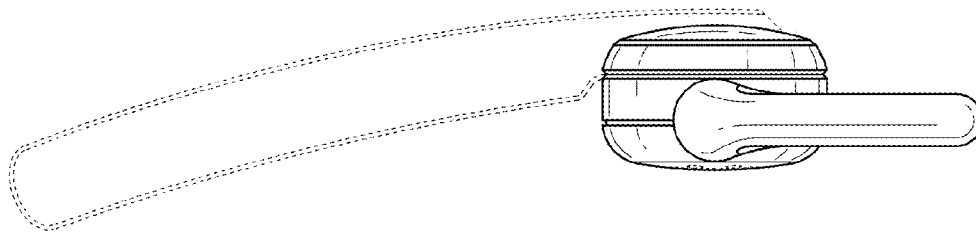

FIG. 7

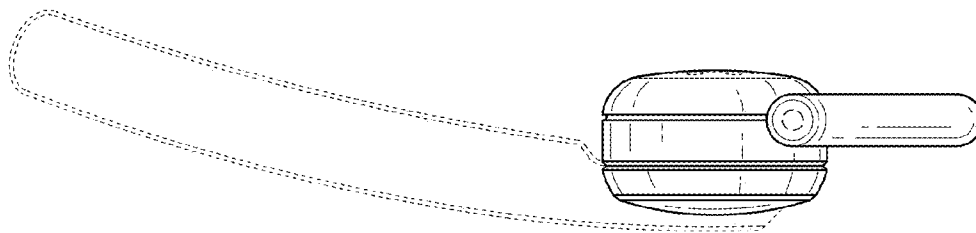

FIG. 8

FIG. 9

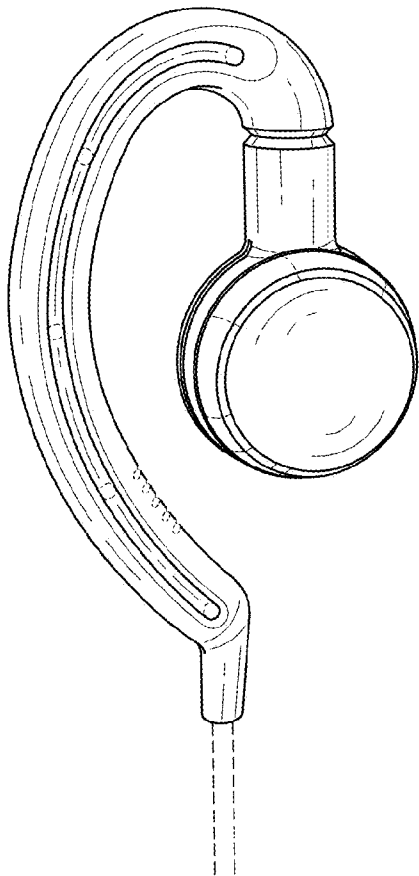
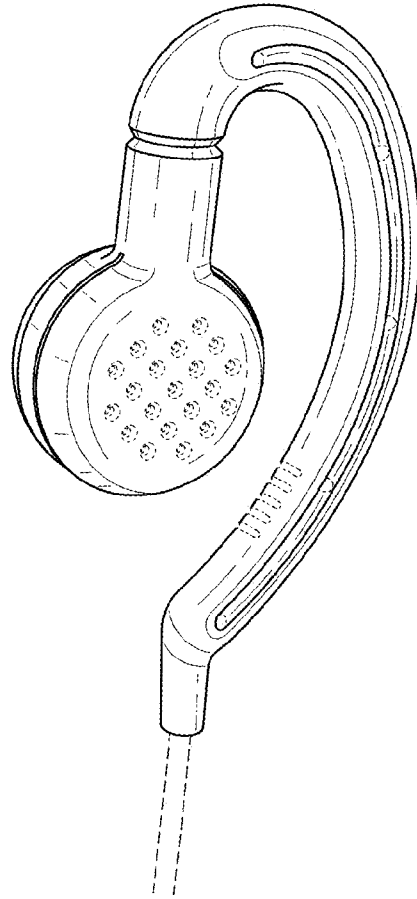

FIG. 10

FIG. 11

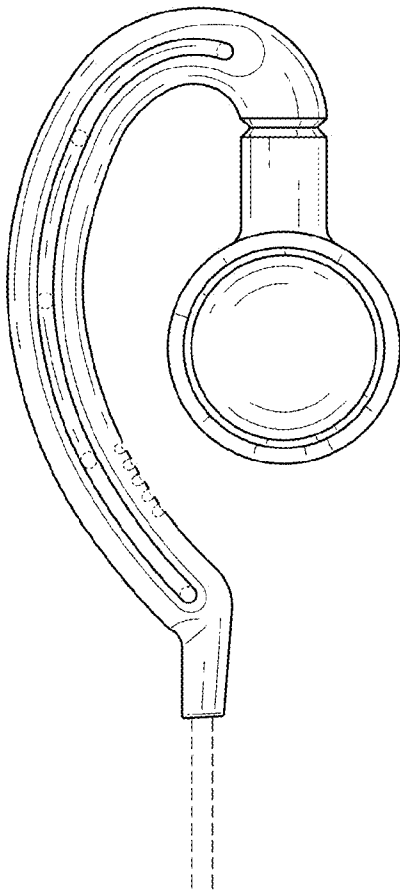
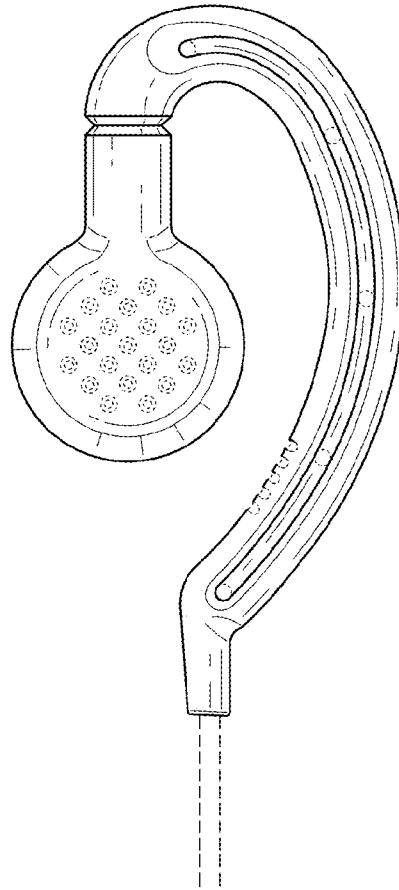

FIG. 12



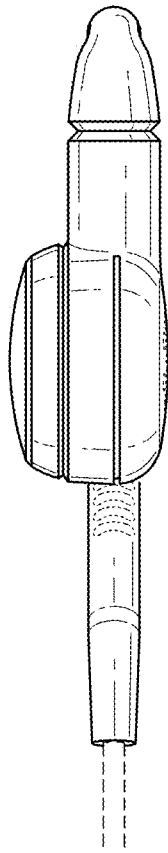

FIG. 13

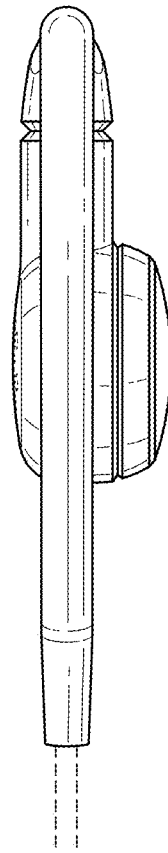

FIG. 14

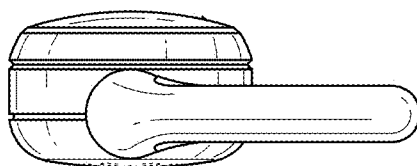

FIG. 15

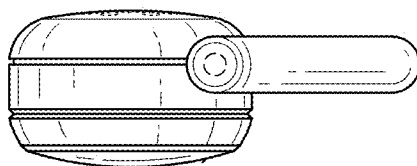

FIG. 16