



(86) Date de dépôt PCT/PCT Filing Date: 2004/03/26  
 (87) Date publication PCT/PCT Publication Date: 2004/10/14  
 (85) Entrée phase nationale/National Entry: 2005/09/19  
 (86) N° demande PCT/PCT Application No.: US 2004/009532  
 (87) N° publication PCT/PCT Publication No.: 2004/086950  
 (30) Priorités/Priorities: 2003/03/27 (60/458,854) US;  
 2003/06/11 (60/478,035) US; 2003/07/24 (60/490,082) US;  
 2003/10/02 (10/679,245) US

(51) Cl.Int.<sup>7</sup>/Int.Cl.<sup>7</sup> A61B 18/18  
 (71) Demandeur/Applicant:  
 CIERRA, INC., US  
 (72) Inventeurs/Inventors:  
 MALECKI, WILLIAM, US;  
 FRANCIS, DAN, US;  
 HORNE, KENNETH, US;  
 DEEM, MARK E., US;  
 GIFFORD, HANSON S., III, US;  
 ALEGANDRO, JOSE, US  
 (74) Agent: FETHERSTONHAUGH & CO.

(54) Titre : DISPOSITIFS A BASE D'ENERGIE ET METHODES POUR LE TRAITEMENT D'UN FORAMEN OVALE  
 PATENT

(54) Title: ENERGY BASED DEVICES AND METHODS FOR TREATMENT OF PATENT FORAMEN OVALE

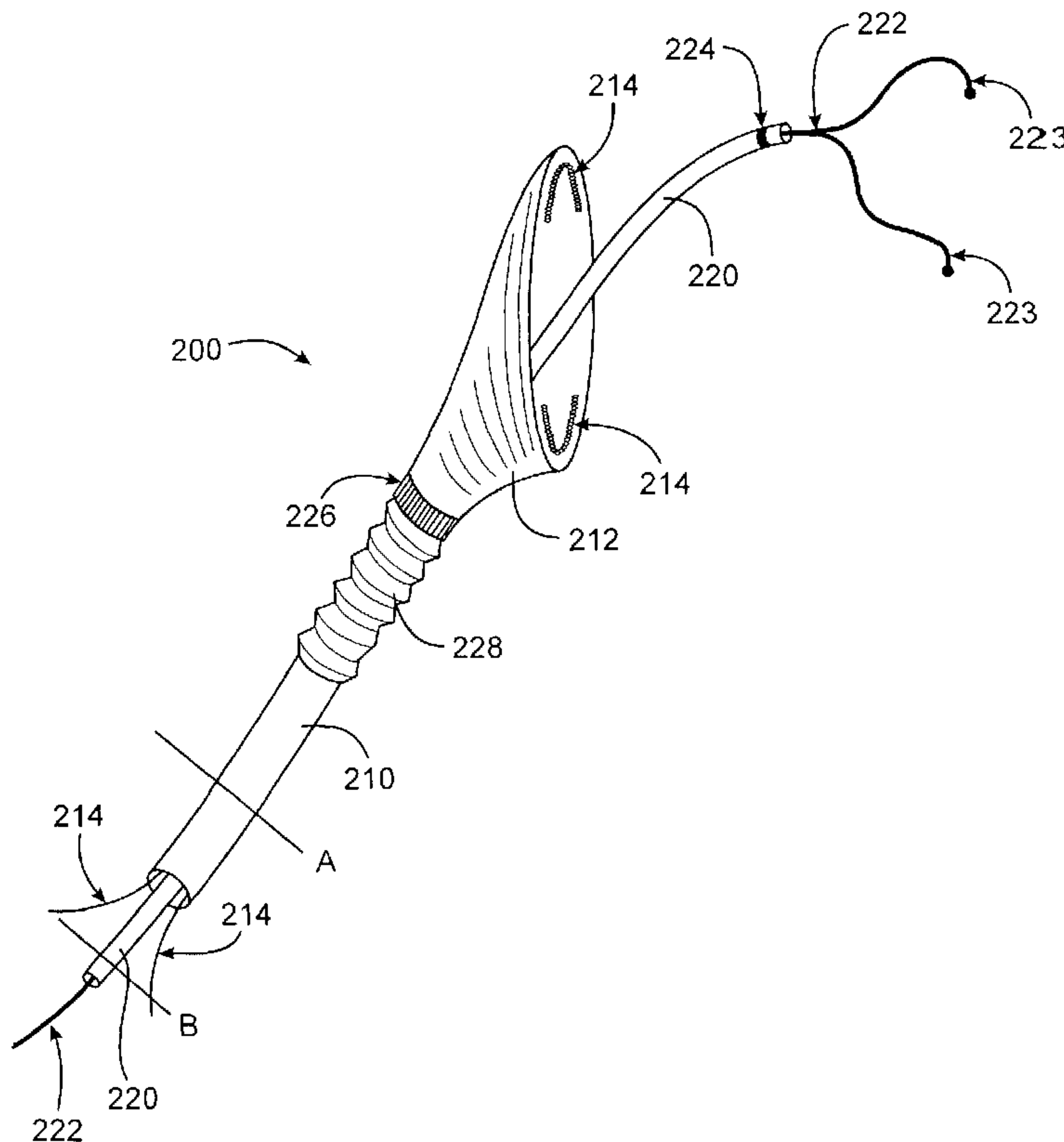

(57) **Abrégé/Abstract:**

Methods and apparatus for treatment of patent foramen ovale (PFO) provide for applying energy to tissues adjacent the PFO with a catheter device. The device includes a catheter device (200) having at least one energy transmission member (214) at or near the distal end. Some embodiments of the catheter device include one or more tissue apposition members (223) near the distal end for helping bring PFO tissues together, such as a PFO covering member, a vacuum applying member and/or the like.

(12) INTERNATIONAL APPLICATION PUBLISHED UNDER THE PATENT COOPERATION TREATY (PCT)

(19) World Intellectual Property  
Organization  
International Bureau



(43) International Publication Date  
14 October 2004 (14.10.2004)

PCT

(10) International Publication Number  
**WO 2004/086950 A3**

- (51) International Patent Classification<sup>7</sup>: **A61B 18/18**
- (21) International Application Number: PCT/US2004/009532
- (22) International Filing Date: 26 March 2004 (26.03.2004)
- (25) Filing Language: English
- (26) Publication Language: English
- (30) Priority Data:
- |            |                             |    |
|------------|-----------------------------|----|
| 60/458,854 | 27 March 2003 (27.03.2003)  | US |
| 60/478,035 | 11 June 2003 (11.06.2003)   | US |
| 60/490,082 | 24 July 2003 (24.07.2003)   | US |
| 10/679,245 | 2 October 2003 (02.10.2003) | US |
- (71) Applicant (for all designated States except US): **CIERRA, INC.** [US/US]; 199 Jefferson Drive, Menlo Park, CA 94025 (US).
- (72) Inventors; and  
(75) Inventors/Applicants (for US only): **MALECKI, William** [US/US]; 510 Clayton Street, San Francisco, CA 94117 (US). **FRANCIS, Dan** [US/US]; 1600 Villa Street, Apartment 392, Mountain View, CA 94941 (US). **HORNE, Kenneth** [US/US]; 926 Bautista Court, Palo Alto, CA 94303 (US). **DEEM, Mark, E.** [US/US]; 685 Sierra Avenue, Mountain View, CA 94041 (US). **GIFFORD, Hanson, S., III** [US/US]; 3180 Woodside Road, Woodside, CA 94062 (US). **ALEGANDRO, Jose** [US/US]; 617 Arcadia Terrace, Unit 101, Sunnyvale, CA 94087 (US).
- (74) Agents: **SMITH, Scott, M.** et al.; Townsend and Townsend and Crew LLP, Two Embarcadero Center, 8th Floor, San Francisco, CA 94111-3834 (US).
- (81) Designated States (unless otherwise indicated, for every kind of national protection available): AE, AG, AL, AM, AT, AU, AZ, BA, BB, BG, BR, BW, BY, BZ, CA, CH, CN, CO, CR, CU, CZ, DE, DK, DM, DZ, EC, EE, EG, ES, FI,

[Continued on next page]

(54) Title: ENERGY BASED DEVICES AND METHODS FOR TREATMENT OF PATENT FORAMEN OVALE

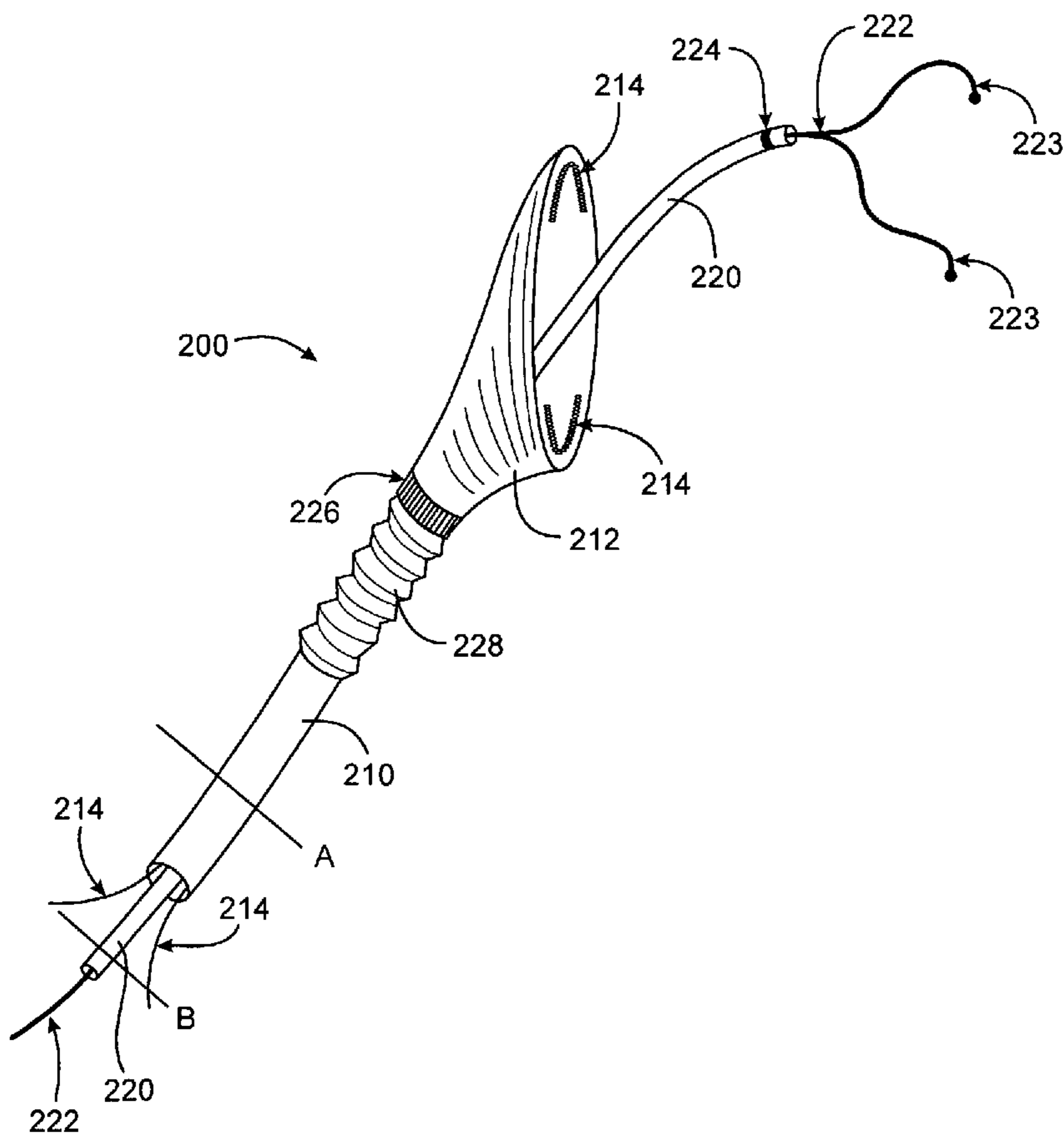

(57) Abstract: Methods and apparatus for treatment of patent foramen ovale (PFO) provide for applying energy to tissues adjacent the PFO with a catheter device. The device includes a catheter device (200) having at least one energy transmission member (214) at or near the distal end. Some embodiments of the catheter device include one or more tissue apposition members (223) near the distal end for helping bring PFO tissues together, such as a PFO covering member, a vacuum applying member and/or the like.

WO 2004/086950 A3

**WO 2004/086950 A3**

GB, GD, GE, GH, GM, HR, HU, ID, IL, IN, IS, JP, KE, KG, KP, KR, KZ, LC, LK, LR, LS, LT, LU, LV, MA, MD, MG, MK, MN, MW, MX, MZ, NA, NI, NO, NZ, OM, PG, PH, PL, PT, RO, RU, SC, SD, SE, SG, SK, SL, SY, TJ, TM, TN, TR, TT, TZ, UA, UG, US, UZ, VC, VN, YU, ZA, ZM, ZW.

TR), OAPI (BF, BJ, CF, CG, CI, CM, GA, GN, GQ, GW, ML, MR, NE, SN, TD, TG).

**Published:**

— *with international search report*

**(84) Designated States** (*unless otherwise indicated, for every kind of regional protection available*): ARIPO (BW, GH, GM, KE, LS, MW, MZ, SD, SL, SZ, TZ, UG, ZM, ZW), Eurasian (AM, AZ, BY, KG, KZ, MD, RU, TJ, TM), European (AT, BE, BG, CH, CY, CZ, DE, DK, EE, ES, FI, FR, GB, GR, HU, IE, IT, LU, MC, NL, PL, PT, RO, SE, SI, SK,

**(88) Date of publication of the international search report:**  
24 March 2005

*For two-letter codes and other abbreviations, refer to the "Guidance Notes on Codes and Abbreviations" appearing at the beginning of each regular issue of the PCT Gazette.*

## ENERGY BASED DEVICES AND METHODS FOR TREATMENT OF PATENT FORAMEN OVALE

### CROSS-REFERENCES TO RELATED APPLICATIONS

5 [0001] This application claims priority to U.S. Provisional Patent Application Nos.:  
60/458,854 (Attorney Docket No. 022128-000100US), filed on March 27, 2003; 60/478,035  
(Attorney Docket No. 022128-000110US), filed on June 11, 2003, and 60/490082 (Attorney  
Docket No. 022128-000120US), filed on July 24, 2003, the full disclosures of which are  
incorporated herein by reference. This application is related to U.S. Patent Application Nos.:  
10 10/665974 (Attorney Docket No. 022128-000300US), filed on September 16, 2003;  
10/679245 (Attorney Docket No. 022128-000200US), filed October 2, 2003; 10/787532  
(Attorney Docket No. 022128-000130US), filed February 25, 2004; and 10/\_\_\_\_\_  
(Attorney Docket No. 022128-000400US), filed concurrently with the present application,  
the full disclosures of which are incorporated herein by reference.

### 15 BACKGROUND OF THE INVENTION

[0002] The invention generally relates to medical devices and methods. More specifically,  
the invention relates to energy based devices and methods for treatment of patent foramen  
ovale.

[0003] Fetal blood circulation is much different than adult circulation. Because fetal blood  
20 is oxygenated by the placenta, rather than the fetal lungs, blood is generally shunted away  
from the lungs to the peripheral tissues through a number of vessels and foramens that remain  
patent (i.e., open) during fetal life and typically close shortly after birth. For example, fetal  
blood passes directly from the right atrium through the foramen ovale into the left atrium, and  
a portion of blood circulating through the pulmonary artery trunk passes through the ductus  
25 arteriosus to the aorta. This fetal circulation is shown in attached Figure 1.

[0004] At birth, as a newborn begins breathing, blood pressure in the left atrium rises above  
the pressure in the right atrium. In most newborns, a flap of tissue closes the foramen ovale  
and heals together. In approximately 20,000 babies born each year in the US, the flap of  
tissue is missing, and the hole remains open as an atrial septal defect (ASD). In a much more  
30 significant percentage of the population (estimates range from 5% to 20% of the entire  
population), the flap is present but does not heal together. This condition is known as a

patent foramen ovale (PFO). Whenever the pressure in the right atrium rises above that in the left atrium, blood pressure can push this patent channel open, allowing blood to flow from the right atrium to the left atrium.

5 [0005] Patent foramen ovale has long been considered a relatively benign condition, since it typically has little effect on the body's circulation. More recently, however, it has been found that a significant number of strokes may be caused at least in part by PFO. In some cases, stroke may occur because a PFO allows blood containing small thrombi to flow directly from the venous circulation to the arterial circulation and into the brain, rather than flowing to the lungs where the thrombi can become trapped and gradually dissolved. In other cases, thrombi might form in the patent channel of the PFO itself and become dislodged when the pressures cause blood to flow from the right atrium to the left atrium. It has been estimated that patients with PFOs who have already had cryptogenic strokes have a 4% risk per year of having another stroke.

15 [0006] Further research is currently being conducted into the link between PFO and stroke. At the present time, if someone with a PFO has two or more strokes, the healthcare system in the U.S. may reimburse a surgical or other interventional procedure to definitively close the PFO. It is likely, however, that a more prophylactic approach would be warranted to close PFOs to prevent the prospective occurrence of a stroke. The cost and potential side-effects and complications of such a procedure must be low, however, since the event rate due to PFOs is relatively low. In younger patients, for example, PFOs sometimes close by themselves over time without any adverse health effects.

25 [0007] Another highly prevalent and debilitating condition--chronic migraine headache--has also been linked with PFO. Although the exact link has not yet been explained, PFO closure has been shown to eliminate or significantly reduce migraine headaches in many patients. Again, prophylactic PFO closure to treat chronic migraine headaches might be warranted if a relatively non-invasive procedure were available.

30 [0008] Currently available interventional therapies for PFO are generally fairly invasive and/or have potential drawbacks. One strategy is simply to close a PFO during open heart surgery for another purpose, such as heart valve surgery. This can typically be achieved via a simple procedure such as placing a stitch or two across the PFO with vascular suture. Performing open heart surgery purely to close an asymptomatic PFO or even a very small ASD, however, would be very hard to justify.

[0009] A number of interventional devices for closing PFOs percutaneously have also been proposed and developed. Most of these devices are the same as or similar to ASD closure devices. They are typically "clamshell" or "double umbrella" shaped devices which deploy an area of biocompatible metal mesh or fabric (ePTFE or Dacron, for example) on each side of the atrial septum, held together with a central axial element, to cover the PFO. This umbrella then heals into the atrial septum, with the healing response forming a uniform layer of tissue or "pannus" over the device. Such devices have been developed, for example, by companies such as Nitinol Medical Technologies, Inc. (Boston, MA) and AGA Medical, Inc. (White Bear Lake, MN). U.S. Patent No. 6,401,720 describes a method and apparatus for thoracoscopic intracardiac procedures which may be used for treatment of PFO.

[0010] Although available devices may work well in some cases, they also face a number of challenges. Relatively frequent causes of complications include, for example, improper deployment, device embolization into the circulation and device breakage. In some instances, a deployed device does not heal into the septal wall completely, leaving an exposed tissue which may itself be a nidus for thrombus formation. Furthermore, currently available devices are generally complex and expensive to manufacture, making their use for prophylactic treatment of PFO impractical. Additionally, currently available devices typically close a PFO by placing material on either side of the tunnel of the PFO, compressing and opening the tunnel acutely, until blood clots on the devices and causes flow to stop.

[0011] Research into methods and compositions for tissue welding has been underway for many years. Of particular interest are technologies developed by McNally et.al., (as shown in U.S. Patent No. 6,391,049) and Fusion Medical (as shown in U.S. Patents Nos. 5,156,613, 5,669,934, 5,824,015 and 5,931,165). These technologies all disclose energy delivery to tissue solders and patches to join tissue and form anastomoses between arteries, bowel, nerves, etc. Also of interest are a number of patents by inventor Sinofsky, relating to laser suturing of biological materials (e.g., U.S. Patent Nos. 5,725, 522, 5,569,239, 5,540,677 and 5,071,417). None of these disclosures, however, show methods or apparatus suitable for positioning the tissues of the PFO for welding or for delivering the energy to a PFO to be welded.

[0012] Causing thermal trauma to a patent ovale has been described in two patent applications by Stambaugh et al. (PCT Publication Nos. WO 99/18870 and WO 99/18871).

The devices and methods described, however, cause trauma to PFO tissues to hopefully eventually cause scar tissue formation which will close the PFO. Using such devices and methods, the PFO actually remains patent immediately after the procedure and only closes sometime later. Therefore, a physician may not know whether the treatment has worked until  
5 long after the treatment procedure has been performed. Frequently, scar tissue may fail to form or may form incompletely, resulting in a still patent PFO.

[0013] Therefore, it would be advantageous to have improved methods and apparatus for treating a PFO. Ideally, such methods and apparatus would help seal the PFO during, immediately after or soon after performing a treatment procedure. Also ideally, such devices  
10 and methods would leave no foreign material (or very little material) in a patient's heart. Furthermore, such methods and apparatus would preferably be relatively simple to manufacture and use, thus rendering prophylactic treatment of PFO, such as for stroke prevention, a viable option. At least some of these objectives will be met by the present invention.

15

#### BRIEF SUMMARY OF THE INVENTION

[0014] The present invention generally provides devices and methods for treating patent foramen ovale (PFO). More specifically, the devices and methods involve advancing a catheter device to a position in the heart for treating the patent foramen ovale and applying  
20 energy to (or removing energy from) tissues adjacent a PFO to substantially close the PFO acutely. By "substantially," it is meant that a stable tissue bridge will be formed across the PFO, which will withstand physiologic pressures. A substantially closed PFO, however, may still have one or more small gaps or openings, which will in at least some cases close over time via the healing process. By "acutely," it is meant that the PFO is substantially closed  
25 when the closure procedure is completed. Thus, acute closure distinguishes devices and methods of the present invention from prior protocols, which rely on delayed PFO closure via tissue healing and scarring. "Acutely," for purposes of this application, does not mean temporarily, since devices and methods of the present invention will typically provide for permanent (or at least long-term) PFO closure.

30 [0015] The phrase "tissues adjacent a PFO," or simply "PFO tissues," for the purposes of this application, means any tissues in, around or in the vicinity of a PFO which may be used or manipulated to help close the PFO. For example, tissues adjacent a PFO include septum

The devices and methods described, however, cause trauma to PFO tissues to hopefully eventually cause scar tissue formation which will close the PFO. Using such devices and methods, the PFO actually remains patent immediately after the procedure and only closes sometime later. Therefore, a physician may not know whether the treatment has worked until  
5 long after the treatment procedure has been performed. Frequently, scar tissue may fail to form or may form incompletely, resulting in a still patent PFO.

[0013] Therefore, it would be advantageous to have improved methods and apparatus for treating a PFO. Ideally, such methods and apparatus would help seal the PFO during, immediately after or soon after performing a treatment procedure. Also ideally, such devices  
10 and methods would leave no foreign material (or very little material) in a patient's heart. Furthermore, such methods and apparatus would preferably be relatively simple to manufacture and use, thus rendering prophylactic treatment of PFO, such as for stroke prevention, a viable option. At least some of these objectives will be met by the present invention.

15

#### BRIEF SUMMARY OF THE INVENTION

[0014] The present invention generally provides devices and methods for treating patent foramen ovale (PFO). More specifically, the devices and methods involve advancing a catheter device to a position in the heart for treating the patent foramen ovale and applying  
20 energy to (or removing energy from) tissues adjacent a PFO to substantially close the PFO acutely. By "substantially," it is meant that a stable tissue bridge will be formed across the PFO, which will withstand physiologic pressures. A substantially closed PFO, however, may still have one or more small gaps or openings, which will in at least some cases close over time via the healing process. By "acutely," it is meant that the PFO is substantially closed  
25 when the closure procedure is completed. Thus, acute closure distinguishes devices and methods of the present invention from prior protocols, which rely on delayed PFO closure via tissue healing and scarring. "Acutely," for purposes of this application, does not mean temporarily, since devices and methods of the present invention will typically provide for permanent (or at least long-term) PFO closure.

30 [0015] The phrase "tissues adjacent a PFO," or simply "PFO tissues," for the purposes of this application, means any tissues in, around or in the vicinity of a PFO which may be used or manipulated to help close the PFO. For example, tissues adjacent a PFO include septum



primum tissue, septum secundum tissue, atrial septal tissue lateral to the septum primum or septum secundum, tissue within the tunnel of the PFO, tissue on the right atrial surface or the left atrial surface of the atrial septum and the like. By "application or removal" of energy, it is meant that energy may be transferred either to or from PFO tissues. In various  
5 embodiments, any of a number of energy transfer devices and forms of energy may be used to provide such energy transfer. Types of energy used may include, for example, radiofrequency energy, cryogenic energy, laser energy, ultrasound energy, resistive heat energy, microwave energy and the like.

[0016] Application of energy to (or removal of energy from) tissues to substantially close  
10 the PFO acutely may sometimes be referred to as "tissue welding." Preferably, tissue welding methods of the present invention will be performed without using tissue soldering material or other foreign material. In some embodiments, however, it may be advantageous to use one or more solder materials. Various solders and other tissue soldering matrices are described more fully in U.S. Patent Application No. 10/\_\_\_\_\_, which was previously  
15 incorporated by reference. Examples of tissue solders or adhesives which may be used include, but are not limited to, autologous blood, albumin, collagen, fibrin, cyanoacrylates, mussel byssus adhesives, polymer hot melt adhesives and the like.

[0017] In some embodiments of the present invention, devices and methods further provide for bringing tissues adjacent a PFO together (or "apposing" tissues). In various embodiments,  
20 tissues may be apposed before, during and/or after application or removal of energy to the tissues. Generally, energy application or removal will act to denature collagen in the PFO tissues. If the tissues are apposed before and/or during denaturation and/or while the collagen in the tissues is allowed to renature, the collagen in once-separated tissues binds together to bring the tissues together. Therefore, although not required, some embodiments of the  
25 invention include one or more devices for bringing (and possibly holding) tissues together before, during and/or after energy application or removal. Such devices include, for example, PFO tissue covering members, which may also be suction or vacuum application members, expandable members within the PFO tunnel, distal tip members for contacting a left atrial surface of PFO tissue and the like. By providing for substantial, acute closure of a PFO,  
30 devices and methods of the invention may be advantageous for preventing stroke, treating migraine headaches and/or preventing or treating other medical conditions caused or exacerbated by PFO.

[0018] In one aspect of the present invention, a method of treating a PFO in a heart involves advancing a catheter device to a position in the heart for treating the PFO and applying energy to the tissues with the catheter device to substantially close the PFO acutely. In some embodiments, as just mentioned, the method further includes bringing the tissues at least partially together, preferably using the catheter device but in some embodiments using a separate device. For example, in some embodiments the tissues are brought together before applying the energy. Optionally, the tissues may then be held together while applying the energy. In some embodiments, the tissues are held together after the energy has been applied as well. The method may also involve cooling the tissues after the energy has been applied.

10 [0019] Bringing the tissues at least partially together may be accomplished by any of a number of suitable devices and methods. In one embodiment, for example, the tissues are contacted with a tissue covering member adjacent a distal end of the catheter device. The tissue covering member may cause blood pressure in a left atrium of the heart to bring the tissues at least partially together. In some embodiments, the tissue covering member may be further used to apply vacuum force to the tissues.

[0020] Although the catheter device may be positioned in a number of different locations for treating a PFO, in some embodiments advancing the catheter involves positioning a distal end of the catheter in a right atrium of the heart. Advancing the catheter may also include advancement over a guide catheter or guidewire extending into the PFO. Optionally, the guide catheter or guidewire may extend through the PFO into a left atrium of the heart.

[0021] In some embodiments, the method further includes retracting a sheath portion of the guide catheter to expose an expanding member within the PFO, the exposed expanding member bringing the tissues adjacent the PFO at least partially together. Such an expanding member may provide lateral force to the tissues adjacent the PFO, for example, and in some embodiments will do so without extending into the left atrium. As is explained further below, such expanding members may comprise "fishmouth," two-pronged members in one embodiment, and may be constructed of shape memory materials, spring-loaded materials or the like. By spreading PFO tissues laterally between two prongs (for example), the tissues come together in the area between the prongs. Optionally, the method may also include contacting a left atrial surface of at least one of a septum primum and a septum secundum with a distal portion of the expanding member and retracting the expanding member to bring the tissues adjacent the PFO together. For example, the distal portion may contact the septum

primum and pull it toward the right side of the heart, into contact with the septum secundum. At some point after the expanding member has been used to appose the tissues adjacent the PFO, it may be advantageous to retract the expanding member to a position within the guide catheter. For example, the expanding member may be retracted in some embodiments before removing the guide catheter through the main catheter device.

[0022] As mentioned, in some embodiments the catheter device may be advanced over a guidewire rather than a guide catheter. The guidewire typically extends through the PFO and may include an expanding portion along its length for expanding within the PFO. Optionally, the guidewire may extend into the left atrium, and the method may optionally include contacting a left atrial surface of at least one of a septum primum and a septum secundum with a distal portion of the guidewire and retracting the guidewire to bring the tissues adjacent the PFO together.

[0023] Any suitable type of energy may be applied to the PFO tissues to provide acute PFO closure. In some embodiments, for example, monopolar or bipolar radiofrequency energy is applied, while in alternative embodiments cryogenic, resistive heat, ultrasound, microwave, or laser energy, heat energy in the form of heated fluid such as saline, or the like may be applied. Energy may be applied by energizing a single conductive member of the catheter device or multiple conductive members, in various embodiments. Generally, any suitable devices for energy delivery are contemplated.

[0024] Some embodiments of the method may further involve monitoring an amount of energy applied to the tissues. For example, monitoring the energy may involve monitoring a temperature of the tissues, an impedance of the tissues and/or the like. Such a method may further involve determining when a sufficient amount of energy has been applied to the tissues to acutely close the PFO. Optionally, the method may also include discontinuing the application of energy when the sufficient amount of energy has been applied.

[0025] Any of the above methods may also involve directly visualizing the PFO and the adjacent tissues using at least one visualization device coupled with the catheter device. Such a visualization device may include a fiber optic device, an ultrasound device or any other suitable visualization device.

[0026] In another aspect of the invention, a method of treating a PFO in a heart involves advancing a catheter device to a position in the heart for treating the patent foramen ovale and removing energy from tissues adjacent the patent foramen ovale with the catheter device to

substantially close the patent foramen ovale acutely. Removing energy from the tissues may be achieved using any suitable device(s), such as by contacting the tissues with one or more cryogenic energy members. Any of the additional or alternative method steps described above may be applied to this aspect of the invention.

5 [0027] In another aspect of the invention, apparatus for treating a PFO in a heart includes a catheter device having a proximal end and a distal end and at least one energy transmission member adjacent the distal end for applying energy to, or removing energy from, tissues adjacent a PFO to acutely close the PFO. Some embodiments further include at least one tissue apposition member adjacent the distal end for at least partially bringing the tissues  
10 together. In some embodiments, the tissue apposition member comprises a tissue covering member. The tissue covering member may have any suitable configuration and be constructed from any suitable material(s). In some embodiments, for example, the tissue covering member has a suction cup or cone shape.

[0028] In some embodiments, the tissue covering member fully covers the opening of the  
15 PFO to allow blood pressure in a left atrium of the heart to bring the tissues together. Additionally, the tissue covering member may comprise a suction member for applying vacuum force to the tissues to bring the tissues together. Optionally, the tissue covering member may be expandable from a first delivery dimension to a second treatment dimension. In some embodiments, the catheter further comprises a flexible isolation portion disposed  
20 between the tissue covering member and the catheter device to prevent unwanted movement of the tissue covering member during use. In some embodiments, the at least one energy transmission member is coupled with the tissue covering member.

[0029] Some embodiments of the apparatus further include a guide member for advancing through the PFO, with the catheter device being slidably disposed over the guide member.  
25 The guide member may include, for example a guide catheter and at least one expandable member disposed within the guide catheter, wherein the guide catheter is retractable to expose the expandable member to allow it to expand within the PFO. The expandable member, in turn, may have any suitable configuration, but in some embodiments it includes at least two members that expand apart to provide lateral force to the tissues adjacent the  
30 PFO, such as a "fishmouth" or two-prong expandable member. When exposed, the expanding member may also provide dilatory force to the tissues adjacent the PFO. To

provide expandability, the expandable member may be made of shape memory material, may be spring loaded, and/or the like.

[0030] In alternative embodiments, the guide member may comprise a guidewire having an expandable portion along its length. For example, the expandable portion may be a divided  
5 portion, the divided portion comprising expandable shape memory material. Optionally, the guide member may include at least one tip for contacting a left atrial surface of the tissues adjacent the PFO. Such a tip may be conformable to the left atrial surface. The guide member may be retractable to engage the at least one tip with the left atrial surface.

[0031] In any of the above embodiments, one or more guide members, or component parts  
10 of a guide member, may act as one or more energy transmission members. In some embodiments, for example, an expanding member may act as a monopolar or bipolar radiofrequency electrode.

[0032] The at least one energy transmission member of the catheter device may comprise any suitable energy transmission device or combination of devices. For example, the  
15 transmission member may transmit radiofrequency energy, cryogenic energy, resistive heat energy, ultrasound energy, microwave energy, laser energy or any other form of energy for treating PFO tissues. In preferred embodiments, the energy transmission member comprises a monopolar or two bipolar radiofrequency transmission members. Such a transmission member, for example, may be curved to approximate the curvature of the PFO. In other  
20 embodiments, straight transmission members, mesh or braided transmission members, multiple pin-point transmission members or the like may be used.

[0033] In some embodiments, the energy transmission member(s) are coupled with the tissue apposition member. Thus, tissues may be brought into apposition and energy may be applied using the tissue apposition member. In some embodiments, energy transmission  
25 member is movable along at least part of a circumference of the at least one tissue apposition member. In alternative embodiments, the energy transmission member comprises a guide member for advancing through the PFO, with the catheter device being slidably disposed over the guide member. Again, the guide member typically includes at least one expandable portion for expanding within the PFO to at least partially bring together the tissues adjacent  
30 the PFO, and in some embodiments the expandable member acts as the energy transmission member(s). In still other embodiments, energy transmission members may be coupled with both the tissue apposition member and the guide member/expandable member.

[0034] Apparatus of the invention may further include at least one sensor coupled with the catheter device for sensing an amount of energy delivered to the tissues by the at least one energy transmission member. Sensors, for example, may be infrared sensors, thermistors, thermocouples or the like, though any sensors may be used. Optionally, a microprocessor  
5 may be coupled with the at least one sensor for processing sensed data to determine when the amount of delivered energy has reached a desired amount of energy.

[0035] These and other embodiments are described in further detail in the following description related to the appended drawing figures.

10 BRIEF DESCRIPTION OF THE DRAWING FIGURES

[0036] FIG. 1 is a diagram of the fetal circulation;

[0037] FIG. 2 is a diagram of a catheter apparatus according to an embodiment of the present invention, having a conductive element and closure device, the catheter passing through the inferior vena cava and right atrium and through the PFO;

15 [0038] FIG. 3 is a perspective view of a catheter apparatus according to an embodiment of the present invention;

[0039] FIG. 3A and 3B are cross-sectional views of the catheter apparatus in FIG. 3;

[0040] FIG. 4 is a perspective view of a catheter apparatus according to another embodiment of the present invention;

20 [0041] FIGS. 5A and 5B are perspective views of a catheter apparatus according to another embodiment of the present invention;

[0042] FIG. 6 is a perspective view of a catheter apparatus according to another embodiment of the present invention;

25 [0043] FIG. 7 is a perspective view of a catheter apparatus according to another embodiment of the present invention; and

[0044] FIGS. 8A-8E demonstrate a method for treating a PFO using a catheter apparatus according to an embodiment of the present invention.

## DETAILED DESCRIPTION OF THE INVENTION

[0045] Devices and methods of the present invention generally provide for patent foramen ovale (PFO) treatment through application or removal of energy. Methods involve advancing a catheter device to a position in the heart for treating the PFO and applying energy to (or  
5 removing energy from) tissues adjacent a PFO to substantially close the PFO acutely. Terms such as "substantially," "acutely," and "tissues adjacent the PFO" are defined above in the Brief Summary of the Invention. Devices of the invention generally include a catheter device having a proximal end and a distal end and at least one energy transmission member adjacent the distal end for applying energy to or removing energy from tissues adjacent the PFO.

10 [0046] As mentioned above in the background section, Figure 1 is a diagram of the fetal circulation. The foramen ovale is shown, with an arrow demonstrating that blood passes from the right atrium to the left atrium in the fetus. After birth, if the foramen ovale fails to close (thus becoming a PFO), blood may travel from the right atrium to the left atrium or vice versa, causing increased risk of stroke, migraine and possibly other adverse health conditions,  
15 as discussed above.

[0047] With reference to Figure 2, one embodiment of a PFO-treatment apparatus 100 may be advanced through the vasculature of a patient to a position in the heart for treating a PFO. In this embodiment, apparatus 100 includes an elongate catheter device 110 having one or more tissue apposition members 112 and one or more energy transmission members 114 at or  
20 near its distal end. Optionally, catheter device 110 may be slidably disposed over a guide member 120, such as a guide catheter (as in Figure 1), a guidewire, or the like. Guide member 120 may include, for example, one or more expanding members 122 or other similar devices for deploying within the PFO to help appose the adjacent tissues. In some embodiments, as described further below, expanding members 122 may comprise (or be  
25 coupled with) one or more energy transmission members 114. Generally, apparatus 100 may be used to bring together tissues surrounding and/or adjacent the PFO and to transmit energy to the tissues to close the PFO.

[0048] Although the embodiment in Figure 2 and many of the embodiments described below include one or more tissue apposition members, devices of the present invention do not  
30 require such members. In some embodiments, as mentioned above and as set forth in the claims, devices may include a catheter device having one or more energy transmission members for applying or removing energy, without any components designed for bringing

the tissues together. Therefore, although much of the following discussion focuses on embodiments including tissue apposition members and the like, such members are not required.

[0049] Referring now to Figure 3, one embodiment of a PFO-treatment apparatus 200  
5 suitably includes a catheter device 210 coupled with a tissue apposition member 212 at its distal end. One or more energy transmission members 214 may be disposed through or within catheter device 210 and/or coupled with tissue apposition member 212. In some  
10 embodiments, catheter device 210 is slidably disposed over a guide catheter 220. Guide catheter 220 may contain one or more expandable elements 222, such as a guide wire or the like. One or more radiopaque markers 224, 226 may be included on catheter device 210,  
guide catheter 220 or both. Catheter device 210 may also include an isolation portion 228 for helping to stabilize tissue apposition member 212 during use, so that it is not caused to move due to the flexibility of catheter device 210.

[0050] Figures 3A and 3B show cross-sectional views of apparatus 200 from the  
15 perspective of lines A and B in Figure 3, respectively. In Figure 3A, catheter device 210 is shown, having a guide catheter lumen 232, two energy transmission member lumens 234 and a vacuum lumen 236. As shown in Figure 3B, guide catheter 220 includes an expandable  
20 element lumen 238. Guide catheter lumen 232 may sometimes be configured with an inner diameter (or "profile") that is shaped (or "keyed") to allow guide catheter 220 to pass easily through lumen 232. This feature is demonstrated in Figures 3A and 3B, where guide catheter 220 and guide catheter lumen 232 each have an ovoid shape.

[0051] In general, catheter device 210 comprises an elongate, flexible catheter which may  
25 be advanced through the vasculature of a patient to a position in the heart for treating a PFO. Thus, catheter device 210 may have any suitable length, diameter, cross-sectional profile and the like, and may be constructed of any suitable material. Tissue apposition member 212 (or  
multiple tissue apposition members in some embodiments) is disposed at or near the distal end of catheter device 210. Although many different types of devices may be used to bring  
30 tissues of the PFO together, in one embodiment (shown in Figure 2) tissue apposition member 212 comprises a PFO-covering member. PFO-covering tissue apposition member 212 may be positioned to contact adjacent PFO tissues to fully cover, or block, the opening of the PFO. This blocking of the PFO may prevent right-to-left shunting of blood and may allow blood pressure in the left atrium to bring the septum primum and septum secundum at



least partially together to close the PFO. Therefore, simply by forming a seal or blockage over the PFO, tissue apposition member 212 may help bring the PFO tissues together to assist in PFO closure.

5 [0052] In this and other embodiments, tissue apposition member 212 may also include one or more vacuum members for applying vacuum to the PFO tissues. In one embodiment, for example, suction lumen 236 (Figure 3A) may extend from the proximal end to the distal end of catheter device 210, opening into one or more vacuum-application apertures at the distal end of tissue apposition member 212. The vacuum-application aperture(s) may have any suitable configuration, such as a continuous aperture encircling tissue apposition member 10 212, multiple apertures encircling tissue apposition member 212 or in any other suitable configuration at or near its distal end, or the like. In still another embodiment, vacuum may be applied via a large, central lumen in tissue apposition member 212. In any case, vacuum force may be used to bring PFO tissues together and/or to secure tissue apposition member 212 and thus catheter device 210 to the PFO tissues.

15 [0053] Tissue apposition member 212, especially when configured as a PFO-covering member, may be collapsible/expandable to facilitate advancement and delivery of catheter device 210. For example, tissue apposition member 212 may comprise a collapsible polymeric cover disposed over an expandable/collapsible frame. In other embodiments, tissue apposition member 212 may be constructed of a shape memory material, such as 20 nitinol or another shape memory metal, spring stainless steel or the like, to allow catheter device 210 to be delivered through vasculature and then allow tissue apposition member 212 to expand to contact and appose the PFO tissues. In some embodiments, catheter device 210 and tissue apposition member 212 may be delivered to a location for PFO treatment through an introducer sheath. To further enhance the use of apparatus 200, an angle between catheter 25 device 210 and tissue apposition member 212 may be selected to approximate a convenient angle for delivery and/or deployment. In one embodiment, for example, the angle between catheter device 210 and tissue apposition member 212 may approximate the angle between the inferior vena cava and the interatrial septum. Any other configuration, combination of angles and the like is contemplated, however. In some embodiments, for example, direct 30 steering of the angle of tissue apposition member 212 relative to catheter device 210 may be employed to enhance delivery of catheter device 210 to a treatment site.

[0054] To further facilitate use of apparatus 200, catheter device 210 may include one or more radiopaque markers 226 for facilitating visualization of the device 210. Catheter device 210 may also include a "flexible isolation portion" 228, which in some embodiments comprises a rigid but shapeable portion disposed toward the distal end of catheter device 210, between tissue apposition member 212 and the generally flexible proximal portion of catheter device 210. Flexible isolation portion 228 may help to isolate tissue apposition member 212 from some or all movement experienced by the more flexible, proximal portion of catheter device 210, thus allowing a PFO treatment procedure to be performed without significant movement of tissue apposition member 212. In other embodiments, flexible isolation portion 228 may be more flexible than the more proximal portion of catheter device 210, thus enhancing maneuverability, shapability or the like of the position of tissue apposition member 212 relative to the more proximal portion.

[0055] Energy transmission members 214 may comprise any of a number of devices and may transmit any suitable type of energy for closing a PFO. Some types of energy which may be used, for example, include radiofrequency, cryogenic, resistive heat, ultrasound, microwave and laser energy. Radiofrequency energy transmission members 214 may be either monopolar or bipolar, with monopolar catheter devices also including a grounding member. Energy transmission members 214 may have any suitable configuration. For example, they may have a curved shape to approximate a radius of curvature of the PFO, as shown in Figure 3, or they may be configured as points for spot-welding the PFO tissues, as a circular member for welding around the circumference of PFO tissues, as one or more mesh or braided members disposed within the orifice of tissue apposition member 212 or the like. In some embodiments, energy transmission members 214 are fixedly coupled with tissue apposition member 212, while in other embodiments energy transmission members 214 are movable within tissue apposition member, for example to move about the circumference of the PFO to weld PFO tissues at multiple locations.

[0056] As mentioned earlier, the phrase "tissue welding" herein is used to mean application of energy to (or removal of energy from) PFO tissues to substantially and acutely close the PFO. Energy transmission members 214 generally provide for transfer of energy to or from PFO tissues to denature collagen in the tissues, and when the collagen is allowed to renature, with the tissues apposed, the once separated tissues bind together to form a stable tissue bridge. This stable tissue bridge substantially and acutely closes the PFO, preferably permanently. PFO tissues may, in some embodiments, be brought and held together by one

or more tissue apposition members 212. Energy transmission members 214 provide sufficient energy transfer, for a sufficient time, to weld the tissues. The time span of energy transmission may be, for example, from about 0.5 seconds to about 15 minutes, and more preferably from about 30 seconds to about 5 minutes. Energy transmission, in some  
5 embodiments, may be from about 0.5 Watts to about 100 Watts, and more preferably from about 2 Watts to about 20 Watts. Any other suitable energy and timing combination may also be used. In one experimental example, a PFO in a section of pig heart tissue used ex-  
vivo in a flowing saline test fixture was closed by applying suction to appose the PFO tissues and applying RF energy at approximately 25 watts for 7 minutes. RF energy application was  
10 then discontinued, but suction was continued for an additional 1 minute to keep tissues in apposition while the tissue cooled, to allow collagen in the tissues to reorganize and bind together to form a stable tissue bridge. Many other energy amounts, energy application times, tissue apposition times and the like are contemplated, however.

[0057] Although any type of energy may be transmitted by energy transmission members  
15 214, some embodiments will make use of monopolar or bipolar radiofrequency (RF) energy. Devices may use monopolar radiofrequency energy, for example, wherein energy is applied simultaneously to all conductive elements, completing the circuit through an external ground pad affixed to the skin of the patient. Alternatively, bipolar energy may be applied to all  
20 conductive elements simultaneously, and the circuit completed through a ground element incorporated elsewhere on apparatus 200. Further embodiments may include applying bipolar energy between two or more energy transmission members 214, which are electrically isolated from one another within catheter device 210.

[0058] Control systems coupled with energy transmission members 214 or tissue  
apposition member 212, or otherwise disposed within apparatus 200, may sense an amount of  
25 energy delivered to PFO tissues and, optionally, may automatically stop energy delivery upon detecting a change in condition of energy delivery, for instance an increase in electrical resistance or impedance in PFO tissues or in apparatus 200, an increased energy draw from the treatment apparatus, and/or the like. In some embodiments, energy delivery may be  
30 automatically stopped when an amount of delivered energy reaches a desired level, such as an amount of energy sufficient to substantially close the PFO. The amount of delivered energy may be monitored by any suitable method, such as monitoring temperature or impedance in PFO tissues or the like. In some embodiments, one or more sensors coupled with tissue apposition member 212, energy transmission members 214, or any other part of apparatus

200 may be used for monitoring such indicia. Examples of sensor devices include but are not limited to infrared sensing devices, thermistors and thermocouples. A control system may also include a microprocessor coupled with the sensors to determine when a desired amount of energy has been delivered and/or to automatically stop energy transmission. In alternative  
5 embodiments, a microprocessor may be included in apparatus 200 which can sense, monitor and control energy delivery, thus not requiring separate sensors.

[0059] With continued reference to Figure 3, some embodiments of apparatus 200 include guide catheter 220, or an alternative guide member as discussed further below. Guide catheter 220 is generally a flexible catheter along which catheter device 210 may be slidably  
10 advanced to a position for PFO treatment. Guide catheter 210 is configured to fit at least partially within a PFO and optionally through a PFO into the left atrium of the heart. Optionally, one or more radiopaque markers 224 may be included on guide catheter.

[0060] Guide catheter 220 may contain one or more expandable members 222 or other similar devices for expanding within the PFO to help bring the PFO tissues together, anchor  
15 catheter device to the PFO tissues, or both. As shown in Figure 3, for example, a "fish mouth" or two-prong expandable member 222 may be deployed within a PFO. When the two arms of the fish mouth separate, PFO-adjacent tissues are stretched laterally such that they tend to come together in the middle. In some embodiments, expandable members 222 may assist in PFO tissue apposition either while extending into the left atrium, while in other  
20 embodiments expandable members 22 do not extend into the left atrium.

[0061] Expandable member 222 may have any suitable configuration and may be constructed from any suitable materials. For example, expandable member 222 may be spring loaded, made of shape memory material, such as nitinol or spring stainless steel or the like. Alternatively, expandable member 222 may be expanded mechanically by one or more  
25 expansion members coupled with expandable member 222 and controlled via an actuator at the proximal end of guide catheter 220. During delivery of guide catheter 220, expandable member 222 reside within guide catheter 220. Guide catheter 220 may then be withdrawn to deploy expandable member 222 either within the PFO or within the left atrium to be drawn back into the PFO. In some embodiments, expandable member 222 has one or more pre-  
30 shaped or shapeable distal tips 223. Tips 223 may be used, for example, to help locate and cross the PFO. Tips 223 may also be used to contact a left atrial surface of the septum

primum or other PFO tissue, so that when the expandable member 222 is pulled proximally tips 223 help bring the PFO tissues together and/or anchor apparatus 200.

[0062] In some embodiments, one or more expandable members 222 may include or be coupled with one or more energy transmission members. For example, expandable member 222 may include one or more radiofrequency transmission members for monopolar or bipolar RF transmission. A fish mouth expandable member 222, for example, may include a bipolar RF transmission member on each prong of the fish mouth. In some embodiments, energy transmission members may be included in or coupled with both expandable member 222 and tissue apposition member 212. In any such embodiments, some portions of the energy transmission member(s) may be insulated, to prevent unwanted energy transmission to tissues. For example, in some embodiments a distal tip extending to contact a left atrial surface of PFO tissues may be insulated to prevent energy transmission from the tip.

[0063] Referring now to Figure 4, an alternative embodiment of a PFO-treatment apparatus 300 suitably includes a catheter device 310 having a tissue apposition member 312, radiopaque marker 326 and flexible isolation portion 328. For exemplary purposes only, this embodiment is shown having one energy transmission member 314, such as a monopolar RF transmission member. As shown, apparatus 300 may also include a guidewire 320, over which catheter device 310 may be advanced. Guidewire 320 includes a split, expandable portion 322, which may be released from catheter device 310 to expand within a PFO to bring PFO tissues together. Guidewire 320 also suitably includes a distal tip 323 for locating and crossing a PFO and/or for contacting a left atrial surface of the septum primum or other PFO tissue.

[0064] Apparatus 300 of Figure 4 may include any of the features described above in relation to Figure 3. In the embodiment in Figure 4, apparatus 300 does not include a guide catheter, but instead includes guidewire 320. Guidewire 320 may serve many or all of the functions of the guide catheter and expanding member described above in reference to Figure 3. Split portion 322 of guidewire 320 may be constructed of shape memory material or other suitable materials to allow it to expand when released from catheter device 310. Additionally, split portion 322 may include or be coupled with one or more energy transmission members instead of or in addition for energy transmission member(s) 314 coupled with tissue apposition member 312. Guidewire 320 may also include one or more distal tips 323, which again may be used to locate and cross a PFO and/or to help appose PFO

tissues. In some embodiments, tip 323 may also include or be coupled with one or more energy transmission members.

[0065] Referring now to Figures 5A and 5B, another embodiment of a PFO-treatment apparatus 400 suitably includes a catheter device 410 having a tissue apposition member 412, radiopaque markers 426 and flexible isolation portion 428. As shown, apparatus 400 may also include a guidewire 420, over which catheter device 410 may be advanced. Guidewire 420 includes a split, expandable portion 422, which may be released from catheter device 410 to expand within a PFO to bring PFO tissues together. Guidewire 420 also suitably includes a distal tip 423 for helping locate and cross the PFO and/or for contacting a left atrial surface of the septum primum or other PFO tissue to help bring the PFO tissues together. In this embodiment, catheter device 410 also includes a braided portion 430 which includes the proximally-disposed tissue apposition member 412 and a more distal energy transmission portion 432, the latter of which is coupled with energy transmission members 414. Tissue apposition member 412 and energy transmission portion 432 may be a unitary braided member, with tissue apposition member 412 configured to cover energy transmission portion 432 in a retracted position and to provide vacuum force application.

[0066] In use, catheter device 410 is typically advanced over guidewire 420 to a treatment location. Split portion 422 and optionally distal tip 423 are then used to help appose the tissues adjacent the PFO. Before, during or after retraction of guidewire 420, energy transmission portion 432 is retracted into tissue apposition member 412. PFO tissue is then brought together using tissue apposition member 412, and energy is transmitted to the tissues using energy transmission portion 432. In some embodiments, tissue apposition member 412 provides for application of vacuum energy to the tissues to suction the tissues at least partially into tissue apposition member 412, thus enhancing contact of the tissues with energy transmission portion 432. Energy transmission portion 432 may comprise, for example an electrode mesh material, while tissue apposition member 412 may comprise an elastic coated mesh or other material. Again, any features described above in reference to other embodiments may be applied to the embodiment shown in Figures 5A and 5B.

[0067] With reference now to Figure 6, another embodiment of a PFO-treatment apparatus 500 suitably includes a catheter device 510 having a tissue apposition member 512, energy transmission members 514, radiopaque marker 526 and flexible isolation portion 528. For simplicity, apparatus 500 is shown without a guide catheter or guidewire, though either may

be included. In this embodiment, tissue apposition member 512 includes ribs or "bellows" 540 to facilitate placement and/or alignment of tissue apposition member 512 relative to the septal wall tissues to be treated and/or to enhance adherence of apparatus 500 to the septal wall. For example, ribs 540 may allow catheter device 510 to move relatively freely relative to tissue apposition member 512, without displacing tissue apposition member 512 from the PFO tissues.

[0068] Referring now to Figure 7, another embodiment of a PFO-treatment apparatus 600 suitably includes a catheter device 610 having a tissue apposition member 612, energy transmission members 614, radiopaque marker 626 and flexible isolation portion 628. Apparatus 600 is shown without a guide catheter or guidewire, though either may be included. In this embodiment, tissue apposition member 612 includes multiple struts 650 covered by a covering 652, which may comprise a polymeric covering or any other suitable material. Struts 650 may be self-expanding or may open via a mechanical opening actuator coupled with struts 650, such as opening apparatus used to open an umbrella. Energy transmission members 614 are coupled with self-expanding struts 650 on the internal surface of tissue apposition member 612, so as to contact PFO tissue that is pulled within tissue apposition member 612, such as by applied vacuum force and/or by blood pressure from the left atrium.

[0069] Figures 8A-8E demonstrate a method for treating a PFO according to one embodiment of the present invention. It should be emphasized that this is merely one possible embodiment, and that many alternative methods are contemplated. For example, steps may be modified, repeated, added or deleted from the method, the order of steps may be changed, and/or the like, without departing from the scope of the invention as defined by the appended claims. Therefore, the foregoing description should not be interpreted to limit the scope of the invention in any way.

[0070] That being said, in one embodiment, a PFO treatment method includes advancing a guide catheter 720 through the PFO, between tissues T adjacent the PFO, the guide catheter 720 containing an expandable member (Figure 8A). Guide catheter 720 is then retracted (proximally pointing arrow) to expose expanding member 722 (Figure 8B). Expanding member 722 may be exposed/expanded within the PFO, or may alternatively be exposed/expanded within the left atrium and pulled back into the tunnel of the PFO. Expanding member 722 may also include one or more distal tips 723, which may help to

locate the PFO, cross the PFO, appose the tissues T and/or to anchor guide catheter 720 to the tissues T.

[0071] Once guide catheter 720 is in place and expandable member 722 is deployed, catheter device 710 may be advanced over guide catheter 720 to a position for treatment of the PFO (Figure 8C). Catheter device 710 typically includes a tissue apposition member 712 (shown here in cross-section for clarity) and one or more energy transmission members 714. Suction may be applied using tissue apposition member 712, left atrial pressure may be used, or both, to bring tissues T adjacent the PFO together (Figure 8D). Once tissue apposition member 712 is placed and/or activated, guide catheter 720 and expandable member 722 may be removed through catheter device 710, leaving the tissues T apposed and catheter device in place, as in Figure 8D. Alternatively, guide catheter 720 and expandable member 722 may be left in place during a first welding to close the majority of the PFO and then removed. The small patent portions of the PFO remaining after the guide catheter 720 and expandable member 722 are removed may then be closed by a second weld or may be left open and allowed to close via healing or scarring. Tissue apposition member 712 may be used to hold tissues T together before, during and/or after energy transmission members 714 weld the tissues T together. Such holding of the tissues together and application of energy to weld the tissues may be performed for any suitable time, such as for less than one second to many minutes. Once a sufficient amount of energy has been applied to the tissues T to acutely close the PFO, catheter device 710 is removed, leaving a closed PFO, as in Figure 8E.

[0072] As mentioned above, the foregoing method may be altered in any number of ways without departing from the scope of the invention. In some embodiments, for example, tissues adjacent the PFO are brought at least partially together and energy is applied to the tissues to acutely close the PFO with fewer steps and/or fewer device components than just described. For example, application of suction to appose tissues is not required in all embodiments. Furthermore, a variety of different types of energy may be applied to the tissues from a variety of differently configured energy transmission devices. In some embodiments, one or more of the steps described above may be repeated one or more times, such as by repeating a tissue welding step. The above description, therefore, is provided for exemplary purposes only.

[0073] Although the foregoing description is complete and accurate, it has described only exemplary embodiments of the invention. Various changes, additions, deletions and the like



may be made to one or more embodiments of the invention without departing from the scope of the invention. Additionally, different elements of the invention could be combined to achieve any of the effects described above. Thus, the description above is provided for exemplary purposes only and should not be interpreted to limit the scope of the invention as

5 set forth in the following claims.

WHAT IS CLAIMED IS:

- 1           1.       A method of treating a patent foramen ovale in a heart, the method  
2 comprising:  
3           advancing a catheter device to a position in the heart for treating the patent  
4 foramen ovale; and  
5           applying energy to tissues adjacent the patent foramen ovale with the catheter  
6 device to substantially close the patent foramen ovale acutely.
- 1           2.       A method as in claim 1, further comprising bringing the tissues at least  
2 partially together, using the catheter device.
- 1           3.       A method as in claim 2, wherein the tissues are brought together before  
2 applying the energy.
- 1           4.       A method as in claim 2, further comprising holding the tissues together  
2 while applying the energy.
- 1           5.       A method as in claim 4, further comprising holding the tissues together  
2 after the energy has been applied.
- 1           6.       A method as in claim 5, further comprising cooling the tissues after the  
2 energy has been applied.
- 1           7.       A method as in claim 2, wherein bringing the tissues at least partially  
2 together comprises contacting the tissues with a tissue covering member adjacent a distal end  
3 of the catheter device.
- 1           8.       A method as in claim 7, wherein contacting the tissues with the tissue  
2 covering member causes blood pressure in a left atrium of the heart to bring the tissues at  
3 least partially together.
- 1           9.       A method as in claim 8, wherein bringing the tissues together further  
2 comprises applying vacuum force to the tissues with the tissue covering member.
- 1           10.      A method as in claim 1, further comprising cooling the tissues after the  
2 energy has been applied.

1           11.     A method as in claim 10, further comprising:  
2           bringing the tissues at least partially together, using the catheter device; and  
3           holding the tissues together while applying the energy and while cooling the  
4 tissues.

1           12.     A method as in claim 1, wherein advancing the catheter comprises  
2 positioning a distal end of the catheter in a right atrium of the heart.

1           13.     A method as in claim 1, wherein advancing comprises advancing the  
2 catheter over a guide catheter extending into the patent foramen ovale.

1           14.     A method as in claim 13, wherein the guide catheter extends through  
2 the patent foramen ovale into a left atrium of the heart.

1           15.     A method as in claim 13, further comprising retracting a sheath portion  
2 of the guide catheter to expose an expanding member within the patent foramen ovale, the  
3 exposed expanding member bringing the tissues adjacent the patent foramen ovale at least  
4 partially together.

1           16.     A method as in claim 15, wherein the exposed expanding member  
2 provides lateral force to the tissues adjacent the patent foramen ovale.

1           17.     A method as in claim 16, wherein the exposed expanding member  
2 provides the lateral force without extending into the left atrium of the heart.

1           18.     A method as in claim 15, wherein the exposed expanding member, by  
2 contacting the tissues, aligns a cross-sectional center of the catheter device approximately  
3 with a cross-sectional center of the patent foramen ovale.

1           19.     A method as in claim 15, further comprising:  
2           contacting a left atrial surface of at least one of a septum primum and a septum  
3 secundum with a distal portion of the expanding member; and  
4           retracting the expanding member to bring the tissues adjacent the patent  
5 foramen ovale together.

1           20.     A method as in claim 19, further including retracting the expanding  
2 member to a position within the guide catheter.

1           21.     A method as in claim 20, further comprising removing the guide  
2 catheter through the catheter device after the expanding member is retracted within the guide  
3 catheter.

1           22.     A method as in claim 21, wherein the guide catheter is removed before  
2 applying the energy.

1           23.     A method as in claim 1, wherein advancing comprises advancing the  
2 catheter over a guidewire extending through the patent foramen ovale, wherein the guidewire  
3 includes an expanding portion along its length for expanding within the patent foramen ovale.

1           24.     A method as in claim 23, further comprising:  
2           contacting a left atrial surface of at least one of a septum primum and a septum  
3 secundum with a distal portion of the guidewire; and  
4           retracting the guidewire to bring the tissues adjacent the patent foramen ovale  
5 together.

1           25.     A method as in claim 1, wherein applying energy comprises applying  
2 at least one of radiofrequency energy, cryogenic energy, resistive heat energy, ultrasound  
3 energy, microwave energy and laser energy.

1           26.     A method as in claim 25, wherein at least one of monopolar  
2 radiofrequency energy and bipolar radiofrequency energy is applied.

1           27.     A method as in claim 25, wherein applying energy comprises  
2 energizing a single conductive member of the catheter device.

1           28.     A method as in claim 25, wherein applying energy comprises  
2 energizing multiple conductive members of the catheter device.

1           29.     A method as in claim 1, wherein applying energy comprises denaturing  
2 collagen in the tissues.

1           30.     A method as in claim 1, further comprising monitoring an amount of  
2 energy applied to the tissues.

1           31.     A method as in claim 30, wherein monitoring the amount of energy  
2 comprises monitoring a temperature of the tissues.

1           32.     A method as in claim 30, wherein monitoring the amount of energy  
2 comprises monitoring an impedance of the tissues.

1           33.     A method as in claim 30, further comprising determining when a  
2 sufficient amount of energy has been applied to the tissues to substantially close the patent  
3 foramen ovale acutely.

1           34.     A method as in claim 33, further comprising discontinuing the  
2 application of energy when the sufficient amount of energy has been applied.

1           35.     A method as in claim 1, further comprising directly visualizing the  
2 patent foramen ovale and the tissues using at least one visualization device coupled with the  
3 catheter device.

1           36.     A method of treating a patent foramen ovale in a heart, the method  
2 comprising:  
3           advancing a catheter device to a position in the heart for treating the patent  
4 foramen ovale; and  
5           removing energy from tissues adjacent the patent foramen ovale with the  
6 catheter device to substantially close the patent foramen ovale acutely.

1           37.     A method as in claim 36, further comprising bringing the tissues at  
2 least partially together, using the catheter device.

1           38.     A method as in claim 37, wherein the tissues are brought together  
2 before removing the energy.

1           39.     A method as in claim 37, further comprising holding the tissues  
2 together while removing the energy.

1           40.     A method as in claim 39, further comprising holding the tissues  
2 together after the energy has been applied.

1           41.     A method as in claim 37, wherein bringing the tissues at least partially  
2 together comprises contacting the tissues with a tissue covering member adjacent a distal end  
3 of the catheter device.

1           42.     A method as in claim 41, wherein contacting the tissues with the tissue  
2 covering member causes blood pressure in a left atrium of the heart to bring the tissues at  
3 least partially together.

1           43.     A method as in claim 42, wherein bringing the tissues together further  
2 comprises applying vacuum force to the tissues with the tissue covering member.

1           44.     A method as in claim 36, wherein advancing the catheter comprises  
2 positioning a distal end of the catheter in a right atrium of the heart.

1           45.     A method as in claim 36, wherein advancing comprises advancing the  
2 catheter over a guide catheter extending into the patent foramen ovale.

1           46.     A method as in claim 45, wherein the guide catheter extends through  
2 the patent foramen ovale into a left atrium of the heart.

1           47.     A method as in claim 45, further comprising retracting a sheath portion  
2 of the guide catheter to expose an expanding member within the patent foramen ovale, the  
3 exposed expanding member bringing the tissues adjacent the patent foramen ovale at least  
4 partially together.

1           48.     A method as in claim 47, wherein the exposed expanding member  
2 provides lateral force to the tissues adjacent the patent foramen ovale.

1           49.     A method as in claim 48, wherein the exposed expanding member  
2 provides the lateral force without extending into the left atrium of the heart.

1           50.     A method as in claim 47, wherein the exposed expanding member, by  
2 contacting the tissues, aligns a cross-sectional center of the catheter device approximately  
3 with a cross-sectional center of the patent foramen ovale.

1           51.     A method as in claim 47, further comprising:

2           contacting a left atrial surface of at least one of a septum primum and a septum  
3 secundum with a distal portion of the expanding member; and  
4           retracting the expanding member to bring the tissues adjacent the patent  
5 foramen ovale together.

1           52.    A method as in claim 51, further including retracting the expanding  
2 member to a position within the guide catheter.

1           53.    A method as in claim 52, further comprising removing the guide  
2 catheter through the catheter device after the expanding member is retracted within the guide  
3 catheter.

1           54.    A method as in claim 53, wherein the guide catheter is removed before  
2 removing the energy.

1           55.    A method as in claim 36, wherein advancing comprises advancing the  
2 catheter over a guidewire extending through the patent foramen ovale, wherein the guidewire  
3 includes an expanding portion along its length for expanding within the patent foramen ovale.

1           56.    A method as in claim 55, further comprising:  
2           contacting a left atrial surface of at least one of a septum primum and a septum  
3 secundum with a distal portion of the guidewire; and  
4           retracting the guidewire to bring the tissues adjacent the patent foramen ovale  
5 together.

1           57.    A method as in claim 36, wherein removing energy comprises  
2 applying at least one cryogenic energy member to the tissues.

1           58.    A method as in claim 36, further comprising monitoring an amount of  
2 energy removed from the tissues.

1           59.    A method as in claim 58, wherein monitoring the amount of energy  
2 comprises monitoring a temperature of the tissues.

1           60.    A method as in claim 58, wherein monitoring the amount of energy  
2 comprises monitoring an impedance of the tissues.

1           61.     A method as in claim 58, further comprising determining when a  
2 sufficient amount of energy has been removed from the tissues to substantially close the  
3 patent foramen ovale acutely.

1           62.     A method as in claim 61, further comprising discontinuing the  
2 application of energy when the sufficient amount of energy has been removed.  
3

1           63.     A method as in claim 36, further comprising directly visualizing the  
2 patent foramen ovale and the tissues using at least one visualization device coupled with the  
3 catheter device.

1           64.     Apparatus for treating a patent foramen ovale in a heart, the apparatus  
2 comprising:  
3           a catheter device having a proximal end and a distal end; and  
4           at least one energy transmission member adjacent the distal end for applying  
5 energy to or removing energy from tissues adjacent the patent foramen ovale to substantially  
6 close the patent foramen ovale acutely.

1           65.     Apparatus as in claim 64, further comprising at least one tissue  
2 apposition member adjacent the distal end for at least partially bringing together the tissues.

1           66.     Apparatus as in claim 65, wherein the at least one energy transmission  
2 member is coupled with the at least one tissue apposition member.

1           67.     Apparatus as in claim 66, wherein the at least one energy transmission  
2 member is movable relative to the at least one tissue apposition member.

1           68.     Apparatus as in claim 65, wherein the at least one tissue apposition  
2 member comprises a tissue covering member.

1           69.     Apparatus as in claim 68, wherein the tissue covering member covers  
2 the patent foramen ovale to allow blood pressure in a left atrium of the heart to bring the  
3 tissues together.



1           70.     Apparatus as in claim 68, wherein the tissue covering member  
2 comprises at least one suction member for applying vacuum force to the tissues to bring the  
3 tissues together.

1           71.     Apparatus as in claim 68, wherein the tissue covering member is  
2 expandable from a first delivery dimension to a second treatment dimension.

1           72.     Apparatus as in claim 68, further comprising a flexible isolation  
2 portion disposed between the tissue covering member and the catheter device to prevent  
3 unwanted movement of the tissue covering member during use.

1           73.     Apparatus as in claim 68, wherein the at least one energy transmission  
2 member is coupled with the tissue covering member.

1           74.     Apparatus as in claim 64, further comprising a guide member for  
2 advancing through the patent foramen ovale, wherein the catheter device is slidably disposed  
3 over the guide member.

1           75.     Apparatus as in claim 74, wherein the guide member comprises:  
2 a guide catheter; and  
3 at least one expandable member disposed within the guide catheter, wherein  
4 the guide catheter is retractable to expose the expandable member to allow it to expand  
5 within the patent foramen ovale.

1           76.     Apparatus as in claim 75, wherein the expandable member comprises  
2 at least two members that expand apart to provide lateral force to the tissues adjacent the  
3 patent foramen ovale.

1           77.     A method as in claim 76, wherein the exposed expanding member  
2 provides the lateral force without extending into the left atrium of the heart.

1           78.     Apparatus as in claim 75, wherein the expandable member comprises a  
2 spring loaded member.

1           79.     Apparatus as in claim 75, wherein the expandable member comprises a  
2 shape memory material.

1           80.     Apparatus as in claim 74, wherein the guide member comprises a  
2 guidewire divided along a portion of its length, the divided portion comprising expandable  
3 shape memory material.

1           81.     Apparatus as in claim 74, wherein the guide member comprises at least  
2 one tip for contacting a left atrial surface of the tissues adjacent the patent foramen ovale.

1           82.     Apparatus as in claim 81, wherein the at least one tip is conformable to  
2 the left atrial surface.

1           83.     Apparatus as in claim 81, wherein the guide member is retractable to  
2 engage the at least one tip with the left atrial surface.

1           84.     Apparatus as in claim 74, wherein the guide member comprises at least  
2 one of the at least one energy transmission member.

1           85.     Apparatus as in claim 84, wherein the guide member comprises an  
2 expandable member for expanding within the PFO, and wherein the expandable member  
3 comprises at least one radiofrequency energy transmission member.

1           86.     Apparatus as in claim 64, wherein the at least one energy transmission  
2 member transmits at least one of radiofrequency energy, cryogenic energy, resistive heat  
3 energy, ultrasound energy, microwave energy and laser energy.

1           87.     Apparatus as in claim 86, wherein the at least one energy transmission  
2 member comprises at least one monopolar radiofrequency transmission member.

1           88.     Apparatus as in claim 86, wherein the at least one energy transmission  
2 member comprises at least two bipolar radiofrequency transmission members.

1           89.     Apparatus as in claim 86, wherein the at least one energy transmission  
2 member comprises at least one curved radiofrequency transmission member.

1           90.     Apparatus as in claim 86, wherein the at least one energy transmission  
2 member comprises at least one of a mesh material and a braid material.

1           91.     Apparatus as in claim 64, wherein the at least one energy transmission  
2 member comprises a guide member for advancing through the patent foramen ovale.

1           92.     Apparatus as in claim 91, wherein the guide member includes at least  
2 one expandable portion for expanding within the patent foramen ovale to at least partially  
3 bring together the tissues adjacent the patent foramen ovale.

1           93.     Apparatus as in claim 64, further comprising at least one sensor  
2 coupled with the catheter device for sensing an amount of energy delivered to the tissues by  
3 the at least one energy transmission member.

1           94.     Apparatus as in claim 93, wherein the at least one sensor is selected  
2 from the group consisting of an infrared sensing device, thermistors and thermocouples.

1           95.     Apparatus as in claim 93, further comprising a microprocessor coupled  
2 with the at least one sensor for processing sensed data to determine when the amount of  
3 delivered energy has reached a desired amount of energy.

1           96.     Apparatus as in claim 64, further comprising a microprocessor coupled  
2 with the catheter device for sensing and controlling energy transmission by the energy  
3 transmission member.

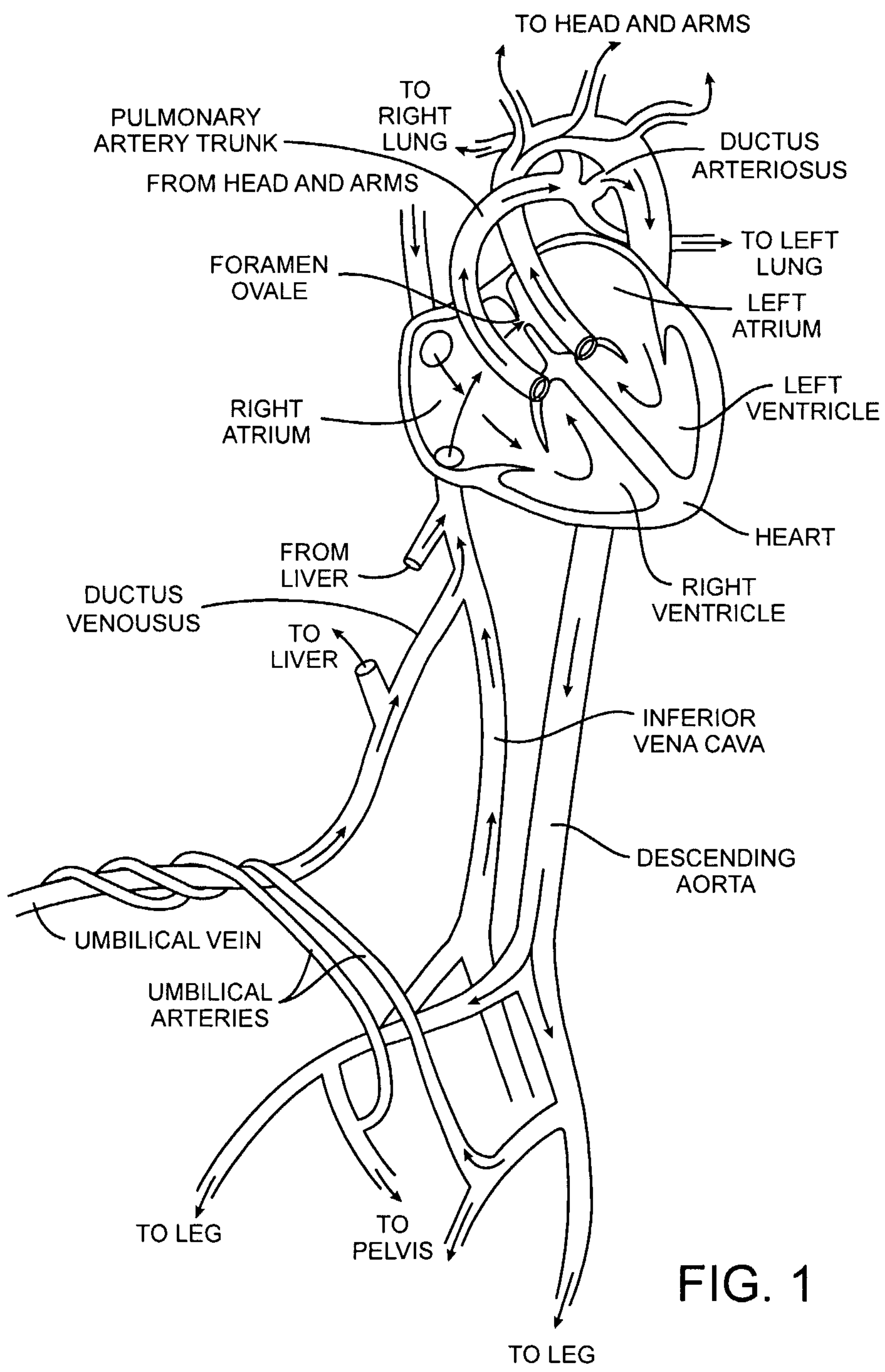

FIG. 1

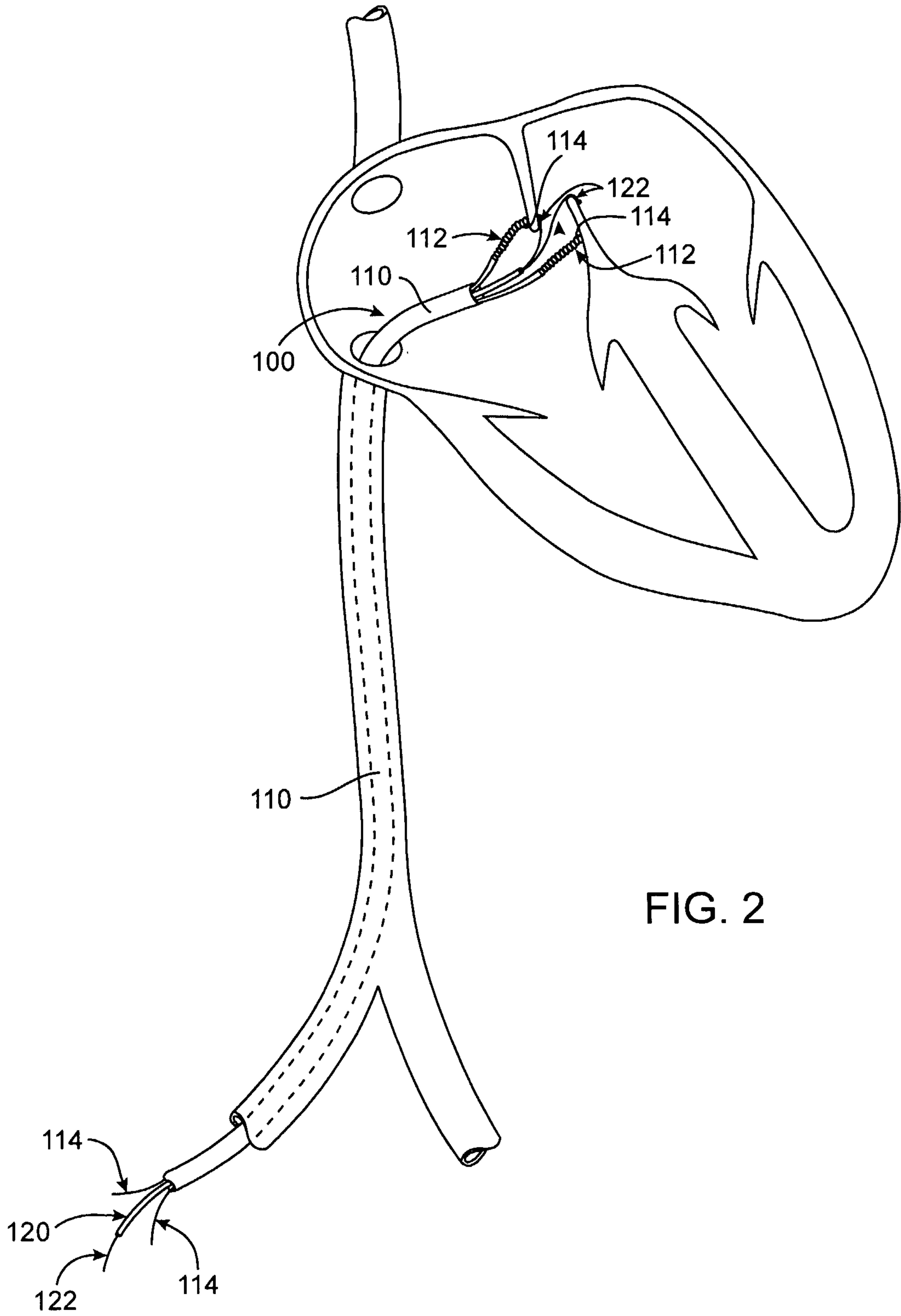

FIG. 2

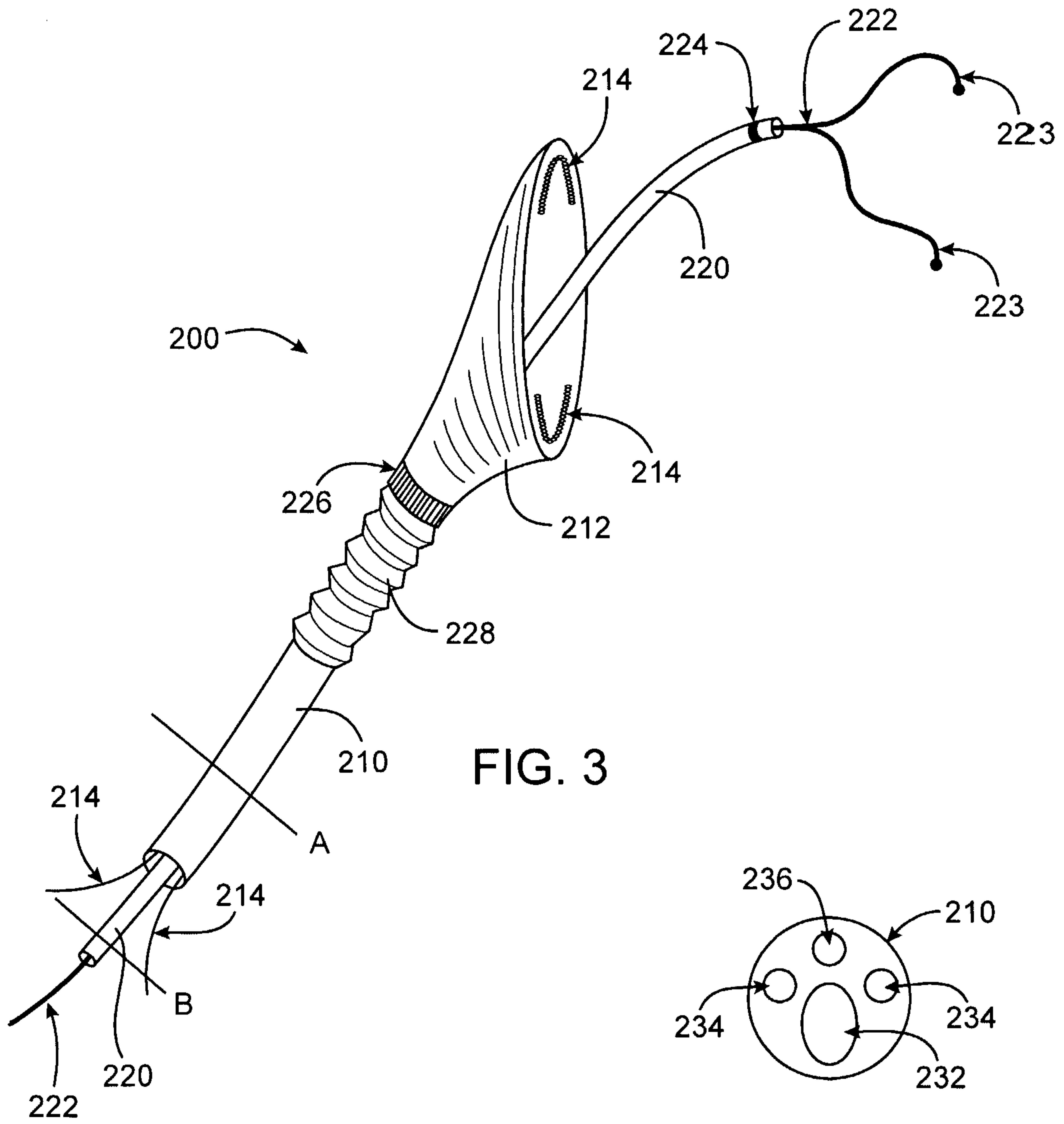

FIG. 3

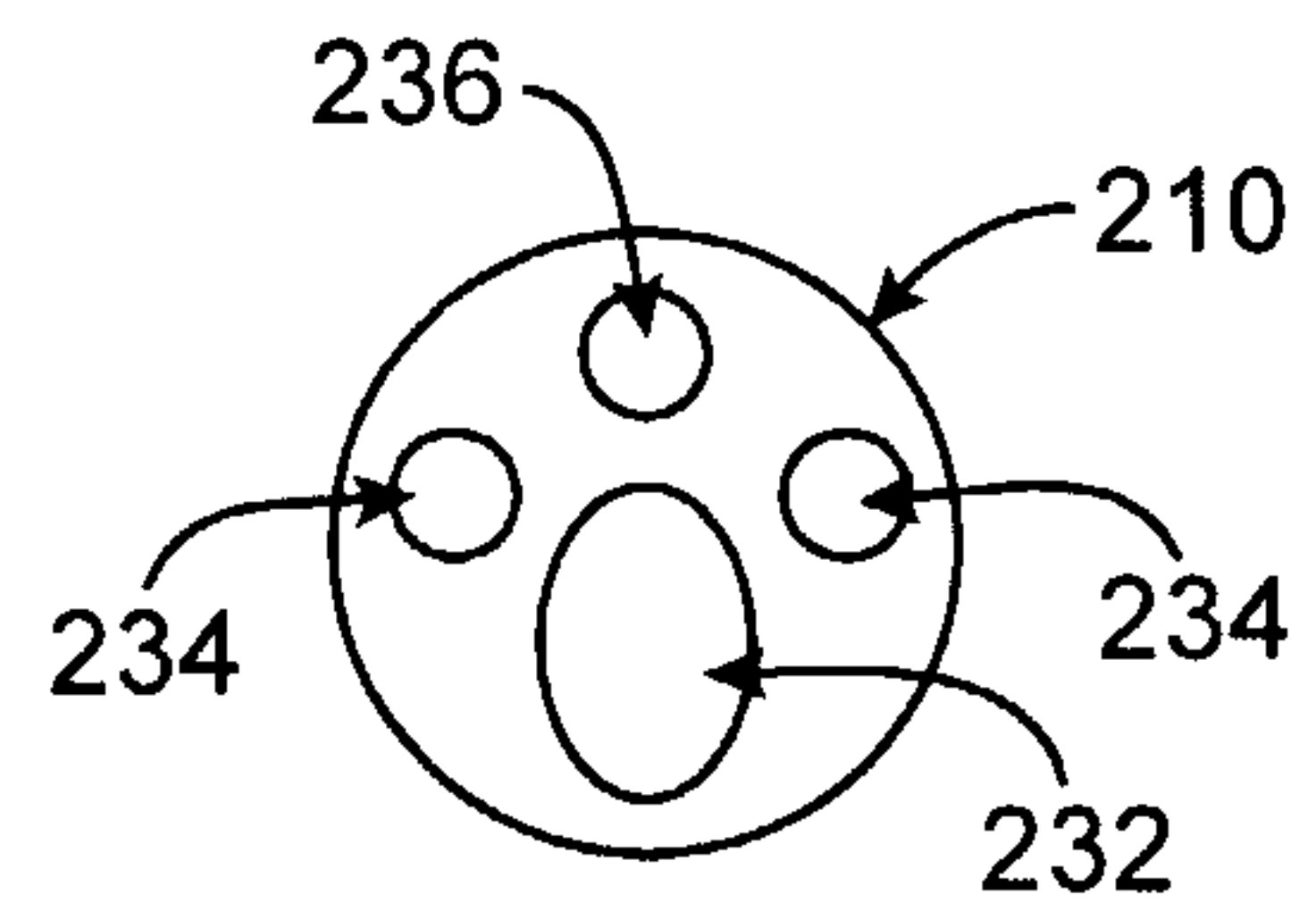

FIG. 3A

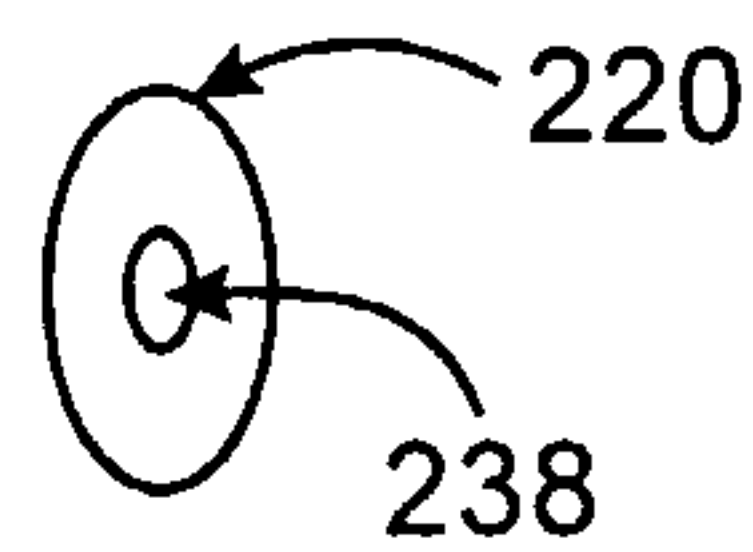

FIG. 3B

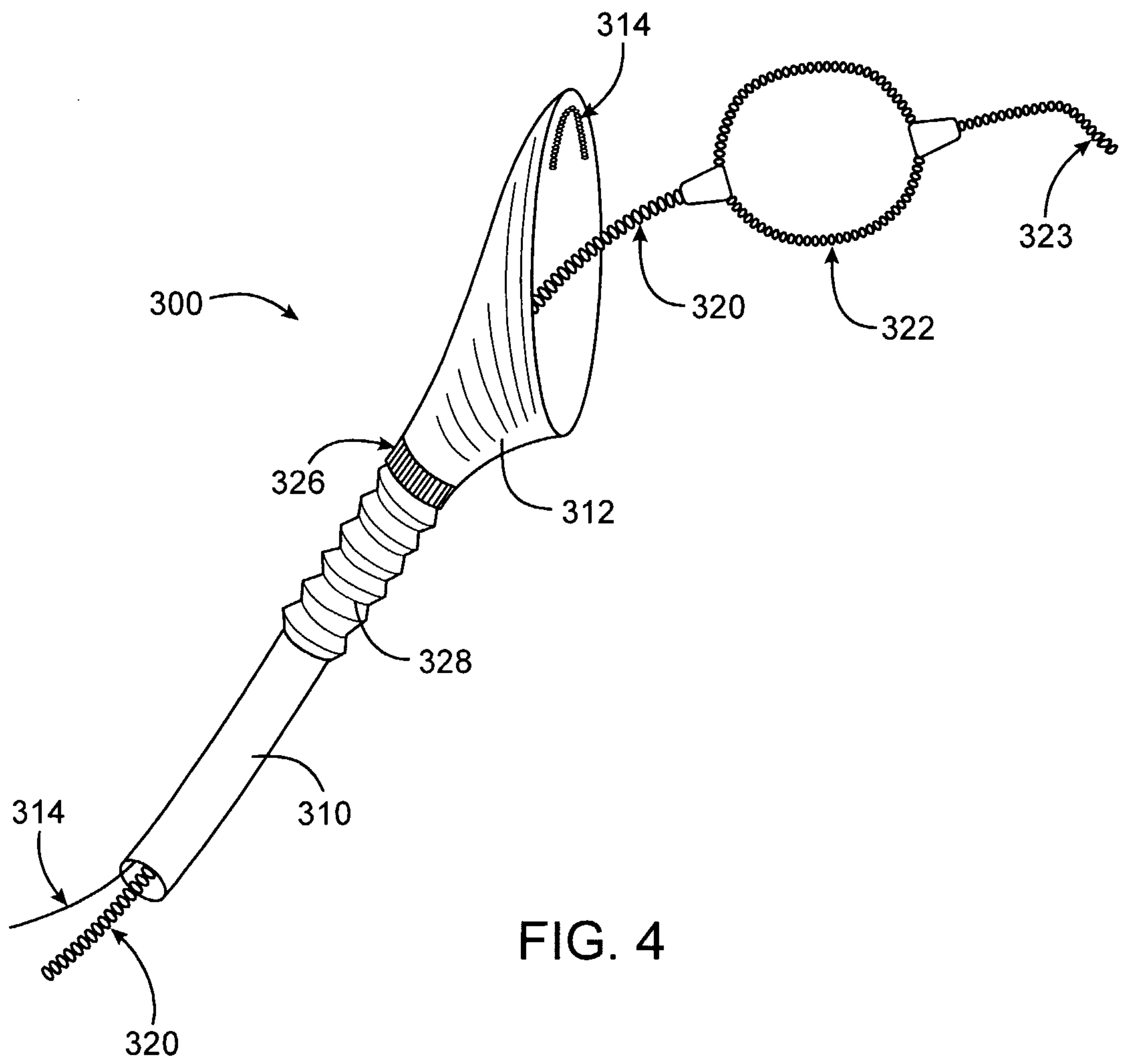

FIG. 4

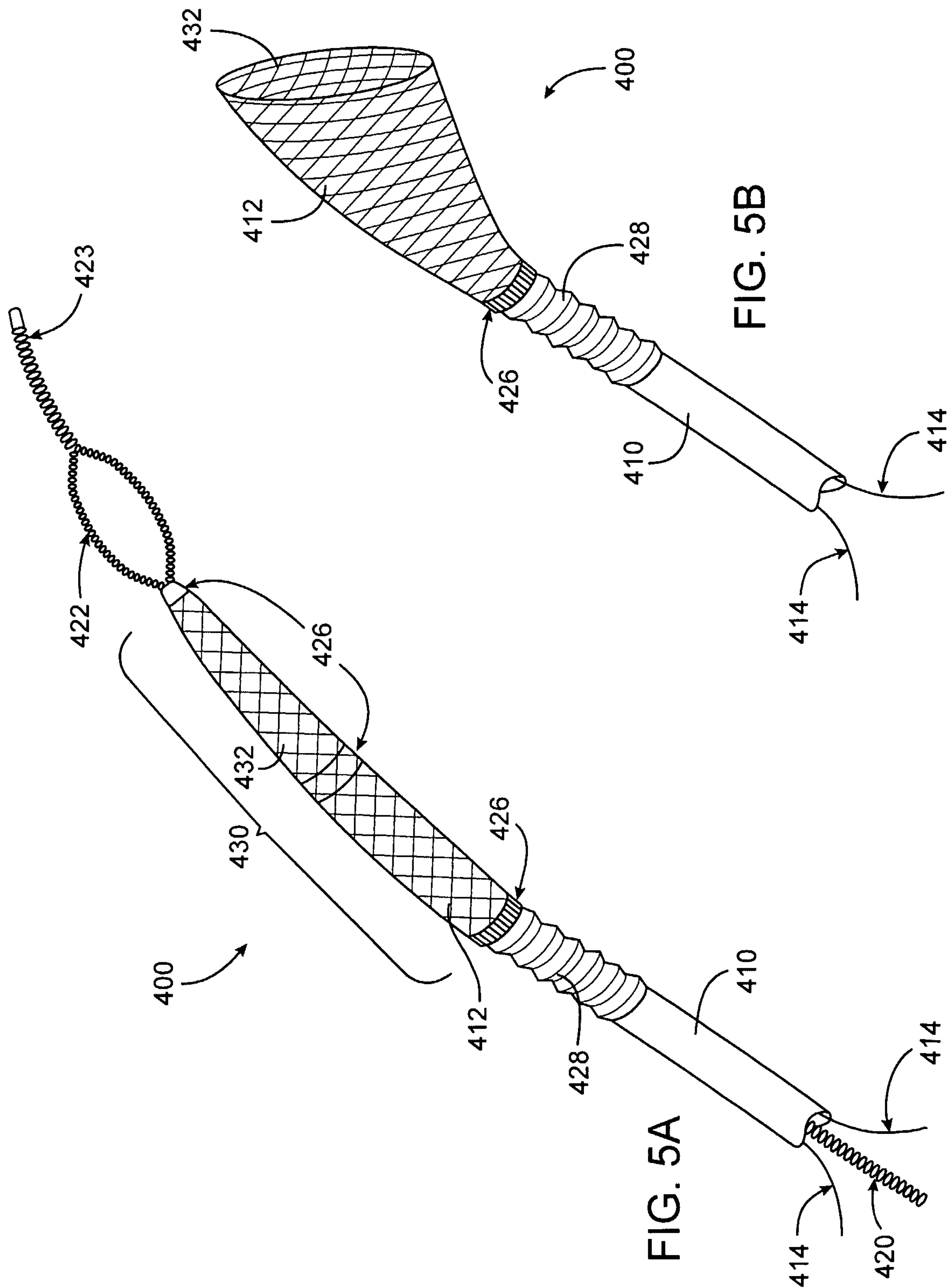

FIG. 5B

FIG. 5A



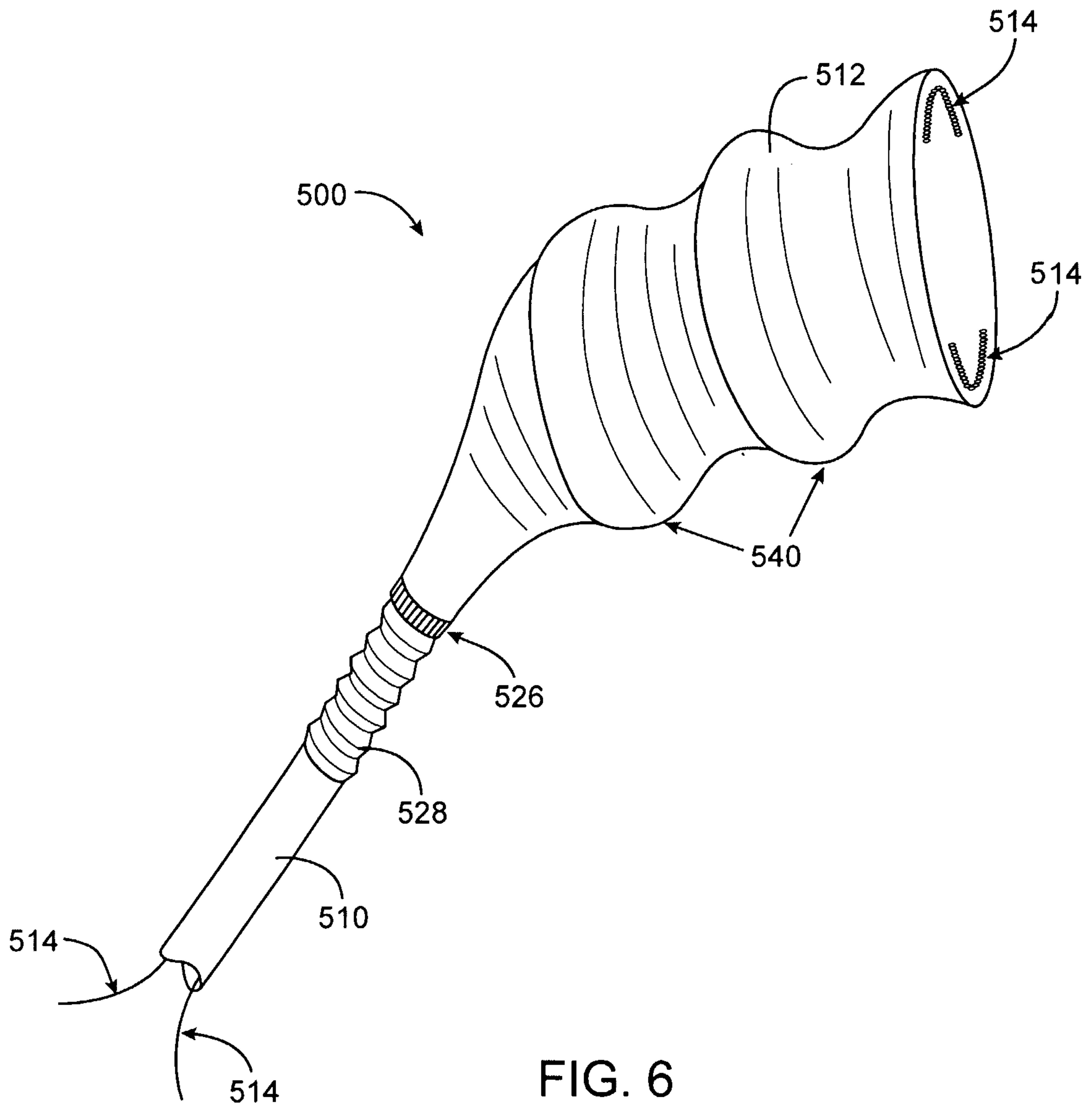

FIG. 6

7 / 9

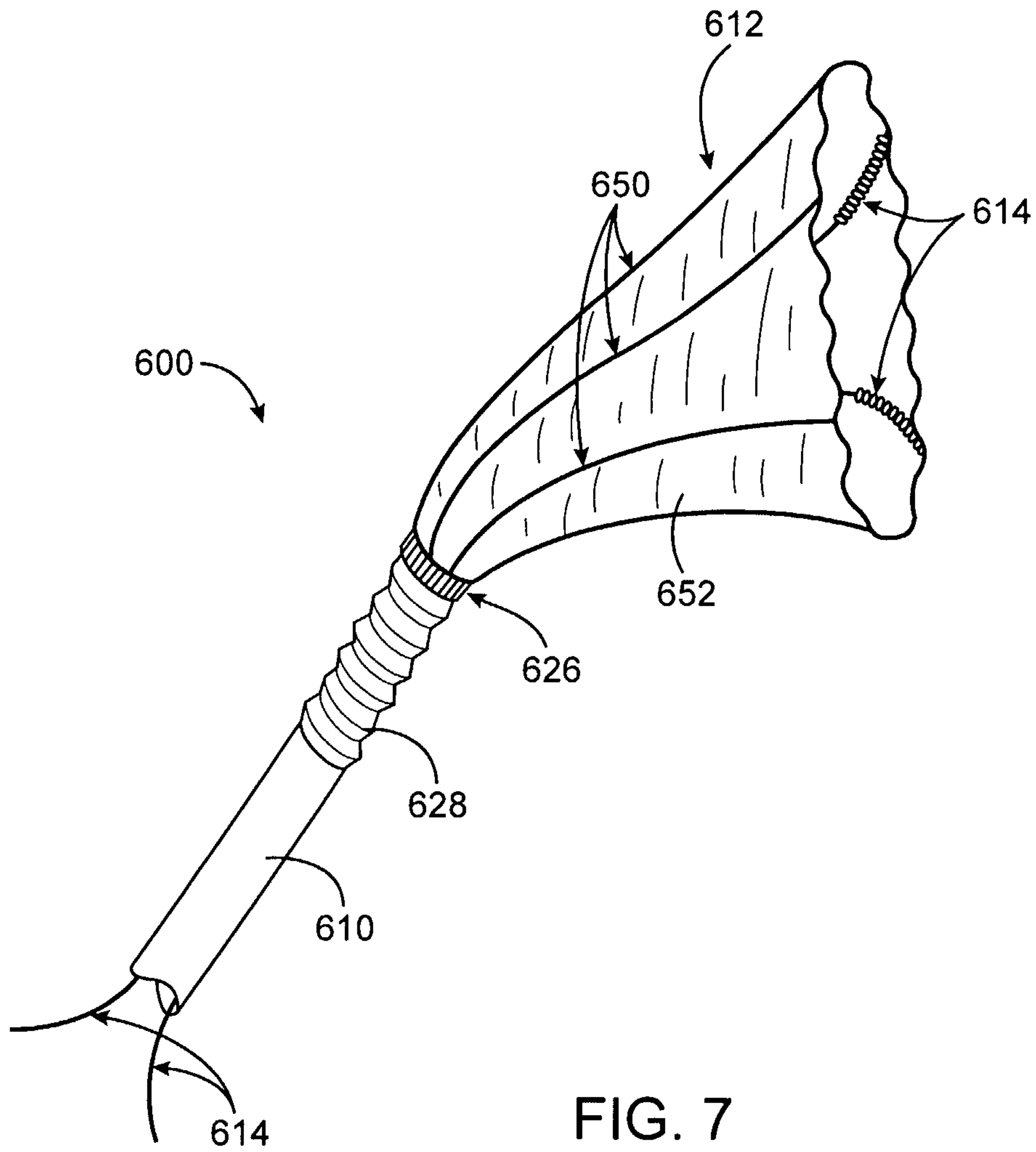

FIG. 7

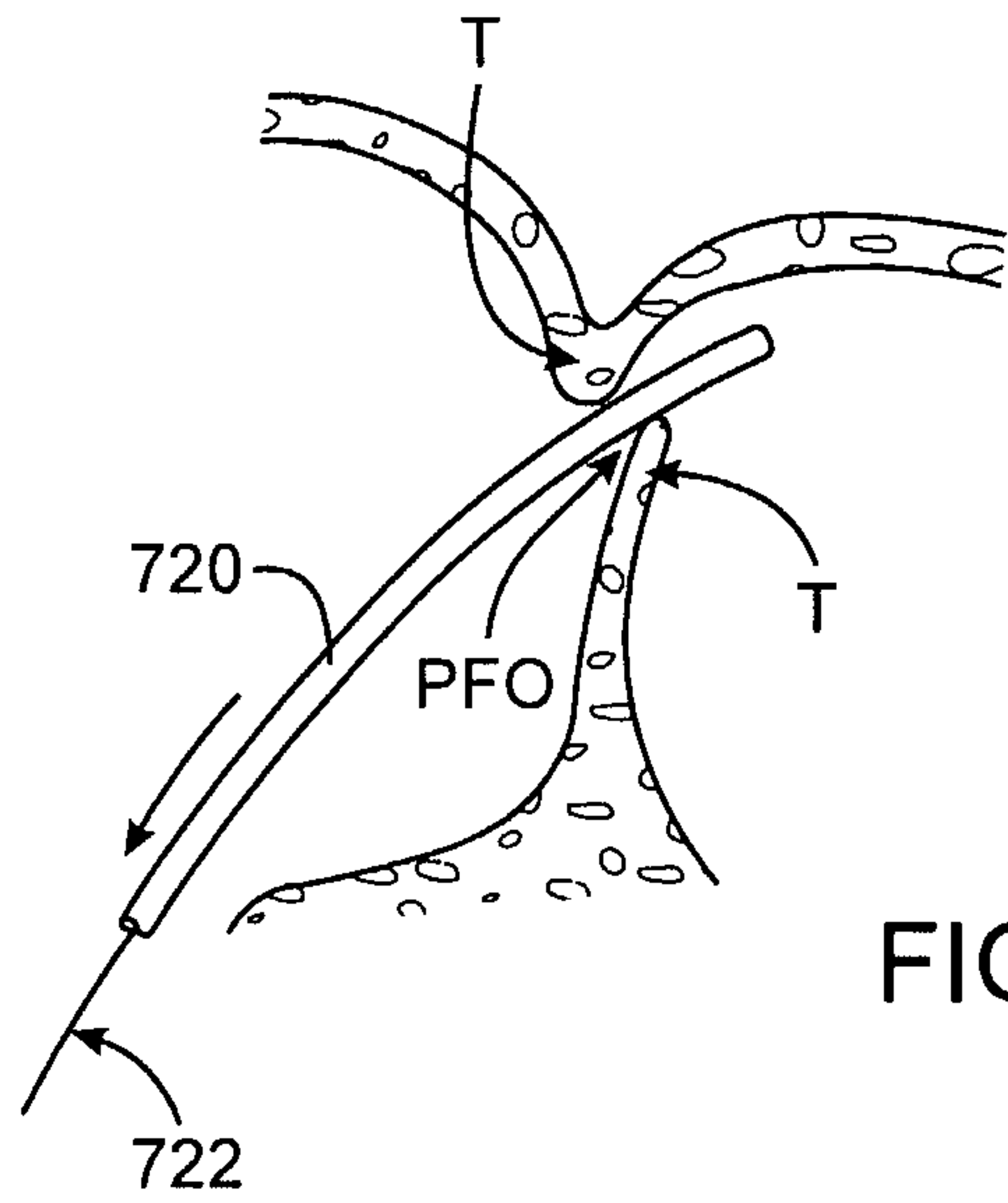

FIG. 8A

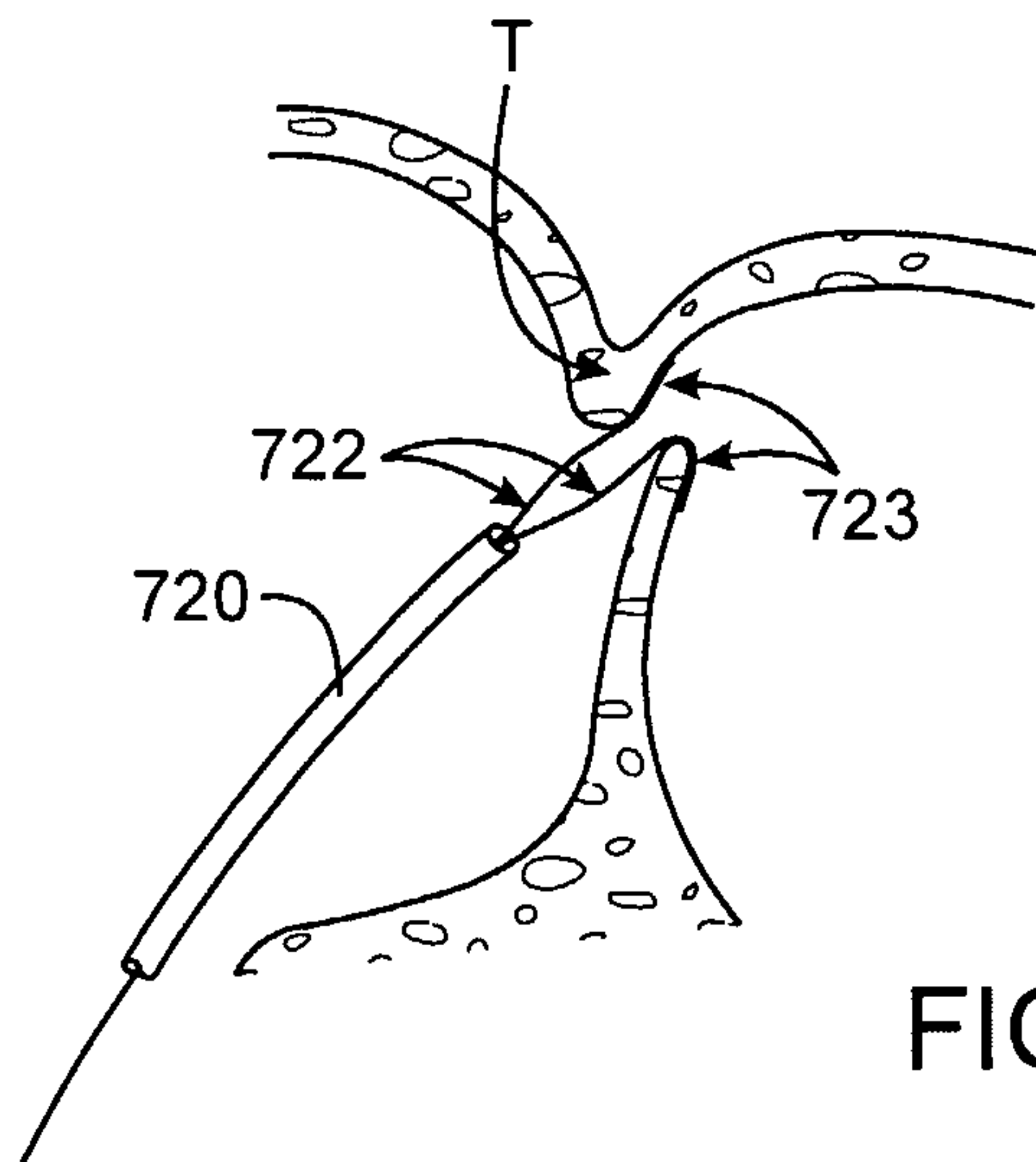

FIG. 8B

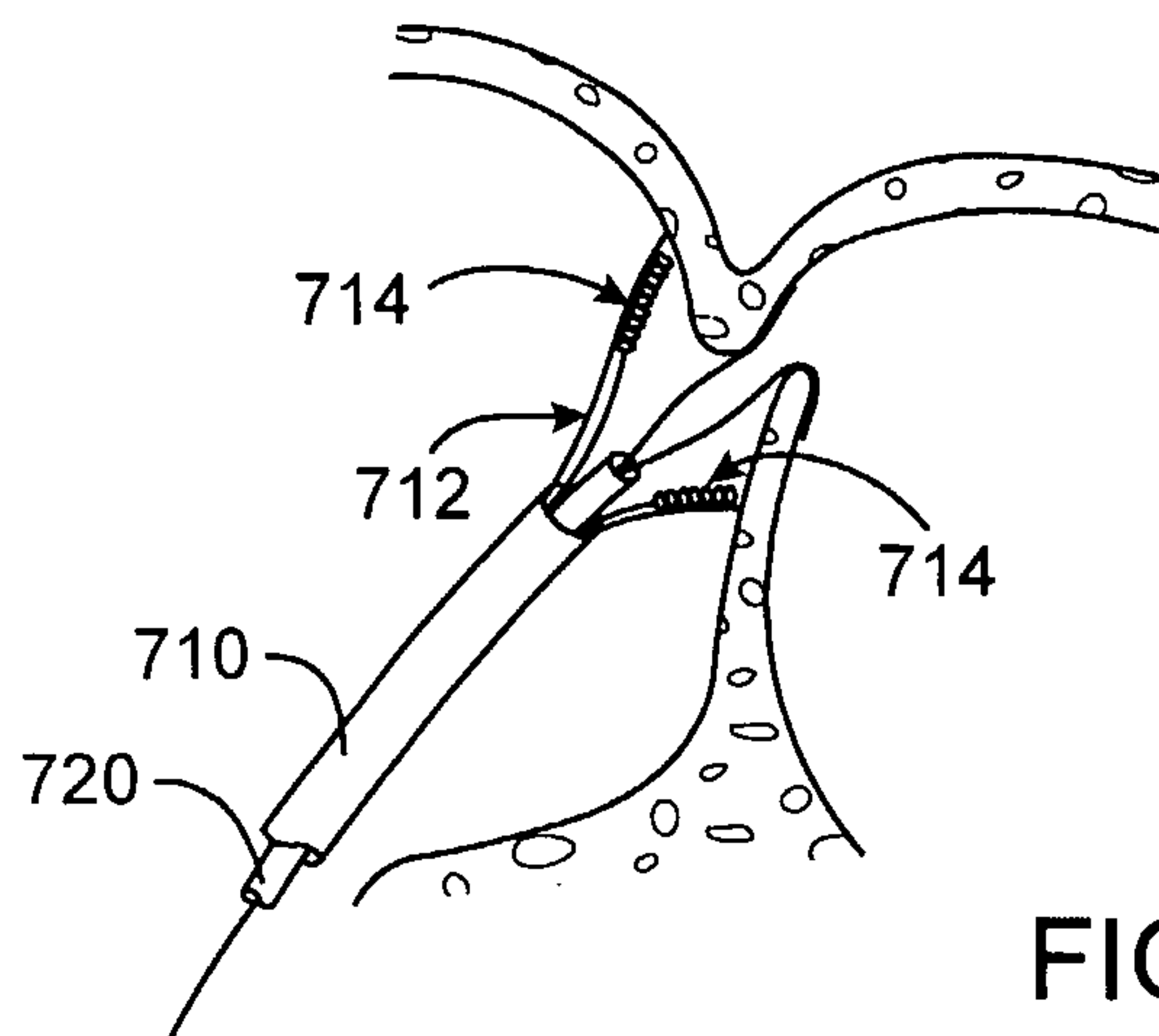

FIG. 8C

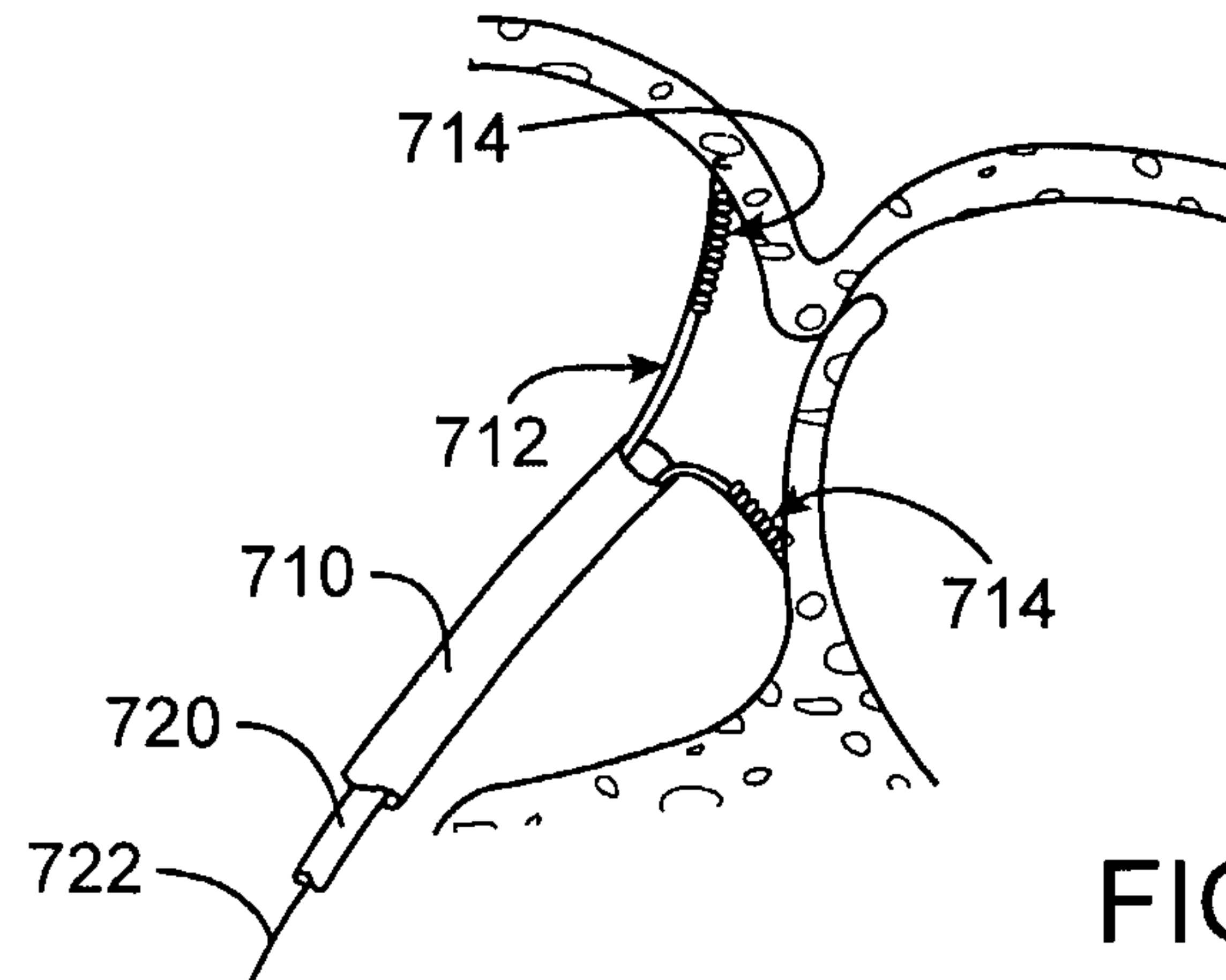

FIG. 8D

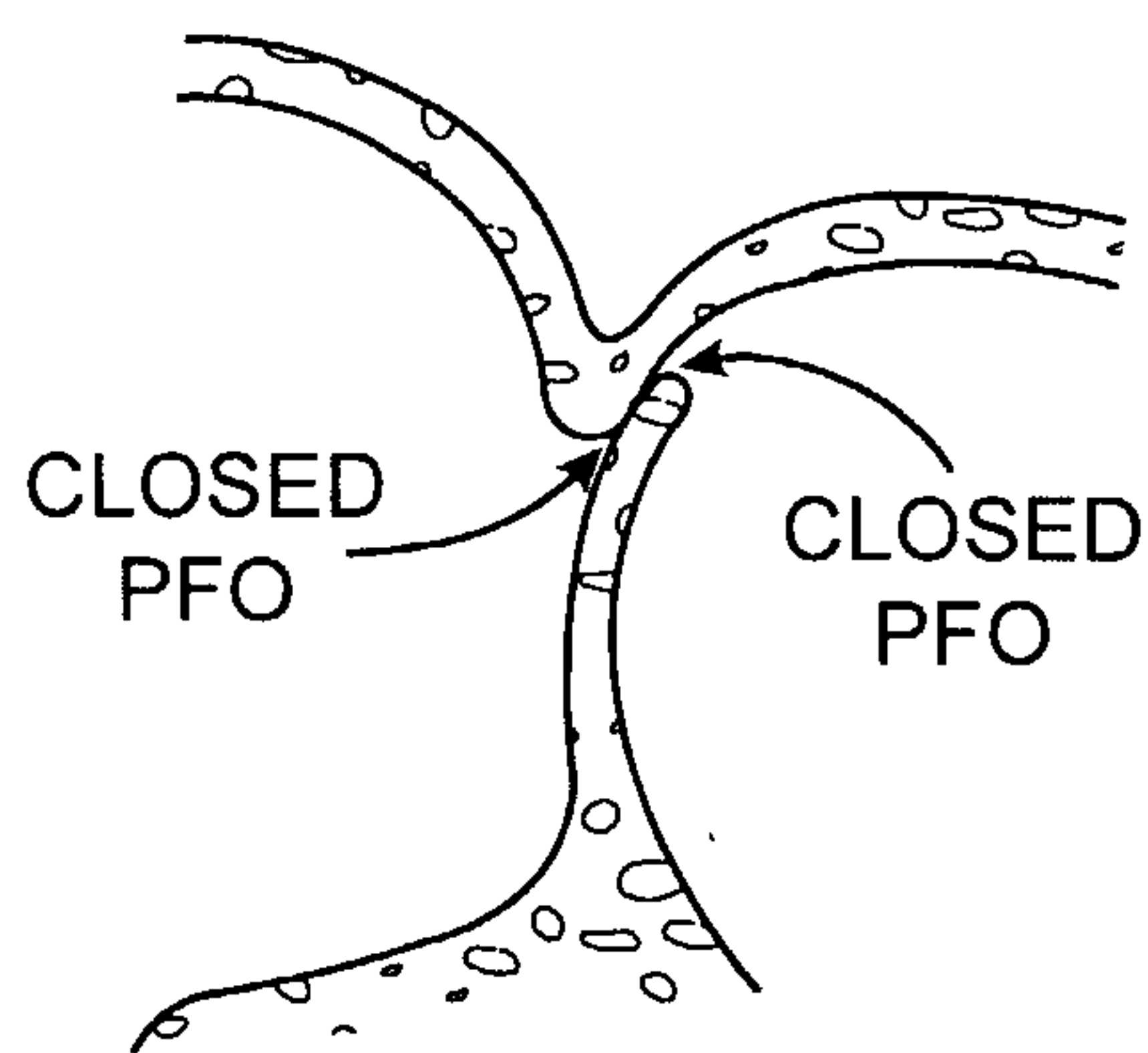

FIG. 8E

