

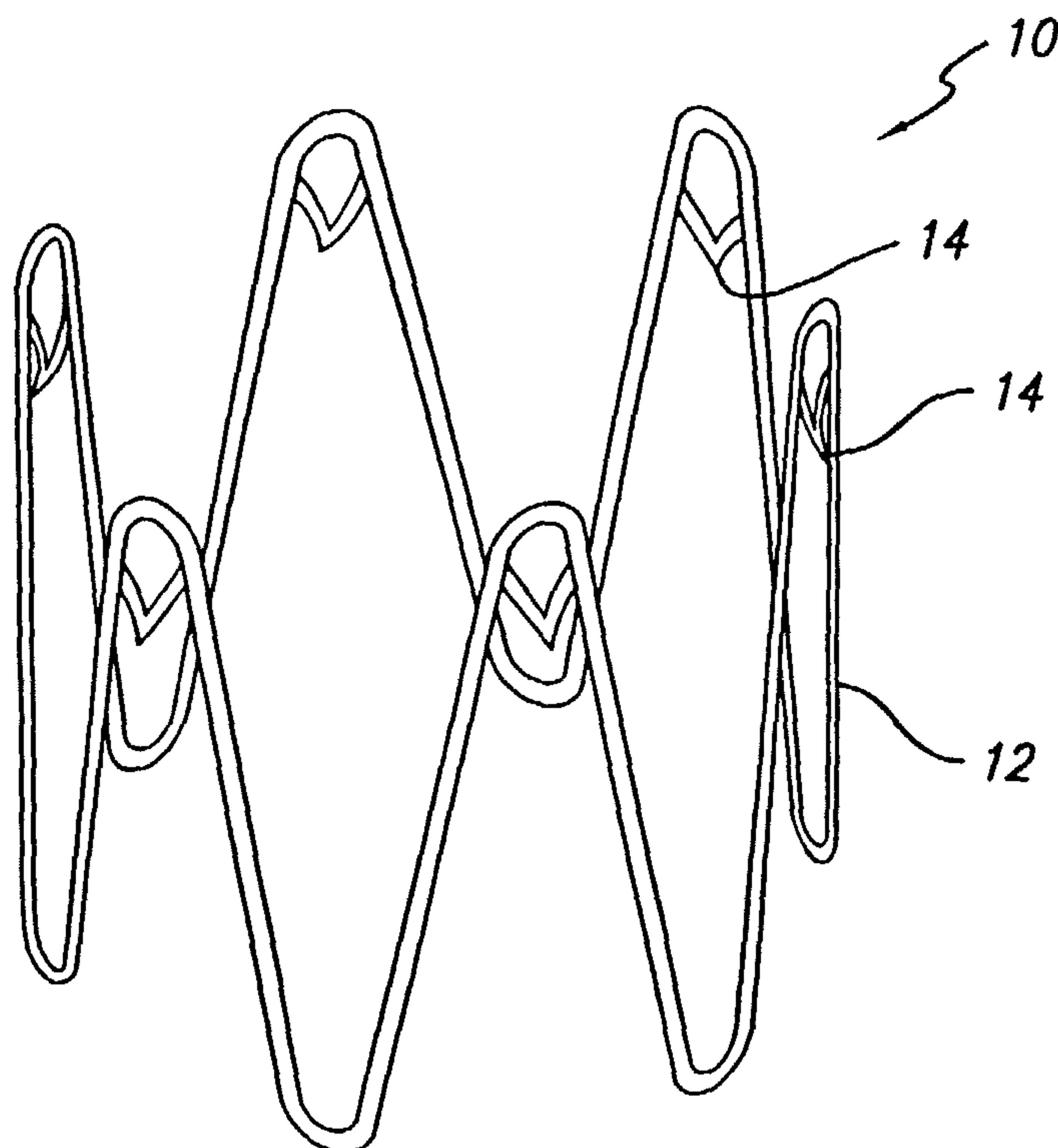

(86) Date de dépôt PCT/PCT Filing Date: 2003/02/20
 (87) Date publication PCT/PCT Publication Date: 2003/08/28
 (85) Entrée phase nationale/National Entry: 2004/07/28
 (86) N° demande PCT/PCT Application No.: US 2003/005385
 (87) N° publication PCT/PCT Publication No.: 2003/070126
 (30) Priorité/Priority: 2002/02/20 (10/079,155) US

(51) Cl.Int.⁷/Int.Cl.⁷ A61F 2/06
 (71) Demandeur/Applicant:
BARD PERIPHERAL VASCULAR, INC., US
 (72) Inventeurs/Inventors:
RANDALL, SCOTT, US;
BRATT, WILLIAM, US
 (74) Agent: SMART & BIGGAR

(54) Titre : DISPOSITIF D'ANCRAGE DESTINE A UNE PROTHESE ENDOLUMINALE
 (54) Title: ANCHORING DEVICE FOR AN ENDOLUMINAL PROSTHESIS



(57) **Abrégé/Abstract:**

An anchoring device for incorporation into an endoluminal prosthesis to prevent migration thereof in a reliable way without the problems associated with intraluminal delivery of the prosthesis. The anchoring device allows smooth, efficient delivery of the prosthesis by providing an anchoring system that does not engage the delivery catheter or sheath upon deployment of the prosthesis within a body lumen.

(12) INTERNATIONAL APPLICATION PUBLISHED UNDER THE PATENT COOPERATION TREATY (PCT)

(19) World Intellectual Property Organization
International Bureau(43) International Publication Date
28 August 2003 (28.08.2003)

PCT

(10) International Publication Number
WO 03/070126 A1

- (51) International Patent Classification⁷: A61F 2/06
- (21) International Application Number: PCT/US03/05385
- (22) International Filing Date: 20 February 2003 (20.02.2003)
- (25) Filing Language: English
- (26) Publication Language: English
- (30) Priority Data:
10/079,155 20 February 2002 (20.02.2002) US
- (63) Related by continuation (CON) or continuation-in-part (CIP) to earlier application:
US 10/079,155 (CIP)
Filed on 20 February 2002 (20.02.2002)
- (71) Applicant (for all designated States except US): IMPRA, INC., A SUBSIDIARY OF C.R. BARD, INC. [US/US]; 1415 West 3rd Street, Suite 109, P.O. Box 1740, Tempe, AZ 85280 (US).
- (72) Inventors; and
- (75) Inventors/Applicants (for US only): RANDALL, Scott [US/US]; 1803 W. Nido Avenue, Mesa, AZ 85202 (US).
- BRATT, William [US/US]; 7138 South Poplar Street, Tempe, AZ 85283 (US).
- (74) Agent: WIGHT, Todd, W.; Morrison & Foerster LLP, 555 W. Fifth Street, Suite 3500, Los Angeles, CA 90013 (US).
- (81) Designated States (national): AE, AG, AL, AM, AT, AU, AZ, BA, BB, BG, BR, BY, BZ, CA, CH, CN, CO, CR, CU, CZ, DE, DK, DM, DZ, EC, EE, ES, FI, GB, GD, GE, GH, GM, HR, HU, ID, IL, IN, IS, JP, KE, KG, KP, KR, KZ, LC, LK, LR, LS, LT, LU, LV, MA, MD, MG, MK, MN, MW, MX, MZ, NO, NZ, OM, PH, PL, PT, RO, RU, SC, SD, SE, SG, SK, SL, TJ, TM, TN, TR, TT, TZ, UA, UG, US, UZ, VC, VN, YU, ZA, ZM, ZW.
- (84) Designated States (regional): ARIPO patent (GH, GM, KE, LS, MW, MZ, SD, SL, SZ, TZ, UG, ZM, ZW), Eurasian patent (AM, AZ, BY, KG, KZ, MD, RU, TJ, TM), European patent (AT, BE, BG, CH, CY, CZ, DE, DK, EE, ES, FI, FR, GB, GR, HU, IE, IT, LU, MC, NL, PT, SE, SI, SK, TR), OAPI patent (BF, BJ, CF, CG, CI, CM, GA, GN, GQ, GW, ML, MR, NE, SN, TD, TG).
- Published:
— with international search report

[Continued on next page]

(54) Title: ANCHORING DEVICE FOR AN ENDOLUMINAL PROSTHESIS

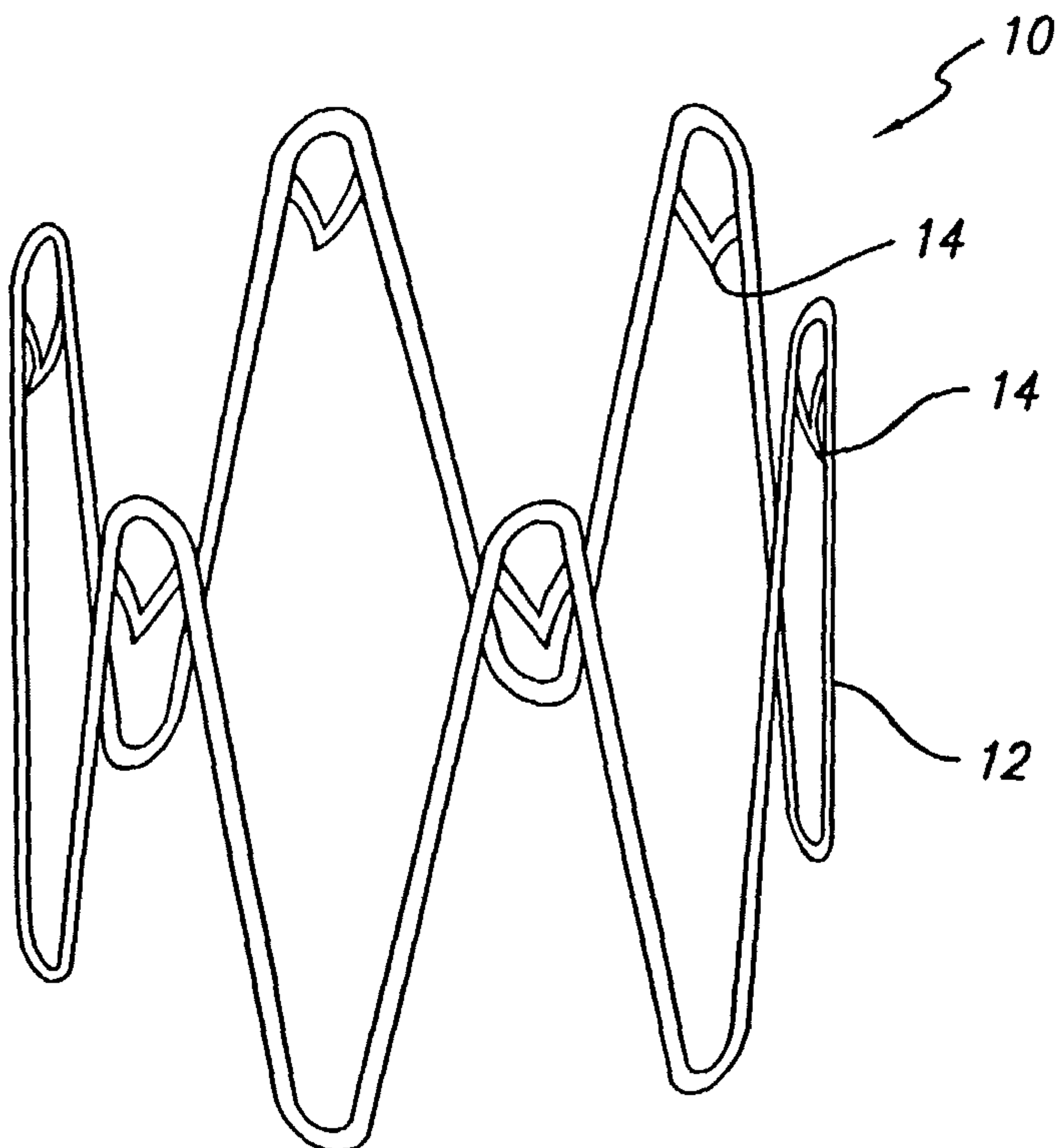

(57) Abstract: An anchoring device for incorporation into an endoluminal prosthesis to prevent migration thereof in a reliable way without the problems associated with intraluminal delivery of the prosthesis. The anchoring device allows smooth, efficient delivery of the prosthesis by providing an anchoring system that does not engage the delivery catheter or sheath upon deployment of the prosthesis within a body lumen.

WO 03/070126 A1

WO 03/070126 A1



— *before the expiration of the time limit for amending the claims and to be republished in the event of receipt of amendments*

For two-letter codes and other abbreviations, refer to the "Guidance Notes on Codes and Abbreviations" appearing at the beginning of each regular issue of the PCT Gazette.

ANCHORING DEVICE FOR AN ENDOLUMINAL PROSTHESIS

FIELD OF THE INVENTION

[0001] This invention relates generally to a device for preventing the migration of an endoluminal prosthesis and more particularly to a device that is
5 incorporated into and protrudes outward from an endoluminal prosthesis upon deployment thereof within a body lumen.

BACKGROUND OF THE INVENTION

[0002] Endoluminal prostheses such as stents, stent-grafts and other related devices are used to treat vessels that have become weakened or diseased. These
10 prostheses are used in a variety of circumstances to provide a remedy for the damaged vessels. The remedy can come in the form, for example, of added support for a vessel that has become weakened as a result of an aneurysm. In particular, in the case of an abdominal aortic aneurysm (AAA), in which a portion of a patient's aorta, the major artery carrying blood from the heart, has developed a weakened wall, a
15 graft is inserted to span the weakened region to facilitate a blood flow path between the healthy portions of the aorta.

[0003] In order to reduce the risk involved with invasive abdominal surgery, in which the patient's abdominal cavity is opened so that the graft can be sutured in place, many methods of percutaneous placement have been developed.
20 Accompanying percutaneous placement, however, is a need to maintain the graft in its inserted position in the absence of sutures. To this end, various anchoring devices have been proposed, most of which are attached to, or incorporated in, the graft. Examples of prior art anchoring devices include those found in U.S. Patent No.

5,843,167, in the form of an assembly that is attached to the graft. The assembly includes anchors which are attached to a graft on either end and which are connected by wire struts that extend along the length of the graft. These anchors have hooks that are formed on the end of short segments of wire that are secured to the anchor. The
5 hooks are adapted to protrude radially outwardly upon deployment of the endoprosthesis, extending a short distance beyond the bends of the anchor.

[0004] U.S. Patent No. 5,843,164 also discloses an anchoring system that includes hooks to penetrate the aortic wall. The hooks are generally provided at each end of the stent graft, each hook having one or more barb thereon. U.S. Patent No.
10 5,591,197 discloses a different type of anchor in the form of deformable connecting members that attach cylindrical elements which together form a stent. Upon balloon expansion of the connecting members, a notched, weakened area is forced outward to form a barb to penetrate the aortic wall. Finally, U.S. Patent No. 5, 593,434 discloses a plurality of projections or teeth cut away from a sheet of material, which is curled
15 into a cylinder to form a stent.

[0005] The drawback to these and other anchoring systems is that the teeth or hooks attached or integrated into the grafts or stents have a tendency to catch on the delivery sheaths or catheters during deployment. This creates problematic situations in the deployment process as the teeth or hooks tear the sheath material, preventing
20 the necessary precision required in percutaneous delivery into a body lumen.

[0006] Thus, it would be desirable to provide an anchoring device for an endoluminal prosthesis, which will forcefully engage the vessel wall upon

deployment and be configured so that contact with the delivery sheath or catheter upon insertion of the prosthesis is avoided.

BRIEF SUMMARY OF THE INVENTION

[0007] The invention enables the anchoring of an endoluminal prosthesis to prevent migration thereof in a reliable way without the problems associated with intraluminal delivery of the prosthesis. In particular, the invention allows smooth, efficient delivery of the prosthesis by providing an anchoring system that does not engage the delivery catheter or sheath upon deployment of the prosthesis within a body lumen.

[0008] What is claimed is a device for preventing migration of an endoluminal prosthesis, wherein the prosthesis has a contracted diameter and an expanded diameter, comprising a v-shaped member affixed to the prosthesis, wherein a tip of the V-shaped member is positioned to point toward a central axis of the prosthesis when the prosthesis is in the contracted diameter and is adapted to point away from the central axis of the prosthesis when the prosthesis is in the expanded diameter.

BRIEF DESCRIPTION OF THE DRAWINGS

- [0009] Fig. 1 illustrates a perspective view of an end portion of a stent with the inventive anchoring system attached thereto in a deployed state.
- [0010] Fig. 2 illustrates Fig. 1 in a contracted state for intraluminal delivery.
- 5 [0011] Fig. 3 is an enlarged view of the stent anchoring system in Fig. 1.
- [0012] Fig. 4 is an enlarged view of an alternate embodiment of the anchoring system of the present invention.
- [0013] Fig. 5 is an enlarged view of another alternate embodiment of the anchoring system of the present invention.
- 10 [0014] Fig. 6 is a view of a AAA device incorporating the anchoring system of the present invention as implanted.

DETAILED DESCRIPTION OF THE INVENTION

[0015] The following detailed description illustrates the invention by way of example, not by way of limitation, the principles of the invention. This description will clearly enable one skilled in the art to make and use the invention, and describes
5 several embodiments, adaptations, variations, alternatives and uses of the invention, including what we presently believe is the best mode of carrying out the invention.

[0016] The invention will be described by way of illustration with reference to a particular application of the present invention, namely for use with a AAA prosthesis. One of skill in the art should appreciate, however, that the present
10 invention could equally be utilized in countless other endoluminal prostheses, such as bare stents.

[0017] Referring now to Fig. 1, a preferred embodiment of the anchoring system of the present invention is illustrated. A ring stent 10 is shown having a body portion 12 and anchors 14. As shown in Fig. 1, the ring stent 10 is illustrated in its
15 deployed or enlarged diameter state. In this enlarged state, the anchors 14 point away from the inner portion of the ring stent 10 for attachment within a blood vessel. Fig. 2 shows the ring stent 10 in a collapsed or contracted state for implantation within a delivery catheter or sheath (not shown). It should be noted that the anchors 14 in this contracted state point inward toward a central axis of the stent 10 to avoid tearing or
20 damaging the catheter or sheath as it is withdrawn.

[0018] In addition to the benefits provided by the anchoring system of the present invention with regard to maintaining the integrity of the delivery catheter or sheath and thereby preventing associated problems thus presented, such as difficulty

with placement of the device, the anchoring system is also optimal for preventing migration of the endoluminal prosthesis with which it is associated.

[0019] Referring again to Figs. 1 and 2, the delivery process will be described in more detail. The stent 10 is initially in a dormant position when in its contracted state during percutaneous insertion into a patient's vessel, as shown in Fig. 2. The stent 10 can be maintained in this dormant state in a number of ways, including, for example, physical constraint imposed by a delivery catheter or sheath and temperature induced restraint (when the stent is made of shape memory material). Upon reaching the predetermined site within the vessel for deployment of the stent 10 or prosthesis to which the stent 10 is incorporated, a delivery catheter will be withdrawn, generally by sliding off of the stent 10. Because of this sliding action of the catheter or sheath, which is usually made of a soft material, it is important that no sharp edges engage the sheath. As stated above, the stent 10 is advantageously designed with the sharp portion of the anchors 14 pointing inward toward a central axis of the stent 10 to address this concern. When the catheter or sheath is withdrawn and the constraint is removed, the stent 10 expands to an expanded diameter shown in Fig. 1. As the stent 10 expands, the anchors 14 "spring" outward to secure the stent 10 in place within the vessel.

[0020] The spring action of anchors 14 takes place due to its design, placement and make-up. In the preferred embodiment, the anchors 14 comprise a V-shaped member that is affixed to a stent. The V-shaped member can be attached to the stent separately or can be formed into the stent (*see* Fig. 5). Preferably, a plurality of V-shaped members are arranged around the circumference the stent as showed in Figs. 1 and 2. The V-shaped members can be incorporated into ring stents as shown

in Figs. 1 and 2, or other types of stents, in which the V-shaped members can be placed around one or both of the ends and/or in the middle region thereof. The V-shaped members are preferably made of stainless steel, although in a shape memory stent the V-shaped members would preferably be made from Nitinol. Of course, many other materials are available which would similarly provide a "springing" action outward upon expansion or deployment of the stent within the vessel.

[0021] The springing action, as discussed, can be attributed to the material and shape of the anchor as well as the placement thereof within the stent. As depicted in Fig. 2, the anchors 14 are pointed toward a central axis of the stent 10. This occurs because the anchors 14 are positioned within the stent 10 when the stent 10 is in a relaxed state, as shown in Fig. 3. Due to the configuration of the anchors 14 in combination with the stiffness of the material, the anchors 14 will point in a respective direction (either outwardly or inwardly) when a force is applied to the stent 10, because the bending force will be transmitted along the length of the anchors 14 without bending at the tip of the anchor itself. This occurrence can be manipulated by altering the design and material selection of the anchor 14 to achieve a greater or lesser spring action.

[0022] Figs. 4 and 5 show examples of alternate embodiments of the V-shaped members of the present invention. Fig. 4 illustrates a stent 20 with anchors 24, incorporated into stent body 22, the anchors 24 having a thicker body than that of anchor 14. Fig. 5 illustrates a stent 30 having anchors 34 that are integral with a stent body 32.

[0023] Fig. 6 shows a portion of the abdominal aortic artery of a patient connected in its upper part with thoracic artery 50 and branching into two iliac arteries 54 and 56. The abdominal aorta presents an aneurysm 52. The stent 10 is incorporated into a AAA prosthesis 40 for treatment of the artery and is shown in its
5 deployed condition so that anchors 14 are engaging the wall of the artery 50. In this embodiment, stents 16 and 18 hold the left and right legs of the prosthesis 40 in place within the iliac arteries 54 and 56. As shown, stents 16 and 18 do not have anchors incorporated therein although it is certainly possible in an alternate embodiment for all stents of the prosthesis 40 to have anchors. The anchors 14 incorporated in stent
10 10 hold the AAA prosthesis 40 in position within the artery and prevent migration thereof.

[0024] The present invention has been described above in terms of a presently preferred embodiment so that an understanding of the present invention can be conveyed. There are, however, many configurations for an anchoring system for
15 endoluminal prostheses not specifically described herein but with which the present invention is applicable. The present invention should therefore not be seen as limited to the particular embodiments described herein, but rather, it should be understood that the present invention has wide applicability with respect to endoluminal prostheses generally. All modifications, variations, or equivalent arrangements and
20 implementations that are within the scope of the attached claims should therefore be considered within the scope of the invention.

CLAIMS

We Claim:

1. A device for preventing migration of an endoluminal prosthesis, wherein the prosthesis has a contracted diameter and an expanded
5 diameter, comprising a V-shaped member affixed to the prosthesis, wherein a tip of the v-shaped member is positioned to point toward a central axis of the prosthesis when the prosthesis is in the contracted diameter and is adapted to point away from the central axis of the prosthesis when the prosthesis is in the expanded diameter.

2. The device according to claim 1, wherein the v-shaped member
10 is made from a material selected from the group consisting of alloys, Nitinol and stainless steel

3. A device for preventing migration of an endoluminal prosthesis, comprising an anchoring means for anchoring the prosthesis in a location within a body lumen, wherein the anchoring means is adapted to spring from a first
15 inward position to a second outward position upon deployment of the prosthesis.

1/3

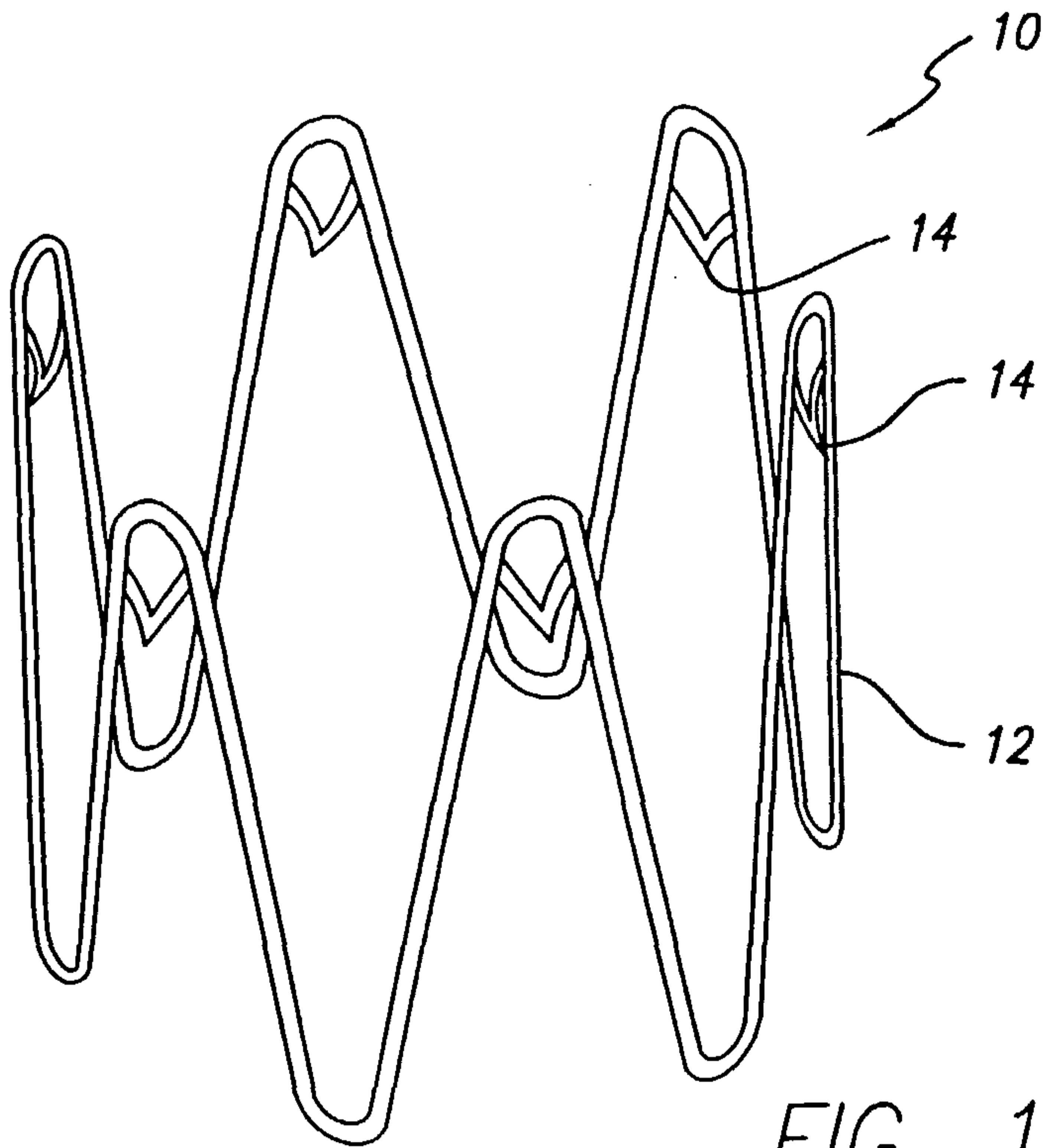

FIG. 1 X

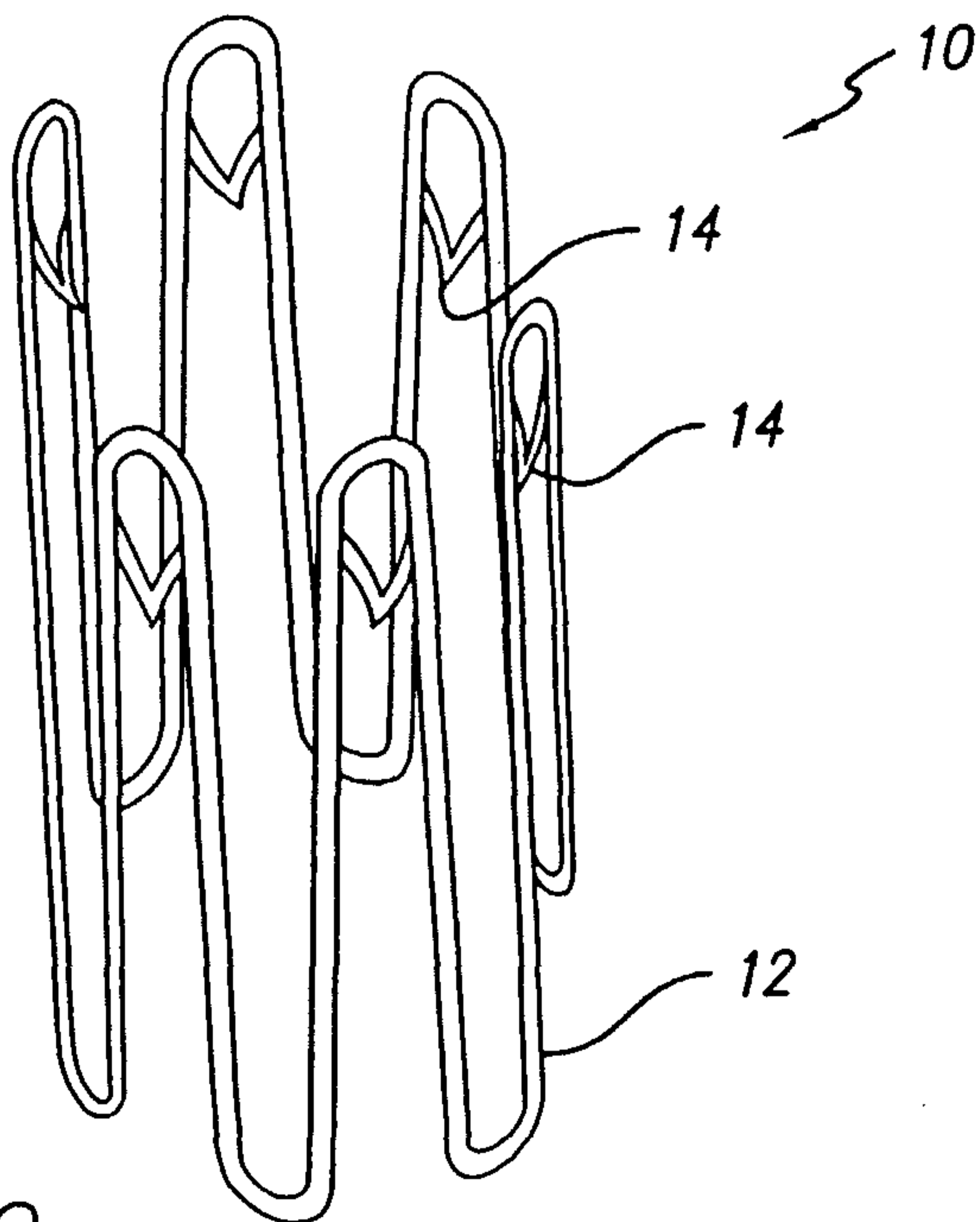
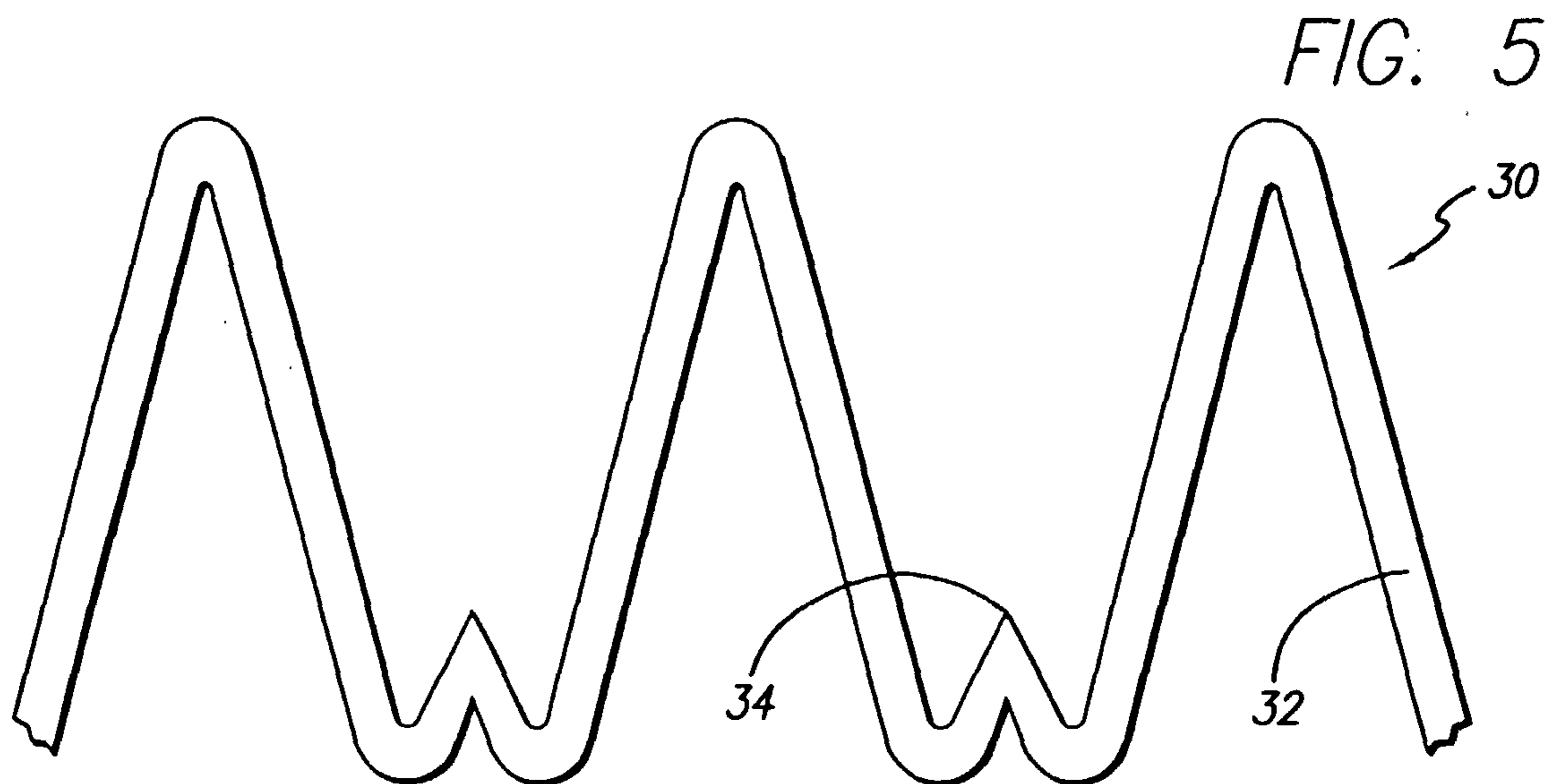
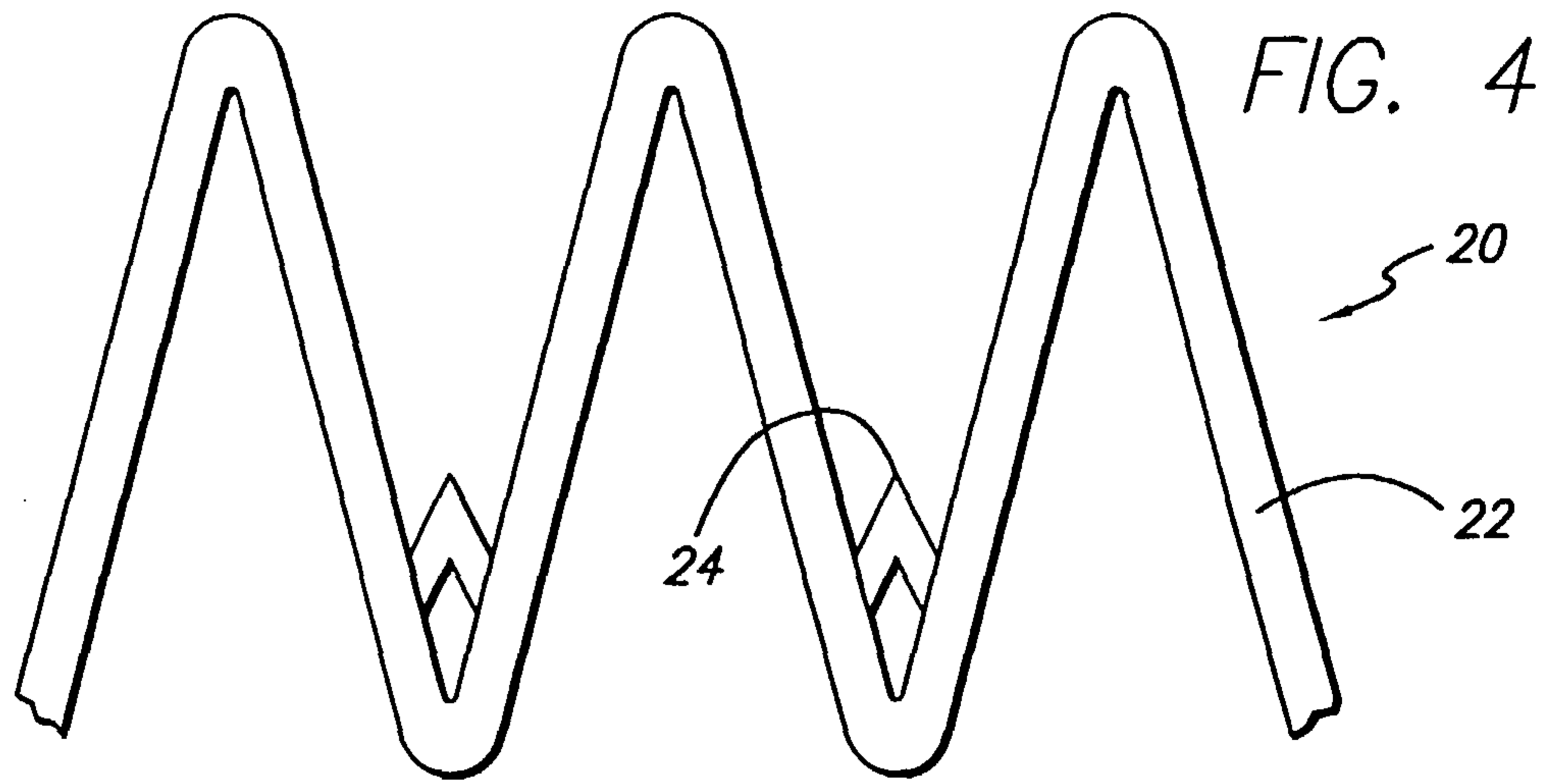
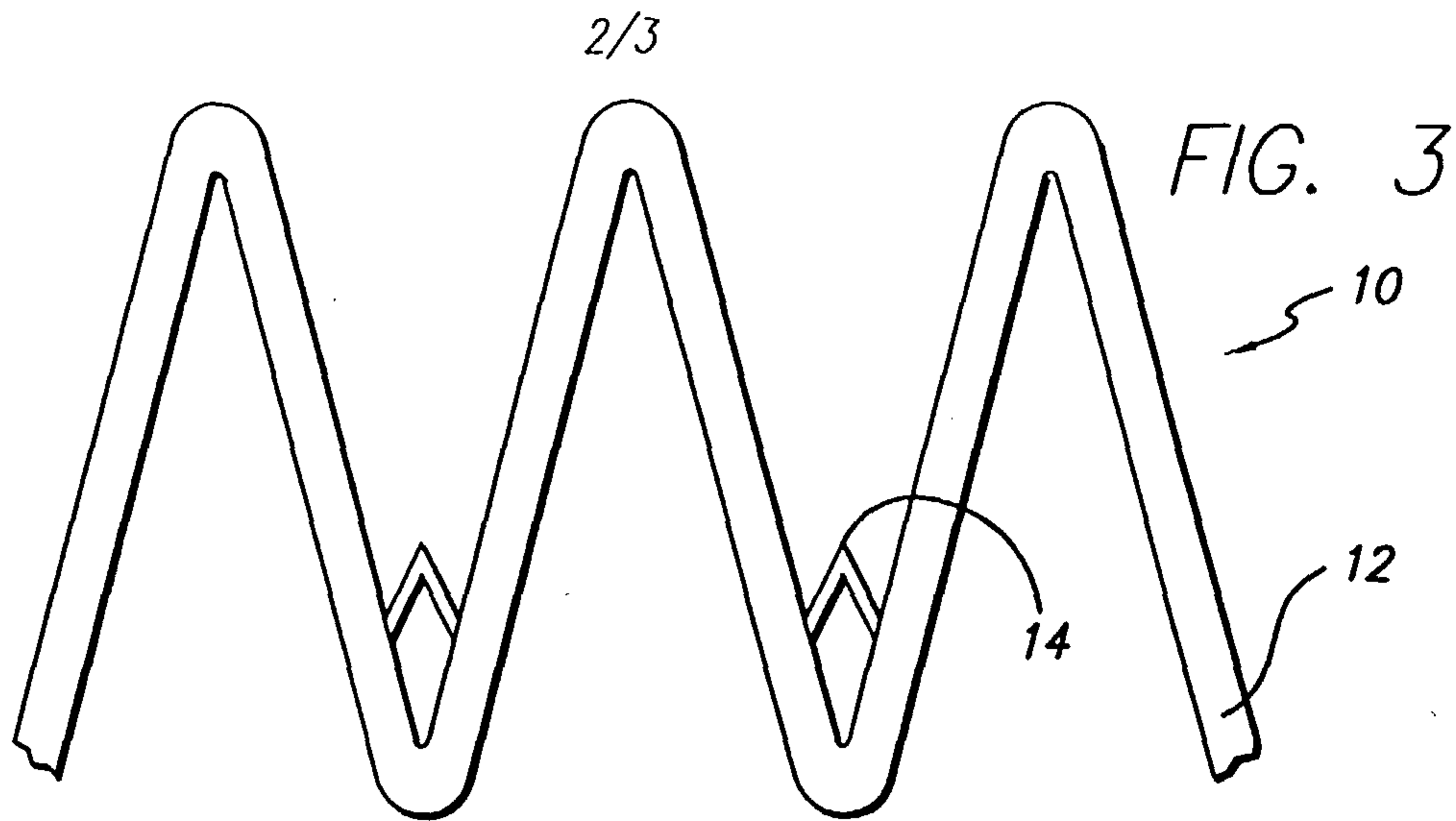

FIG. 2



3/3

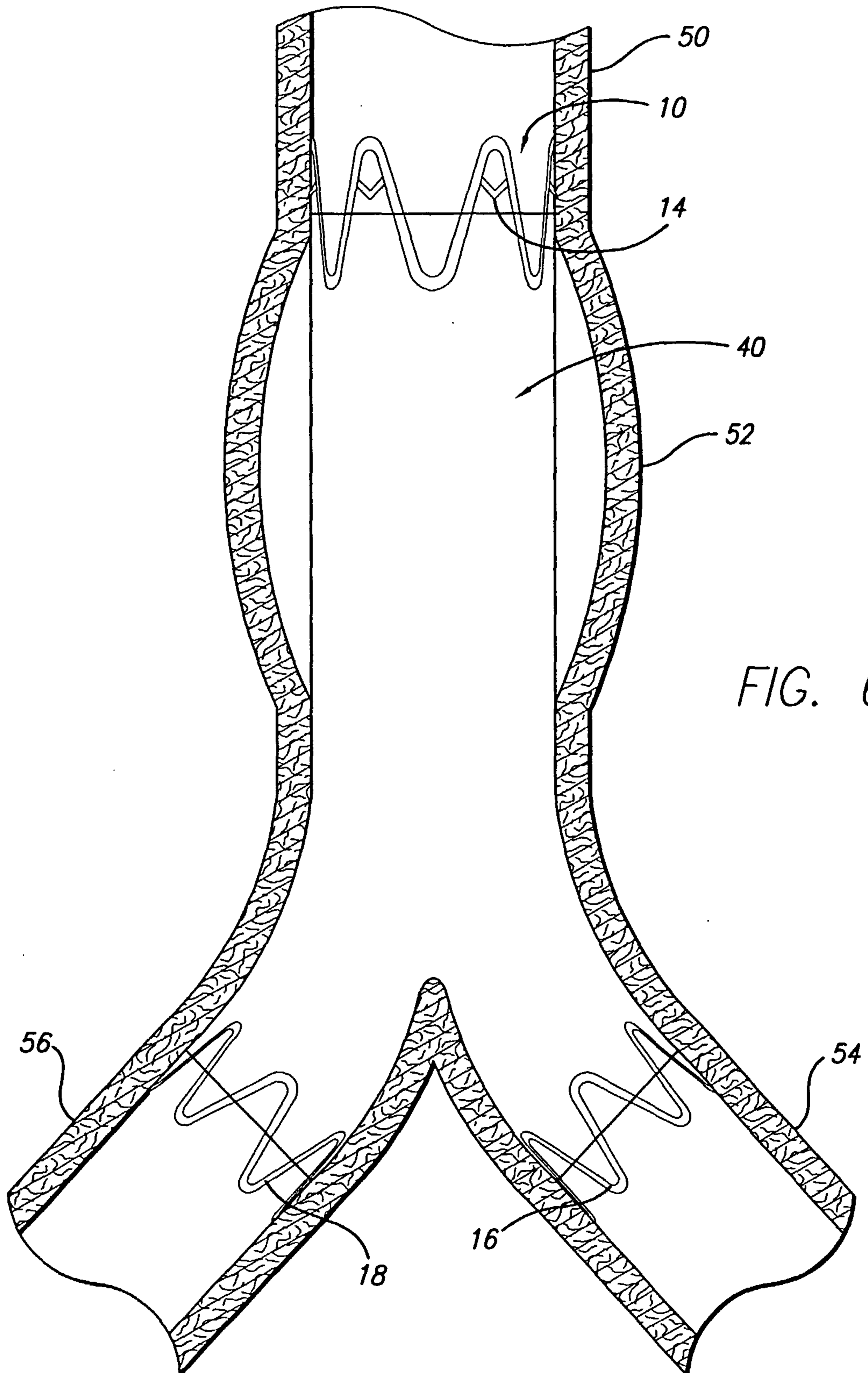

FIG. 6

