



US00D551631S

(12) **United States Design Patent**
Mayo et al.

(10) **Patent No.:** **US D551,631 S**

(45) **Date of Patent:** **** Sep. 25, 2007**

(54) **WALL-MOUNTABLE LIGHTING CONTROL UNIT**

(75) Inventors: **Noel Mayo**, Philadelphia, PA (US);
Elliot G. Jacoby, Glenside, PA (US);
Michael Hash, North Wales, PA (US);
Matthew Swatsky, Macungie, PA (US);
Joel S. Spira, Coopersburg, PA (US)

(73) Assignee: **Lutron Electronics Co., Inc.**,
Coopersburg, PA (US)

(**) Term: **14 Years**

(21) Appl. No.: **29/260,547**

(22) Filed: **May 26, 2006**

(51) **LOC (8) Cl.** **13-03**

(52) **U.S. Cl.** **D13/164**

(58) **Field of Classification Search** D13/162,
D13/164, 169, 170, 171, 177; D8/353; 200/5 A,
200/293, 296, 297, 329, 333, 335, 339, 341,
200/520, 530, 537, 552; 220/241; 307/125,
307/139; 315/291-296

See application file for complete search history.

(56) **References Cited**

U.S. PATENT DOCUMENTS

4,924,151 A * 5/1990 D'Aleo et al. 315/295

(Continued)

OTHER PUBLICATIONS

Leviton Manufacturing Co., "Dimensions Architectural Lighting Control Systems", Lighting Controls Product Selection Guide, 2004, front cover, pp. D1, D4, D5, back cover.

(Continued)

Primary Examiner—Selina Sikder

(74) *Attorney, Agent, or Firm*—Mark E. Rose

(57) **CLAIM**

We claim the ornamental design for a wall-mountable lighting control unit, as shown and described.

DESCRIPTION

FIG. 1 is a perspective view of a wall-mountable lighting control unit according to a first embodiment of our new design.

FIG. 2 is a front view thereof.

FIG. 3 is a left side view thereof.

FIG. 4 is a right side view thereof.

FIG. 5 is a top view thereof.

FIG. 6 is a bottom view thereof.

FIG. 7 is a perspective view of a wall-mountable lighting control unit according to a second embodiment of our new design.

FIG. 8 is a front view thereof, the left side, right side, top and bottom views, respectively, of the second embodiment being identical to the left side, right side, top and bottom views of the first embodiment.

FIG. 9 is a perspective view of a wall-mountable lighting control unit according to a third embodiment of our new design.

FIG. 10 is a front view thereof, the left side, right side, top and bottom views, respectively, of the third embodiment being identical to the left side, right side, top and bottom views of the first embodiment.

FIG. 11 is a perspective view of a wall-mountable lighting control unit according to a fourth embodiment of our new design; and,

FIG. 12 is a front view thereof, the left side, right side, top and bottom views, respectively, of the fourth embodiment being identical to the left side, right side, top and bottom views of the first embodiment.

The rear views form no part of the design and are omitted. The portions of the drawings appearing in broken line are for environment only and do not form a part of the design.

1 Claim, 10 Drawing Sheets

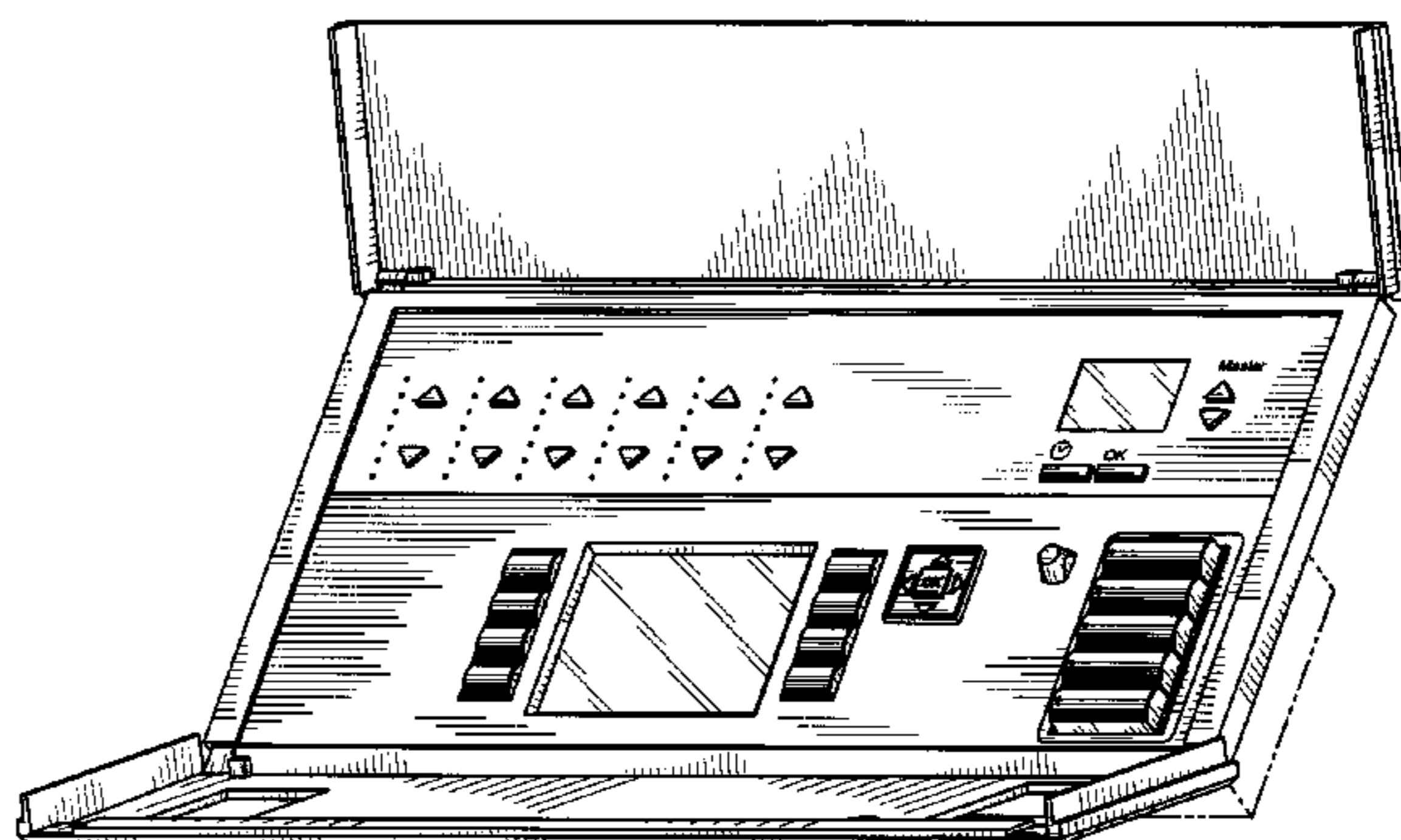
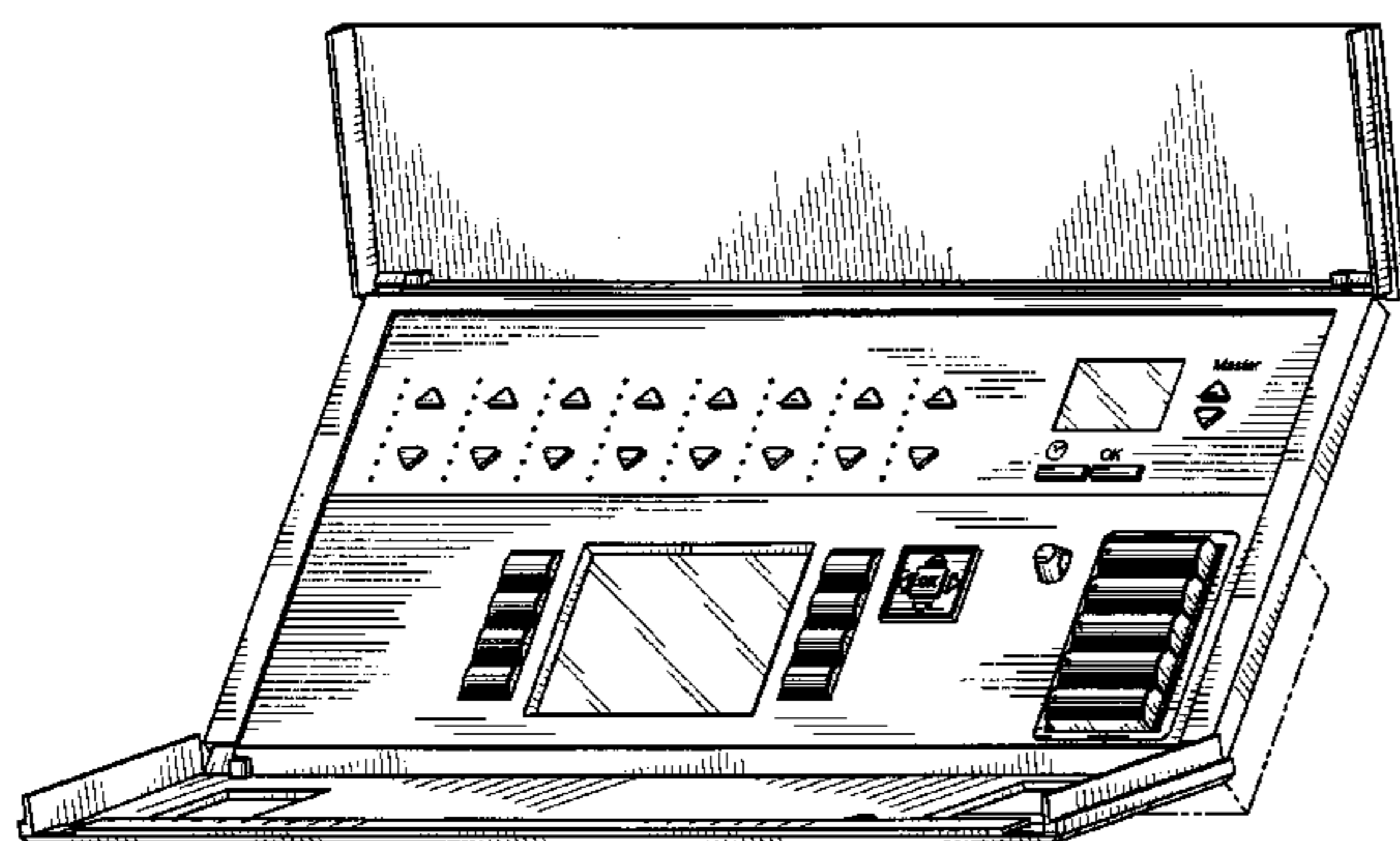

US D551,631 S

Page 2

U.S. PATENT DOCUMENTS

D311,170 S 10/1990 Mayo et al.
D313,738 S 1/1991 Mayo et al.
5,030,893 A * 7/1991 Spira et al. 315/294
D319,429 S 8/1991 D'Aleo et al.
5,191,265 A * 3/1993 D'Aleo et al. 315/295
D344,264 S 2/1994 D'Aleo et al.
5,949,200 A * 9/1999 Ference et al. 315/318
D465,460 S 11/2002 Mayo et al.
D509,804 S 9/2005 Butler et al.
D510,072 S 9/2005 Butler et al.
D515,512 S 2/2006 Butler et al.
D515,513 S 2/2006 Butler et al.
D515,514 S * 2/2006 Butler et al. D13/164
D516,042 S 2/2006 Butler et al.
D517,021 S * 3/2006 Butler et al. D13/164

D517,498 S 3/2006 Butler et al.
D529,871 S * 10/2006 Butler et al. D13/164

OTHER PUBLICATIONS

Leviton Manufacturing Co., D3200 Architectural Lighting Control System Brochure, date unknown, 12 pages.
Leviton Manufacturing Co., D3200 Architectural Lighting Control System Specification Guide, date unknown, 12 pages.
Creston Electronics, iLux Integrated Lighting System Specification Sheet, Oct. 2005, 2 pages.
Creston Electronics, iLux Lighting System User Guide, Dec. 2005, 8 pages.
Creston Electronics, iLux Lighting System Operations Guide, Jan. 2006, front cover, pp. 5-7, back cover.

* cited by examiner

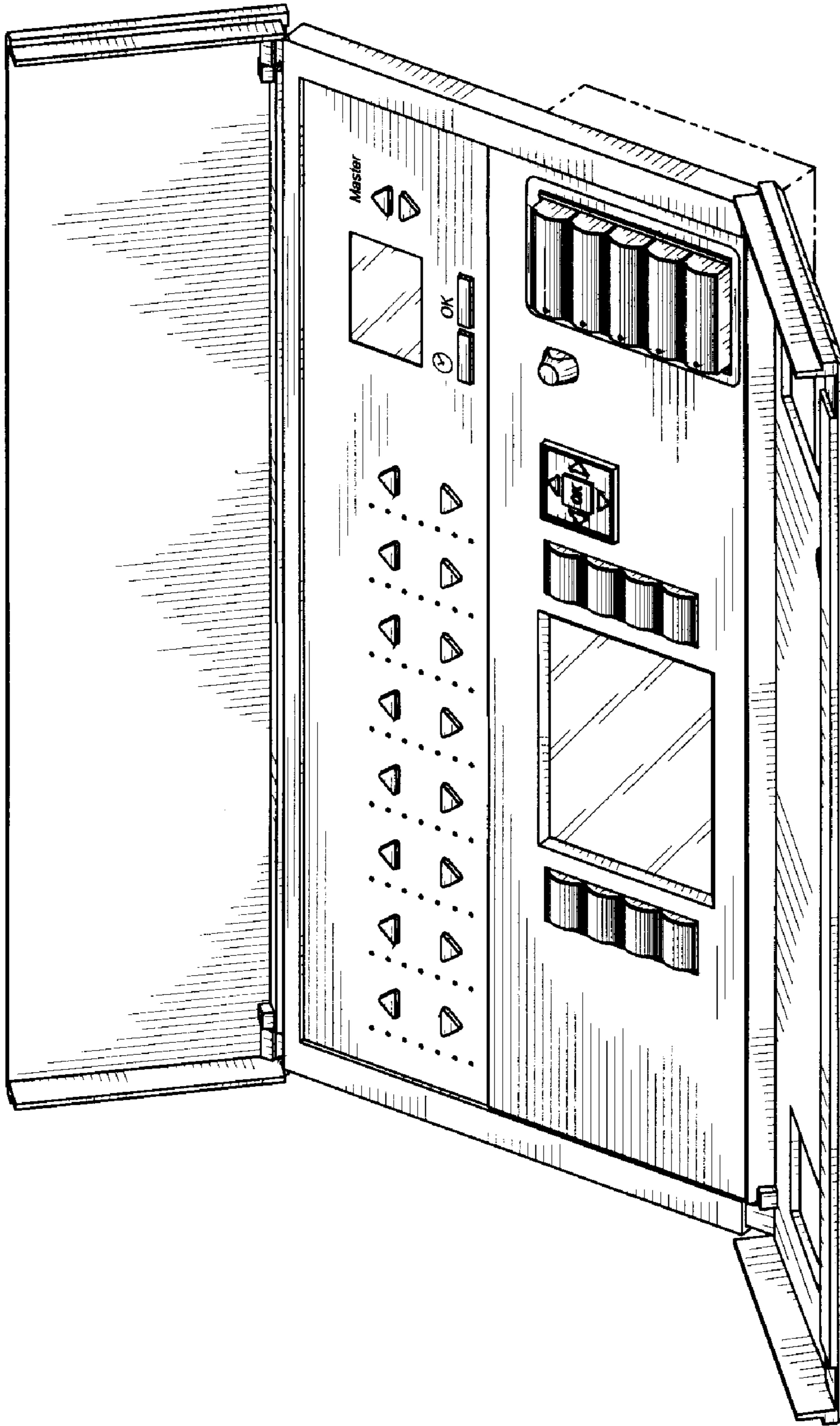

Fig. 1

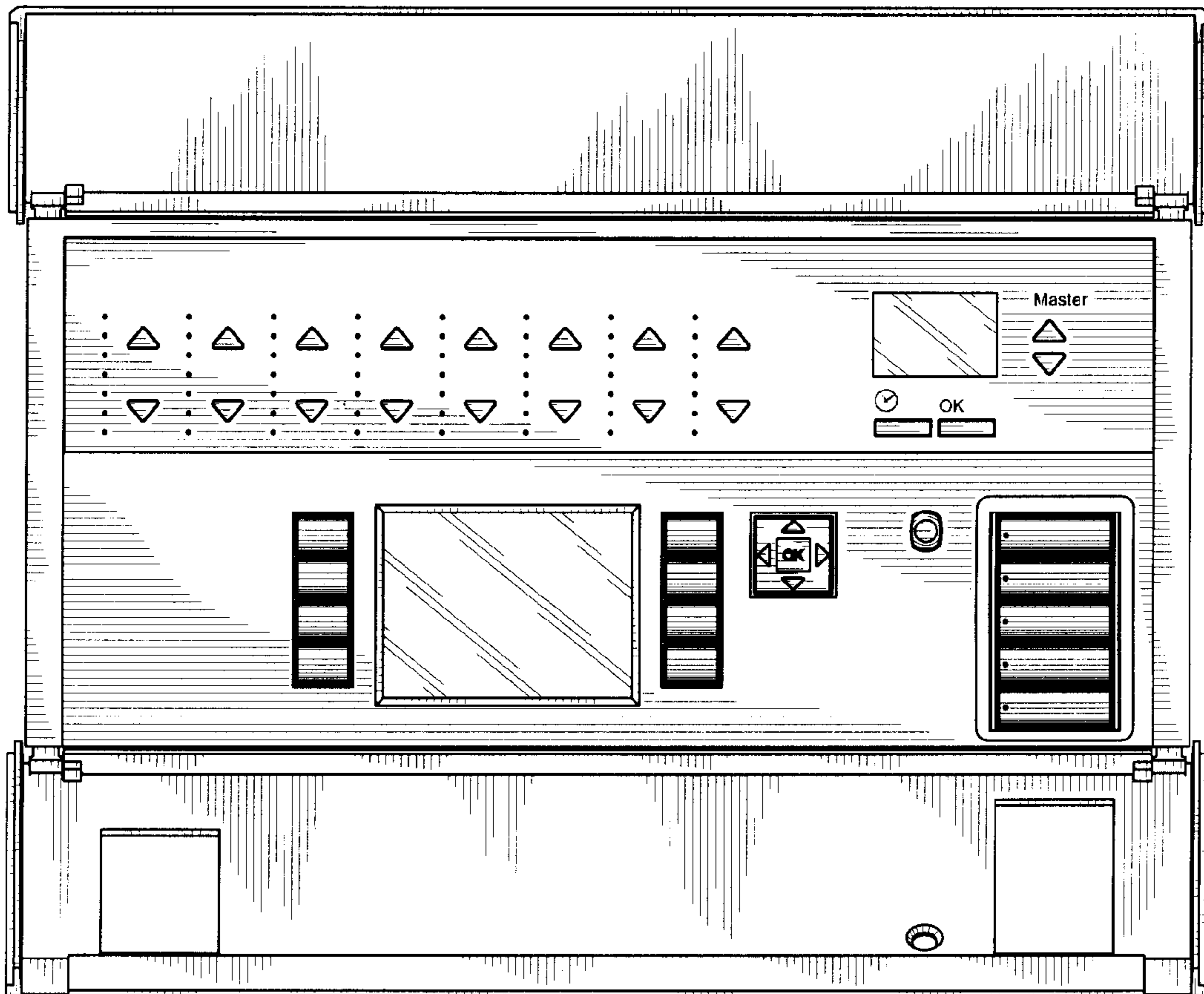

Fig. 2

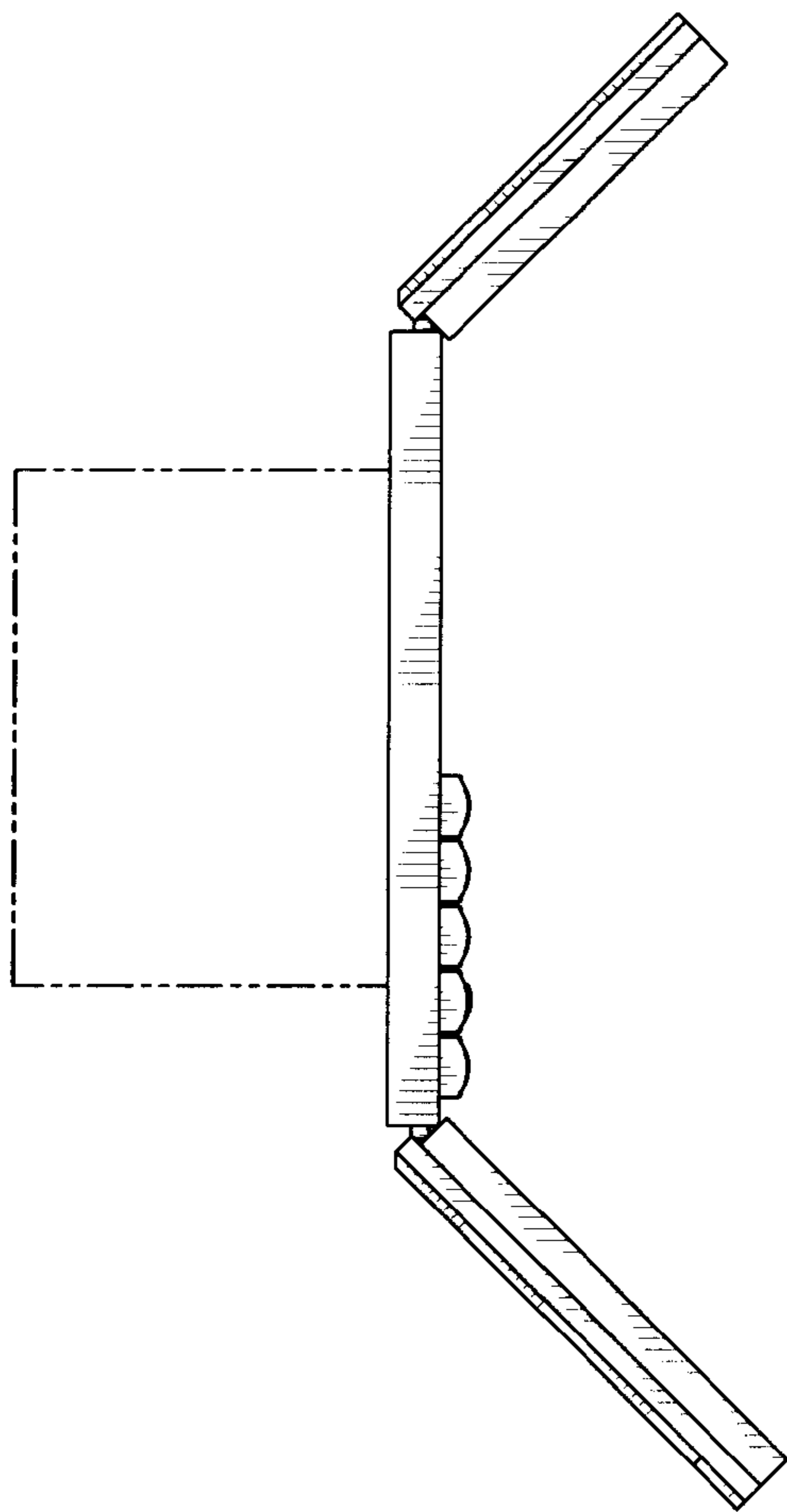

Fig. 3

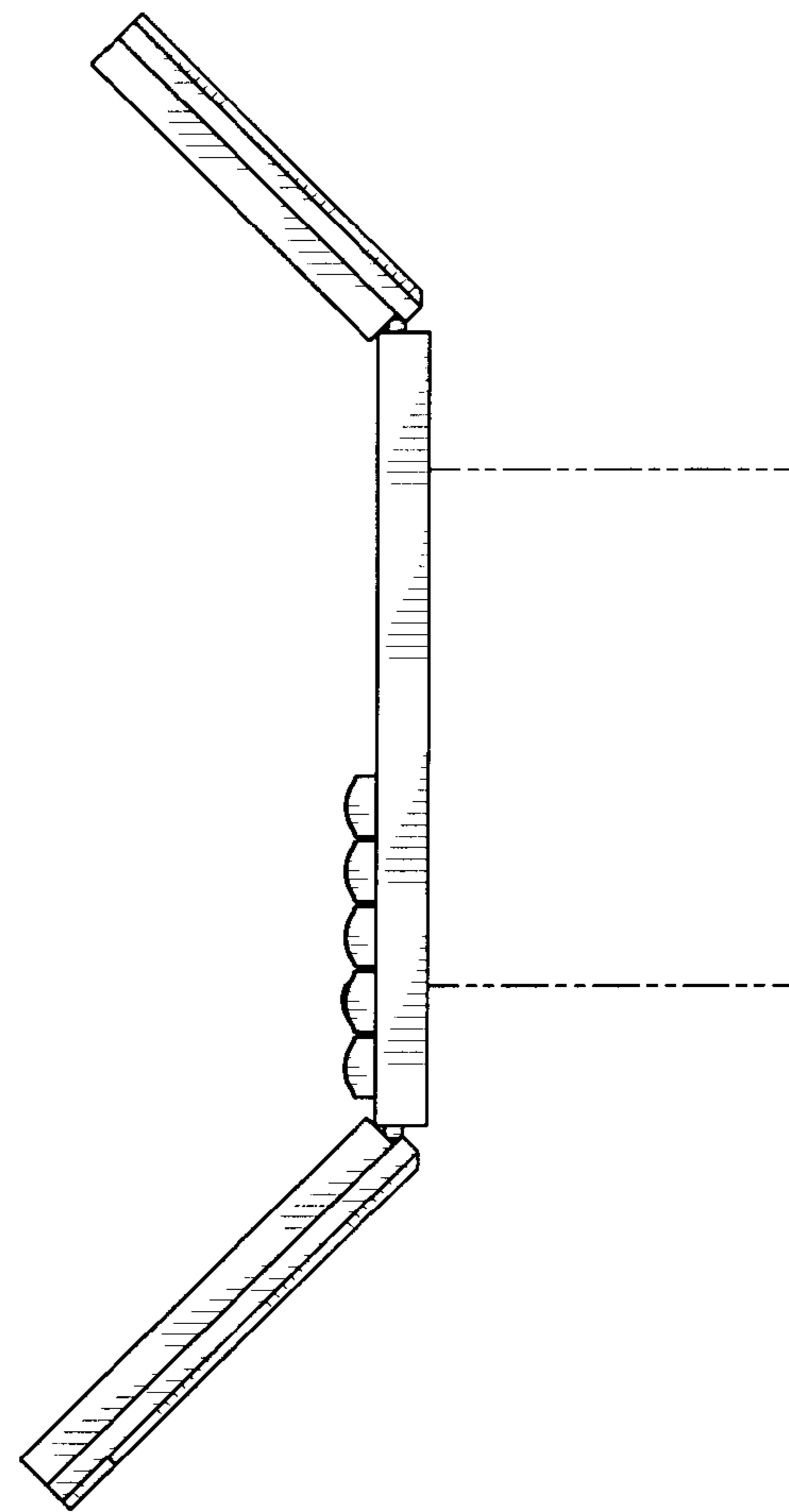

Fig. 4

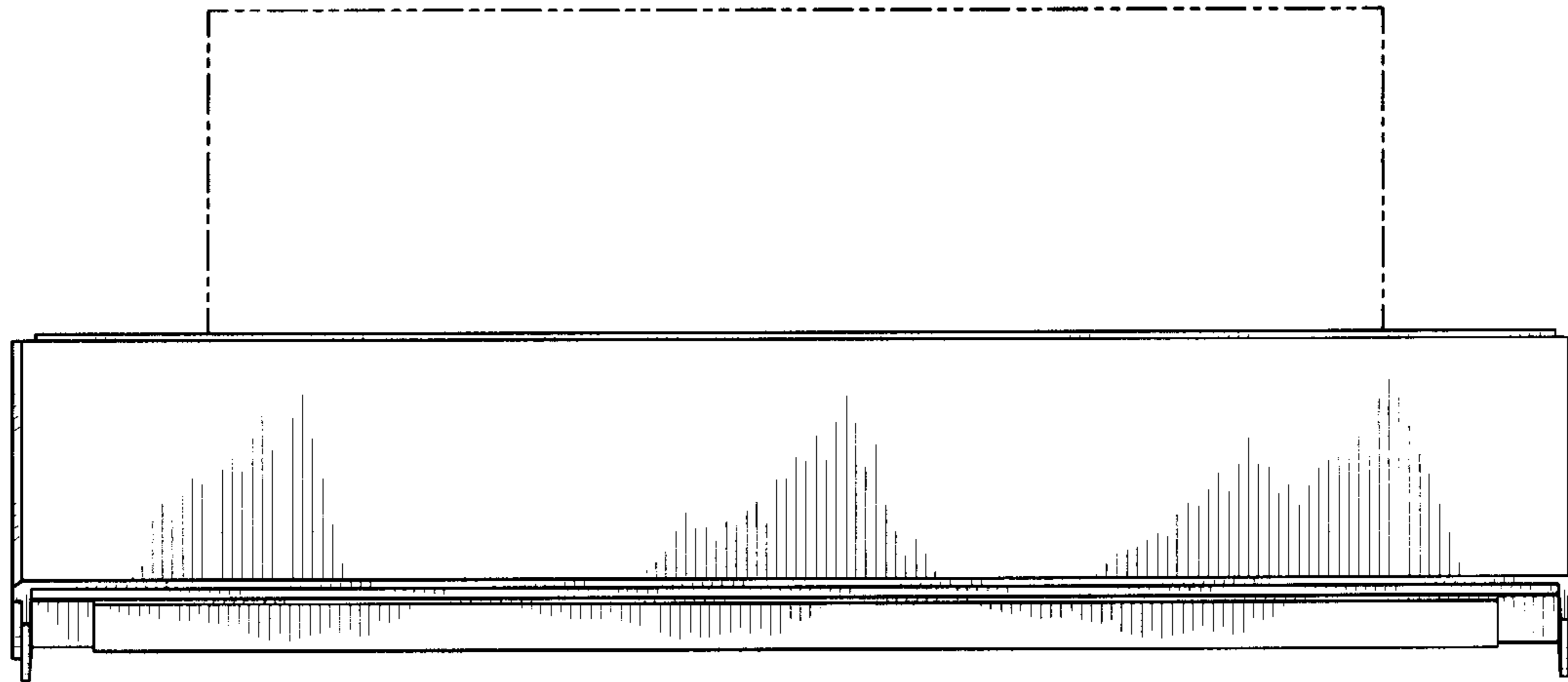

Fig. 5

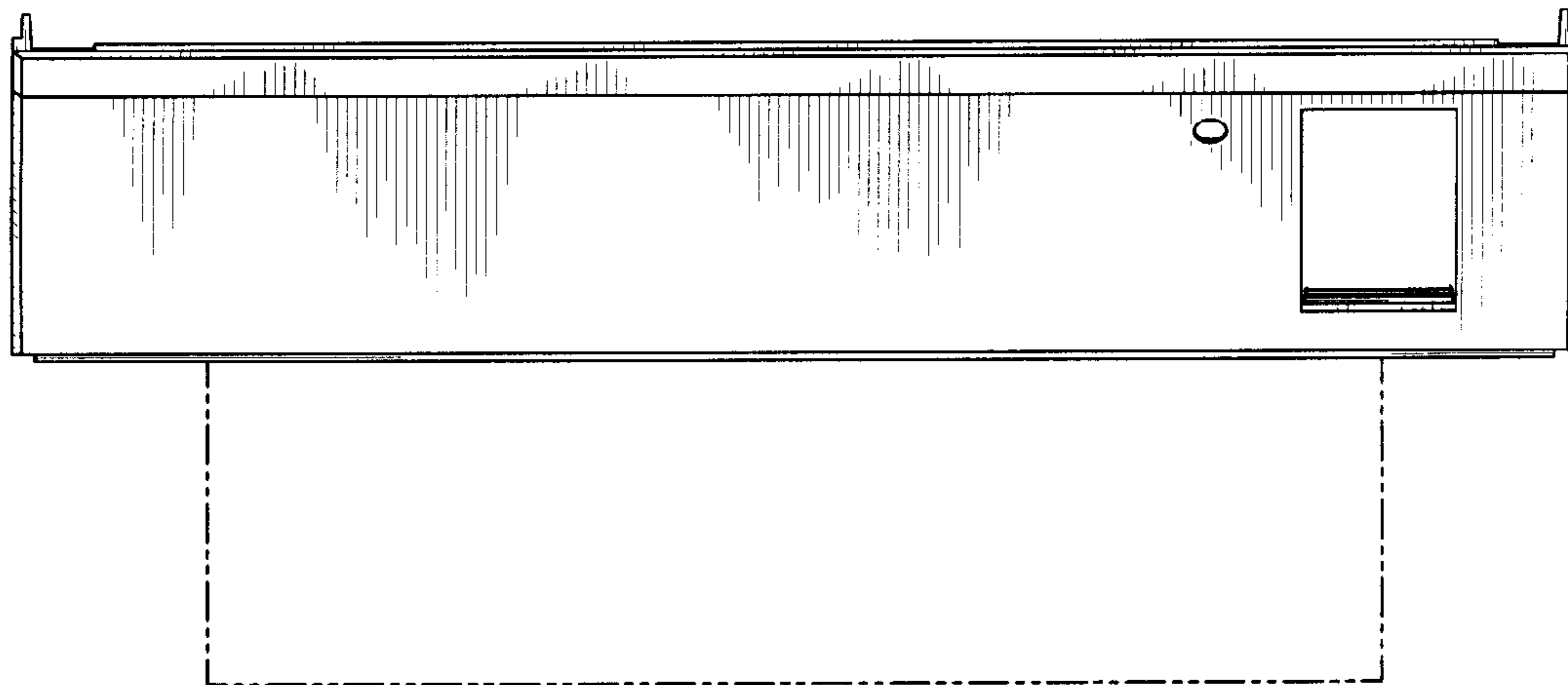

Fig. 6

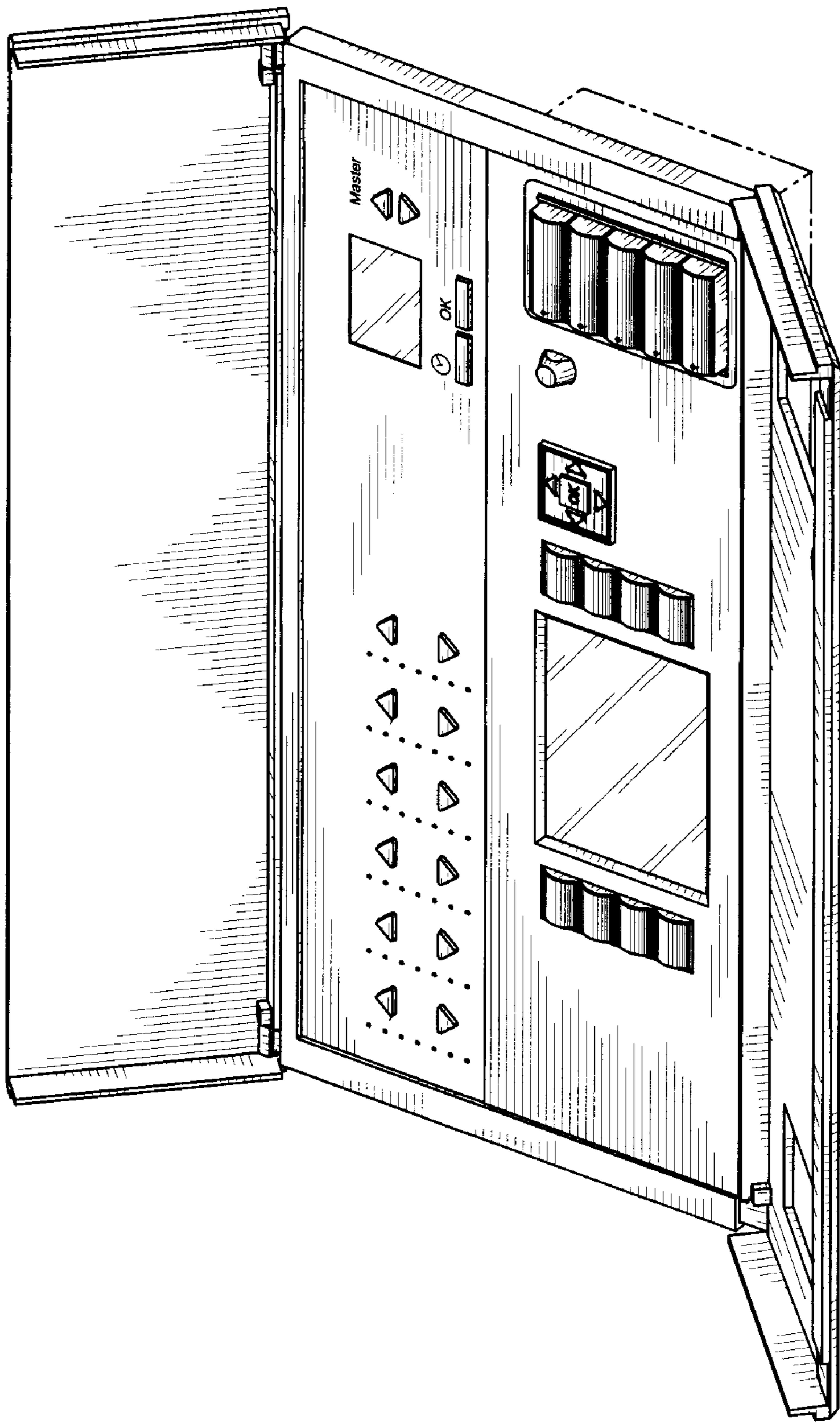

Fig. 7

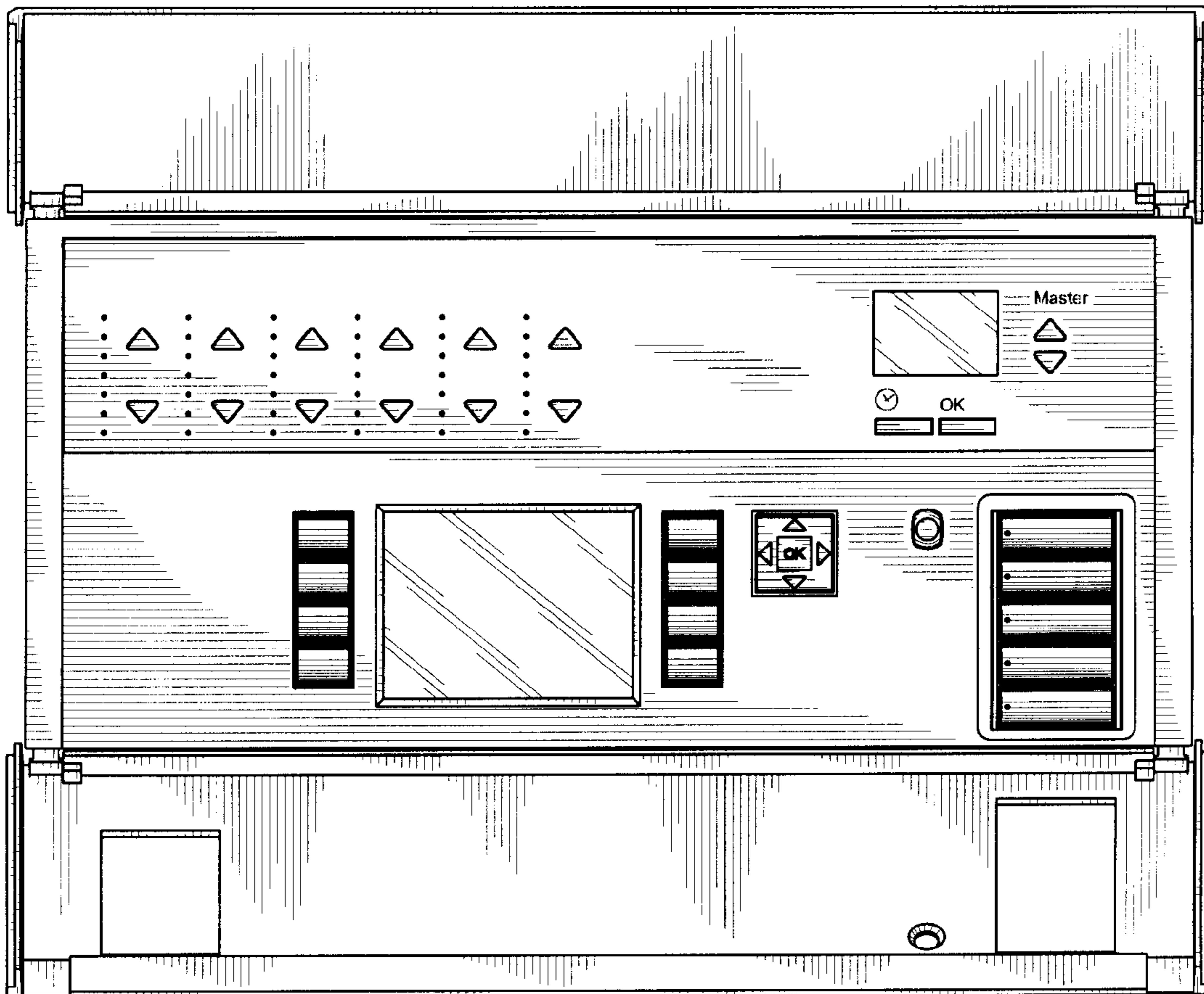

Fig. 8

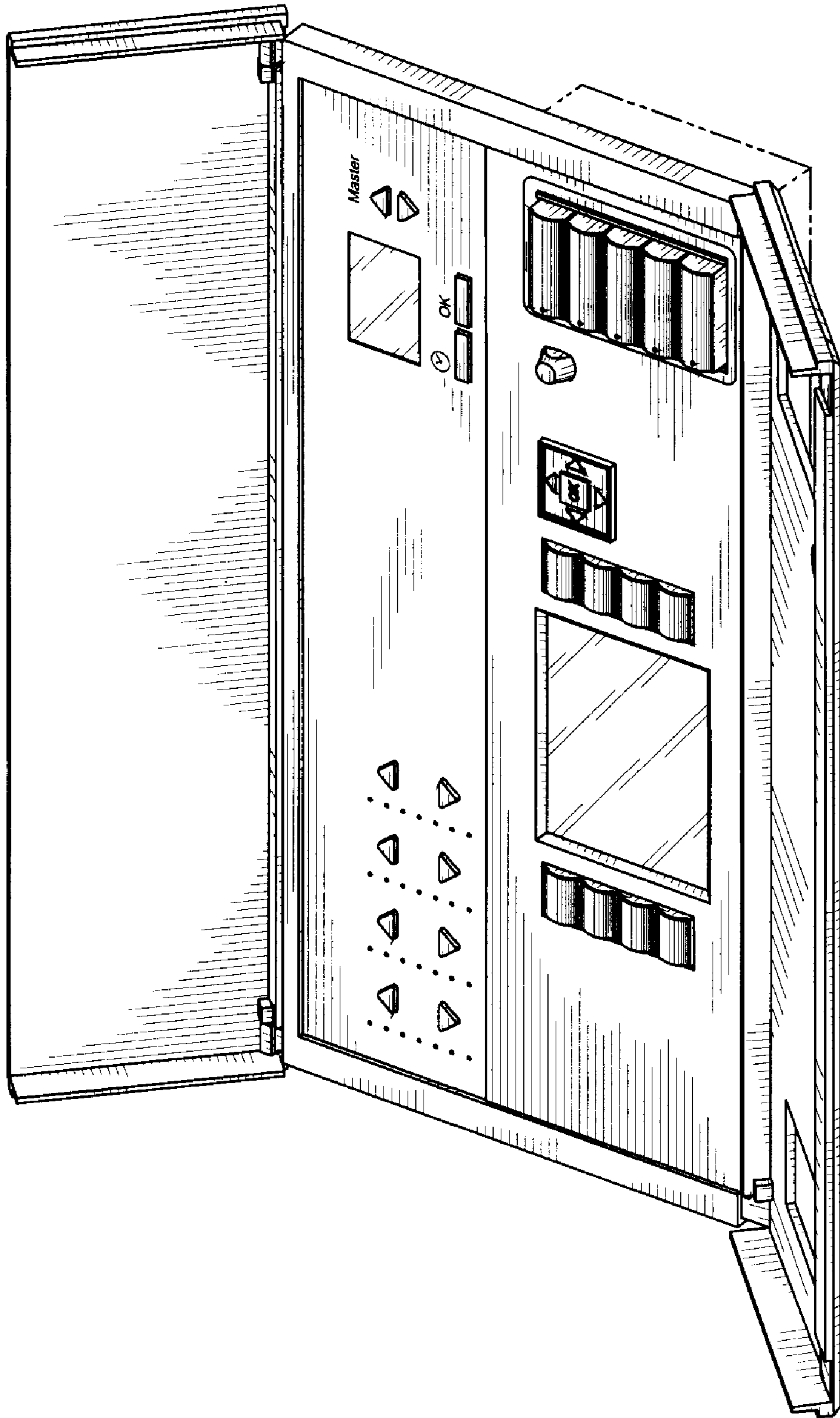

Fig. 9

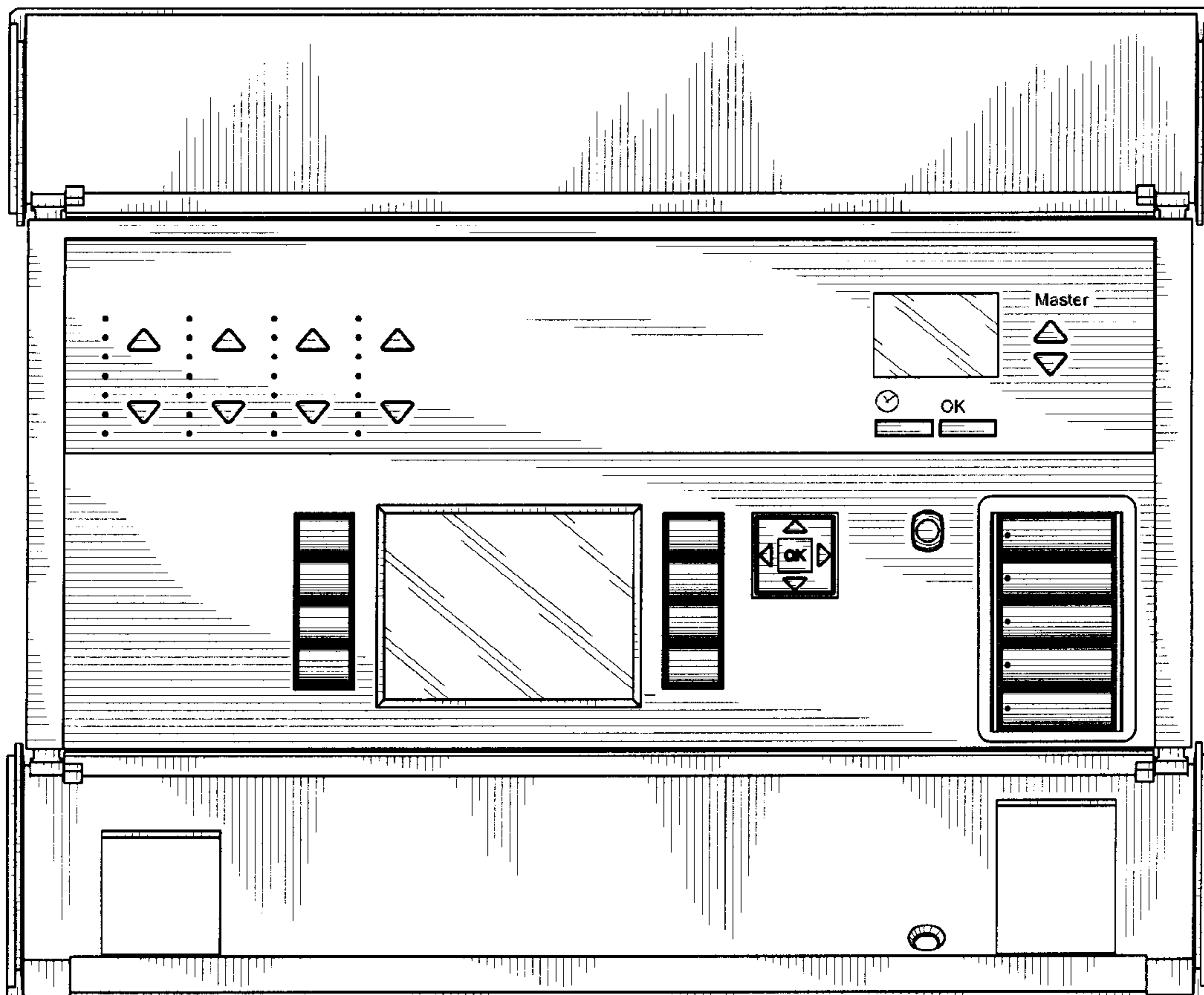

Fig. 10

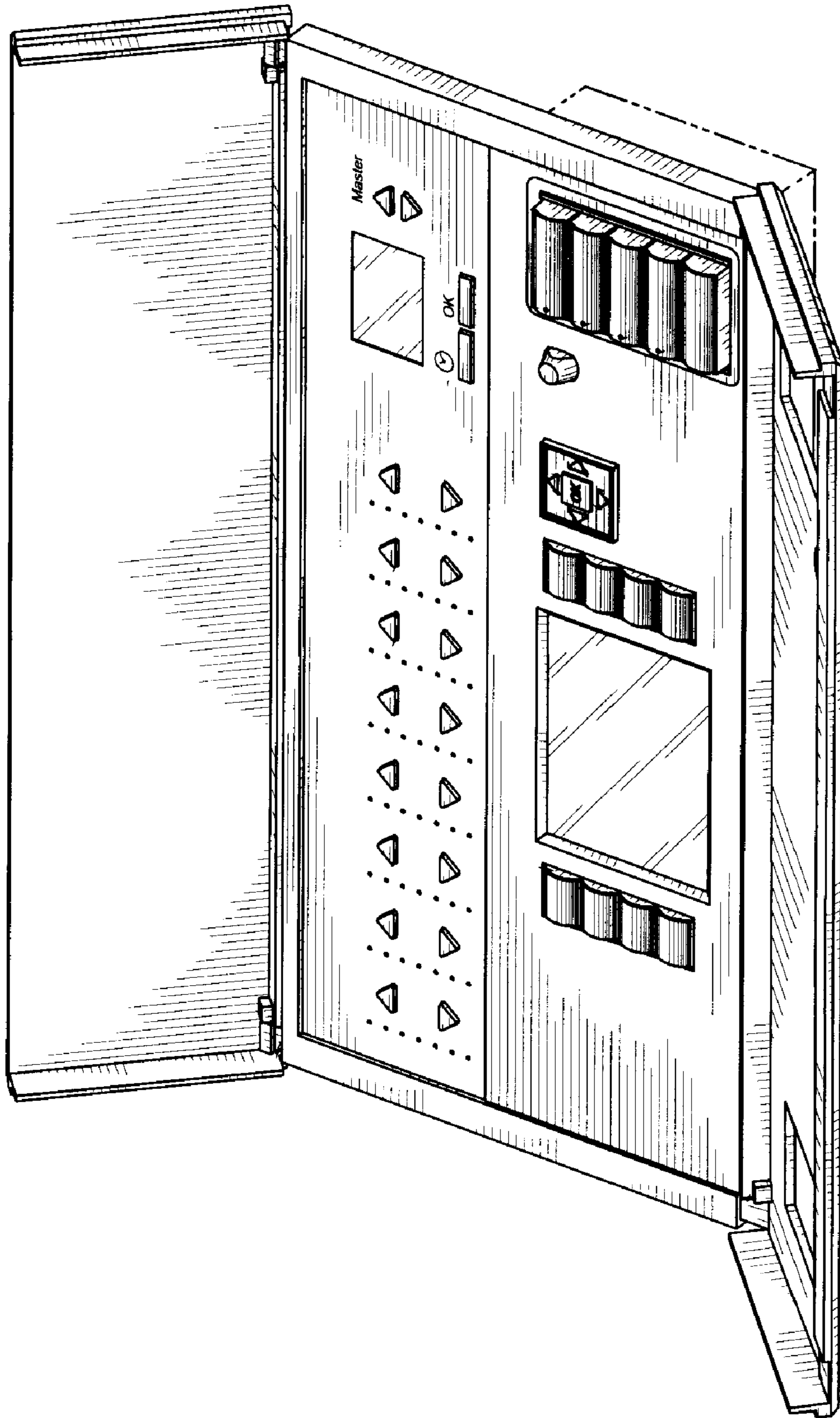

Fig. 11

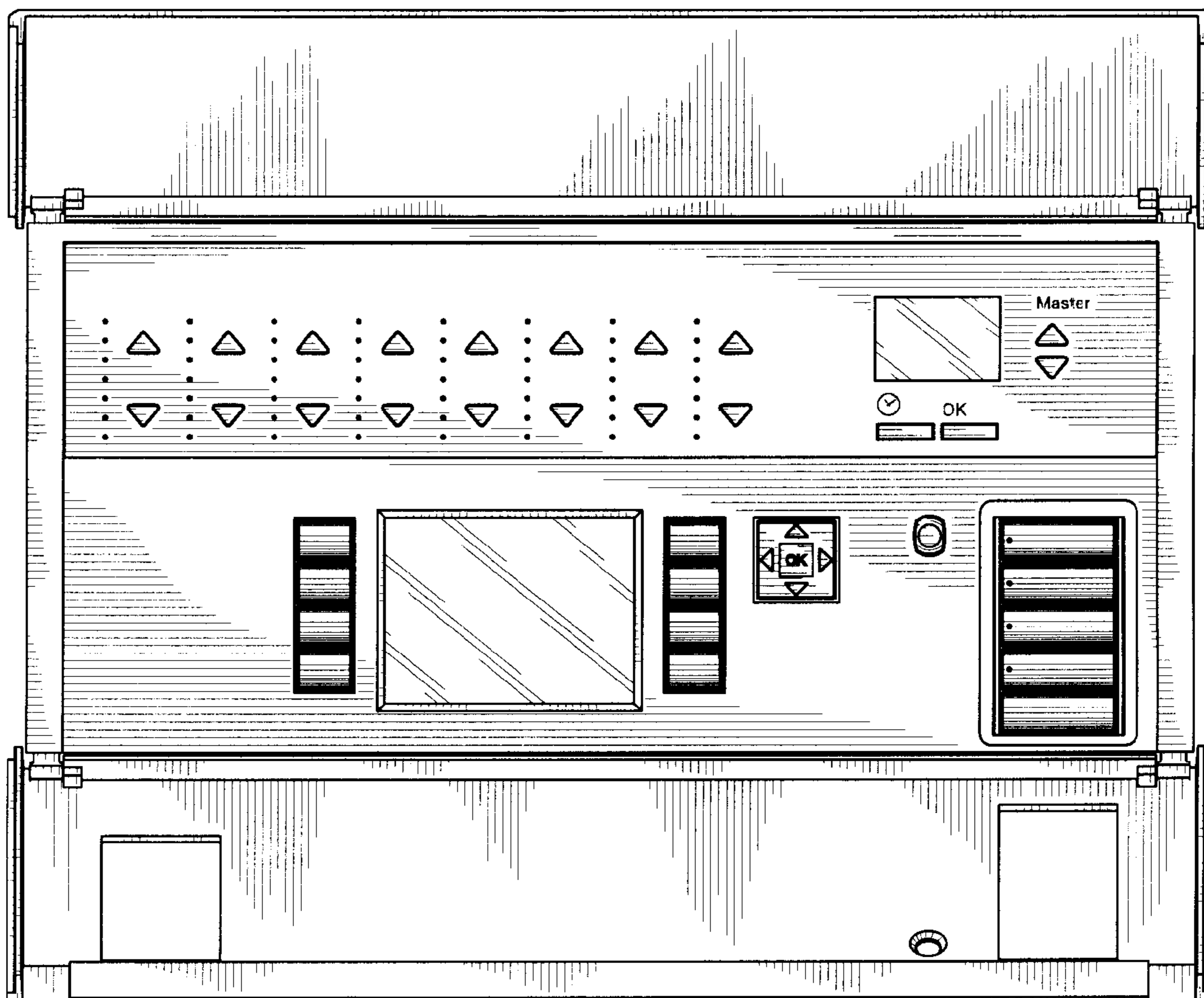

Fig. 12