



US00D573885S

(12) **United States Design Patent**
Considine et al.

(10) **Patent No.:** **US D573,885 S**

(45) **Date of Patent:** **** Jul. 29, 2008**

(54) **CONTAINER**

(75) Inventors: **Guy Considine**, Libertyville, IL (US);
Scott Jost, Naperville, IL (US); **Liam Hawry**, Chicago, IL (US)

(73) Assignee: **Berlin Packaging, LLC**, Chicago, IL (US)

(**) Term: **14 Years**

(21) Appl. No.: **29/282,139**

(22) Filed: **Jul. 12, 2007**

(51) **LOC (8) Cl.** **09-01**

(52) **U.S. Cl.** **D9/528**

(58) **Field of Classification Search** D9/516,
D9/520, 523, 524, 528, 530, 531, 563, 574,
D9/575; D23/211, 211.1; 215/44, 45, 200,
215/243, 329, 379, 380, 382-386, 395, 396,
215/398; 126/640

See application file for complete search history.

(56) **References Cited**

U.S. PATENT DOCUMENTS

D243,656	S	*	3/1977	Hutter et al.	D9/528
4,239,032	A	*	12/1980	Irving	126/640
D279,078	S	*	6/1985	Franchi et al.	D9/528
D284,641	S	*	7/1986	Jones	D9/524
D286,615	S	*	11/1986	Lyons	D9/520
D302,523	S	*	8/1989	Suhajda	D9/528
D377,604	S	*	1/1997	Salmon et al.	D9/528
D391,165	S	*	2/1998	Walker	D9/528
D434,666	S	*	12/2000	Celaya	D9/528
D521,870	S	*	5/2006	Miller et al.	D9/528
D527,639	S	*	9/2006	Voss et al.	D9/528
D538,167	S	*	3/2007	Jennings et al.	D9/528

* cited by examiner

Primary Examiner—Stella M. Reid
Assistant Examiner—Shanda C. Hill
(74) *Attorney, Agent, or Firm*—Adam K. Sacharoff; Much Shelist

(57) **CLAIM**

The ornamental design for a container, as shown and described.

DESCRIPTION

FIG. 1 is a perspective view of a container showing our new design;

FIG. 2 is a right side view thereof;

FIG. 3 is a left side view thereof;

FIG. 4 is a front view thereof;

FIG. 5 is a back view thereof;

FIG. 6 is a top view thereof;

FIG. 7 is a bottom view thereof;

FIG. 8 is a perspective view of a second embodiment of the container;

FIG. 9 is a right side view thereof;

FIG. 10 is a left side view thereof;

FIG. 11 is a front view thereof;

FIG. 12 is a back view thereof;

FIG. 13 is a top view thereof; and,

FIG. 14 is a bottom view thereof.

The broken lines shown in the drawing disclosure are for illustrative purposes only and form no part of the claimed design.

1 Claim, 10 Drawing Sheets

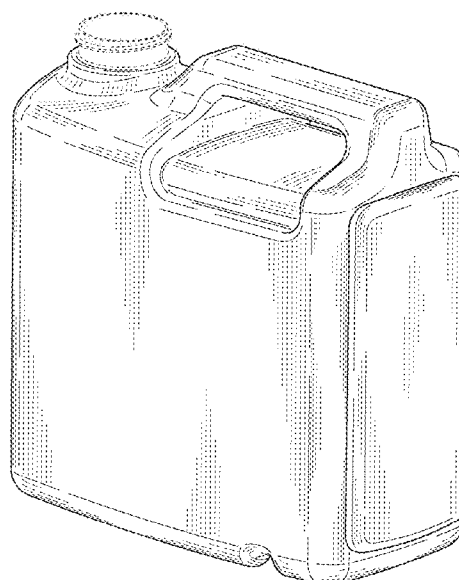
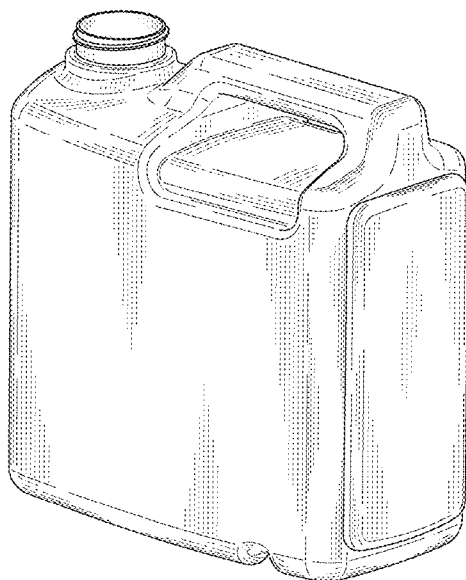

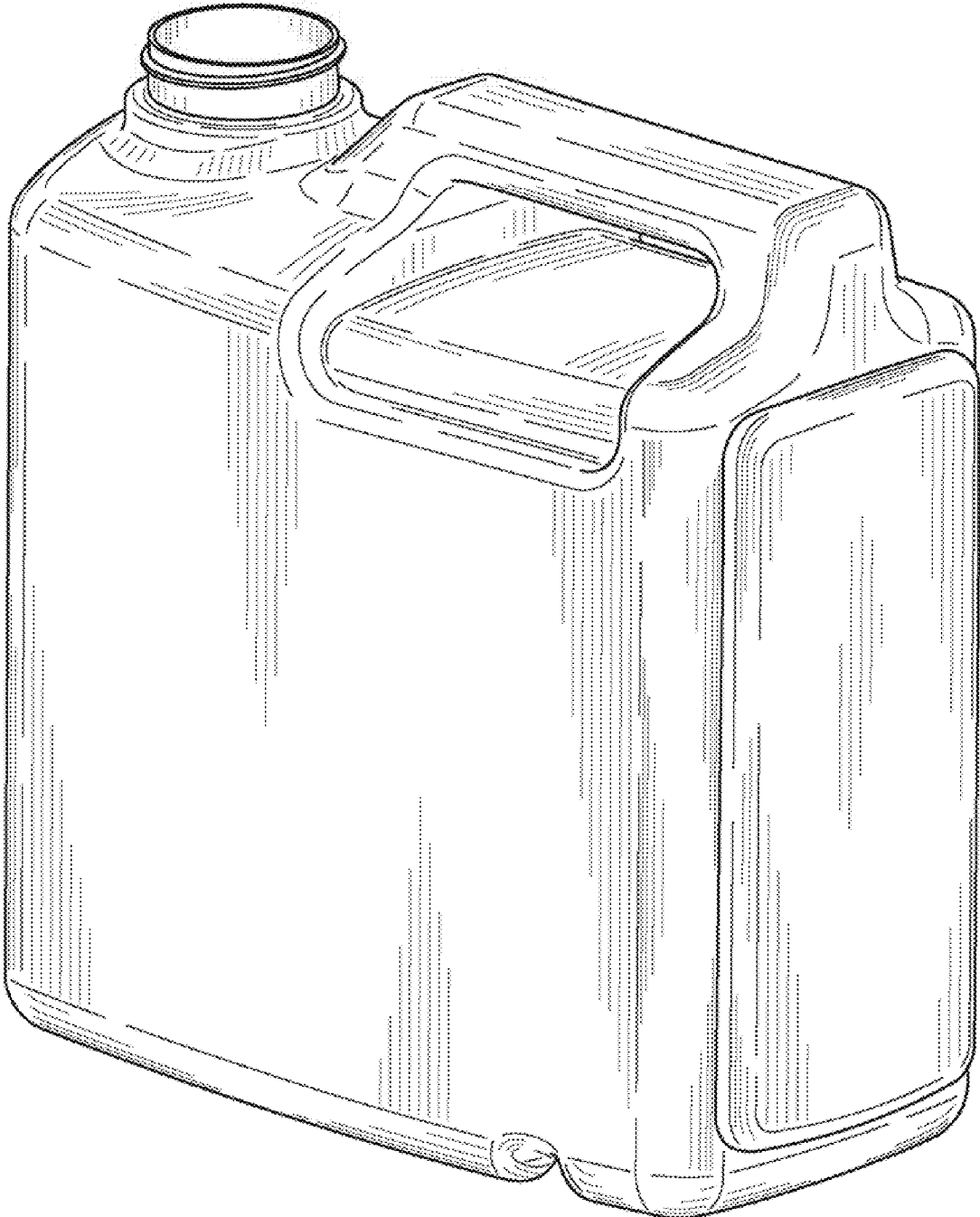

FIG. 1

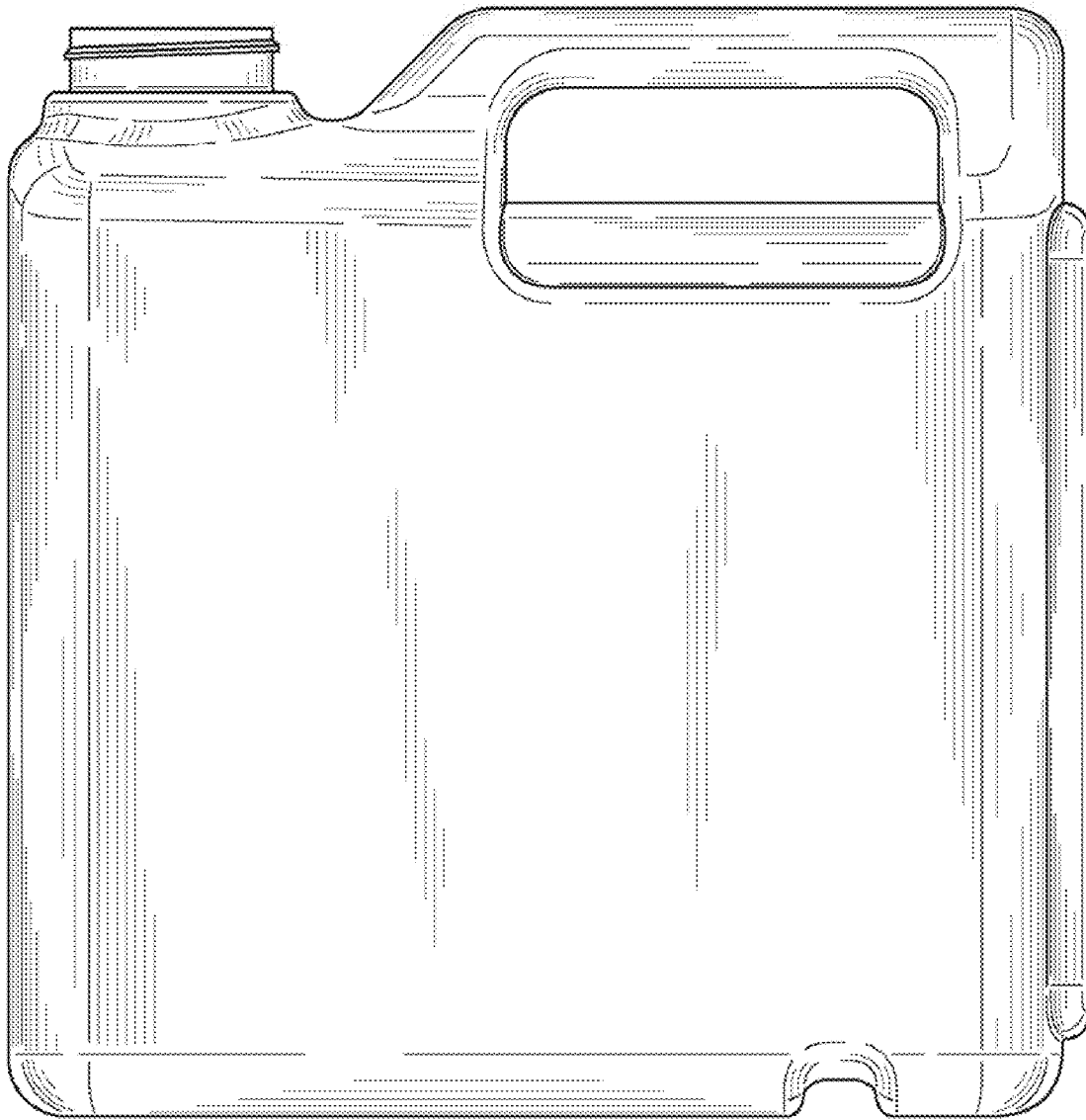

FIG. 2

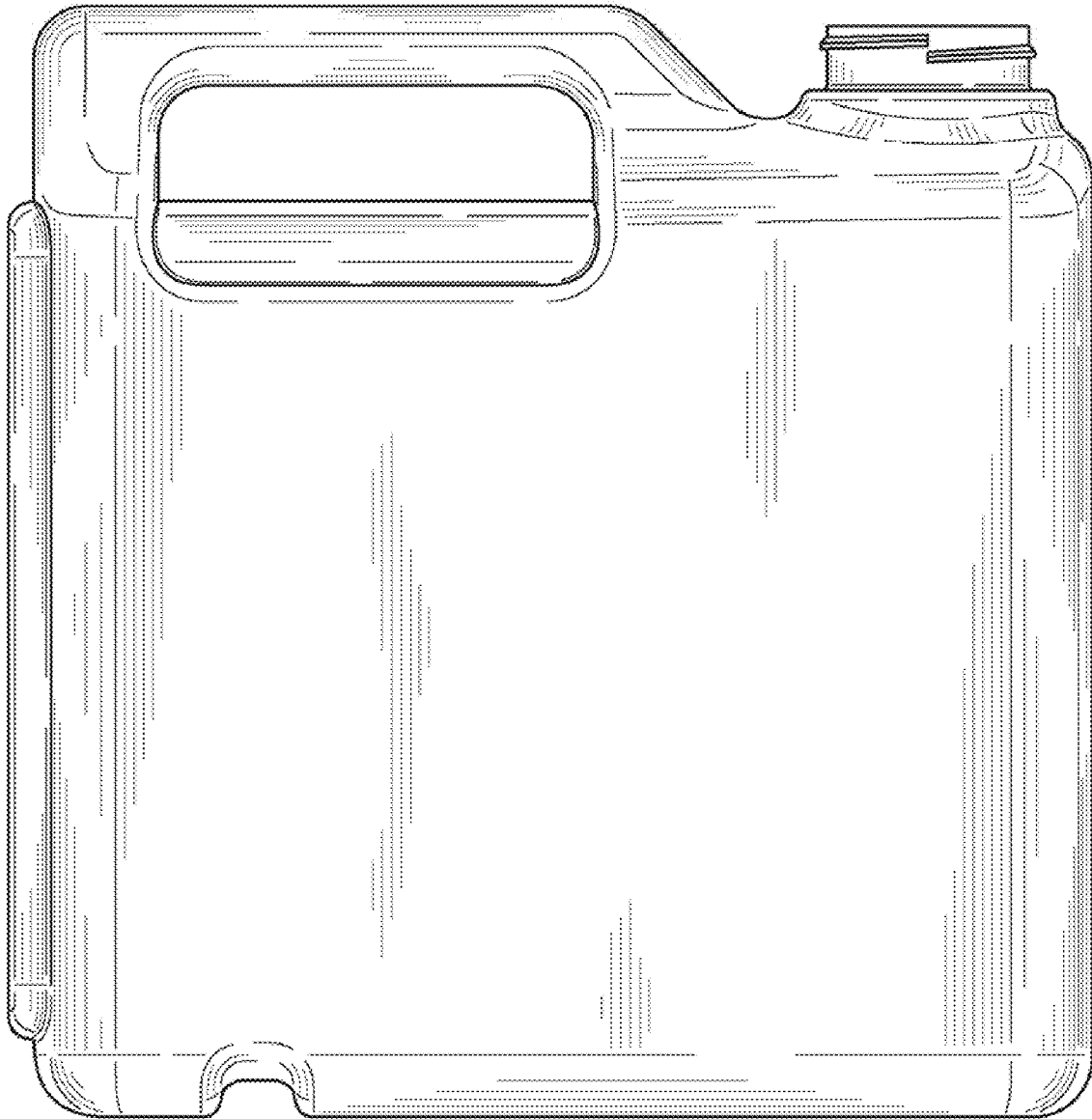

FIG. 3

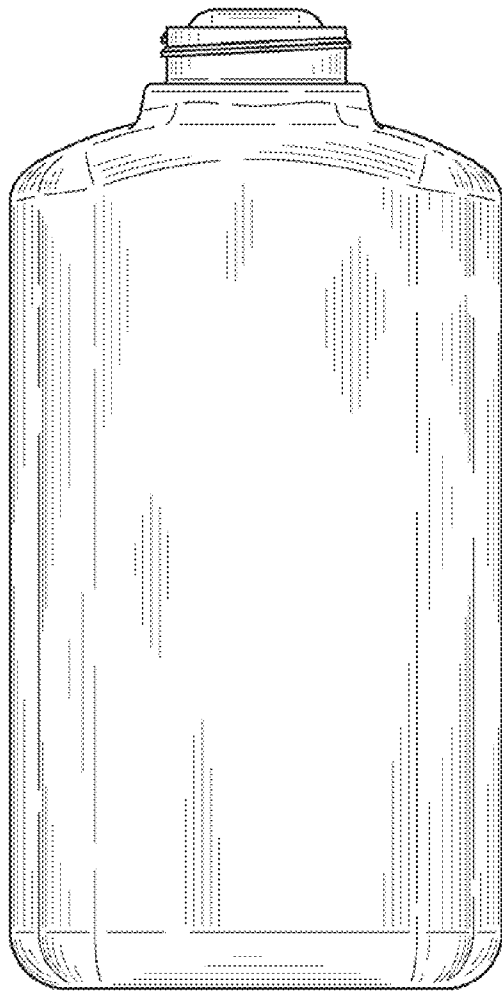

FIG. 4

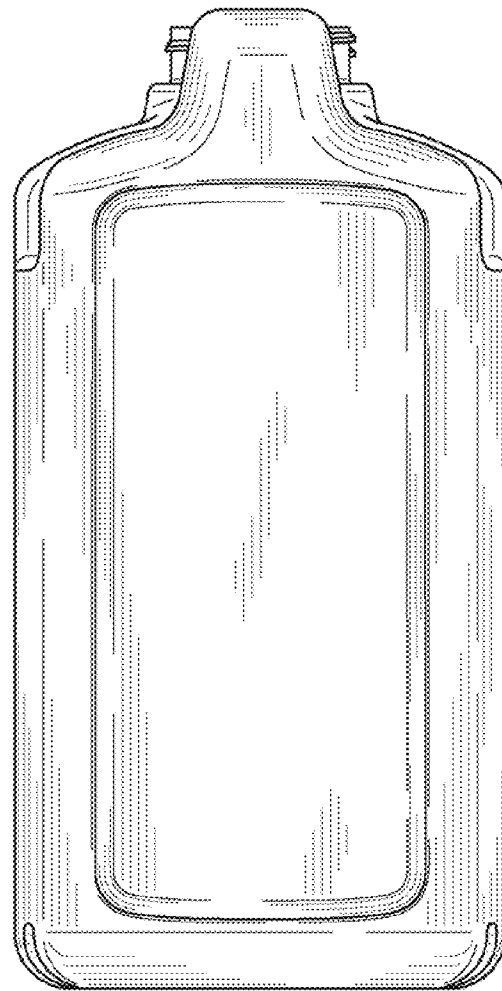

FIG. 5

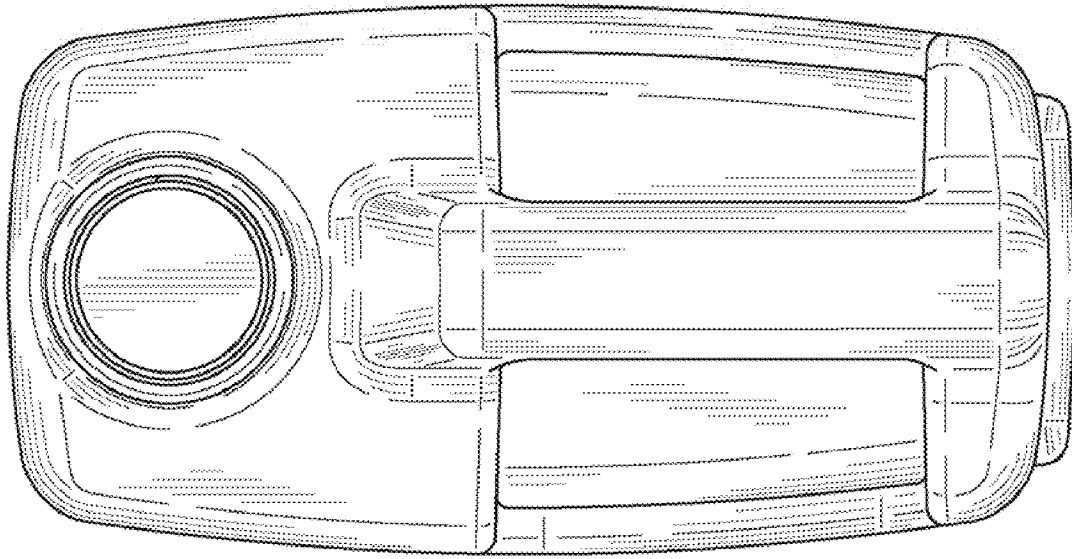

FIG. 6

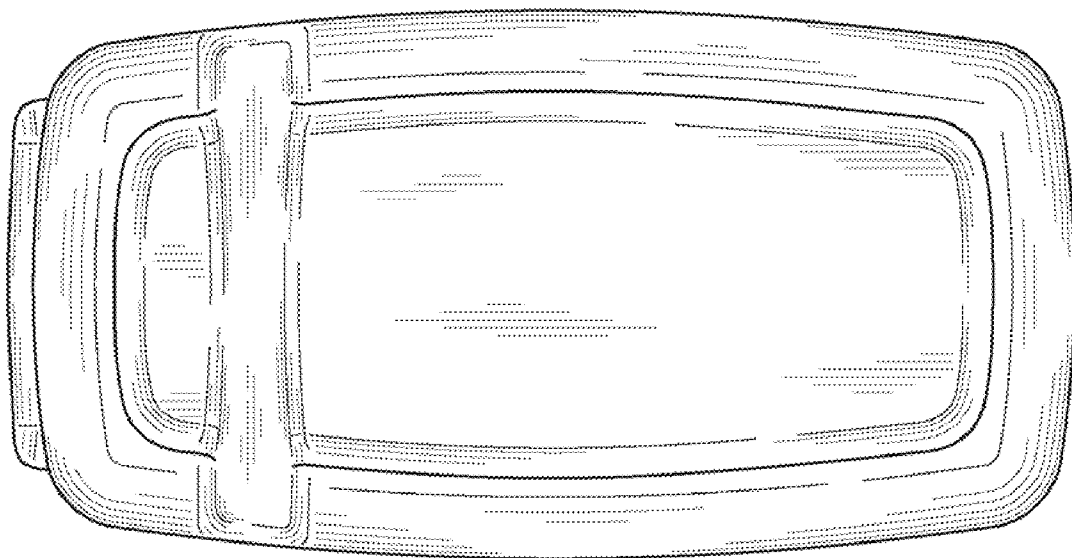

FIG. 7

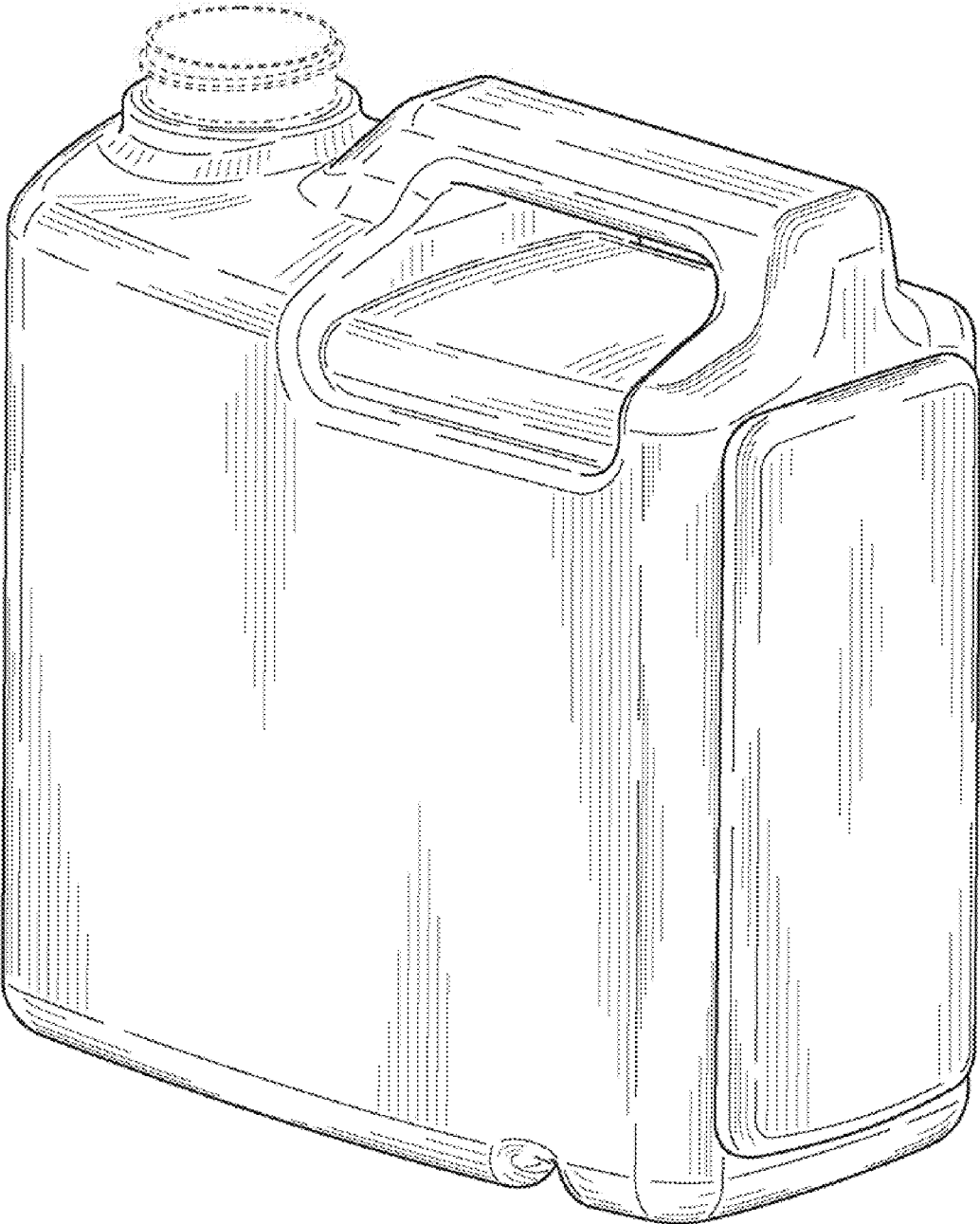

FIG. 8

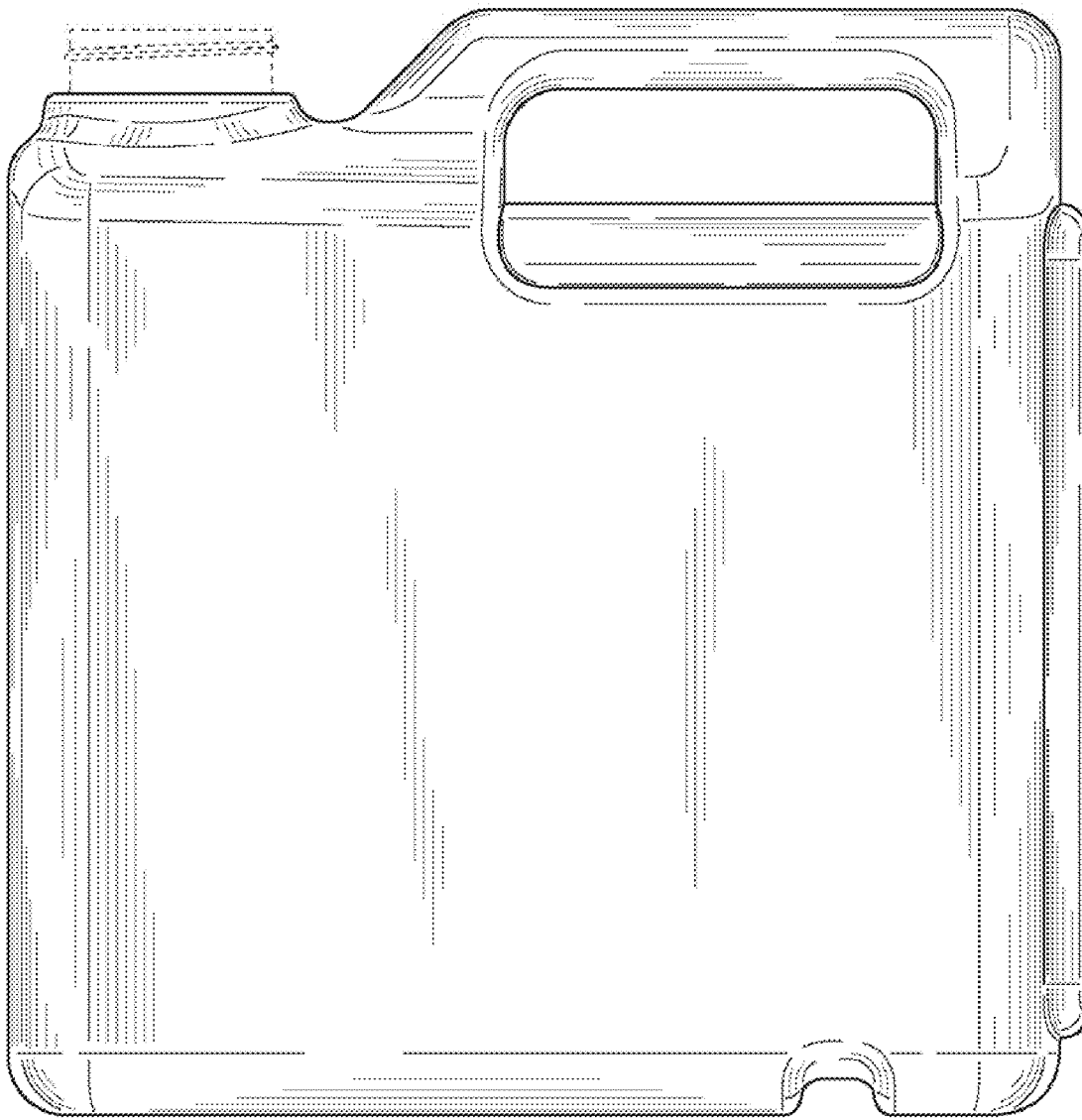

FIG. 9

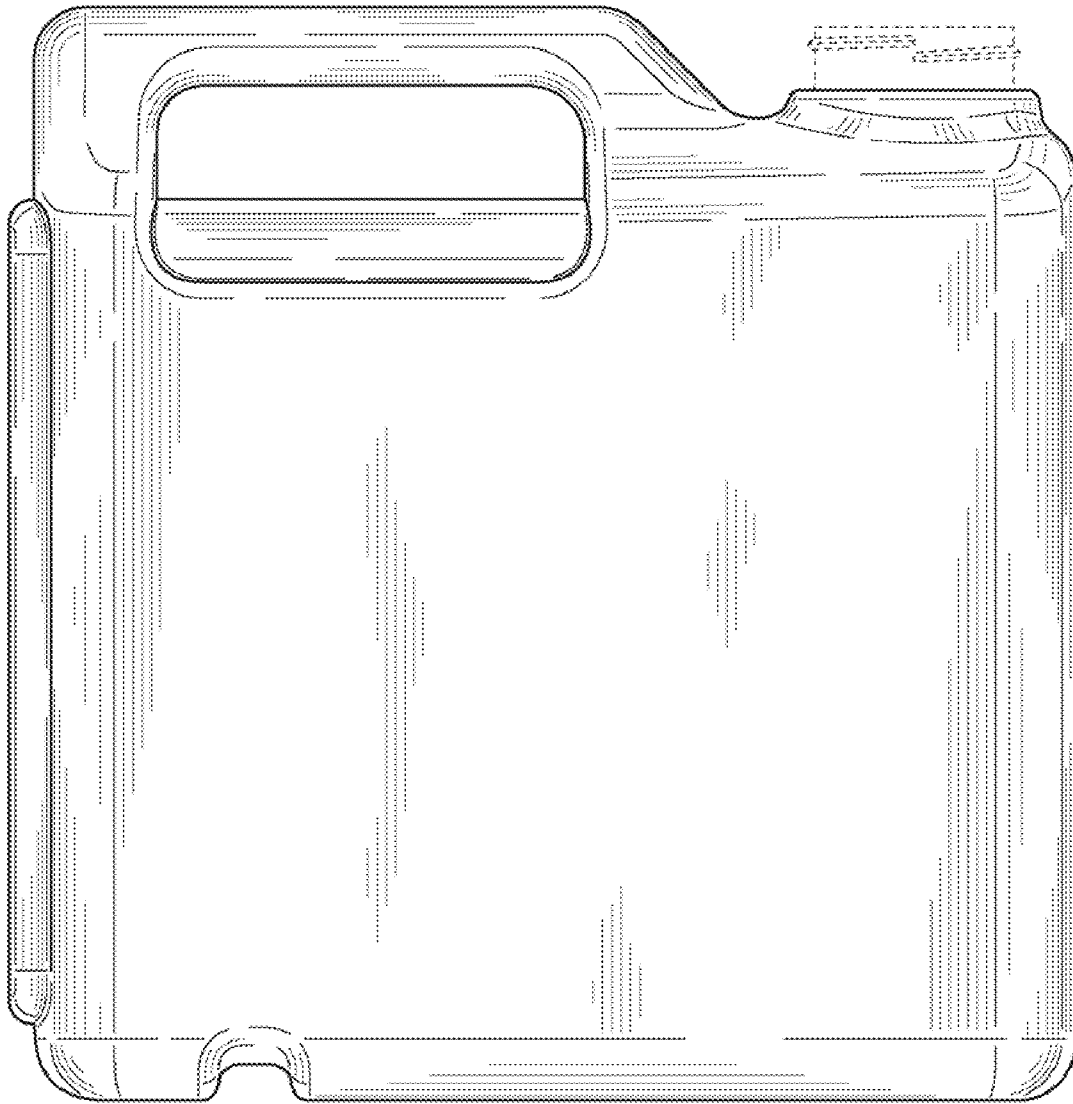

FIG. 10

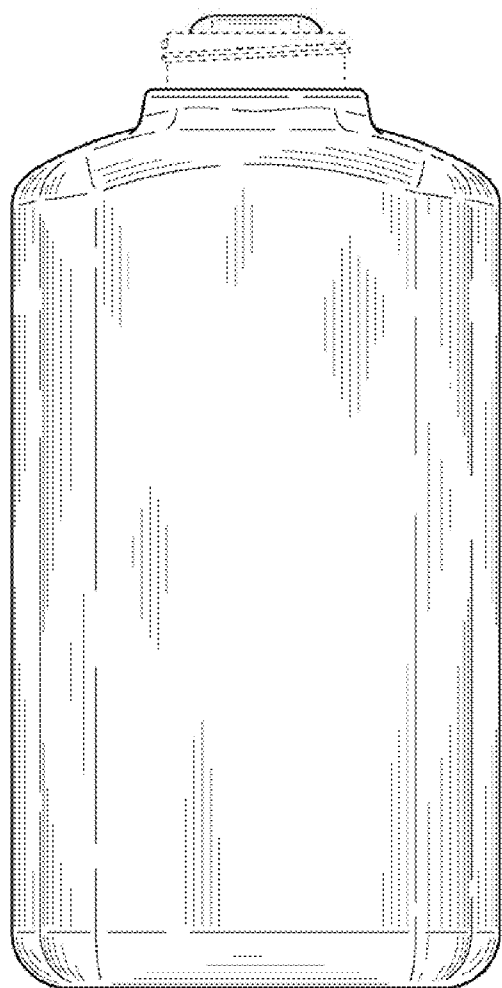

FIG. 11

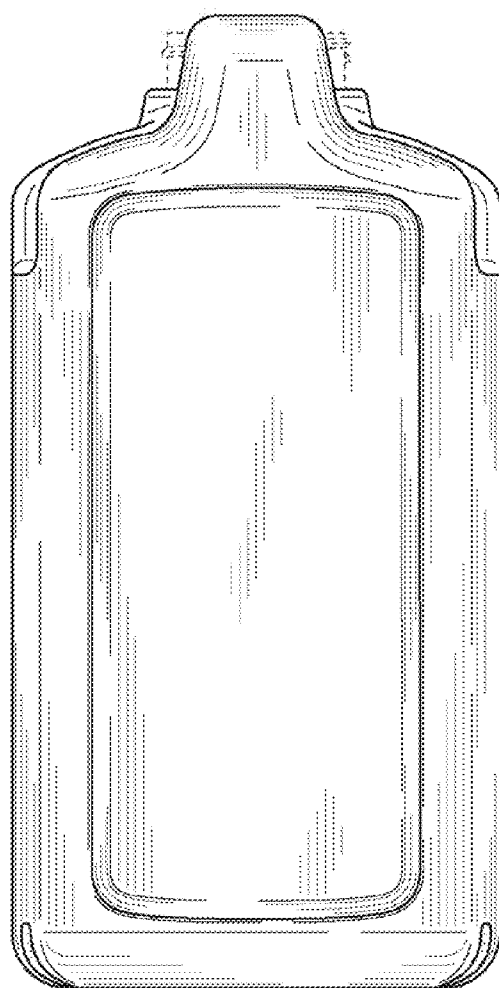

FIG. 12

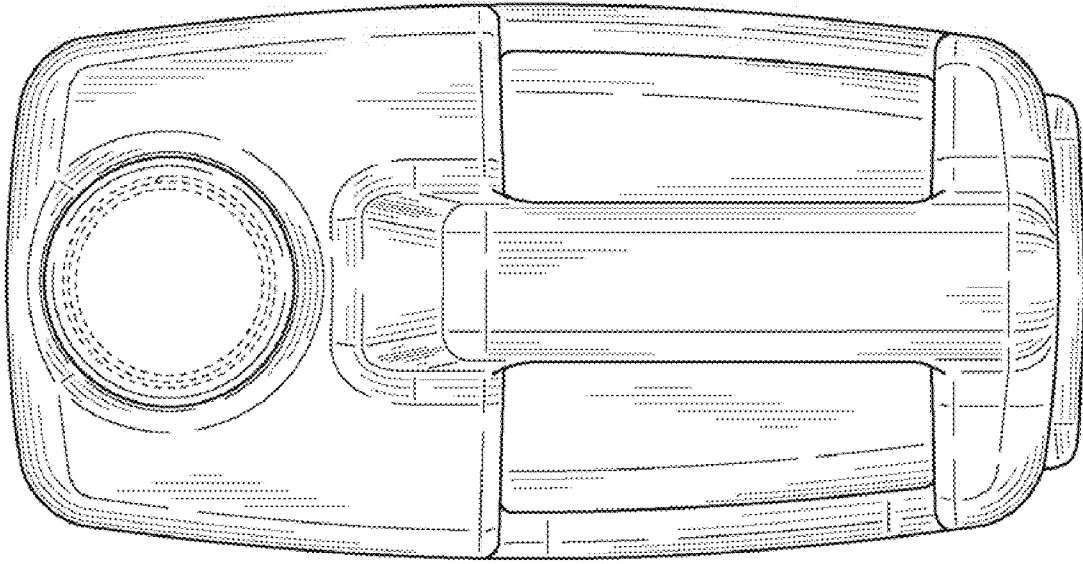

FIG. 13

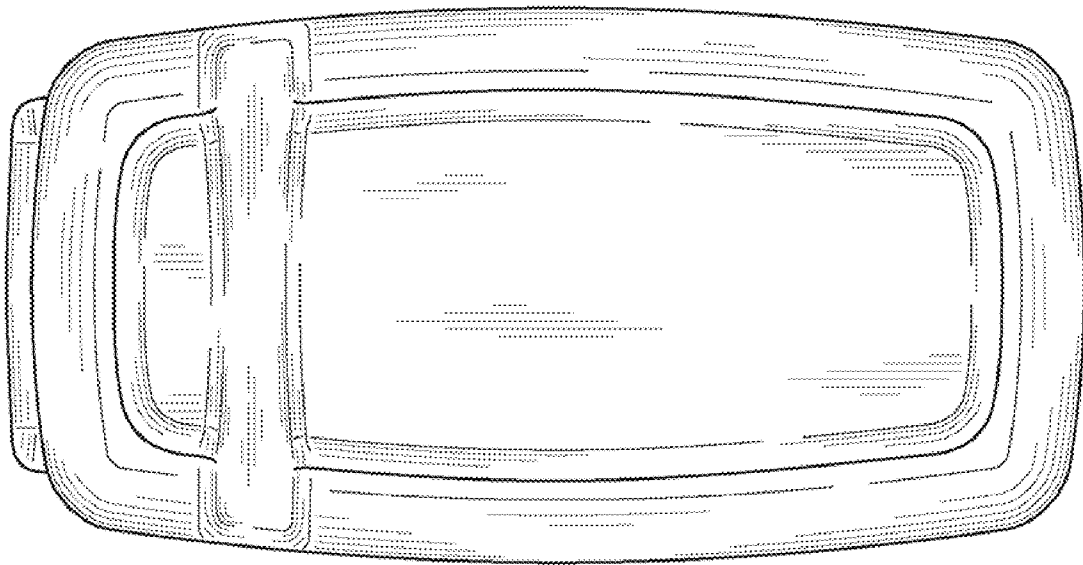

FIG. 14