

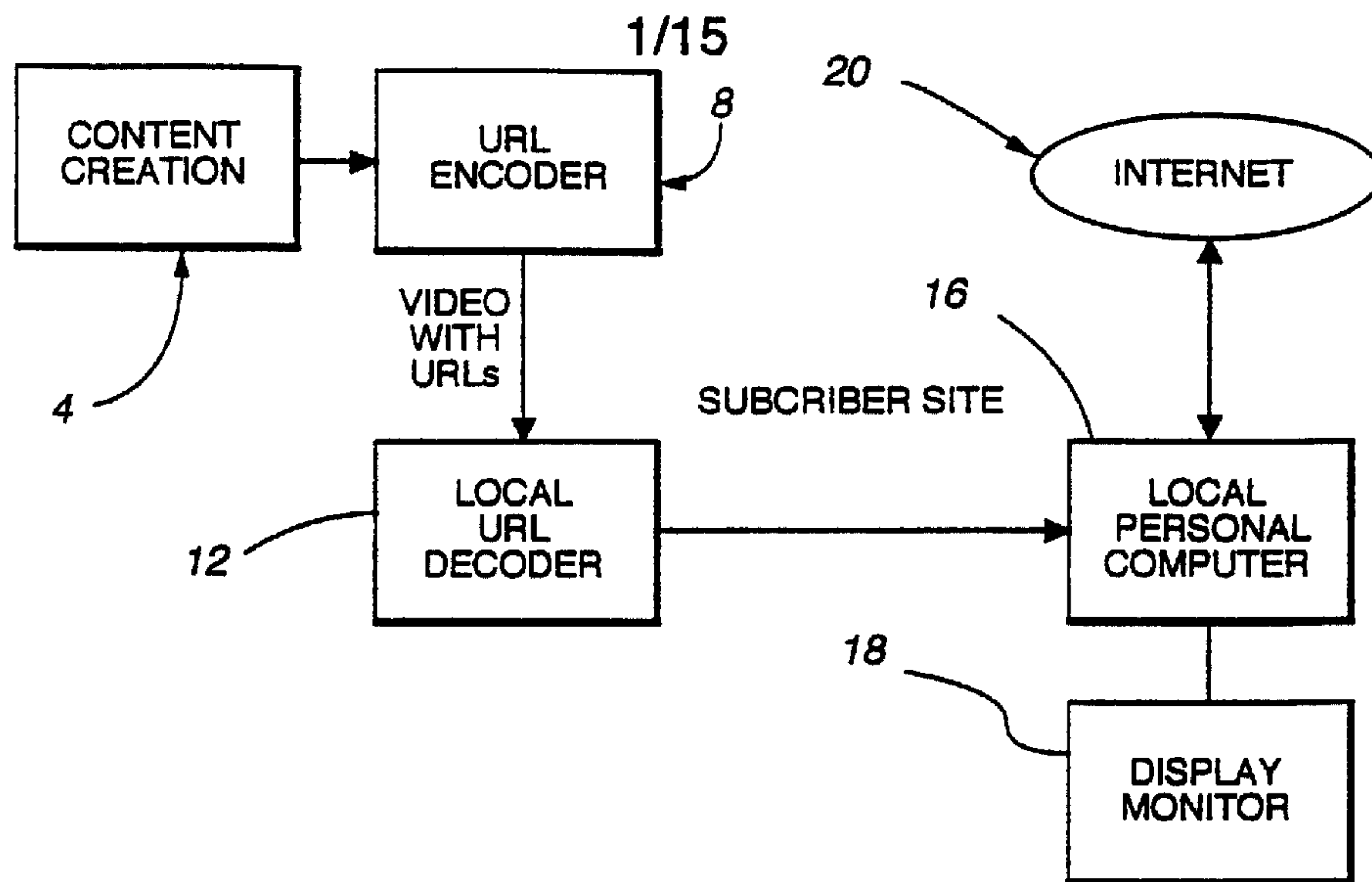

(72) ULLMAN, CRAIG D., US
(72) ABATO, MICHAEL R., US
(72) HARRINGTON, JEFFREY M., US
(72) DUDA, CARL R., US
(71) ACTV, INC., US
(51) Int.Cl.⁷ H04L 12/12, H04N 7/173
(30) 1999/12/16 (09/461,808) US

(54) **SYSTEME DE PROGRAMMATION VIDEO AMELIORE ET
METHODE D'UTILISATION D'UN HOTE LOCAL POUR
RESEAU DE COMMUNICATIONS**

(54) **ENHANCED VIDEO PROGRAMMING SYSTEM AND METHOD
USING A LOCAL HOST FOR NETWORK COMMUNICATIONS**



(57) A local host for network communication. The local host acts as a dummy port in order to avoid certain security restrictions involving use of applets in the JAVA programming language. The local host opens a socket with an Internet or other network connection and functions as a local web server for purposes of the network communication. Also disclosed is a playlist for distributing network addresses to user machines. Based upon time values, the network addresses along with the associated descriptions are transmitted to the user machines. The network addresses may be dynamic by including a variable to be resolved based upon an intended recipient. The information obtained by resolving the variable is used to assemble a completed address, which is then transmitted to the user machines.

ABSTRACT

A local host for network communication. The local host acts as a dummy port in order to avoid certain security restrictions involving use of applets in the JAVA programming language. The local host opens a socket with an Internet or other network connection and functions as a local web server for purposes of the network communication. Also disclosed is a playlist for distributing network addresses to user machines. Based upon time values, the network addresses along with the associated descriptions are transmitted to the user machines. The network addresses may be dynamic by including a variable to be resolved based upon an intended recipient. The information obtained by resolving the variable is used to assemble a completed address, which is then transmitted to the user machines.

**ENHANCED VIDEO PROGRAMMING SYSTEM AND METHOD
USING A LOCAL HOST FOR NETWORK COMMUNICATION**

REFERENCE TO RELATED APPLICATIONS

5 This application is related to the following applications, which are incorporated herein
by reference: U.S. application of Craig D. Ullman, Michael R. Abato, Jeffrey M. Harrington,
and Carl R. Duda, entitled "ENHANCED VIDEO PROGRAMMING SYSTEM AND
METHOD FOR PROVIDING A DISTRIBUTED COMMUNITY NETWORK," application
Serial No. 09/396693, filed 15 September 1999; U.S. application of Jeffrey M. Harrington,
10 entitled "ENHANCED VIDEO PROGRAMMING SYSTEM AND METHOD UTILIZING
A WEB PAGE STAGING AREA," application Serial No. 09/397298, filed 15 September
1999; U.S. application of Craig D. Ullman, Michael R. Abato, Jeffrey M. Harrington, and
Carl R. Duda, entitled "ENHANCED VIDEO PROGRAMMING SYSTEM AND METHOD
UTILIZING USER-PROFILE INFORMATION," application Serial No. 09/409305, filed 29
15 September 1999; and U.S. application of Michael R. Abato and Jeffrey M. Harrington,
entitled "ENHANCED VIDEO PROGRAMMING SYSTEM AND METHOD UTILIZING
SHARED WHITEBOARD," application Serial No. 09/411939, filed 4 October 1999.

BACKGROUND OF THE INVENTION

20 Today, the capabilities of computers to provide massive amounts of educational and
entertainment information has exploded with the Internet. The Internet has the power to
transform society through unprecedented levels of information flow between members.
Currently, on-line systems offer a variety of different services to users, including news feeds,
electronic databases (either searchable by the user directly on the on-line system, or
25 downloadable to the user's own computer), private message services, electronic newsletters,

real time games for play by several users at the same time, and job placement services, to name a few. However, today, most on-line communications occur merely through text. This currently stands in great contrast to the audio/visual presentation of the alternative electronic medium, television. However, it is expected that as multi-media=s incessant growth
5 continues, audio/visual programs will proliferate and text will become less and less dominant in the on-line environment. Even though these programs will be introduced, the Internet, will remain essentially user unfriendly due to its very massiveness, organization, and randomness. Simply stated, there is no order or direction in the Internet. Specific pieces of information are many times hard to find, and harder yet, is the ability to put that piece of information into
10 a meaningful context.

Television, on the other hand, has been criticized for being a passive medium – “chewing gum for the eyes,” as Fred Allen once observed. Television has always been something you watched, not something you do. Many social critics believe that the passivity television depends on has seeped into our entire culture, turning a nation of citizens into a
15 nation of viewers. While interactive television systems have increased the level of user interaction, and thus, provided greater learning and entertainment opportunities, vast information resources such as databases are inaccessible from such a medium.

What is needed is a means to close the gap between video programming and the information superhighway of the Internet. What is needed is a wider, richer experience
20 integrating audio/visual and textual database elements into an organized unique interactive, educational, entertainment experience. Currently, the Internet is a repository of information on virtually any subject. However, what is needed is a mechanism for combining the user-friendly visual experience of television with the vast information resources of the Internet.

What is further needed is a system and method for distributing content with that mechanism combining television programming with Internet resources.

SUMMARY OF THE INVENTION

5 Systems consistent with the present invention combine broadcast television programming and/or video programming which appears on a VHS or Beta tape, CD-ROM, DVD or other medium, or particular content from the Internet, or video programming at a video server (hereinafter "video programming") with the massive Internet, creating a new and powerful educational and entertainment medium. The system allows consumers to receive
10 more information in a more efficient manner than either television or the Internet alone. Consumers not only can see a news report on television, but they can also read pertinent information about the report, as well as explore related information about the story. The program becomes the introduction to a particular subject, rather than the entire subject itself. The act of viewing a program has now become a more engaging, enriching experience.

15 The system can also create a more intimate relationship between the viewer and the program. The user might be solving problems or performing virtual experiments on the Internet site that a teacher is discussing in an educational television program. Similarly, the consumer might be solving problems that the fictional characters in a television program must solve. In both cases, the consumer is an active participant in the process, rather than a
20 passive observer.

 Instead of an undirected and unfocused exploration of Internet sites, by synching specific Internet pages to the video signal, the system puts the Internet in context. The television program producers now can decide what additional information to offer their audience. This material can now be seen in the context of the television program.

An additional advantage is that consumers don't have to search through the literally hundreds of millions of pages on the Internet to find appropriate material. The material has already been filtered by the program producers and delivered to the consumer automatically.

Another advantage of the system is that it changes the nature of advertising. Since
5 additional information can be given to consumers automatically, advertising can now be more substantive, allowing customers to make more informed choices. Now, the act of purchasing a product seen on television can be streamlined -- the consumer can be given the choice of buying the product instantly using the two-way capabilities of the system.

In addition, users can take advantage of the two-way capabilities of the Internet to
10 respond to polls, to send e-mail or to link to additional sites. For example, a viewer watching a television news program, through the system of the invention, can receive a stream of Web pages which provide additional, specific information relating to the news content -- whether background on the Presidential primaries or the latest change in interest rates.

The video programming and corresponding Internet pages can be viewed on personal
15 computers equipped with a television card, but the open software-based approach enables anyone with a television set and JAVA enabled PC to experience the system of the invention.

By marrying the appeal of video with the two-way data transfer capabilities of the Internet, the system creates a powerful new medium: Video producers and Internet site creators can enhance their content to extend their brand identity and differentiate their
20 program offerings to the millions of people who are spending more time navigating through the resources of the World Wide Web rather than watching television; advertisers can speak more directly to consumers by directly sending Web pages to the consumer instead of only displaying Web addresses in their commercials; and consumers can gain a new level of interest and interactivity over a video-based medium. In addition to providing significant and

immediate benefits to broadcasters and advertisers, the system will also present educational programmers with a way to more effectively use Internet resources in the classroom.

Recently, several media companies have joined to create a system for linking the Internet and television on the personal computer, called "InterCast." In this system, content will be provided simultaneously with the TV video signal. This system, however, requires that stripped down Web pages be sent in the vertical blanking interval (VBI) of the video signal, using up to three scan lines limiting effective bandwidth to approximately 28.8 kbps. This approach, however, requires specialized hardware to both insert the Web pages into the VBI and extract these codes at each PC since it takes up to three scan lines of the VBI. Thus, the complexity and cost of the PC is increased. Because the Web pages are transmitted with the video signal, the InterCast system is not a true "two-way" system, but merely a one-way "piggyback" system. In addition, the InterCast is an analog video product, and thus, cannot handle digital video data.

Systems consistent with the present invention, on the other hand, are much more flexible, but less complex, systems. The systems support either analog or digital television broadcasts without broadcasters or end-users having to alter their existing systems, thus enabling broadcasters to reach a wide audience within a short time.

In one embodiment, the actual Web pages are not forced into the very limited bandwidth of the vertical blanking interval (VBI). Instead, merely eight fields of line 21 of the VBI are used to deliver the relevant Internet Web page addresses to the PC. These addresses are called "uniform resource locators" (URLs). The system then directs the particular Web browser to retrieve the identified Web pages from the Internet. Upon receipt of the particular Web page(s), the system syncs the Web page(s) to the video signal, and at the appropriate times, presents the Web pages on one portion of the computer screen with the

television video signal, shown in a window on another portion of the screen, and thus, provides the synergistic Internet and television experience. One of the advantages of the system of the present invention is that no specialized chip set need be produced and implemented into the standard PC. Thus, complexity is kept to a minimum.

5 In another embodiment of the present invention, the VBI is not used to transmit the URLs to the user. In this alternative embodiment, member broadcasters enter the Internet through a member account, and will be provided with a graphical user interface for pre-scheduling Internet addresses, or URLs, for transmission to users at particular times of day. This interface could also be used to transmit real time live transmissions of URLs to users at
10 the same time as a broadcast. The URLs are stored in a "Link File" for later transmission over the Internet to the user at the broadcasters entered time, which corresponds to the broadcast time of an associated program. The timing of URLs could be determined in advance or can be sent out live. This embodiment eliminates the need to place the URLs in the VBI, and also allows the broadcaster to store more than one Link File for transmission to
15 users in different time zones, for example. Further, more than one broadcaster could access the same master schedule if desired, and add or delete certain URLs to personalize the program for their local audiences. Also, personalization can be taken to the single user, or small group of users, by having the system send a different stream of URLs to each user, depending on a unique user profile, for example. Thus, the personalization feature of this
20 embodiment allows each user to receive information uniquely relevant to their interests, demographics, history, etc. This embodiment makes the transmission of URLs to the user even less complex than other embodiments disclosed herein.

Another embodiment permits dynamic reconfiguration of a network for transmitting content, such as that located using the URLs. The network referred to as a distributed

community network, includes hubs that may logically reside on any machine and provide control of routing packets containing the content. By using hubs to assist in routing of packets, the burden of routing control at a corresponding server is decreased, enhancing the reliability and efficiency of the network in transmitting content and permitting access to
5 content.

Thus, embodiments consistent with the present invention provide order and direction to the Internet by using television signals to place, orient and control such information in a meaningful context. They also create a more intimate relationship between the viewer and the program by enriching the learning experience through the provision of more in-depth
10 information.

A method consistent with the present invention uses a local host for network communication. The local host acts as a dummy port in order to avoid certain security restrictions involving use of applets in the JAVA programming language. The local host opens a socket with an Internet or other network connection and functions as a local web
15 server for purposes of the network communication.

Another method implements use of a playlist for distributing network addresses to user machines. The method includes receiving a plurality of network addresses identifying network locations of particular content, an associated description for each of the network addresses, and a time value of a time parameter associated with each of the network
20 addresses. Based upon the time values, the network addresses along with the associated descriptions are transmitted to the user machines. The method may also be used to distribute dynamic network addresses. The dynamic addresses include a variable to be resolved based upon an intended recipient. The information obtained by resolving the variable is used to assemble a completed address, which is then transmitted to the user machines.

BRIEF DESCRIPTION OF THE DRAWINGS

Figure 1 is a diagram of the system design, showing the receipt and decoding of video signals at the subscriber location using the method of the present invention.

5 Figure 2 is a diagram showing an alternative system embodiment to achieve the integration of the Internet information with the video content by decoding the uniform resource locators at a server site and then transmitting the URLs to the subscriber stations via the Internet.

Figure 3 is a flow diagram of the basic software design of the present invention.

10 Figure 4 is a diagram showing another preferred system embodiment to achieve the direct transmission of URLs over the Internet to the user at a broadcaster=s entered time without encoding the URLs into the VBI.

Figure 5 is a diagram of another preferred embodiment including a digital cable box.

Figure 6 is a diagram of another preferred embodiment including a digital T.V.

15 Figure 7 is a diagram of a user interface illustrating a playlist.

Figure 8 is a sample display provided to a student of a lesson.

Figure 9 is a diagram of the distributed Com Server embodiment.

Figure 10 is a diagram of an exemplary logical structure for a local host.

20 Figure 11 is a flow chart of a method for implementing a local host for network communication.

Figure 12 is a diagram of a user interface illustrating display of a playlist to an author of the playlist content.

Figure 13 is a diagram of a user interface for permitting an author to edit content of a playlist.

Figure 14 is a diagram of a user interface for illustrating display of playlist items pushed to a user.

Figure 15 is a diagram of a data structure for playlist entities.

Figure 16 is a flow chart of a method for implementing a playlist.

5 Figure 17 is a flow chart of a method for processing dynamic URLs.

DETAILED DESCRIPTION

Video Programming System and Method

One system consistent with the present invention combines the rich visual capabilities
10 of video with the vast resources of the Internet. As shown in Figure 1, an embodiment of the
invention is a computer based system for receiving a video program along with embedded
uniform resource locators (URLs)--which direct the user's computer 16 to address locations,
or Web sites, on the Internet 20 to retrieve related Web pages. These Web pages correspond
to the video presentation. The particular video programming can be delivered in analog,
15 digital or digitally compressed formats (e.g., MPEG2) via any transmission means, including
satellite, cable, wire, television broadcast or sent via the Web.

The video programming is preferably created at a centralized location, i.e., content
creation 4 as shown in Figure 1, for distribution to subscribers in their homes, for example.
Program creation is accomplished according to any conventional means known in the art.
20 After a video program is created, uniform resource locators are embedded, in one
embodiment, into the vertical blank interval of the video programming by the URL encoder
8, shown in Figure 1. In this embodiment, the URLs are encoded onto eight fields of line 21
of the VBI. Line 21 is the line associated with close captioning, among other things.
However, the URLs could also be embedded in other fields of the VBI, in the horizontal

portion of the video, as part of the audio channel, in any subcarrier to the video, or if digital, in one of the data fields.

Although Figure 1 shows the video with URLs over the same transmission line, the URLs can be sent down independently of the video program on a data channel. In this embodiment, the URLs can be forwarded to the remote sites either prior to initiation or during the program. Preferably, the URLs have associated time stamps which indicate to the subscriber stations when, during the video program, to display the particular Web pages addressed by the URLs. Alternatively, the user can select when to call the particular Web pages for display with the video program.

The particular information in line 21 is not part of the visual part of the program, and thus, is not perceptible to the human eye, thereby making it ideal to send data information to the users. While the bandwidth capacity of line 21 is limited, because the system transmits only the uniform resource locators (URLs), and not full Web pages, there is more than enough capacity. Furthermore, no additional hardware is necessary at the PC 16 to implement the elements of the present invention. Thus, the present invention has the additional advantages of being very efficient and takes advantage of conventional hardware.

Once the video program is created, it can be transmitted to user sites over any transmission means, including broadcast, cable, satellite, or Internet, and may reside on video servers. Furthermore, the video program, with or without embedded URLs, can be encoded on a VHS or Beta tape, DVD or other medium.

Preferably, each receiver station comprises any Intel x86 machine (preferably a 486 processor, pentium processor, etc.), an Apple Computer, UNIX or any other type of standard computer workstation. The local PC 16 is preferably connected to either a cable and/or broadcast television connection or to a local VCR or other video source. At each subscriber

site, the local personal computer 16 preferably receives the cable transmission by cable connection on the back of the personal computer 16. The video/audio program can then be processed for display on the computer screen using any conventional PC card capable of displaying NTSC signals on a computer monitor, such as a WinTV card. In addition to the cable connection, however, in the present invention there is also an Internet 20 connection created concurrently with the cable connection.

The Internet 20 connection can be via high-speed line, RF, conventional modem or by way of two-way cable carrying the video programming. The local PC 16 has Internet access via any of the current ASCII software mechanisms. In one embodiment, at each subscriber home, an associated local URL decoder 12 receives the cable video television program, as shown in Figure 1. The local URL decoder 12 extracts the URLs, preferably embedded in the vertical blanking interval, with the use of any conventional VBI decoder device. The URL decoder 12 may be either a stand-alone unit or a card which is implemented into the personal computer 16.

In another embodiment shown in Figure 2, the uniform resource locators (URLs) are encoded into the video in the same manner as described above. Again, the URLs are preferably encoded onto eight fields of line 21 of the VBI, but may also be sent independently of the video. In this embodiment, the URL decoder 24 is located at the server site, as opposed to the subscriber location. When the decoder 24 receives the video program signal, it strips out the URL codes on line 21 of the VBI and delivers these codes independently to an Internet server 28. The URL code is then subsequently delivered over the Internet 20 to the user PC 16. Simultaneously, the video is broadcast over conventional broadcast or cable transmission means 36 to the user's personal computer 16.

Another embodiment of the system, shown in Figure 4, does not depend on, or even use, the VBI. In this embodiment, the system will run an online service over the Internet 20. This service will be in the form of an Internet Web site 62 that provides a user-interface to a database 78 and to one or more associated data servers 90. The service will provide member-
5 accounts to TV broadcasters 66 who sign up to use the system of the invention in conjunction with their broadcasts. Each member broadcaster will enter the service at their computer 70 through Web browser software 74 using their member account by entering various identification and password information. Once within their account, the member will be provided with a graphical user interface for pre-scheduling URLs for transmission to users
10 118 over a direct Internet connection 94 at particular times of day. The same user interface, or a variation on it, can be used by broadcasters for live transmission 82 of URLs to users at the same time as a broadcast 86.

For example, one example of this interface might be a scheduling calendar (daily, weekly, monthly, yearly) in which the broadcaster 66 may allocate time periods which
15 coincide with their broadcasts 86, and during which they will send out URLs to their users to link to Web pages. For each time period (for example, a particular hour long period during the day) determined by the broadcaster 66 to be a broadcast period (a period during which they want to transmit URLs that correspond to a television show being broadcast from their TV broadcast facility 110 to the external TV 114 of the user 118 at that time), the broadcaster
20 66 may then enter a series of URLs into an associated file ("Link File") for transmission over the Internet 20 at that time. This Link File might have a user interface such as a spreadsheet, table, or list, or it could be simply a tab-delimited or paragraph-delimited text-file. As an example, each of the records in the Link File consists of a data structure which could contain information such as:

(<timecode>,<URL>,<label or title>,<additional information>,<additional information>,...)

The above data structure is just one example. The records in the Link File preferably specify the time, Internet address (i.e. URL), label (such as an associated name), and some
5 optional additional information, for each Web page the broadcaster 66 desires to launch during a show.

When a broadcaster 66 modifies their calendar and/or the Link File associated with any given time period(s) in their calendar, this information is saved into the database 78 that is attached to the site 62. Each broadcaster 66 may maintain multiple calendars in the
10 database 78 if they broadcast in different time zones, for example.

The database 78 provides the Link File records for upcoming time periods to a server 90, which may be one server or a distributed network of server programs on multiple computers across the network, to be utilized for scaling to large national or global audiences.

The server 90 provides the Link File records, including the URLs, to the user's personal
15 computer 16, which is connected via a network. Examples of possible networks include the public Internet 94, a direct private network, or even a wireless network.

One feature of the above embodiment is that one or more broadcasters 66 may utilize the same schedule in the database 78 for their own broadcasts 86 or during the same broadcast. For example, a network broadcaster may develop a master schedule and various
20 affiliate broadcasters may subscribe to that schedule or copy it (in the database) and add or delete specific URLs in the schedule for their local audiences or unique programming. This scheme enables affiliates to insert URLs for local advertisers or local subjects into a sequence of more general URLs provided by their network broadcaster 66. In other words, the affiliate can add links that ride on the network feed and then redistribute it to their local audiences.

This embodiment can also enable personalization in the form of unique series of URLs specific to each user's unique profile, which is directly sent over the Internet 20 to each user's specific client software 106. This can be achieved from the broadcaster 66 to each individual user 118, or to particular collections of users. To accomplish personalization, the service may send a different stream of URLs to each user's client software program 106. The stream of URLs sent would depend on a user profile stored in the database 78 or the client software program 106, a user profile which is built on demand or over time for each user 118 based on criteria such as the location of the user, choices the user makes while using a client software program 106, or choices the broadcaster 66 makes during a broadcast 86, or automatic choices made by an algorithm (such as a filter) residing on the service 62. Personalization enables each user to receive URLs which are uniquely relevant to their interests, demographics, history, or behavior in the system.

System Operation

Once the URLs have reached the personal computer 16, system operation is similar for all of the embodiments diagramed in Figures 1, 2, and 4.

In one embodiment, a JAVA enabled browser 98 as well as specialized software 106 for performing part of the method of the present invention are installed on the computer 16. The JAVA enabled browser 98 allows the computer 16 to retrieve the Web pages 102 and is preferred software, since it is platform independent, and thus, enables efficient and flexible transfer of programs, images, etc., over the Internet 20. The specialized interface software 106 (hereinafter, "client software"), attached as Appendix A, acts as an interface between the video programming and the Internet functions of the present invention. The client software 106 retrieves URLs from the video program (embodiment of Figure 1) or directly from the Internet connection (embodiments of Figures 2 and 4), interprets these URLs and directs the

JAVA enabled browser 98 to retrieve the particular relevant Web pages 102, and synchronizes the retrieved Web pages to the video content for display on the user's computer 16, as shown in Figures 3 and 4 and explained in more detail below.

In one method, the URLs are encoded and embedded into the video signal by inserting them into the vertical blanking interval (VBI), as mentioned above.

In another embodiment, the URLs are entered by member TV broadcasters 66 along with specified times for transmitting the URLs to the user. At the appropriate times, the URLs are sent directly over the Internet to the user's PC 16 via the client software 106 over a direct point-to-point or multicasting connection.

One method of the present invention has the capability to detect identical URLs sent directly after one another which causes the browser not to fetch URLs in these particular cases. As shown in Figure 3, once the URL code is received at the computer, the client software 106 first interprets the URL and determines in step 42 whether the particular URL has been received previously. If it has already been received, the next received URL is interpreted for determination of prior receipt. If the particular URL has not been detected before, the software checks for misspelling in step 46 and any other errors, and if errors exist, corrects these particular errors. Once again, it is determined whether the URL has been previously detected. If it has, the next URL is accessed in step 38. If the URL has not been detected, the specific URL is added to the URL list in step 54. The specific URL is then sent to the Web browser, preferably a JAVA enabled browser 98. Upon receipt of the URL, the browser 98, in step 58, will access the Web site address 122 (Figure 4) indicated by the URL and retrieve the cited Web page(s) 102 via the Internet.

Viewers can view the integrated presentation in the following manner. As mentioned above, the video signal is processed and displayed on a video window on the PC screen using

a WinTV card, for example. The corresponding audio is forwarded to the audio card and sent to the PC speakers.

The actual retrieved Web pages 102, referenced by the URL, are optionally time stamped to be displayed on the computer screen when predetermined related video content is displayed in the video window, thus, enlightening and enhancing the video presentation by providing in-depth information related to the video content thereto. Another section on the screen is also preferably used to represent an operational control panel. This control panel provides a list of the URLs that have been broadcast and correspondingly received by the computer 16. This control panel is updated to add a URL code each time a new URL code is received by the PC 16. This list gives the subscriber the flexibility to go back and retrieve particularly informative or interesting Web pages that have already been displayed earlier in the program, or alternatively, to print them out for future reference. Furthermore, the list could include URLs referring to Web pages not displayed with the broadcast program, but that provide further information on a certain topic of interest to the viewer.

An exemplary implementation of the present invention can best be understood with reference to an example. A viewer can begin watching a musical video featuring a new band, for example. As the video is received by the PC 16, URLs are either being received with the video signal or are being received directly via the Internet 20 or another data channel, and are being interpreted by the client software 106. Upon direction and command, the JAVA enabled browser 98 retrieves particular Web pages 102 from Internet 20 Web sites identified in the URLs. These Web pages 102 will then be displayed on the video screen at particular times. Thus, for example, while the viewer is watching the music video, biographical information on the band can also be displayed adjacently to the video window. Web pages 102 could also include an upcoming concert schedule, or even audio clips of the band's music

may be downloaded from the Internet 20. As another example, a user could be watching a program relating to financial news. While the narrator is shown discussing high tech stocks, Web pages corresponding to detailed financial performance information on high tech stocks, environment and characteristics can be displayed with the video on the computer screen. If the personalization features are included, Web pages associated with a particular user's stock can be fetched and displayed on the computer screen with the video program. When the program narrator switches to a discussion on the weekly performance of the Dow Jones, Web pages presenting related financial performance information can be simultaneously displayed. Thus, it is evident that the present invention profoundly enriches the viewing and learning experience.

It is understood that there can exist alternative embodiments for use with the present invention. For example, the user can view the interactive program using a television set 114 or other display monitor in conjunction with the display screen of the personal computer 16. In this embodiment, the relevant Web pages are shown on the personal computer 16 while the video program is displayed on the television monitor 114. In this alternative embodiment, a cable set top box receives the television program from the multichannel cable. The personal computer 16 also receives the video program from the multi-channel cable and extracts the URLs, embedded in the vertical blanking interval of the video signal or directly transmitted 94 over the Internet 20. The client software 106 extracts the URLs and retrieves the particular Web pages as described above. The Web pages are then synchronized with the particular video frames and presented to the user. It is understood that a hyperlink may exist on the Web site that will allow the user to automatically load the client software and call up the specific television channel referenced in the Web site. For example, someone browsing the Internet 20 may come upon a major television network's Web site. They scroll to an

interesting story then click on an hyperlink to turn on the software which tunes the TV window to the network to enhance the information residing at the Web site.

Furthermore, instead of receiving the video program from a transmission means, the video program can be addressed directly from the user site if the video program, with or
5 without embedded URLs, is stored on a VHS, Beta, DVD or other medium. In this embodiment, the user PC 16 and/or television 114 are connected to a VCR, DVD player or other appropriate device.

Figures 5 and 6 show two alternative embodiments for use with the present invention. For example, the user can view the interactive program using a television set 18 or other
10 display monitor in conjunction with a digital cable box 140, as shown in Figure 5. In this embodiment, the digital cable box 140 performs the functions of the personal computer 16 shown in Figures 1, 2 and 4. In the embodiment shown in Figure 5, the client software is stored in memory in the digital cable box 140. In one embodiment, the digital cable box 140 includes two tuners, thus allowing both the Web Page and the Video program to be
15 simultaneously viewed on the same screen. If Video and Webstream, however, are carried on one channel, then only one tuner is necessary.

The client software retrieves URLs from the received video program, directly from the Internet connection 20 or via a separate data channel, interprets these URLs and directs the Web enabled browser to retrieve the particular relevant Web pages, and synchronizes the
20 retrieved Web pages to the video content for display on the television 18, as shown in Figure 5. In this embodiment, the relevant Web pages are preferably shown in one frame of the television 18 while the video program is displayed in another frame. Alternatively, the web page can replace the video program on the display.

In this alternative embodiment, the digital cable set top box 140 receives the television program from the multichannel cable. The URLs can be encoded into the digital program channel using MPEG 1, MPEG2, MPEG4, MPEG7 or any other compression video scheme. Alternatively, the URLs can be transmitted to the digital cable boxes 140 from an Internet server 148. The digital cable box 140 decodes the URLs from the digital video signal or directly transmitted over the Internet 20. The client software decodes the URLs and retrieves the particular Web pages as described above. The Web pages are then preferably synchronized with the particular video frames and presented to the user.

As with all the embodiments described above, instead of receiving the video program from a transmission means, the video program can be addressed directly from a local video source 144 if the video program, with or without embedded URLs, is stored on a VHS, Beta, DVD or other medium. In this embodiment, the digital cable box 140 is connected to a VCR, DVD player or other appropriate device.

Figure 6 discloses an embodiment where a digital TV 152 is the remote reception unit. In this embodiment, the digital TV 152 performs the functions of the personal computer, shown in Figures 1, 2 and 4, and the digital cable box 140 shown in Figure 5. In the embodiment shown in Figure 6, a processor means and memory are incorporated into the digital TV 152. Further, the client software and Web browser software are implemented into memory in the digital TV 152. All of the functions described above with reference to the other embodiments are performed in a similar manner by the digital TV 152 embodiment.

Although the digital cable box/TV 140, 18 and digital TV 152, shown in Figures 5 and 6, are incorporated into the embodiment of Figure 1, in substitution for the PC 16, they also could be substituted for the PC 16 shown in Figures 2 and 4.

The user can view the video and web content on one screen (in two windows), or with the video on one display screen and the Web content on a separate display monitor.

Alternatively, the user can access the video or web content separately. Thus, the user can branch from video to web content and vice versa.

5 The present invention is well-suited to the education environment. In this embodiment, students and teachers access one or more Web servers. The software components include instructor and student user software, authoring software and database assessment software. In one such embodiment, an instructor uses content creation software on a personal computer to easily integrate into their curriculum current information published
10 on the Web, through an easy to use interface 156 such as that shown in Figure 7. The instructor creates a playlist (i.e. linkfile) 160, the playlist 160 comprising a listing of Web pages, text notes and questions. The Web sites and questions are set forth in a predetermined order and can be assigned times. Preferably, the URLs identifying the Web site and time stamps are sent automatically to the desktop of each student in the virtual community, either
15 during playback of a pre-recorded program or during a live event.

At each of the student workstations, the program is directed by the playlist 160. In other words, the playlist 160 provides the structure for the program. At predetermined times as dictated by the playlist 160, the browser will go fetch and display a Web page in a frame on the computer screen. Because program events can be set up in this manner at
20 predetermined times, the entire program and playlist can be prerecorded and stored in a Web database for later access by students.

A significant advantage of an embodiment for educational applications is that the students and the instructor can be located anywhere, as long as they are all connected to the

Web. Because a server is essentially controlling the program, the instructor output comes from the server and the student workstations get automatically updated by the Web server.

This educational embodiment integrates Web content and other media with collaborative groupware functionality to create an interactive environment for students and teachers. In this embodiment, the student can receive a traditional video lesson through a frame in his or her Web browser, or from a television. Simultaneously, the present invention provides separate frames, an example of which is shown in Figure 8, in the browser displaying: (1) Web pages 176 automatically delivered to each student's desktop with information or exercises that complement the video presentation; (2) a chat dialogue frame 168 for conversing with the instructor and/or other students online; and (3), an interactive playlist 164 of Web pages and questions comprising the lesson.

In the student interface of Figure 8, each student can perform a virtual experiment during a physics lesson to learn about gravity, for example. Further, the students are conversing with one another and the instructor in the chat dialogue frame 168. They may also send Web pages to one another and provide answers to questions from the teacher via the chat dialogue frame 168 of the student interface 176. With the chat feature, students may break into subgroups for collaborative learning. Whenever a student in the group sends a message, the message is sent to the Internet server 20 and every other student in the subgroup receives and views the message in their Chat dialogue frame 168.

The instructor, however, may retain control over the chat feature. For example, the instructor can terminate the chat feature or web pushing to terminate unruly on-line conversations or the sending of Web pages by students.

Unlike conventional distance learning systems, systems consistent with the present invention are more powerful by allowing the instructor to freely and conveniently exercise

almost any type of testing strategy. The instructor can test students using a combination of the Chat dialogue feature and Web pages. For example, multiple choice questions and short answer questions can appear in the Chat window 168. Essay questions, requiring longer answers, become Web pages. As mentioned above, students can perform virtual experiments on-line. Once the instructor's personal computer receives student answers, student scoring can be presented to the instructor in any format including tables, charts, diagrams, bar graphs, etc. The instructor, thus, can analyze the results and has the capability of providing real-time feedback to the students.

Students can also receive individualized feedback via branched interactive audio, video and/or graphics responses. For example, the workstation may branch to a particular audio response, preferably prerecorded in the instructor's own voice, based on the student response to a multiple choice question. In this embodiment, a plurality of potential audio responses are made available at the student's workstation according to any one of the methodologies set forth in U.S. Patent No. 5,537,141, entitled DISTANCE LEARNING SYSTEM, herein incorporated by reference. Alternatively, personalized video, audio and graphics segments can be delivered and displayed to the student based on a student answer or personal profile in the manner set forth in U.S. Patent No. 5,724,091, entitled COMPRESSED DIGITAL DATA INTERACTIVE PROGRAM SYSTEM, herein incorporated by reference.

Responses to student answers can be more substantive based on the memory feature of the system. The memory feature is an algorithm that selects an interactive response to the user based not only on the student's current answer selection, but also his or her previous responses, as discussed in the aforementioned applications. The algorithm, preferably stored in memory at each student's workstation and under processor control, merely selects an

output interactive response based on student responses. As another example, if a student gets three answers in sequence right, he or she receives a more difficult question. If, however, the student misses one or more of the three questions, he or she receives an easier question.

In another embodiment of the present invention, a system is described capable of
5 handling the education requirements of several schools in an efficiently designed network. The system shown in Figure 9 solves the problems inherent in attempting to service large numbers of users, the most obvious obstacles being the issues of load and performance. In this embodiment shown in Figure 9, communications servers 180 distribute and route
10 messages across a LAN, WAN and the Internet. Referring to Figure 9, in the center of the diagram is the Group Database server. Surrounding the database server are several Com Servers 180, each serving an area 192. Surrounding each Com Server 180 are squares representing user stations 188. The Communication Servers 180 are organized in node relationships with one another.

Each node is responsible for serving an Area 192. An Area 192 is defined as a Virtual
15 location serviced by a single Communications Server 180 (or "Com Server"). An Area 192 may be a single school, an office, or may consist of several actual physical locations. The defining characteristic of an Area 192 is that messages sent from one member of an Area 192 to another need not be routed outside of the servicing Com Server 180.

An Area member is analogous to the frequently used term "user." For example, a
20 "user" may be a student in the educational embodiment described above with reference to Figures 7 and 8.

The Distributed Communication System of Figure 9 shall permit the dynamic addition of Communication Servers 180 within a group with little or no administrative tasks as well as the addition of groups within an overall communications network. A Communication Server

group consists of several defined Virtual Areas 192 (preferably, consisting of no more than 250 members each), each area 192 serviced by a single Com Server 180. This system shall allow members of one Area 192, or group to easily communicate with members of another Area 192 or group without any configuration changes.

5 Generally, service of very large numbers of users has required large expensive servers and networks. As the user base increases, performance suffers and hardware must be upgraded to service the demand.

The Distributed Communication System of the present invention allows the same, relatively inexpensive machines to serve an ever-increasing user base. The technique by
10 which this will be accomplished will be through the routing of messages from one server to another when necessary.

The method essentially follows the same core pattern as IP routing and DNS lookups. If a message is for a member not belonging to the current Area 192 or group, the message shall be routed through the Distributed Communication System until its destination, or
15 someone who knows the destination and can deliver the message, is found.

The destination will be cached so subsequent messages for that member or group may be more efficiently delivered.

Referring again to Figure 9, if a message is posted by member "A" and is intended only for the members of group 1 the message shall never leave Area 1 Com Server. However,
20 if the message is intended for members of Area 1 and the members of Area 2, the Area 1 Com server forwards the message to the group database server 184. The message shall be broadcast to the members of Area 1 and tagged in the database 184 as belonging to Area 2. The message is then routed to Area 2 and broadcast to Area 2 members. With this technique any member can potentially send a message to any other member. If the Area Com server

180 does not recognize the destination, the message is forwarded up the line. Each Com server 180 does not need to know about any other server 180. Messages are routed until they delivered. If undeliverable, the original sender is notified.

New Areas 192 can be added on the fly. When a new Com server 188 is added to the network, it registers itself with the database application. Henceforth, any message destined for the new Area 192 can be routed properly without altering the other Area Servers 180.

This method and system works for global messages or for user to user messages. Furthermore, new Groups may also be dynamically added. Once added, each new Group Database Server 184 registers itself with the existing database servers 184. This distribution of load permits nearly unlimited expansion with existing software and hardware. Each server manages a finite number of members, cumulatively serving a growing community.

Users need not be informed as to the particular Com Server 180 they should connect to. Members are directed to a single URL. The selection of the server for user connection is determined by load balancing software. In this manner, the network may appear to be a global network of Servers or simply a local classroom.

The unique aspects of this architecture, using database servers as routing gateways, using techniques resembling IP routing and DNS lookup, enables this system to serve with minimum administration and configuration and with lower end, cost-effective hardware.

Local Host

Figure 10 is a diagram of a system 200 illustrating use of an entity referred to as a local host for facilitating network communication between a user machine 202 and a server 224 through a network 222 such as the Internet. A local host connection provides for increased functionality in network communication by overcoming certain limitations that exist within applets in the JAVA programming language. Applets are small applications,

typically written in the JAVA programming language. In order to ensure certain security requirements, the JAVA programming language does not permit certain functions with respect to applets. For example, applets typically cannot read to or write from a hard disk drive on a user's machine. The security requirements help to ensure that a user will not
5 unknowingly download an applet as part of a web page and have the applet adversely affect the user's system processing or stored data. In certain situations, it may be advantageous to eliminate or reduce the security restrictions with respect to applets in a particular controlled environment, and the local host provides for increasing the functions of applets in those situations.

10 System 200 includes user machine 202 having a local host or connection with server 224 through Internet 222. User machine 202 includes a web browser 204, which may be implemented with any type of web browser for Internet communication. Web browser 204 includes a HyperText Markup Language (HTML) page, referred to as a donut.html page, within a hidden HTML frame 206. Instead of frames, it may use layers such as those used
15 with dynamic HTML (DHTML) pages. Page 206 may be stored within a hidden frame or layer in memory on user machine 202. Hidden frame or layer 206 includes a donut applet 208 having functions for communicating with server 224, and applet 208 may include any application requiring communication with a server. The term "donut" is used only as a label and refers to a particular file storing user-profile information for use in transmitting content to
20 a user. User-profile information may include a wide variety of information related to a user such as, for example, one or more of the following: age of user, sex of user, marital status of user, prior activities of user, income range of user, number of people in user's household, occupation of user, industry of user, length of residence, interests of user, and other demographic and activity-based information on the user.

Use of a "donut" storing user-profile information is described in U.S. application of Craig D. Ullman, Michael R. Abato, Jeffrey M. Harrington, and Carl R. Duda, entitled "ENHANCED VIDEO PROGRAMMING SYSTEM AND METHOD UTILIZING USER-PROFILE INFORMATION," and filed on September 29, 1999.

5 Web browser 204 also includes a pi.html page within an HTML frame or layer 210 stored in memory on user machine 202. The pi.html page in frame or layer 210 is loaded from server 244. Frame or layer 210 also includes a plug-in 212 implementing a gateway module 214 for communication between applet 208 and the Internet 222. A "plug-in" is an auxiliary program that works with a software package to enhance its capability. Plug-in 212
10 implements gateway module 214 in order to provide for a local host that effectively functions as a web server. In particular, upon being loaded, pi.html page 210 instantiates plug-in 212 and gateway module 214, in the C++ programming language, for example, to open a connection 220 with applet 208.

Plug-in 212 communicates through the Internet 222 with a server 224. Server 224
15 may include a web server 226, which may be any type of web server providing for Internet or other network communication. Server 224 may also include a distributed community network (DCN) hub 228, described in U.S. application of Craig D. Ullman, Michael R. Abato, Jeffrey M. Harrington, and Carl R. Duda, entitled "ENHANCED VIDEO PROGRAMMING SYSTEM AND METHOD FOR PROVIDING A DISTRIBUTED
20 COMMUNITY NETWORK," and filed on September 15, 1999.

In operation, plug-in 212 provides a ShowDoc command 218; for example, npi: ShowDoc("http://localhost/donut.html"). The term "NPI" (or "npi") refers to the "Netscape Plugin Interface," which is an application program interface used by plug-ins in web browsers such as the Netscape Navigator program and the Microsoft Internet Explorer program. The

"ShowDoc" command is a command in the NPI and the JAVA programming language instructing a web browser to show in a frame of the web browser the content from the URL provided in the command. Therefore, the ShowDoc command is used to push content to the web browser.

5 ShowDoc command 218 instantiates an applet tag located in page 206. Upon receiving ShowDoc command 218, web browser 204 responds by sending a GET request 216 in order to establish a connection with server 224, which in turn instantiates applet 208. The GET request 216 includes a URL for a particular page, for example, "http: GET
10 http://localhost/donut.html." Plug-in 212 receives GET request 216 and uses it to open a Transmission Control Protocol/Internet Protocol (TCP/IP) socket 220 to plug-in 212, which then functions as a local host using gateway module 214 to permit open and persistent communication with server 224. A socket is a known way to provide Internet communication, and it specifies an Internet Protocol address of a station and a port number. Applet 208 subsequently communicates with server 224 through module 214, which appears
15 to applet 208 as a web server.

 Figure 11 is a flow chart of a method 250 for implementing a local host within system 200. In order to implement a local host, plug-in 212 must locally function as a web server, as the host that the JAVA code in applet 208 is allowed to access must be the same host that originally served the HTML page containing applet 208. In particular, plug-in 212
20 requires functionality to respond to only one HTTP request that it generates itself by means of ShowDoc command 218 for displaying a URL into a hidden frame or layer. That URL refers to the gateway module 214 on a port known only to plug-in 212.

 In method 250, plug-in 212 sends a URL to web browser 204 using ShowDoc command 218, such as npi: ShowDoc("http://localhost/donut.html") (step 252). Web

browser 204 loads a web page or other networked content using the URL in order to generate GET request 216 (step 254), and plug-in 212 receives GET request 216 from applet 208 in web browser 204 (step 256). The GET request includes a URL such as "http: GET http://localhost/donut.html" for indicating an address for the local host.

5 Plug-in 212 in web browser 204 uses the web page information or other networked content in order to open TCP/IP socket 220 to a local host including gateway module 214 in plug-in 210 (step 260). Therefore, gateway 214, establishing the local host, provides for socket 220 between applet 208 and server 224 (step 262). In particular, plug-in 212 acts as a proxy, forwarding requests from applet 208 to remote server 224. Plug-in 212 may
10 optionally obtain an entity referred to as a "skin," explained below, to render itself in a specific user interface for machine 202 (step 263). Applet 208 then uses the socket 220 to communicate with server 224 through plug-in 210 (step 264). As a result, applet 208 may communicate with both plug-in 212 and remote server 244. Plug-in 212 maintains socket 220 and detects whether the applet 208 disconnects the connection (step 266); if the
15 connection is disconnected, plug-in 212 removes socket 220.

A distinctive feature of plug-in 212 is its ability to use multiple skins, which are an integrated set of graphics, colors, and other multimedia content and their particular arrangement to form a specific, branded user interface. Plug-in 12 and a DCN, identified above, have the ability to distribute and receive an arbitrary object. One such object can be
20 the package of graphics and other content that comprise a skin. Before a program begins, when the user logs on to the network, the system checks to see if the particular skin is resident on the user's machine. If the skin is not resident, plug-in 212 requests the skin object, and the DCN automatically distributes the skin to plug-in 212. Once the skin is resident, the plug-in 212 renders itself using those graphics, colors, and other content.

In addition to requesting and distributing a skin when the user logs on, a programmer can also dynamically change a user's skin during the program. The logic for loading the new skin during the program is the same as the logic for loading a skin at the start of a program. This skin change can also be invoked by a playlist request or a donut event based on user-
5 profile information as described in the application identified above.

The following provides an example of use of a local host. During an event that combines automatically delivered web content through a web browser plug-in with a video stream, a question appears in the user's web browser containing an interactive question written in Macromedia Flash, a common web authoring tool. The question reads: Have you
10 bought a new car this year? Yes or No. The user clicks on "Yes." Then the JavaScript program in the web page containing the question executes a post with the format of `http://localhost?userclick=Yes`. The local host is therefore the "pipe" that connects the web browser to the plug-in. The plug-in receives this information through an open socket and acts on it to send the user another web page designed for people who just bought a new car.

15

Playlist

A playlist permits one user, referred to as an author, to push a list of URLs or network addresses to users. A playlist is a structured collection of URLs that are sent to a user's machine to either be displayed at a specified time ("pushed") or presented in a tree structure to later be pulled down when the user wants to drill down for more detail. The playlist
20 references a network address such as a URL, a description for each URL, a time value, a frameset, a frame or layer, a prefetch time (if appropriate), a pull within a push context, and potentially a variable for a dynamic URL. The playlist permits the author to effectively push various types of content to users, such as advertisements, interactive games, sports scores,

narrative content, or any type of multimedia information. The narrative content may be used, for example, to provide textual descriptions accompanying video presentations.

The author enters a URL and an associated description along with a time value. Based upon the time value, the author's machine transmits the URL, along with the description and web page or other networked content, to the user. The frame (or layer) and frameset indicates where to display the web page or other networked content on the user's machine. The prefetch time can be used to assemble a page corresponding to the URL in a hidden frame or layer. The dynamic URL permits customizing the URL based upon other information such as a user's geographic location, as explained below. In addition to web pages from the Internet, the playlist can use the URL to retrieve web pages or other content from a variety of sources such as, for example, from the user's hard disk drive or other storage medium. In addition to web pages, the playlist can be used to retrieve other content such as, for example, an audio stream, a video file, or other multimedia information.

The pull within the push context permits other ways to retrieve content using the playlist, as illustrated by the following example. During a news program, the television broadcast shows a clip of a presidential news conference. A playlist item, a web page or other networked content designed to appear in a particular frame in a particular frameset, is pushed (automatically delivered) to all the users on-line. In addition, the news organization broadcasting the conference has several other web pages that the user may be interested in as background material. This other networked content is sent as a "pull within a push" playlist item. The additional content does not automatically appear in the user's browser; rather, the user receives an indication that other networked content can be accessed by clicking their mouse on a graphic, or through other types of user input. Therefore, the pull within the push

context permits content to be pushed to a user and through that content the user can pull additional content to the user machine.

Also, instead of URLs, the playlist can include Uniform Resource Identifiers (URIs).

A URI is a compact string of characters for identifying an abstract or physical resource.

5 More specifically, URIs provide a simple and extensible means for identifying a resource, and a URI can be further classified as a locator, a name, or both. The specification of URI syntax and semantics is derived from concepts introduced by the World Wide Web global information initiative. URIs include, for example, URLs and Uniform Resource Names (URNs). A URL is a subset of a URI that identifies resources via a representation of their
10 primary access mechanism, such as their network "location," rather than identifying the resource by name or other attribute of that resource. The term URN refers to a subset of URI that is required to remain globally unique and persistent even when the resource ceases to exist or becomes unavailable.

Figure 12 is a diagram of a user interface 300 illustrating display of a playlist to an
15 author of the playlist content. In this example, the playlist content is shown in a section 302 displayed within screen 300. The content includes, for each URL, a textual description 308, a type of content 310, a URL 312, and a time value 314. Textual description 308 permits an author to provide a potentially more descriptive identifier for the content associated with a particular URL. Type of content 310 identifies for each URL the type of associated content
20 or how it is displayed, and examples include push content (PSH), a ticker display (TIC), and an advertisement (ADV). Section 302 includes a playlist menu item 304 for a user to select in order to view playlist section 302 listing the playlist. It also includes an edit item 306 for a user to select in order to create or edit the playlist content.

Upon selecting item 306, the author's machine displays user interface 320 shown in Figure 13. User interface 320 includes a section 322 for the author to enter a textual description for a particular URL. A section 324 permits the author to enter the URL. A section 326 provides a pull-down menu permitting the author to identify a particular frame or layer on the user's machine in which the content associated with the URL in section 324 will be displayed. A section 328 provides a pull-down menu permitting the author to select a frame set identifying how many frames or layers will be displayed on the user's machine. As shown, one option is a triple frame set in which three frames are displayed. Other examples a single, double, or quadruple frame set for displaying, respectively, one, two, or four frames.

A time section 330 permits the author to identify a time value for the author's machine to transmit to a user's machine the URL in section 324, description in section 322, and possibly an associated web page or other networked content. In this example, the author may enter values for hours, minutes, and seconds. The author's machine uses that entered time value as a timer, and it pushes the associated URL to the user's machine upon time-out of the entered time value. Other time parameters are possible for determining when to push the URL to a user's machine, such as specifying a particular time and day at which to push it or an amount of time after occurrence of a particular event.

In edit section 320, the author may select an add section 332 to add the entered information to the playlist and select a cancel section 334 to cancel the entered information. The author typically selects the sections by user a cursor-control device to "click on" the section or by entering a command using a keyboard or other type of input device.

Figure 14 is a diagram of a user interface 340 for illustrating display of playlist items pushed to a user. User interface 340 includes a section 342 for displaying playlist items pushed to the user. Usually, only the descriptions are displayed to the user, while the

associated URLs and web pages or other networked content are also stored on the user's a machine and linked with the descriptions. User interface 340 also includes frames or layers in which to display content associated with the URLs pushed to the user, and these include, for example, a frame 356 for displaying video content, a frame 350 displaying an advertisement, a frame 352 for displaying a trivia game, and a frame 354 for displaying a ticker display of sports scores.

Upon selecting a description among the playlist items in section 342, the user may retrieve and view associated content. The description may thus operate as a hypertext link. For example, by selecting description 344, the ticker display in section 354 is displayed. By selecting description 346, the trivia game in frame 352 is displayed. By selecting description 348, the advertisement in frame 350 is displayed. The user may select other descriptions among the playlist items in section 342 in order to view the associated content or web pages or other networked content. The frame or layer in which the content is displayed depends upon the frame or layer information identified by the author in section 326 of edit section 320.

Figure 15 is a diagram of a data structure 360 for playlist entities. The playlist entity provides a name and identifier to the collection of URLs. Data structure 360 includes multiple entities or other data structure elements for storing the playlist entities and associated data. In this example, these entities include a Playlist entity 362, a PlaylistItem entity 364, a frame or layer entity 366, a ResFolder entity 368, and a ResItem entity 370.

The actual URL data is stored in a ResItem field 371 of resData entity 370. ResFolder entity 368 is used by the author of the playlist to organize data in ResItem entity 370 into a folder hierarchy for organizational convenience and typically has no effect on the

end user experience. A defFrameSetID field 372, a defFrame field 373, and a description field 374 are similarly conveniences for the author.

PlaylistItem entity 364, also referred to as "item," represents a specified ResItem in entity 370. It is identified by a resItemID field 376 in a playlist identified by playlistID field 376. The item is to be shown after a time specified by a timeOffset field 377. In particular, the item is pushed to the user's machine at that time unless a pull only feature is set as identified in a pullOnly field 378, in which case the item is a pull within a push context. The item is to be shown in the frame or layer specified by a frame field 379 and a frameSetID field 380. A description field 381 specifies the description seen by the user in the displayed playlist. Default values for frame field 379, frameSetID field 380, and description field 381 are derived from the corresponding item in ResItem entity 370. A prefetch field 382 indicates the pre-loading of the URL in a staging area. A staging area for prefetch involves the assembly of a page in a hidden frame for subsequent display of a completely assembled web page, as explained in U.S. application of Jeffrey M. Harrington, entitled "ENHANCED VIDEO PROGRAMMING SYSTEM AND METHOD UTILIZING A WEB PAGE STAGING AREA," and filed on September 15, 1999.

A parentID field 383 of PlaylistItem entity 364 specifies a parent item in the hierarchy of items. In a flat playlist, parentID is null. When in a hierarchy, timeOffset field 377 is relative to a time offset for a parent item. The relationship is recursive, making it easy to push a playlist at any time and to reuse URL resources and their relationships in the authoring tool.

Frame entity 366 specifies a specific frame or layer within a frameset into which an item is to be pushed or pulled. It is referred to by both ResItem entity 370 and PlaylistItem entity 364. These entities may exist in multiple databases or even by multiple vendors and

are manipulated by the authoring tools such as those available in the C++, JAVA, and Tango programming languages. They can be exchanged and manually edited in Extensible Markup Language (XML) and transmitted over a distributed community network. An example of a distributed community network is explained in U.S. application of Craig D. Ullman, Michael R. Abato, Jeffrey M. Harrington, and Carl R. Duda, entitled "ENHANCED VIDEO PROGRAMMING SYSTEM AND METHOD FOR PROVIDING A DISTRIBUTED COMMUNITY NETWORK," and filed on September 15, 1999.

Figure 16 is a flow chart of a method 400 for implementing a playlist. Method 400 may be implemented using software modules for execution by a corresponding machine. In method 400, the system receives playlist information from the author in edit section 320 (step 402). This information may include a URL, a description, a frame or layer identification, and a time value. The system uses the playlist information to generate and display a playlist as shown in section 302 (step 404). The system continually monitors the playlist to determine if it contains an item (step 406). If it contains an item, the system determines if prefetch was invoked (step 408) and, if so, it pushes the playlist item with a web page or other networked content to the user's machine along with a prefetch time (step 410). The user's machine uses a web page staging area to display the playlist item as described in the copending application identified above (step 412). If prefetch was not invoked, the system determines if the offset time as entered by the author has expired (step 414). Once the offset time expires, the system pushes the playlist item with a web page or other networked content to the user's machine and displays the item as shown in section 342 (step 416). Particular content is also pushed to the user's machine based upon the user's selection of playlist items (step 413).

The system determines if the author has closed the playlist (step 418). If the playlist remains open, the system determines if the author enters more playlist information in edit

section 320. If more playlist information is to be entered, the system returns to step 402 to receive the playlist information and then generate and display a new playlist at step 404. If the user does not enter more playlist information, the system returns to step 406 to process any additional items in the playlist.

5

Dynamic URLs

A dynamic URLs feature permits a system to dynamically configure a URL, URI, or other content identifier based upon resolution of a variable and therefore customize URL content for particular users. The dynamic URL is important for localizing content and for transmitting any of the types of content described with respect to the playlist. For example, a national television broadcast might play a particular automobile commercial, but the advertiser would want to send via the Internet a web page referencing every viewer's local dealer. User Bob lives in Los Angeles and there is a specific automobile dealer based a few miles away from Bob on Ventura Blvd. The playlist author would have a playlist entry for the automobile ad that would include a dynamic URL. The server software may determine which one many URLs that references all particular dealers in America should be sent to Bob, or Bob's user profile (donut) in his client may parse the dynamic URL, determine the specific web address of the Ventura automobile dealer web page, and push that network address into Bob's browser.

The dynamic URLs may be stored and distributed in a playlist as described above and executed as part of steps 410 and 416. A dynamic URL may be identified by the presence of a variable with particular characters. The dynamic URL may contain the variable in brackets "{" and "}" as follows, for example, PSH://http://content.qa.actv.com/{variable}.

Figure 17 is a flow chart of a method 430 for processing dynamic URLs, URIs, or other network addresses. Method 430 may be implemented using software modules for

execution by a corresponding machine. In method 430, the system retrieves a playlist item including a URL (step 431) and determines if the retrieved URL is a dynamic URL (step 432). It may determine if the URL is dynamic by parsing the URL to detect the presence of a variable in brackets or other distinguishing characters. If it is not a dynamic URL, the system
5 returns the playlist item with no processing to the URL (step 446).

If it is a dynamic URL, the system resolves the variable in the URL (step 434). The system determines if the variable references or invokes a particular process (step 436). If a process is not involved, the system obtains a definition for the variable (step 444). If the variable does invoke a process, the system retrieves and executes the process in order to
10 generate a definition for the variable (step 438). The system may resolve the variable based upon an identification of an intended recipient of the URL in order to customize content for the user. For example, it may obtain user-profile information, as described in the copending application identified above, and select a variable definition based upon the user-profile information, or it may use a geographic location of the user to resolve the variable. The
15 user's location may be determined, for example, from the user-profile information. Using the variable definition, the system assembles a completed URL (step 440) and returns the playlist item with the assembled URL in steps 410 and 416 of playlist method 400 (step 442)

Using the foregoing embodiments, methods and processes, the system of the present invention creates a synergistic experience combining the vast resources of the Internet with
20 the presentation capabilities of television.

CLAIMS

1. A method for providing a machine with network communication with a server,
comprising:
 - receiving a request for a network connection;
 - 5 generating a reference to a local connection in response to the request;
 - detecting communication at the local connection; and
 - establishing a connection with the local connection in response to the detecting and
for facilitating network communication with the machine.
- 10 2. The method of claim 1 wherein the establishing step comprises providing a local web
server function at the local connection.
3. The method of claim 1 wherein the receiving step comprises receiving networked
content.
- 15 4. The method of claim 1 wherein the establishing step comprises providing a socket for
the communication.
5. The method of claim 1 wherein the receiving step comprises receiving a request for a
20 web page from a web browser.
6. The method of claim 1, further comprising downloading networked content from a
network for use in establishing the connection.

7. The method of claim 1 wherein the receiving step comprises receiving the request from an applet.
8. The method of claim 1 wherein the generating step comprises providing an address of the local connection.
9. The method of claim 1 wherein the detecting comprises receiving information for use in opening a socket with the local connection.
10. The method of claim 1, further comprising detecting a disconnection from the local connection.
11. The method of claim 1, further comprising obtaining particular content for use in rendering a specific user interface for the network communication.
12. An apparatus for providing a machine with network communication with a server, comprising:
- a receive module for receiving a request for a network connection;
 - a generate module for generating a reference to a local connection in response to the request;
 - a detect module for detecting communication at the local connection; and
 - a connection module for establishing a connection with the local connection in response to the detecting and for facilitating network communication with the machine.

13. The apparatus of claim 12 wherein the connection module comprises a module for providing a local web server function at the local connection.
14. The apparatus of claim 12 wherein the receive module comprises a module for
5 receiving networked content.
15. The apparatus of claim 12 wherein the connection module comprises a module for providing a socket for the communication.
- 10 16. The apparatus of claim 12 wherein the receive module comprises a module for receiving a request for a web page from a web browser.
17. The apparatus of claim 12, further comprising a module for downloading networked content from a network for use in establishing the connection.
15
18. The apparatus of claim 12 wherein the receive module comprises a module for receiving the request from an applet.
19. The apparatus of claim 12 wherein the generate module comprises a module for
20 providing an address of the local connection.
20. The apparatus of claim 12 wherein the detect module comprises a module for receiving information for use in opening a socket with the local connection.

21. The apparatus of claim 12, further comprising a module for detecting a disconnection from the local connection.
22. The apparatus of claim 12, further comprising a module for obtaining particular
5 content for use in rendering a specific user interface for the network communication.
23. A method for distributing network addresses to user machines for use in obtaining content associated with the addresses, comprising:
receiving a plurality of network addresses identifying network locations of particular
10 content;
receiving an associated description for each of the network addresses;
receiving a time value of a time parameter associated with each of the network
addresses; and
transmitting each of the network addresses along with the associated descriptions to
15 the user machines based upon each of the corresponding time values.
24. The method of claim 23 wherein the receiving the network addresses step comprises receiving a plurality of uniform resource locators.
- 20 25. The method of claim 23 wherein the receiving the network addresses step comprises receiving a plurality of uniform resource identifiers.
26. The method of claim 23 wherein the receiving the description step comprises receiving a textual description for each of the network addresses.

27. The method of claim 23 wherein the receiving the time value step comprises receiving a time-out value.
- 5 28. The method of claim 23, further comprising receiving for each of the network addresses an indication of a frame or layer in which to display the corresponding descriptions on the user machines.
29. The method of claim 23, further comprising receiving for each of the network
10 addresses an indication of a type of a content identified by the network address.
30. The method of claim 23 wherein the transmitting step comprises transmitting to the user machines networked content corresponding to each of the network addresses.
- 15 31. The method of claim 23, further comprising permitting a user to specify the network addresses, the associated descriptions, and the time values.
32. The method of claim 31 wherein the permitting step comprises displaying a user interface for receiving from the user the network addresses, the associated descriptions, and
20 the time values.
33. The method of claim 23 wherein:
the receiving the associated description step comprises receiving an indication of the particular content; and

the transmitting step comprises transmitting the indication of the particular content to the user machines for permitting users to select the indication in order to retrieve the particular content.

5 34. The method of claim 23 wherein:

the receiving the associated description step comprises receiving a hypertext link; and
the transmitting step comprises transmitting the hypertext link to the user machines.

10 35. The method of claim 23 wherein the receiving the network addresses step
comprises receiving an identification of advertising content.

36. The method of claim 23 wherein the receiving the network addresses step comprises receiving an identification of sports content, narrative content, or interactive game content.

15 37. An apparatus for distributing network addresses to user machines for use in obtaining content associated with the addresses, comprising:

a module for receiving a plurality of network addresses identifying network locations of particular content;

a module for receiving an associated description for each of the network addresses;

20 a module for receiving a time value of a time parameter associated with each of the network addresses; and

a transmission module for transmitting each of the network addresses along with the associated descriptions to the user machines based upon each of the corresponding time values.

38. The apparatus of claim 37 wherein the module for receiving the network addresses comprises a module for receiving a plurality of uniform resource locators.

5 39. The apparatus of claim 37 wherein the module for receiving the network addresses step comprises a module for receiving a plurality of uniform resource identifiers.

40. The apparatus of claim 37 wherein the module for receiving the description comprises a module for receiving a textual description for each of the network addresses.

10

41. The apparatus of claim 37 wherein the module for receiving the time value comprises a module for receiving a time-out value.

42. The apparatus of claim 37, further comprising a module for receiving for each of the
15 network addresses an indication of a frame or layer in which to display the corresponding descriptions on the user machines.

43. The apparatus of claim 37, further comprising a module for receiving for each of the network addresses an indication of a type of a content identified by the network address.

20

44. The apparatus of claim 37 wherein the transmission module comprises a module for transmitting to the user machines networked content corresponding to each of the network addresses.

45. The apparatus of claim 37, further comprising a module for permitting a user to specify the network addresses, the associated descriptions, and the time values.

46. The apparatus of claim 45 wherein the module for permitting comprises a module for displaying a user interface for receiving from the user the network addresses, the associated descriptions, and the time values.

47. The apparatus of claim 37 wherein:
the module for receiving the associated description comprises a module for receiving an indication of the particular content; and

the module for transmitting comprises a module for transmitting the indication of the particular content to the user machines for permitting users to select the indication in order to retrieve the particular content.

48. The apparatus of claim 37 wherein:
the module for receiving the associated description comprises a module for receiving a hypertext link; and

the module for transmitting comprises a module for transmitting the hypertext link to the user machines.

20

49. The apparatus of claim 37 wherein the module for receiving the network addresses comprises a module for receiving an identification of advertising content.

50. The apparatus of claim 37 wherein the module for receiving the network addresses comprises a module for receiving an identification of sports content, narrative content, or interactive game content.

5 51. A method for distributing dynamic network addresses to user machines for use in obtaining content associated with the addresses, comprising:

receiving a network address containing a variable, the network address identifying varying network locations of particular content based upon the variable;

receiving an associated description for the network address;

10 receiving a time value of a time parameter associated with the network address;

resolving the variable in the network address based upon information related to an intended recipient of the network address; and

transmitting the network address along with the associated description to a user machine corresponding with the intended recipient based upon the corresponding time value.

15

52. The method of claim 51 wherein the resolving step comprises executing a process associated with the variable.

53. The method of claim 51 wherein the resolving step comprises obtaining information
20 based upon the variable.

54. The method of claim 53 wherein the resolving step comprises assembling the network address using the information.

55. The method of claim 51 wherein the receiving the network address step comprises receiving a uniform resource locator.
56. The method of claim 51 wherein the receiving the network address step comprises
5 receiving a uniform resource identifier.
57. The method of claim 51 wherein the receiving the description step comprises receiving a textual description for the network address.
- 10 58. The method of claim 51 wherein the receiving the time value step comprises receiving a time-out value.
59. The method of claim 51, further comprising receiving for the network address an indication of a frame or layer in which to display the corresponding description on the user
15 machine.
60. The method of claim 51, further comprising receiving for the network address an indication of a type of a content identified by the network address.
- 20 61. The method of claim 51 wherein the transmitting step comprises transmitting to the user machine networked content corresponding to the network address.
62. The method of claim 51 wherein the receiving the network address step comprises receiving an identification of advertising content.

63. The method of claim 51 wherein the receiving the network address step comprises receiving an identification of sports content, narrative content, or interactive game content.
- 5 64. The method of claim 51 wherein the resolving step comprises resolving the variable based upon user-profile information related to a user.
65. The method of claim 64 wherein the resolving step comprises resolving the variable based upon demographic information related to the user.
- 10 66. The method of claim 64 wherein the resolving step comprises resolving the variable based upon activity-based information related to the user.
67. The method of claim 64 wherein the resolving step comprises resolving the variable
15 based upon at least one of the following: an age of the user, a sex of the user, a marital status of the user, prior activities of the user, an income range of the user, a number of people in the user's household, an occupation of the user, an industry of the user, a length of residence of the user, or interests of user.
- 20 68. The method of claim 51 wherein the resolving step comprises resolving the variable based upon identification of a geographic location of the user.
69. An apparatus for distributing dynamic network addresses to user machines for use in obtaining content associated with the addresses, comprising:

a module for receiving a network address containing a variable, the network address identifying varying network locations of particular content based upon the variable;

a module for receiving an associated description for the network address;

a module for receiving a time value of a time parameter associated with the network
5 address;

a resolution module for resolving the variable in the network address based upon information related to an intended recipient of the network address; and

a transmission module for transmitting the network address along with the associated description to a user machine corresponding with the intended recipient based upon the
10 corresponding time value.

70. The apparatus of claim 69 wherein the resolution module comprises a module for executing a process associated with the variable.

15 71. The apparatus of claim 69 wherein the resolution module comprises a module for obtaining information based upon the variable.

72. The apparatus of claim 71 wherein the resolution module comprises a module for assembling the network address using the information.

20

73. The apparatus of claim 69 wherein the module for receiving the network address comprises a module for receiving a uniform resource locator.

74. The apparatus of claim 69 wherein the module for receiving the network address step comprises a module for receiving a uniform resource identifier.
75. The apparatus of claim 69 wherein the module for receiving the description comprises
5 a module for receiving a textual description for the network address.
76. The apparatus of claim 69 wherein the module for receiving the time value comprises a module for receiving a time-out value.
- 10 77. The apparatus of claim 69, further comprising a module for receiving for the network address an indication of a frame or layer in which to display the corresponding description on the user machine.
78. The apparatus of claim 69, further comprising a module for receiving for the network
15 address an indication of a type of a content identified by the network address.
79. The apparatus of claim 69 wherein the transmission module comprises a module for transmitting to the user machine networked content corresponding to the network address.
- 20 80. The apparatus of claim 69 wherein the module for receiving the network address comprises a module for receiving an identification of advertising content.

81. The apparatus of claim 69 wherein the module for receiving the network address comprises a module for receiving an identification of sports content, narrative content, or interactive game content.
- 5 82. The apparatus of claim 69 wherein the resolution module comprises a module for resolving the variable based upon user-profile information related to a user.
83. The apparatus of claim 82 wherein the resolution module comprises a module for resolving the variable based upon demographic information related to the user.
- 10 84. The apparatus of claim 82 wherein the resolution module comprises a module for resolving the variable based upon activity-based information related to the user.
85. The apparatus of claim 82 wherein the resolution module comprises a module for
15 resolving the variable based upon at least one of the following: an age of the user, a sex of the user, a marital status of the user, prior activities of the user, an income range of the user, a number of people in the user's household, an occupation of the user, an industry of the user, a length of residence of the user, or interests of user.
- 20 86. The apparatus of claim 69 wherein the resolution module comprises a module for resolving the variable based upon identification of a geographic location of the user.
87. A method of receiving information over a network, the information related to a program, comprising:

activating a computer program associated with a user machine, the computer program operating as local server to provide communication between the user machine and the network; and

receiving the information at the user machine from the network via the computer
5 program.

88. The method of claim 87 further comprising the step of reading data from a memory device coupled to the user machine.

10 89. The method of claim 87 further comprising the step of writing data from a memory device coupled to the user machine.

90. The method of claim 87 wherein the network is the Internet.

15 91. The method of claim 90 wherein the information related to the program further comprises a uniform resource locator.

92. The method of claim 87 wherein the program is provided from the group consisting of: broadcast television, VHS tape, Beta tape, CD-ROM, DVD, Internet and a video server.

20

93. The method of claim 87, further comprising the step of transmitting a response from the user machine via the computer program to the network.

94. The method of claim 87 wherein the computer program is a plug-in in a web browser.

95. The method of claim 94 wherein the plug-in instantiates a gateway module for communication with the network.

5

96. The method of claim 95 wherein for communication purposes the plug-in appears to the user machine and the network to be a web server.

97. A method of providing information related to a program over a network, comprising:
10 selecting information related to the program; and
transmitting the information from the network to a user machine, the user machine associated with a computer program, the computer program operating as local server to provide communication between the user machine and the network.

15 98. The method of claim 97 further comprising the step of reading data from a memory device coupled to the user machine.

99. The method of claim 97 further comprising the step of writing data from a memory device coupled to the user machine.

20

100. The method of claim 97 wherein the network is the Internet.

101. The method of claim 100 wherein the information related to a program further comprises a uniform resource locator.

102. The method of claim 97 wherein the program is provided from the group consisting of: broadcast television, VHS tape, Beta tape, CD-ROM, DVD, Internet and a video server.
- 5 103. The method of claim 97, further comprising the step of transmitting a response from the user machine via the computer program to the network.
104. The method of claim 97 wherein the computer program is a plug-in in a web browser.
- 10 105. The method of claim 104 wherein the plug-in instantiates a gateway module for communication with the network.
106. The method of claim 105 wherein for communication purposes the plug-in appears to the user machine and the network to be a web server.
- 15 107. A method of receiving information over a network, the information related to a television program, comprising:
- activating a computer program associated with a user machine, the computer program operating as local server to provide communication between the user machine and the
- 20 network; and
- receiving the information at the user machine from the network via the computer program.

108. The method of claim 107 further comprising the step of reading data from a memory device coupled to the user machine.
109. The method of claim 107 further comprising the step of writing data from a memory
5 device coupled to the user machine.
110. The method of claim 107 wherein the network is the Internet.
111. The method of claim 110 wherein the information related to the television program
10 further comprises a uniform resource locator.
112. The method of claim 107 wherein the television program is provided from the group consisting of: broadcast television, VHS tape, Beta tape, CD-ROM, DVD, Internet and a video server.
15
113. The method of claim 107, further comprising the step of transmitting a response from the user machine via the computer program to the network.
114. The method of claim 107 wherein the computer program is a plug-in in a web
20 browser.
115. The method of claim 114 wherein the plug-in instantiates a gateway module for communication with the network.

116. The method of claim 115 wherein for communication purposes the plug-in appears to the user machine and the network to be a web server.

117. A method of providing information related to a television program over a network,
5 comprising:

selecting information related to the television program; and

transmitting the information from the network to a user machine, the user machine associated with a computer program, the computer program operating as local server to provide communication between the user machine and the network.

10

118. The method of claim 117 further comprising the step of reading data from a memory device coupled to the user machine.

119. The method of claim 117 further comprising the step of writing data from a memory
15 device coupled to the user machine.

120. The method of claim 117 wherein the network is the Internet.

121. The method of claim 120 wherein the information related to the television program
20 further comprises a uniform resource locator.

122. The method of claim 117 wherein the television program is provided from the group consisting of: broadcast television, VHS tape, Beta tape, CD-ROM, DVD, Internet and a video server.

123. The method of claim 117, further comprising the step of transmitting a response from the user machine via the computer program to the network.

5 124. The method of claim 117 wherein the computer program is a plug-in in a web browser.

125. The method of claim 124 wherein the plug-in instantiates a gateway module for communication with the network.

10

126. The method of claim 125 wherein for communication purposes the plug-in appears to the user machine and the network to be a web server.

127. A method of receiving information related to a television program over the Internet,
15 comprising:

activating a computer program associated with a user machine, the computer program operating as local server to provide communication between the user machine and the network; and

receiving the information at the user machine from the network via the computer
20 program, the information including a uniform resource locator from a playlist containing at least one uniform resource locator related to the television program.

128. The method of claim 127 further comprising the step of reading data from a memory device coupled to the user machine.

129. The method of claim 127 further comprising the step of writing data from a memory device coupled to the user machine.
- 5 130. The method of claim 127 wherein the uniform resource locator is directed to a web site providing addition information related to the content of the television program.
131. The method of claim 127 wherein the uniform resource locator is directed to a web site providing addition information related to advertising associated with the television
10 program.
132. The method of claim 127 wherein the television program is provided from the group consisting of: broadcast television, VHS tape, Beta tape, CD-ROM, DVD, Internet and a video server.
15
133. The method of claim 127, further comprising the step of transmitting a response from the user machine via the computer program to the network.
134. The method of claim 127 wherein the computer program is a plug-in in a web
20 browser.
135. The method of claim 134 wherein the plug-in instantiates a gateway module for communication with the network.

136. The method of claim 135 wherein for communication purposes the plug-in appears to the user machine and the network to be a web server.

137. A method of providing information related to a television program over a network,
5 comprising:

selecting information including a uniform resource locator from a playlist containing at least one uniform resource locator related to the television program; and

transmitting the information from the network to a user machine, the user machine associated with a computer program, the computer program operating as local server to
10 provide communication between the user machine and the network.

138. The method of claim 137 further comprising the step of reading data from a memory device coupled to the user machine.

15 139. The method of claim 137 further comprising the step of writing data from a memory device coupled to the user machine.

140. The method of claim 137 wherein the uniform resource locator is directed to a web site providing addition information related to the content of the television program.
20

141. The method of claim 137 wherein the uniform resource locator is directed to a web site providing addition information related to advertising associated with the television program.

142. The method of claim 137 wherein the television program is provided from the group consisting of: broadcast television, VHS tape, Beta tape, CD-ROM, DVD, Internet and a video server.
- 5 143. The method of claim 51, further comprising the step of transmitting a response from the user machine via the computer program to the network.
144. The method of claim 137 wherein the computer program is a plug-in in a web browser.
- 10 145. The method of claim 144 wherein the plug-in instantiates a gateway module for communication with the network.
146. The method of claim 145 wherein for communication purposes the plug-in appears to
15 the user machine and the network to be a web server.
147. A communications apparatus for providing network communications, comprising:
instantiating a gateway module within the communications apparatus; and
opening a connection to a network with the gateway module; and
20 emulating a web server for communications with the network.
148. The communications apparatus of claim 147, wherein the gateway module utilizes information transmitted over a network and received by a browser, the browser being supported by the communications apparatus.

149. The communications apparatus of claim 148, wherein the gateway module is instantiated in response to a command from an applet.

5 150. A method for connecting to a network server, comprising:
loading an html page on a user machine with a web browser in communication with
the network server;
instantiating a plug-in module with the html page;
instantiating a gateway module with the plug-in module; and
10 opening a TCP/IP socket connection to the network server in response to a request
from an applet; and
emulating a web server for communications a web server in the user machine.

151. A computer readable medium containing instructions for controlling a computer
15 system in a user machine to implement a local host for communicating between the user
machine and a network server, by:
instantiating a gateway module within the user machine; and
opening a connection to the network server with the gateway module; and
emulating a web server for communications with the network server.

20 152. A computer readable medium containing instructions for controlling a computer
system in a user machine to implement a local host for communicating between the user
machine and a network server, by:
loading an html page on a user machine with a web browser in communication with
the network server;

instantiating a plug-in module with the html page;
instantiating a gateway module with the plug-in module; and
opening a TCP/IP socket connection to the network server in response to a request
from an applet.

5

153. An apparatus capable of receiving information over a network, the information related
to a program, comprising:

a user machine; and

a computer program associated with the user machine, the computer program
operating as local server to receive the information from the network and provide the
information to the user machine.

10

154. An apparatus capable of providing information related to a program over a network,
comprising:

15

an information selector, the information selector containing and transmitting
information related to the program to a computer program associated with a user machine, the
computer program operating as local server to receive the information from the network and
provide the information to the user machine.

20

155. An apparatus capable of receiving information over a network, the information related
to a television program, comprising:

a user machine; and

a computer program associated with the user machine, the computer program

operating as local server to receive the information from the network and provide the information to the user machine.

156. An apparatus capable of providing information related to a television program over a
5 network, comprising:

an information selector, the information selector containing and transmitting information related to the program to a computer program associated with a user machine, the computer program operating as local server to receive the information from the network and provide the information to the user machine.

10

157. An apparatus for receiving information over a network, the information related to a program, comprising:

means for activating a computer program associated with a user machine, the computer program operating as local server to provide communication between the user
15 machine and the network; and

means for receiving the information at the user machine from the network via the computer program.

158. An apparatus for providing information related to a program over a network,
20 comprising:

means for selecting information related to the program; and

means for transmitting the information from the network to a user machine, the user machine associated with a computer program, the computer program operating as local server to provide communication between the user machine and the network.

159. An apparatus for receiving information over a network, the information related to a television program, comprising:

means for activating a computer program associated with a user machine, the
5 computer program operating as local server to provide communication between the user machine and the network; and

means for receiving the information at the user machine from the network via the computer program.

10 160. An apparatus for providing information related to a television program over a network, comprising:

means for selecting information related to the television program; and

means for transmitting the information from the network to a user machine, the user machine associated with a computer program, the computer program operating as local server
15 to provide communication between the user machine and the network.

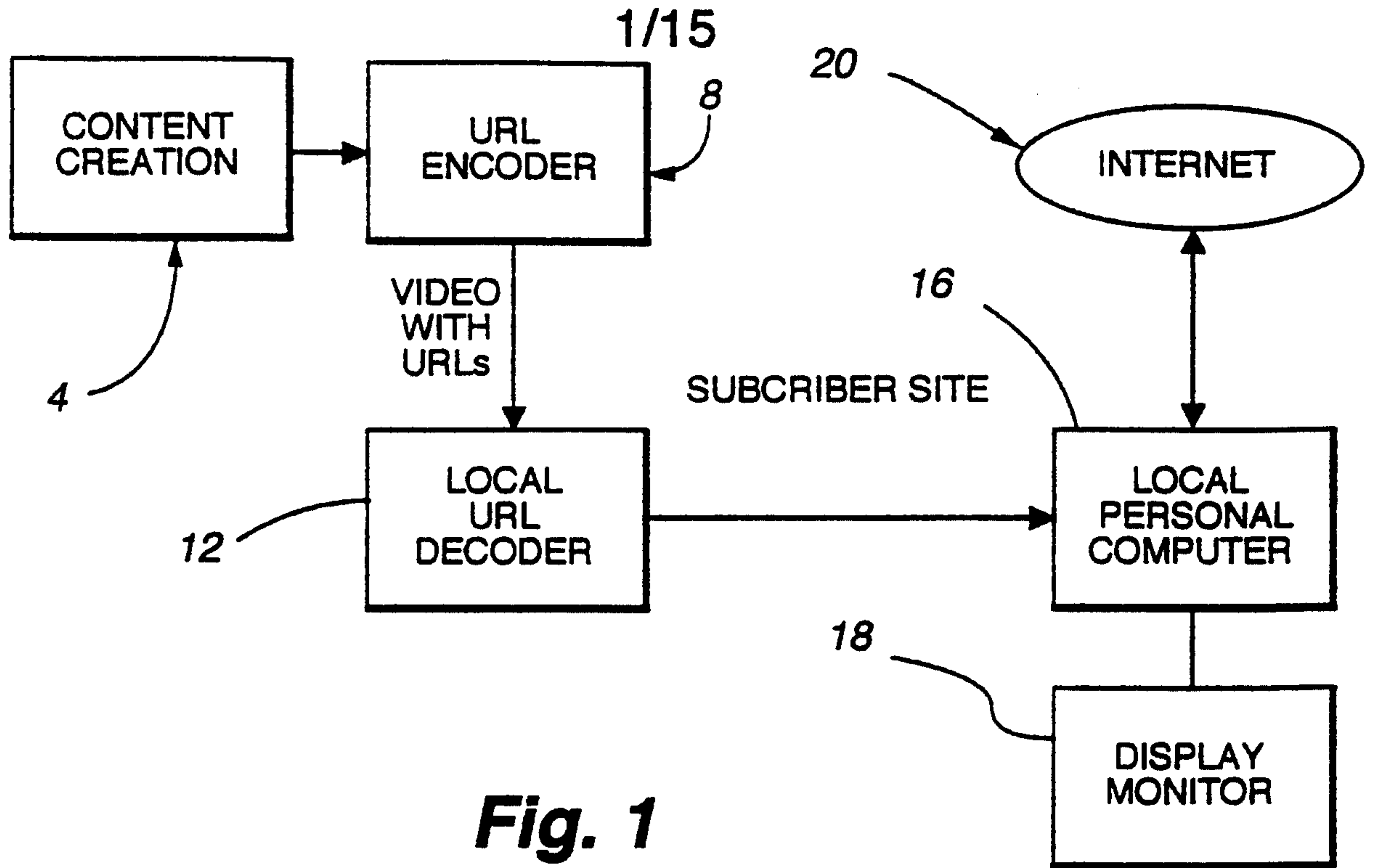
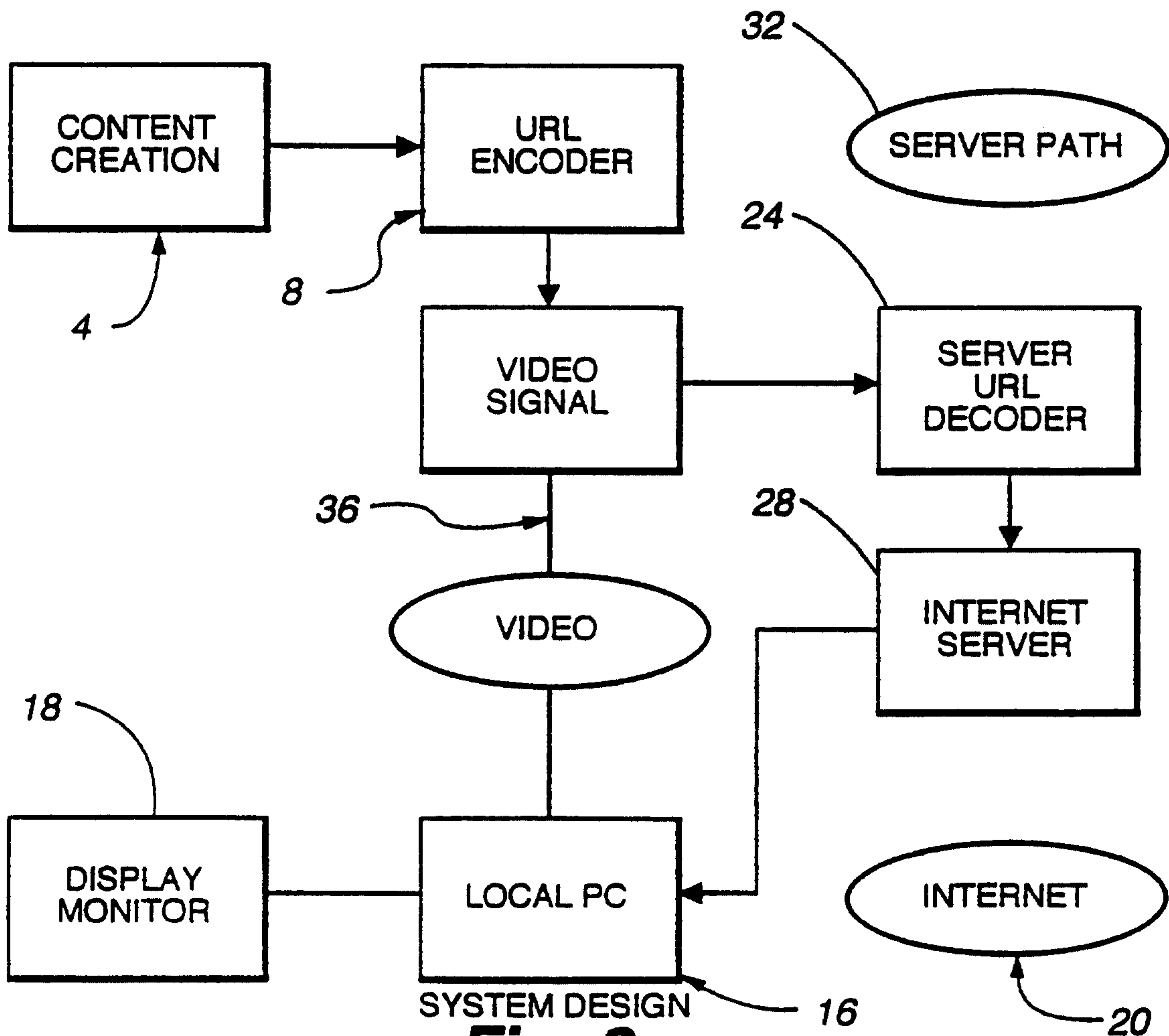
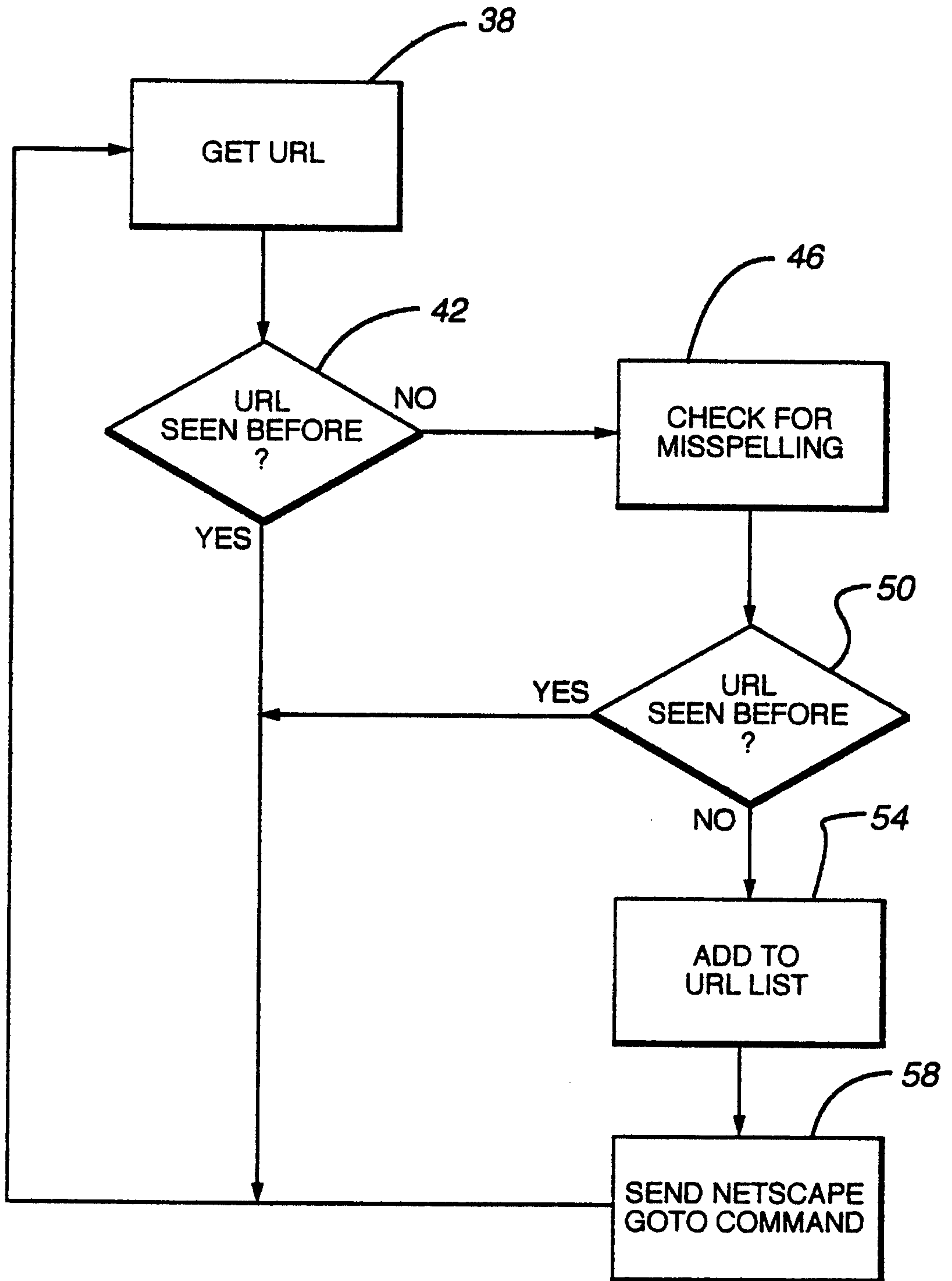

Fig. 1



SYSTEM DESIGN
Fig. 2



SOFTWARE DESIGN

Fig. 3

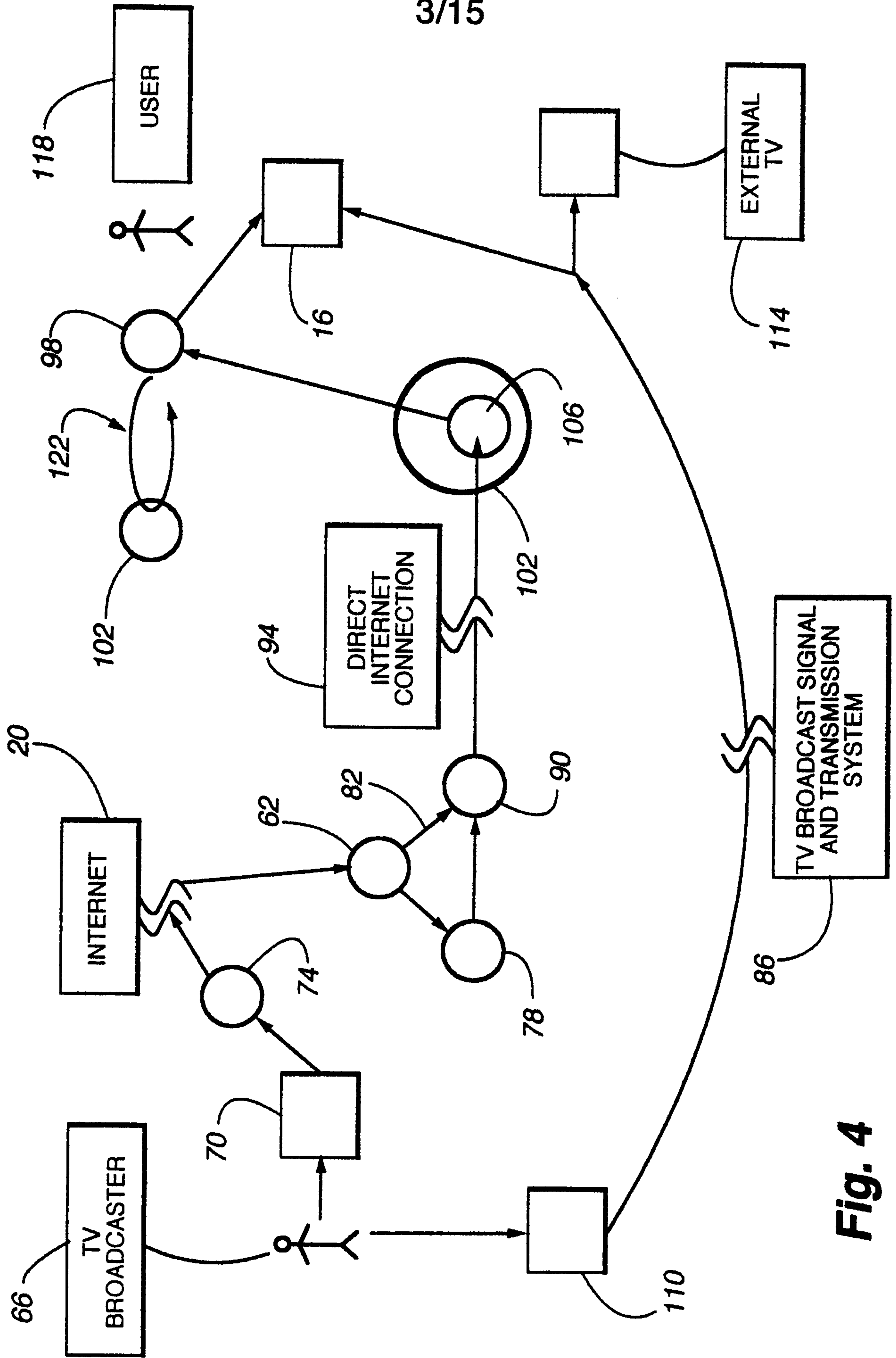

Fig. 4

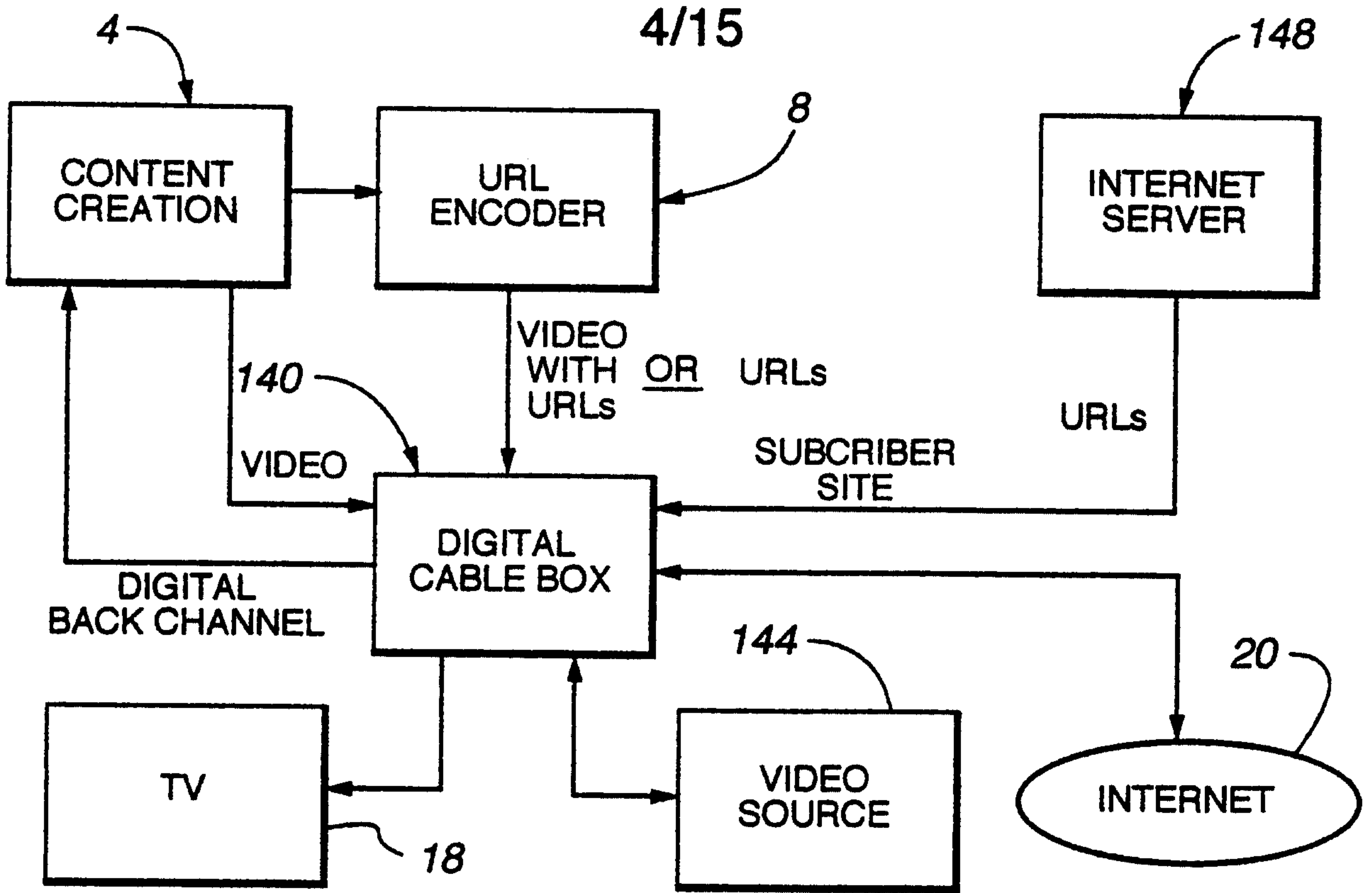

Fig. 5

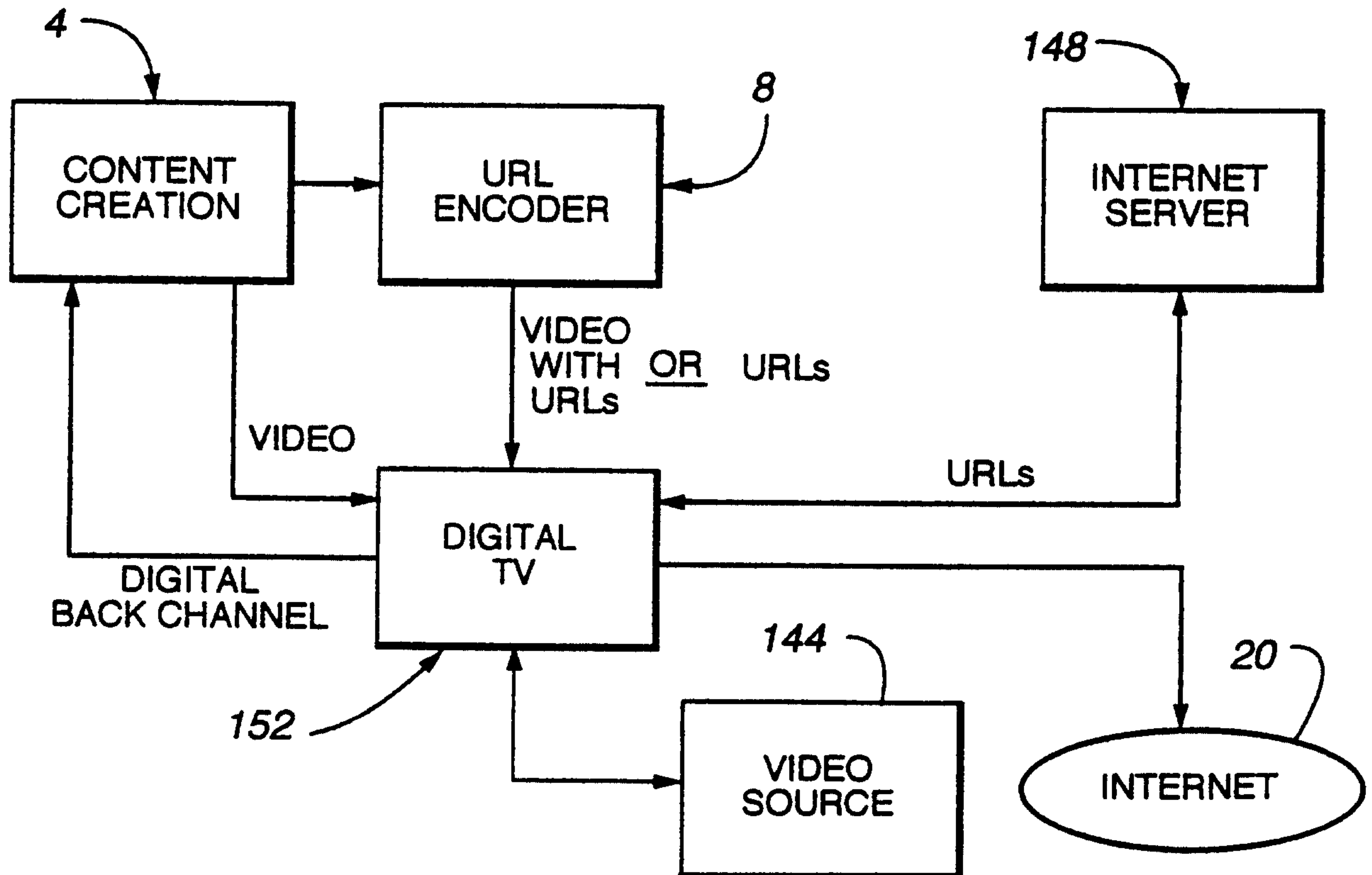

Fig. 6

156

160

Netscape-[eSchool Instructor]

Playlist
Live
Student

Scratch

Open
▼

Help
Question
Edit

School

Description

Live From The Hubble Telescope
 The Planets At A Glance
 Moons And Planets
 The Motion Of A Satellite
 Some Background Information Of Pluto
 A Visible Image On Pluto
 The Lowell Observatory
 An Article By Clyde Tombaugh
 The Solar System In Motion
 Is pluto A Planet ?
 Ask The Astronomer

Web Page Address or Question	Hour	Min
http:// eschool.actv.com/hubble/main.html	00:00:01	
http://dosxx.colorado.edu/pluto/planets.jpg	00:00:28	
http://eschool.actv.com/hubble/main2.html	00:01:08	
http://observ.ivv.nasa.gov/nasa/education/reference/orbits/orb..	00:01:46	
http://pds.jpl.nasa.gov/planets/welcome/pluto.html	00:02:46	
http://www.lowell.edu/users/bute/pluto/ana03.html	00:03:41	
http://www.lowell.edu/	00:04:26	
http://wwwjpl.nasa.gov/pluto/9thplant.html	00:04:51	
http://www.humnet.ucla.edu/humnet/french/faculty/gans/java/sola..	00:05:31	
http://dosxx.colorado.edu/plutohome.html	00:06:48	
http://www2.ari.net/home/odenwald/qadir/qanda.html	00:07:22	

Notes
Stop
Pause
Play
PlayOne
Preview

□
▶
▶▶

welcome to

brought to you by

Actv

<<Click here for help >>

Fig. 7



6/15

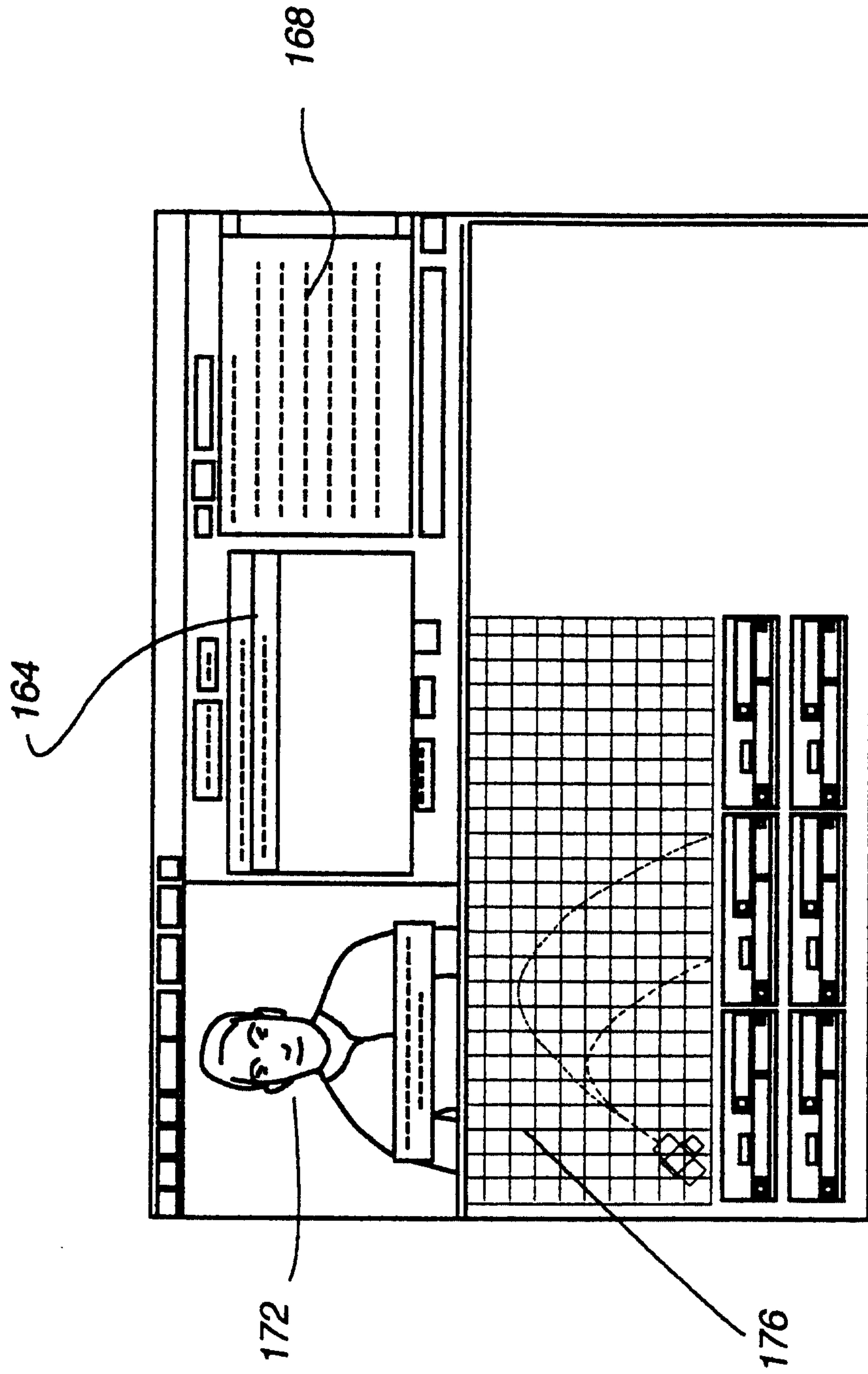
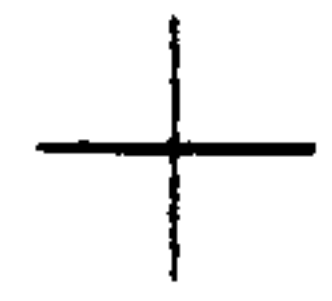

Fig. 8



7/15

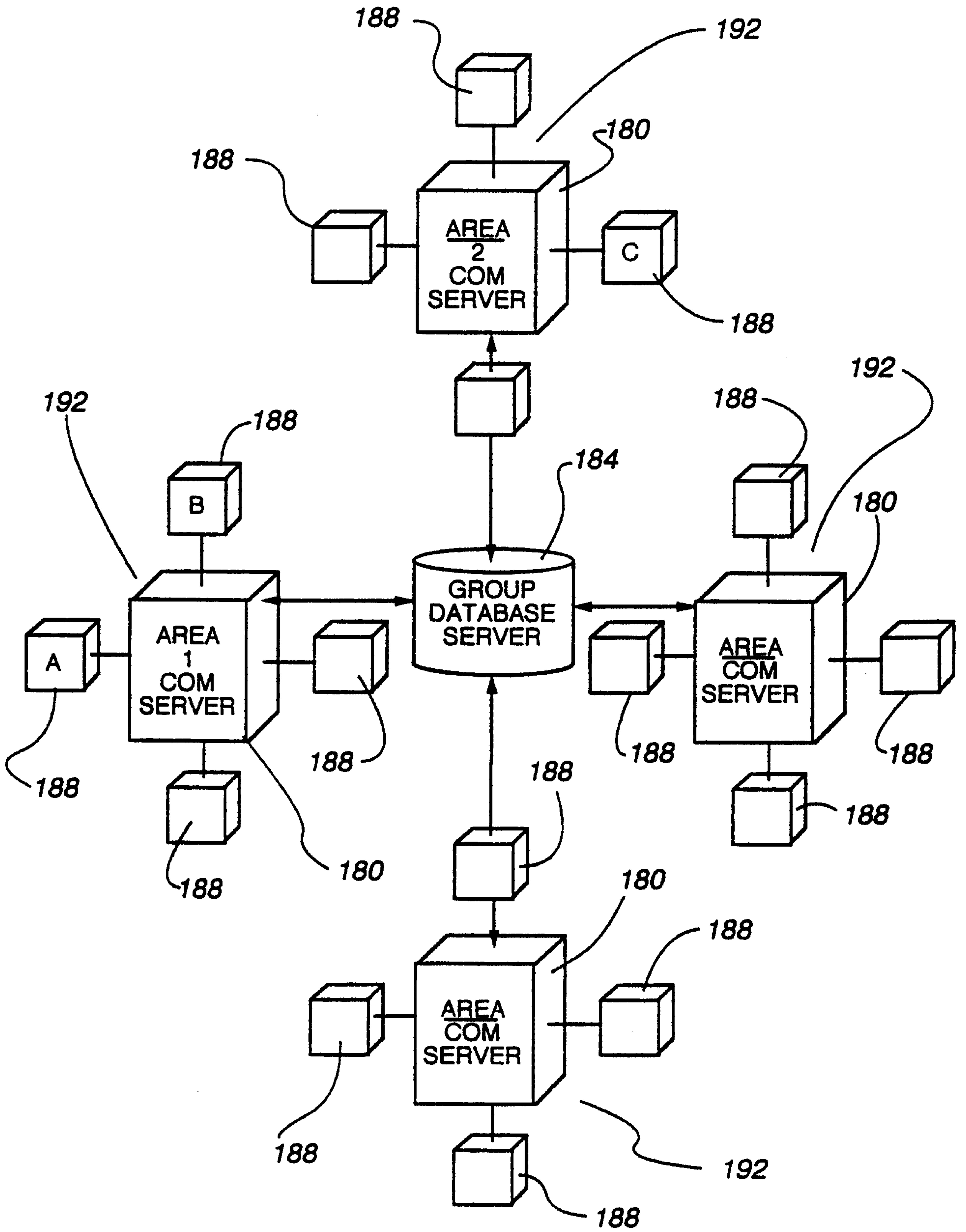

Fig. 9

+

8/15

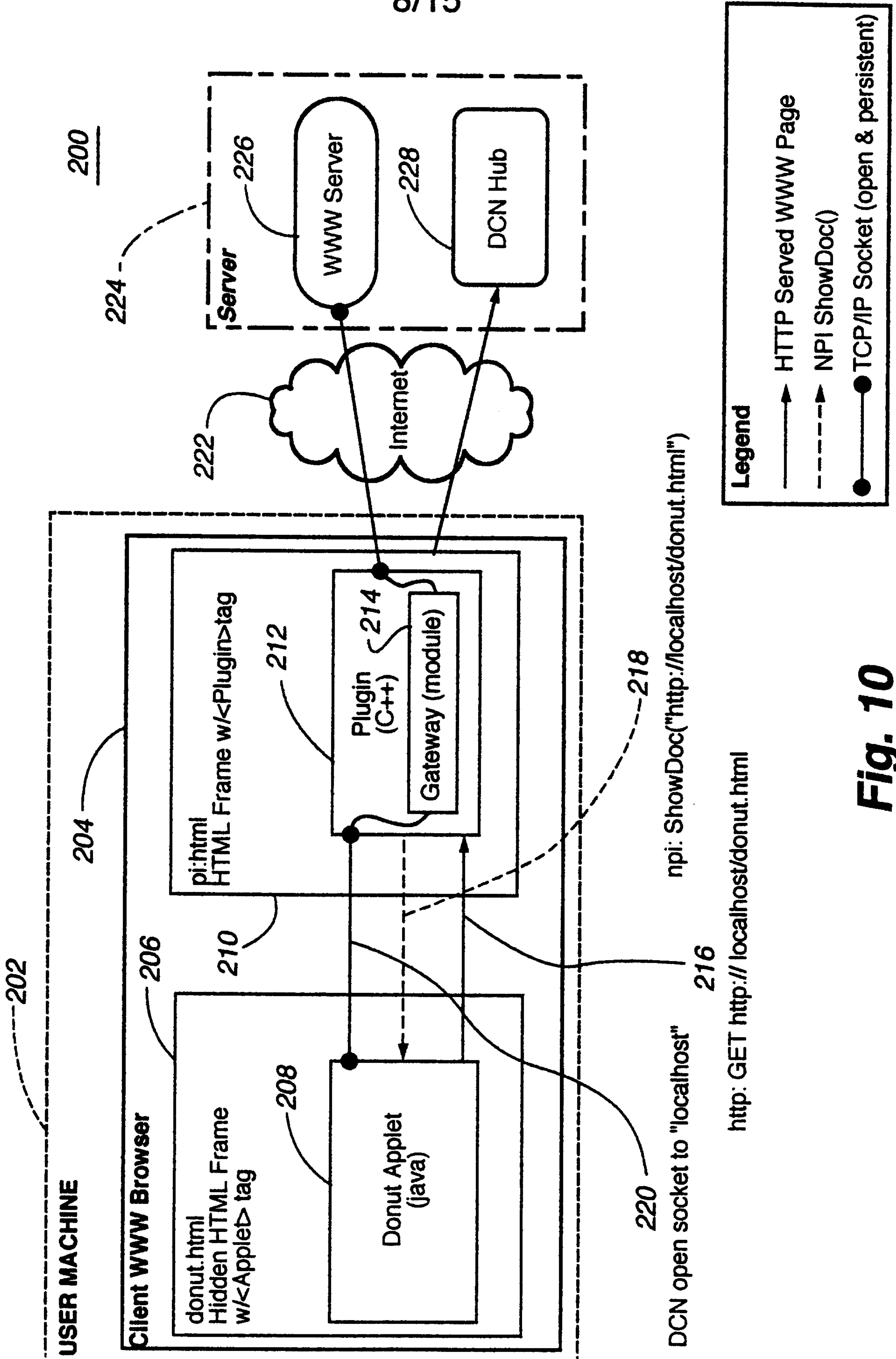

Fig. 10



9/15

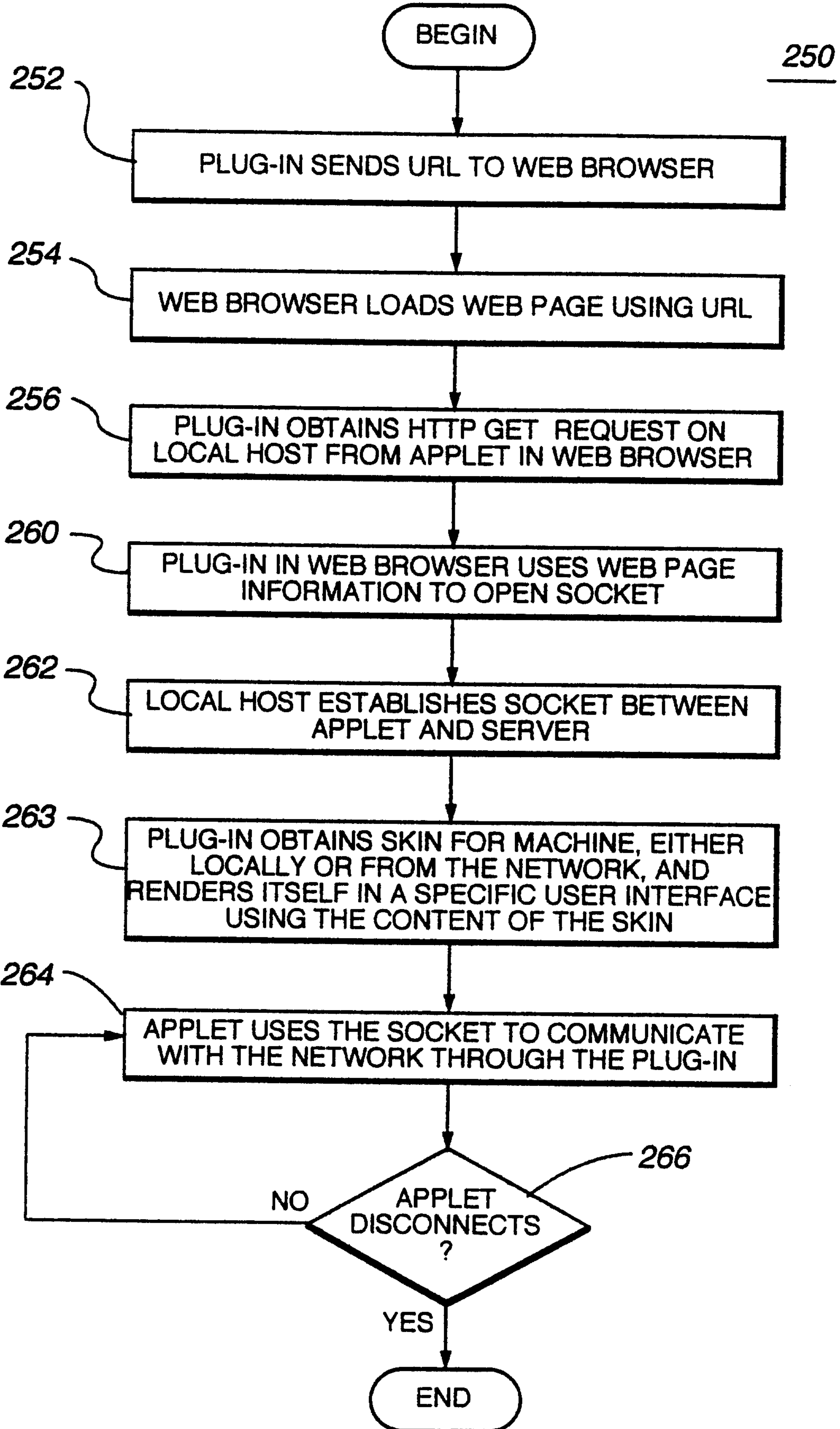

Fig. 11

+

The image shows a dialog box titled "Edit HyperTV URL" with a close button (X) in the top right corner. The dialog contains several fields and controls:

- 322**: A text field labeled "Descript." containing the text "Ford".
- 324**: A text field labeled "URL" containing the text "http://content.qa.actv.com/hypertvdemo/ads/ford.html".
- 326**: A dropdown menu labeled "Frame" with the selected option "actv_ad".
- 328**: A dropdown menu labeled "FmSet" with the selected option "Triple".
- Below the "FmSet" dropdown, there are three numeric input fields for time selection: "Hour" (00), "Min" (00), and "Sec" (13).
- At the bottom left, there is a checkbox labeled "CDROM" which is currently unchecked.
- At the bottom right, there are two buttons: "Add" and "Cancel".

Reference numerals 330, 332, and 334 point to the overall dialog box, the "Add" button, and the "Cancel" button, respectively.

Fig. 13

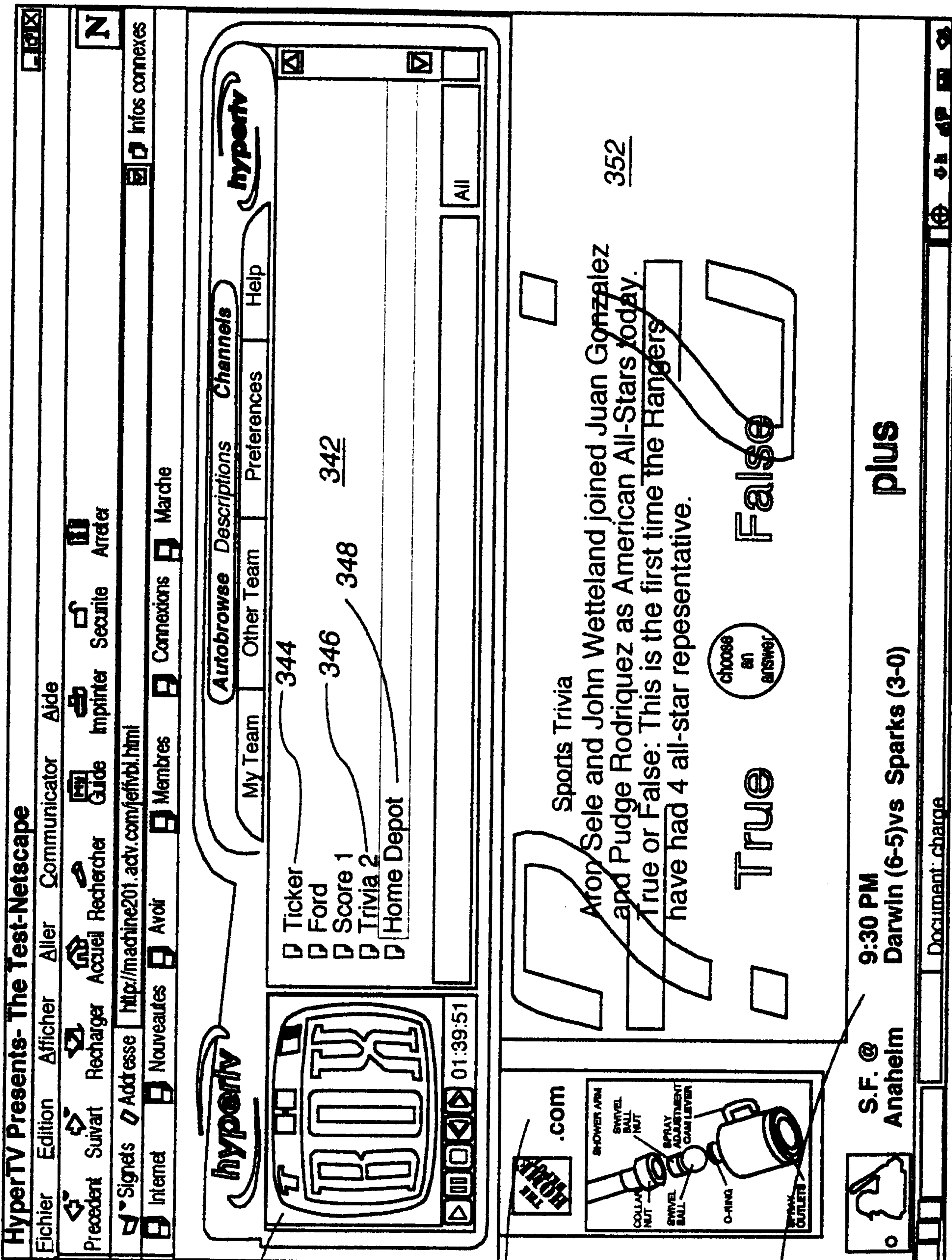

340

356

350

354

fig. 14

13/15

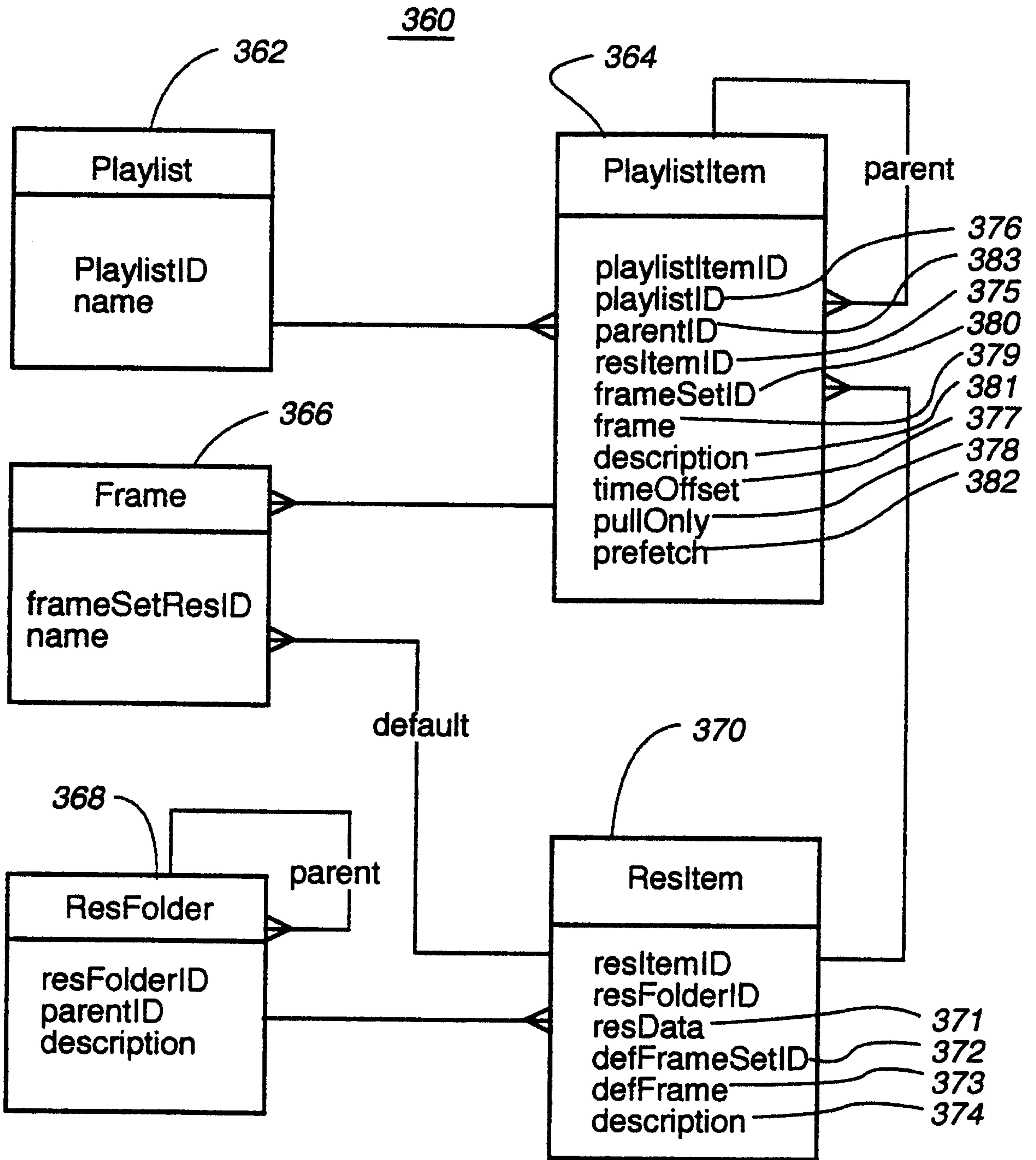

Fig. 15

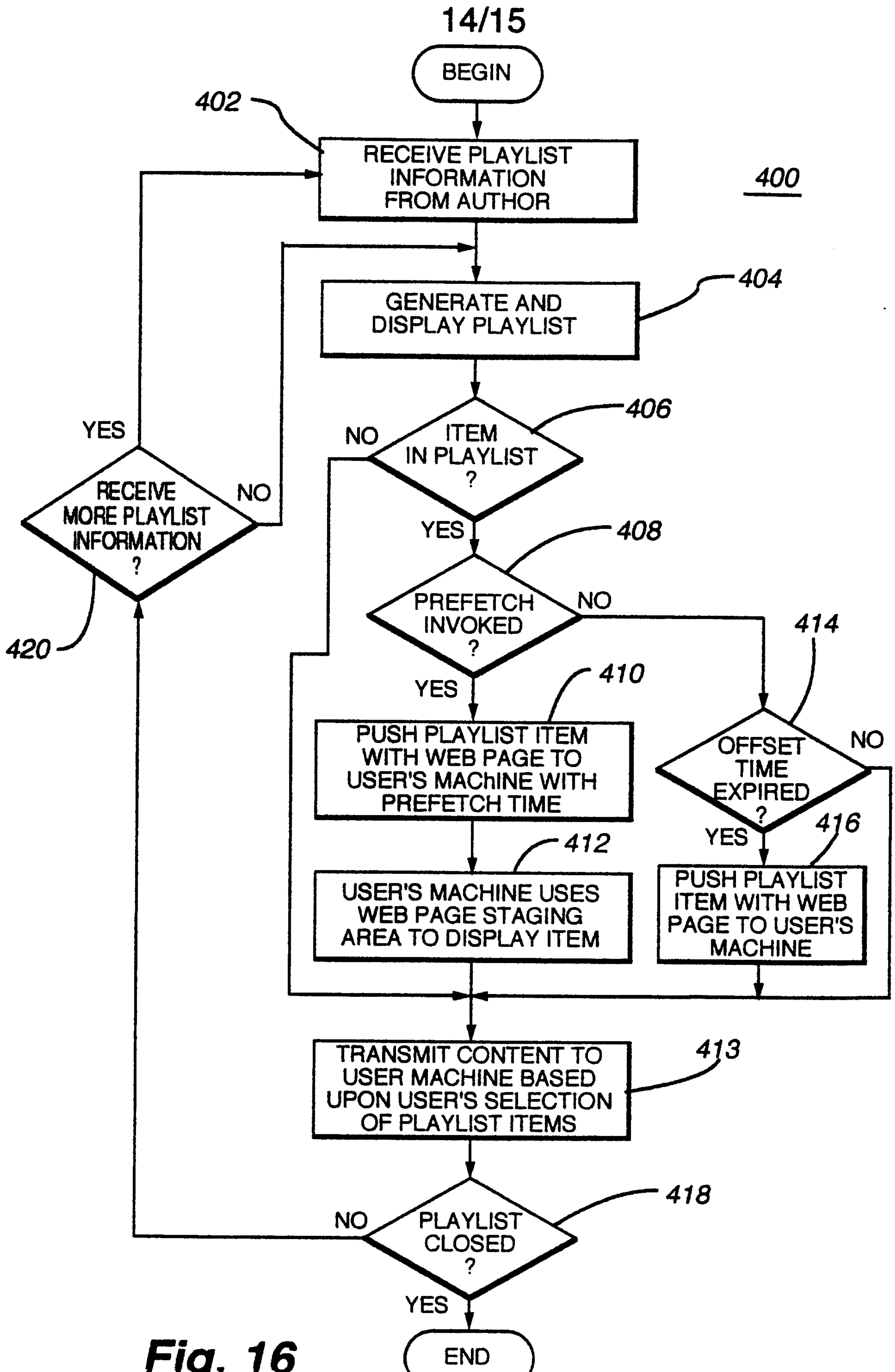
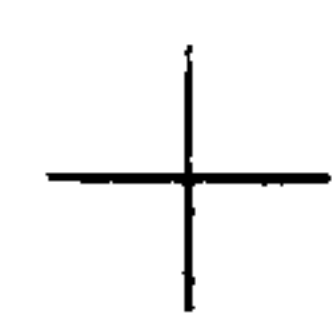

Fig. 16



15/15

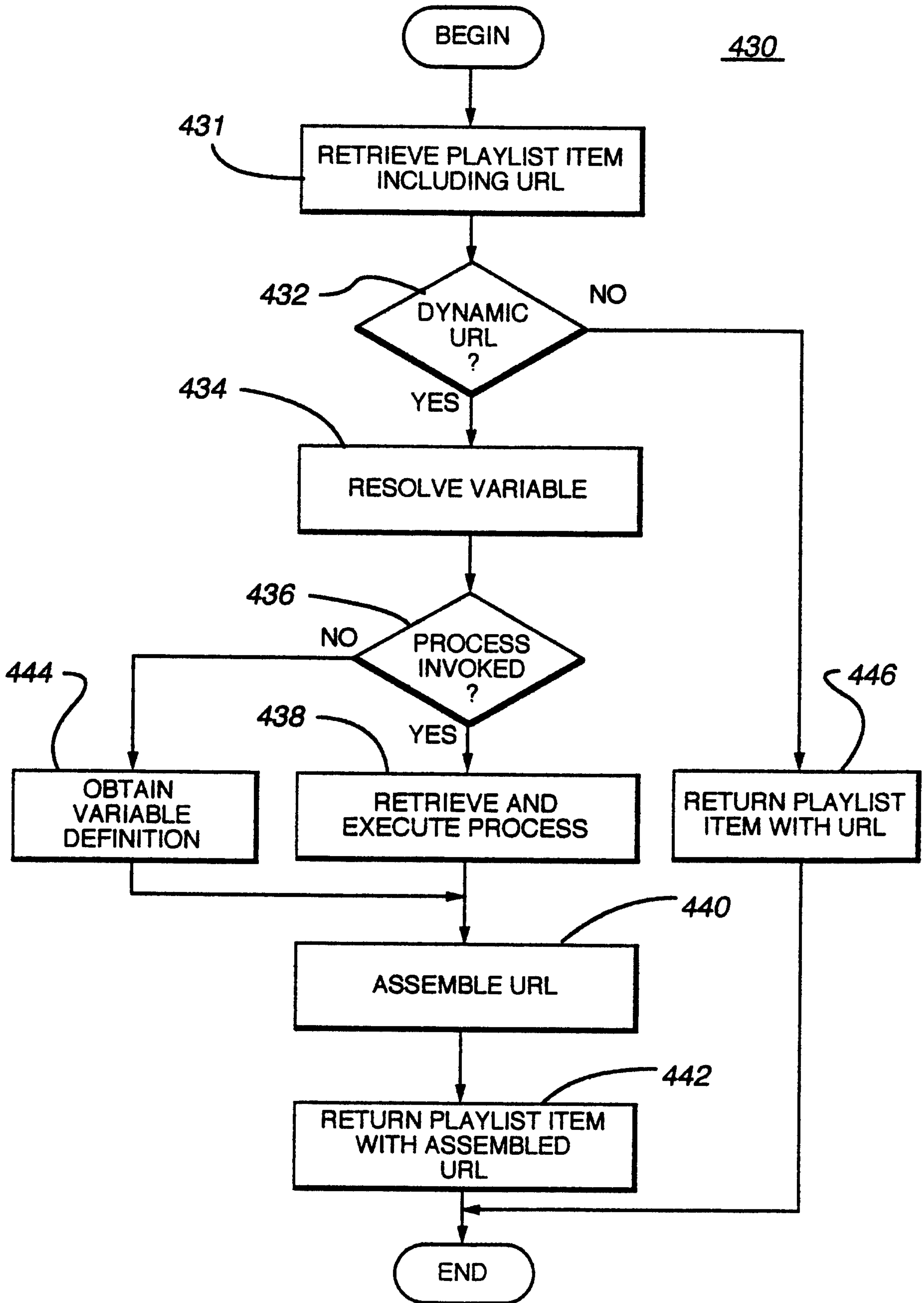

Fig. 17

2328796

UNSCANNABLE ITEM

RECEIVED WITH THIS APPLICATION

(ITEM ON THE 10TH FLOOR ZONE 5 IN THE FILE PREPARATION SECTION)

DOCUMENT REÇU AVEC CETTE DEMANDE

NE POUVANT ÊTRE BALAYÉ

(DOCUMENT AU 10 IÈME ÉTAGE AIRE 5 DANS LA SECTION DE LA
PRÉPARATION DES DOSSIERS)

