



US00D347802S

United States Patent [19]

[11] Patent Number: Des. 347,802

Kielbasa

[45] Date of Patent: ** Jun. 14, 1994

- [54] CHRISTMAS ORNAMENTAL DISPLAY
- [75] Inventor: Karen T. Kielbasa, Hong Kong, Hong Kong
- [73] Assignee: Mr. Christmas, Inc., New York, N.Y.
- [**] Term: 14 Years
- [21] Appl. No.: 4,833
- [22] Filed: Dec. 7, 1992
- [52] U.S. Cl. D11/121; D11/125; D11/157; D11/159; D20/30
- [58] Field of Search 362/249, 252, 806, 808; 40/411, 414, 421, 423; D11/117, 121, 125, 133, 135, 157, 159; D26/25; D21/59; D20/30

[56] **References Cited**

U.S. PATENT DOCUMENTS

D. 65,741	10/1924	Hartman	D21/64
D. 136,448	10/1943	Kimmich	D11/165
D. 215,304	9/1969	Kadmon et al.	D26/25
674,970	5/1901	Kennedy	40/411 X
2,107,641	2/1938	Malcomson	D11/125 X
2,307,296	1/1943	Peyton	40/411 X
5,067,061	11/1991	Prichett	362/806 X

Primary Examiner—Bernard Ansher
Assistant Examiner—Dominic Simone

[57] **CLAIM**

The ornamental design for a christmas ornamental display, as shown and described.

DESCRIPTION

FIG. 1 is a perspective view of an ornamental display showing my new design;
FIG. 2 is a front elevational view of the wagon of the display of FIG. 1;

FIG. 3 is a left-side elevational view of the wagon depicted in FIG. 2;
FIG. 4 is a right-side elevational view of the wagon depicted in FIG. 2;
FIG. 5 is a top plan view of the wagon depicted in FIG. 2;
FIG. 6 is a bottom plan view of the wagon depicted in FIG. 2;
FIG. 7 is a front view of the upper left carousel horse and housing depicted in FIG. 1;
FIG. 8 is a back view of FIG. 7;
FIG. 9 is a bottom view of FIG. 7;
FIG. 10 is a top view of FIG. 7;
FIG. 11 is a right side view of FIG. 7;
FIG. 12 is a left side view of FIG. 7;
FIG. 13 is a front view of the upper right carousel horse and housing depicted in FIG. 1;
FIG. 14 is a back view of FIG. 13;
FIG. 15 is a bottom view of FIG. 13;
FIG. 16 is a top view of FIG. 13;
FIG. 17 is a right side view of FIG. 13;
FIG. 18 is a left side view of FIG. 13;
FIG. 19 is a front view of the lower left-most carousel horse and housing depicted in FIG. 1;
FIG. 20 is a back view of FIG. 19;
FIG. 21 is a bottom view of FIG. 19;
FIG. 22 is a top view of FIG. 19;
FIG. 23 is a right side view of FIG. 19;
FIG. 24 is a left side view of FIG. 19;
FIG. 25 is a front view of the lower, second from the left carousel horse and housing depicted in FIG. 1;
FIG. 26 is a back view of FIG. 25;
FIG. 27 is a bottom view of FIG. 25;
FIG. 28 is a top view of FIG. 25;
FIG. 29 is a right side view of FIG. 25; and,
FIG. 30 is a left side view of FIG. 25.
The elements of the claimed design are shown separately for clarity of illustration.

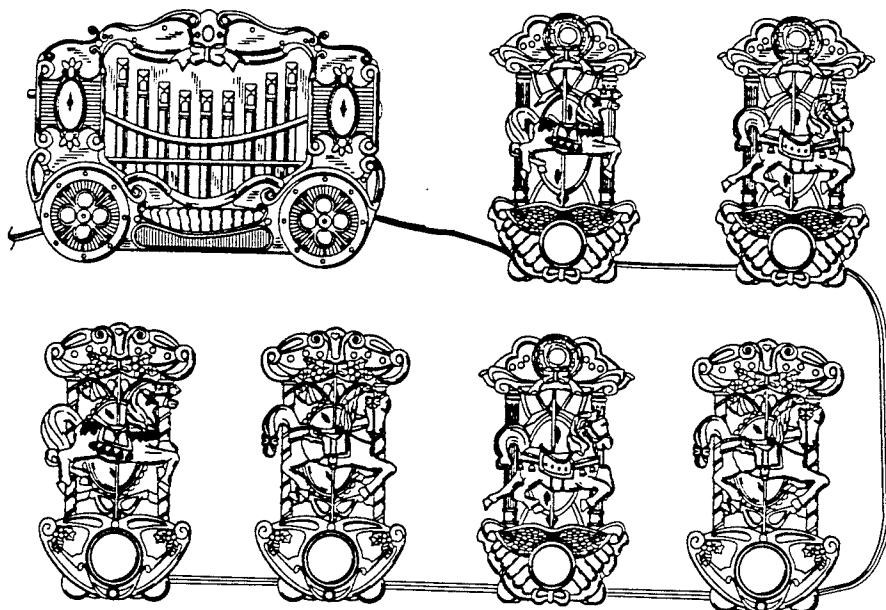

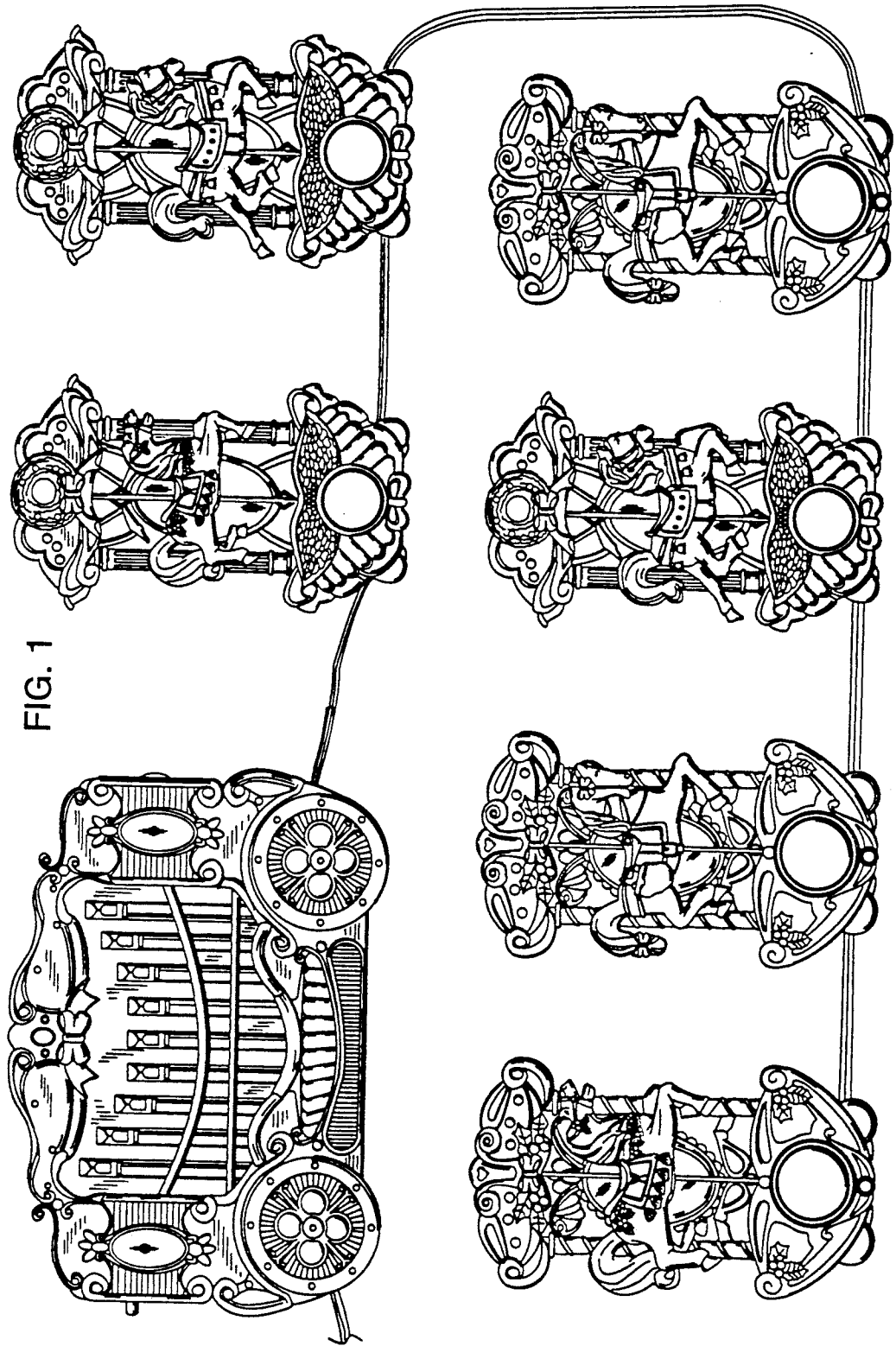

FIG. 1

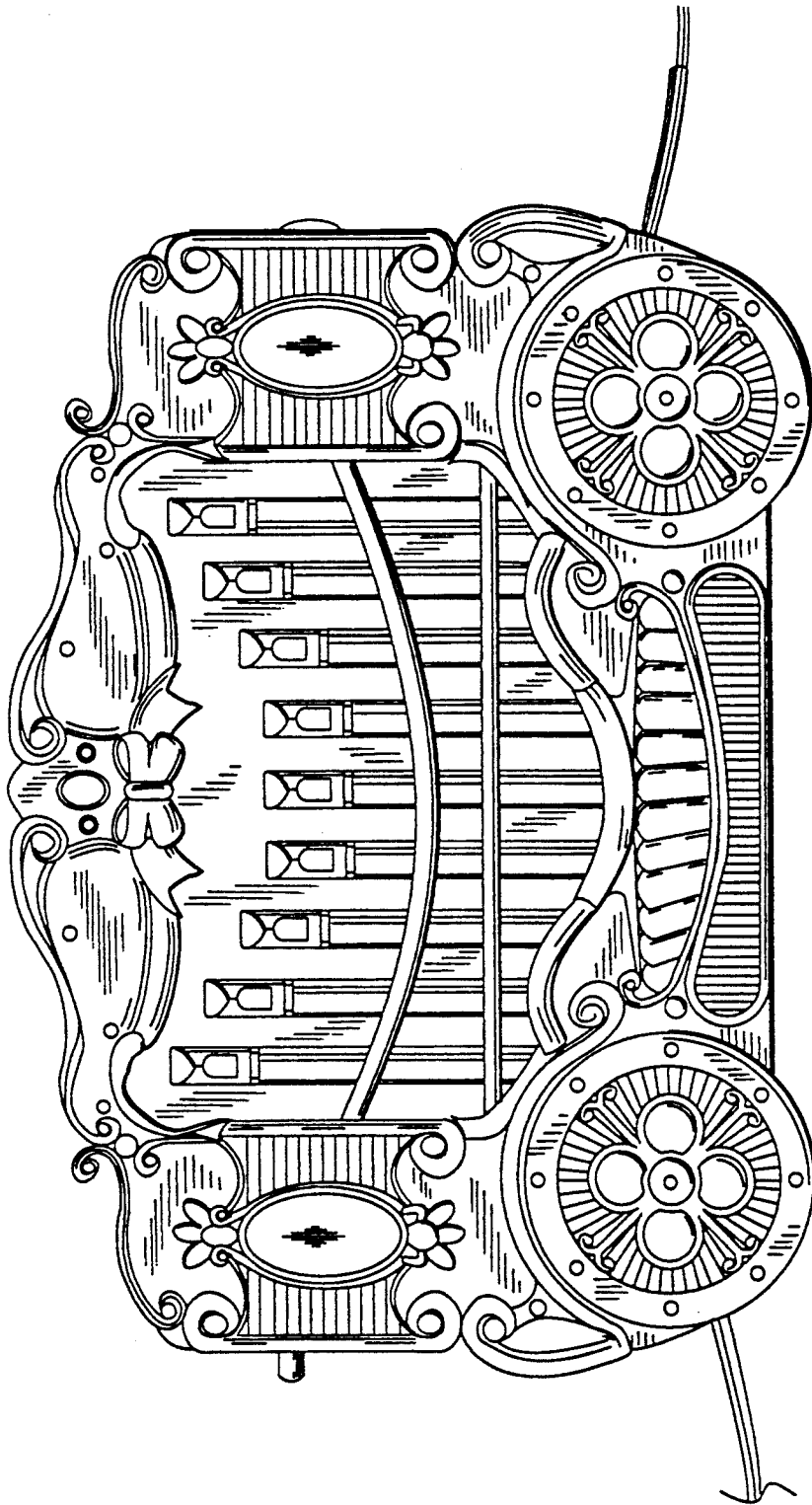

FIG. 2

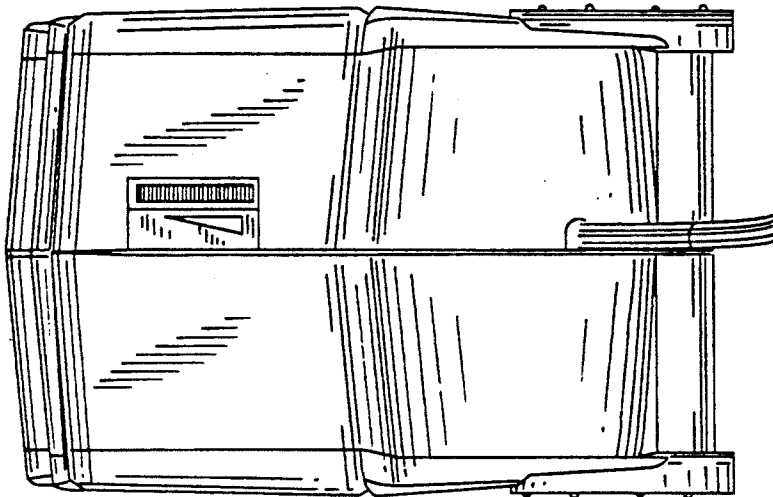

FIG. 4

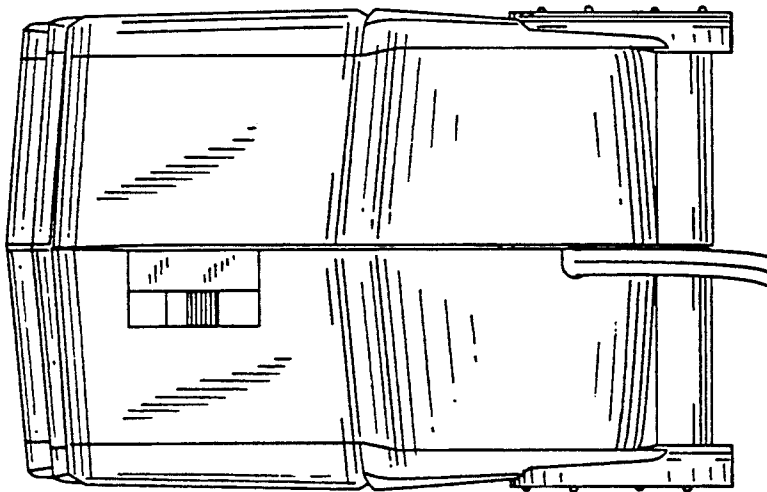

FIG. 3

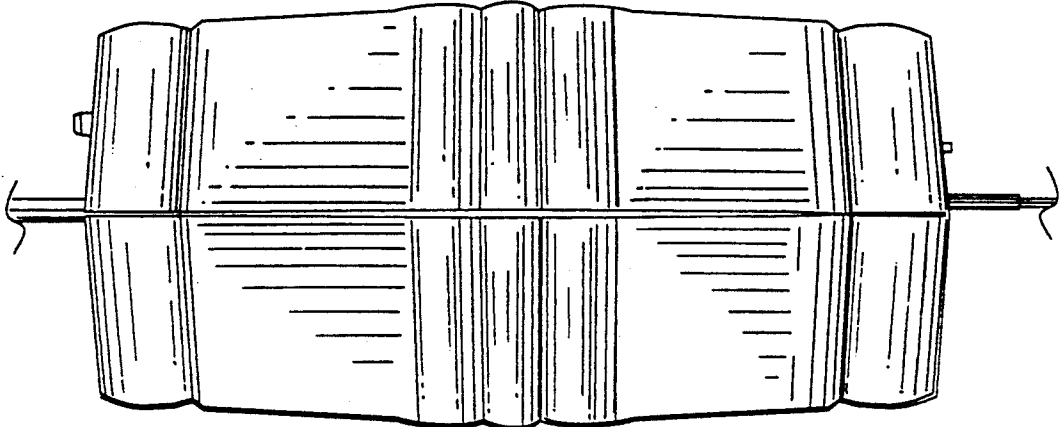

FIG. 5

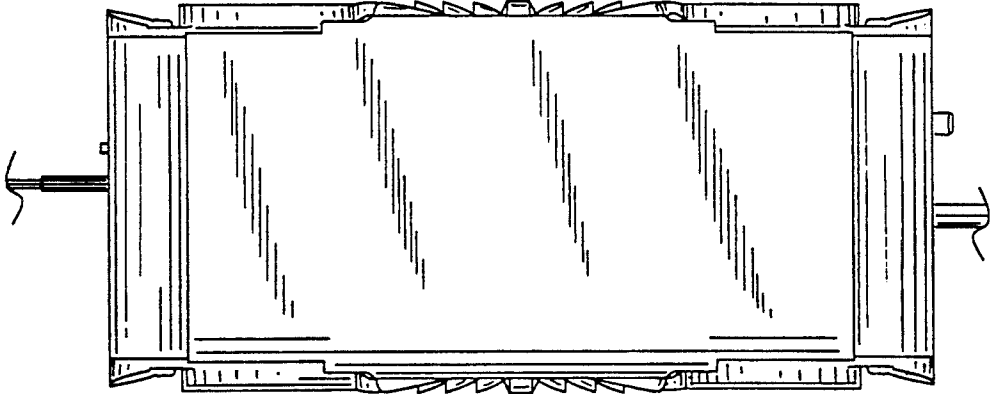

FIG. 6

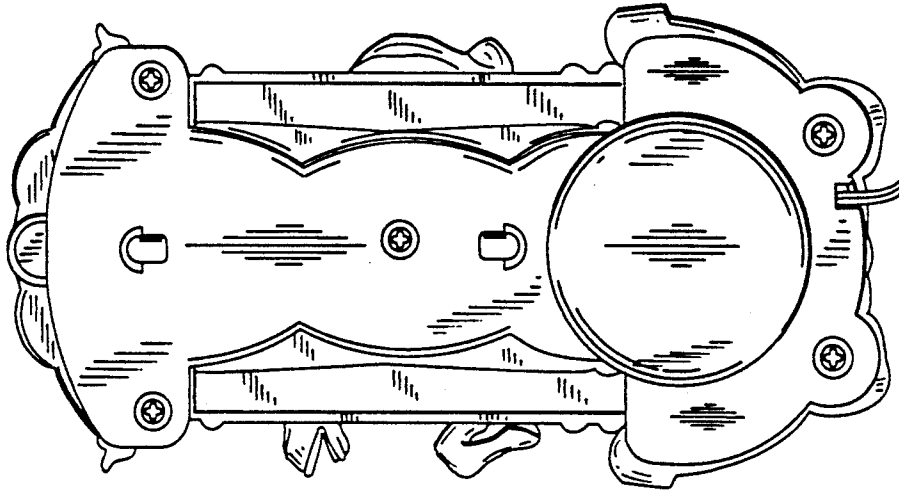

FIG. 8

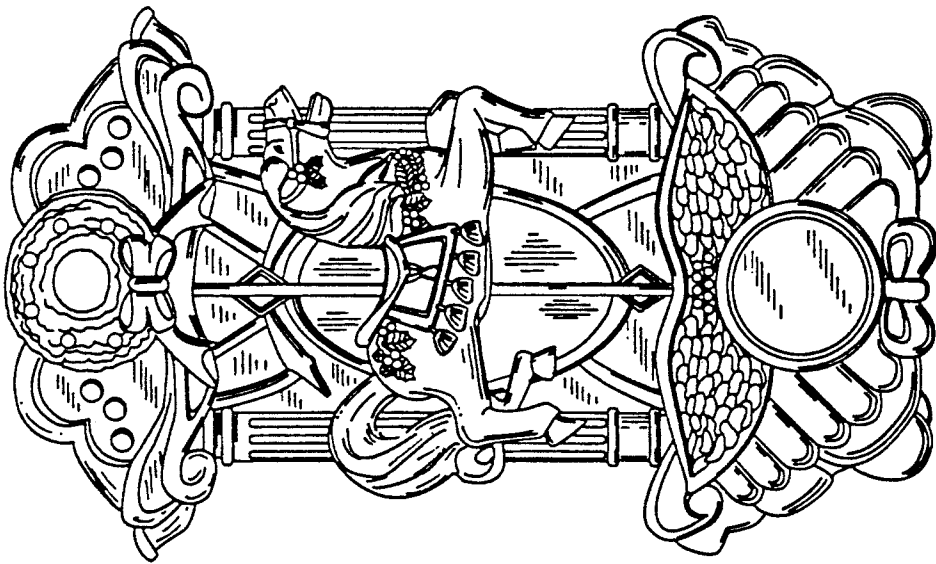

FIG. 7

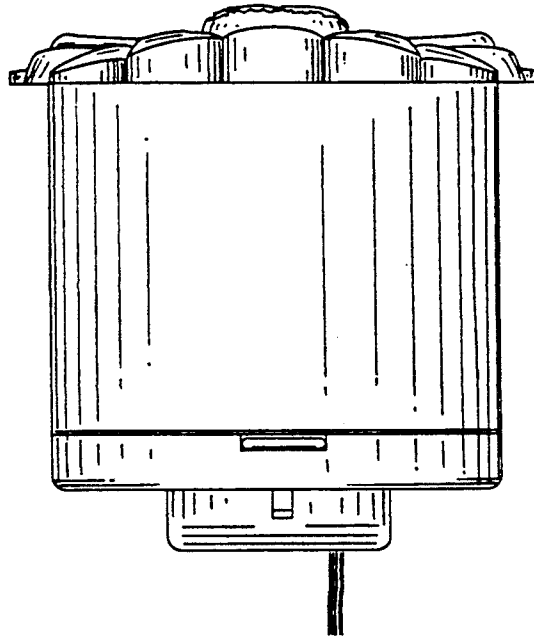

FIG. 9

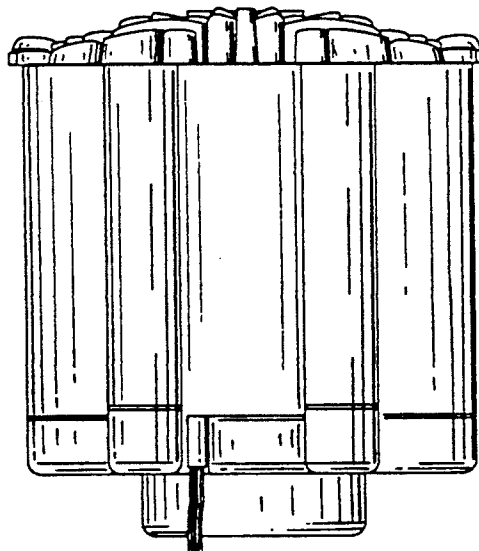

FIG. 10

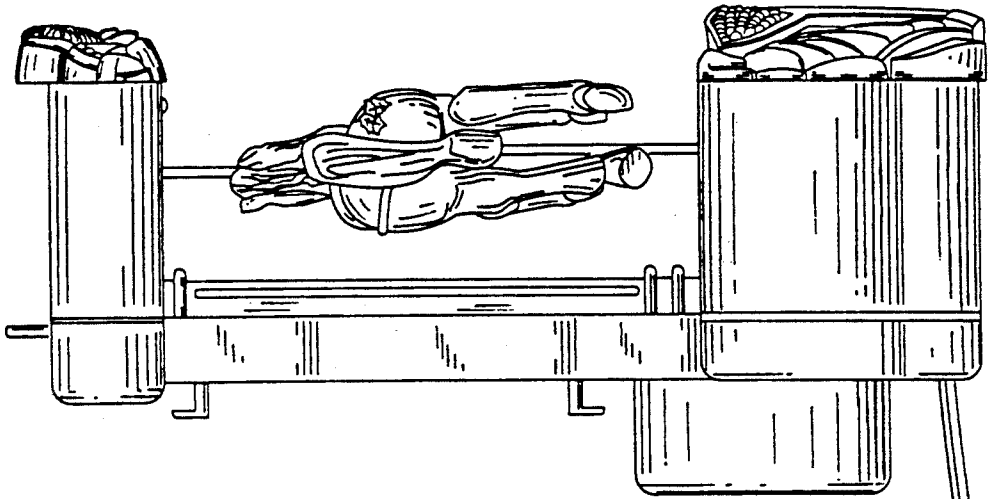

FIG. 12

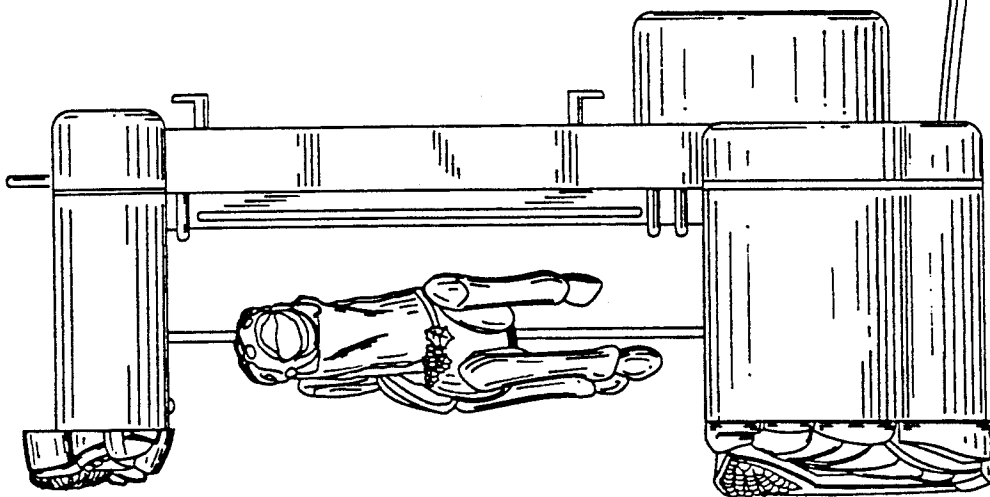

FIG. 11

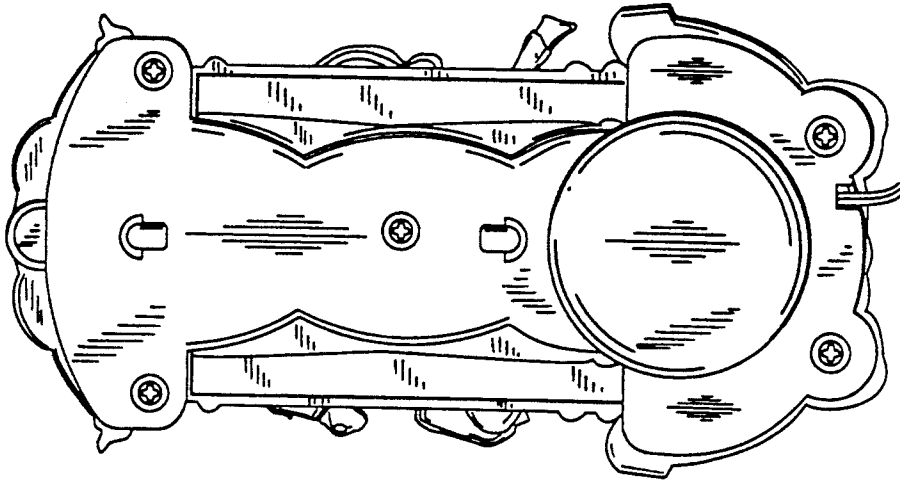

FIG. 14

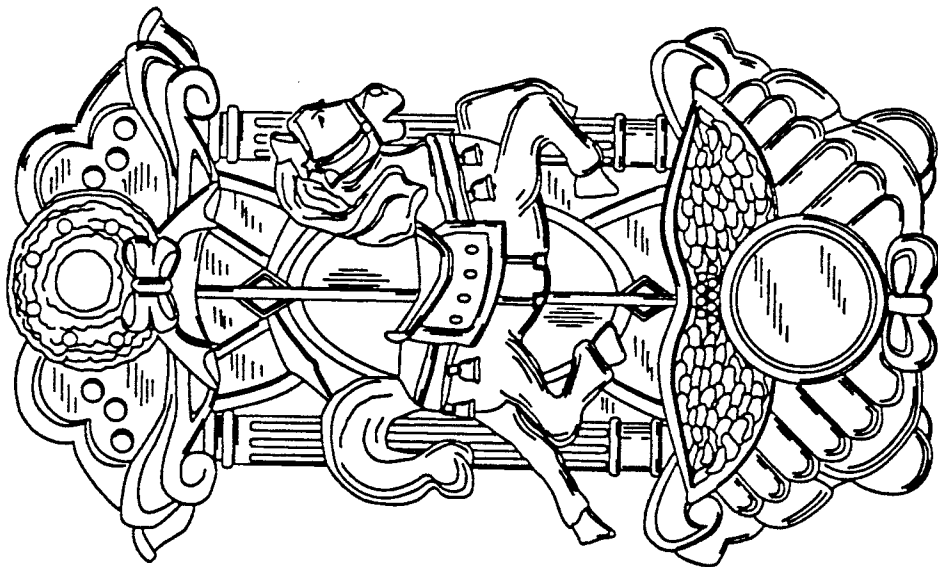

FIG. 13

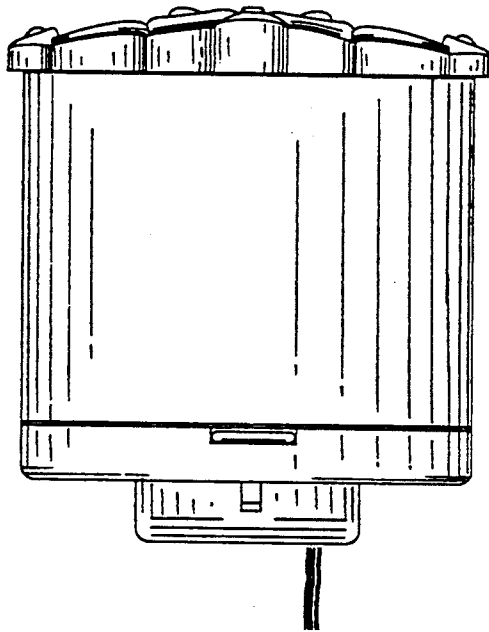

FIG. 15

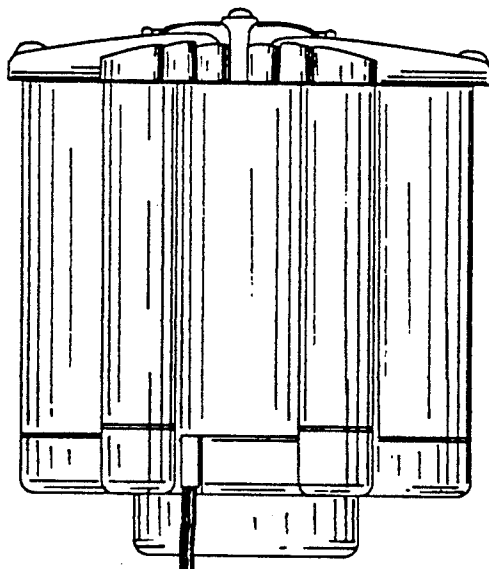

FIG. 16

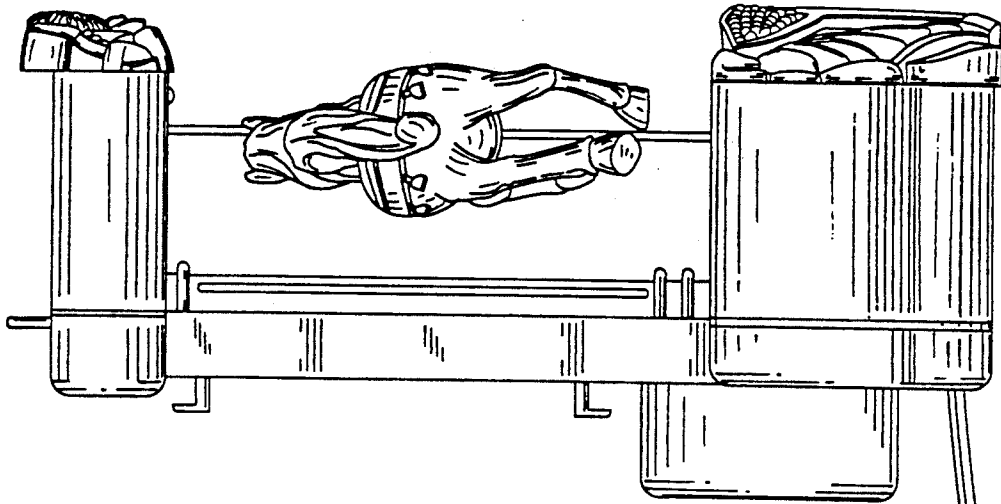

FIG. 18

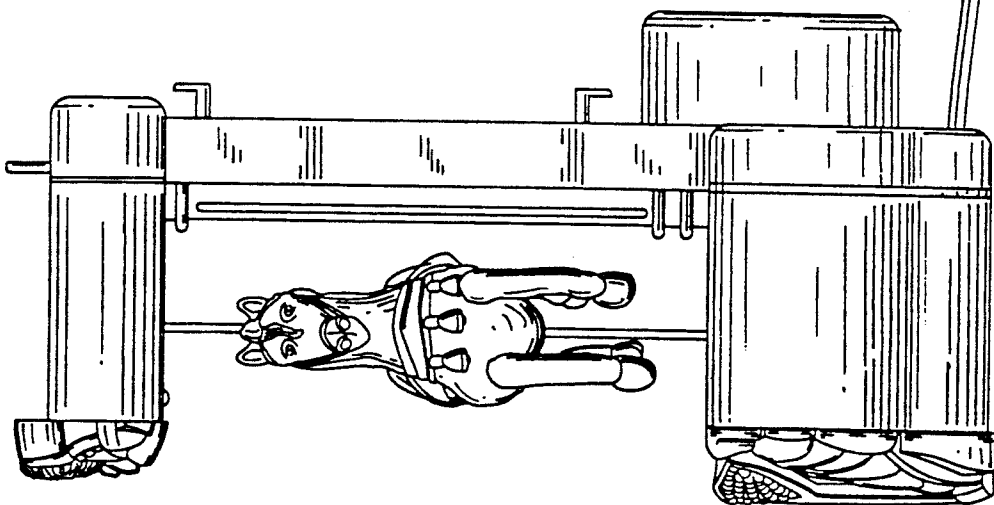

FIG. 17

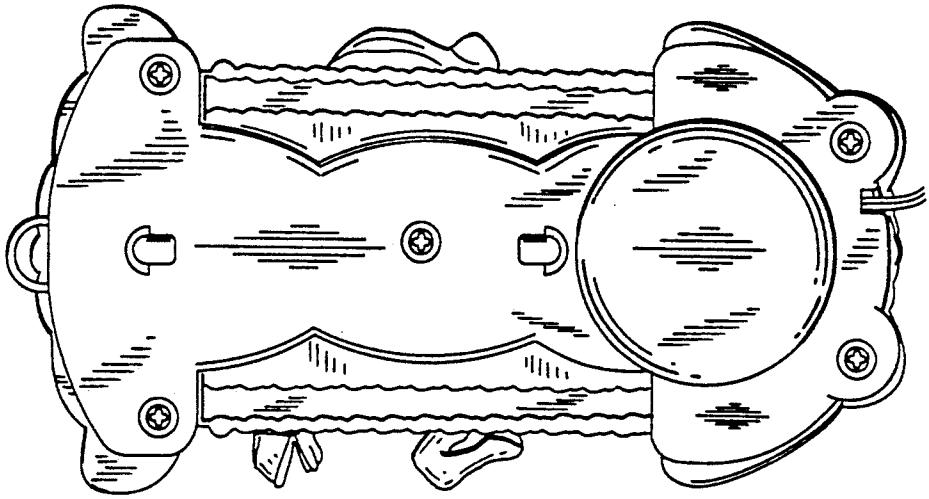

FIG. 20

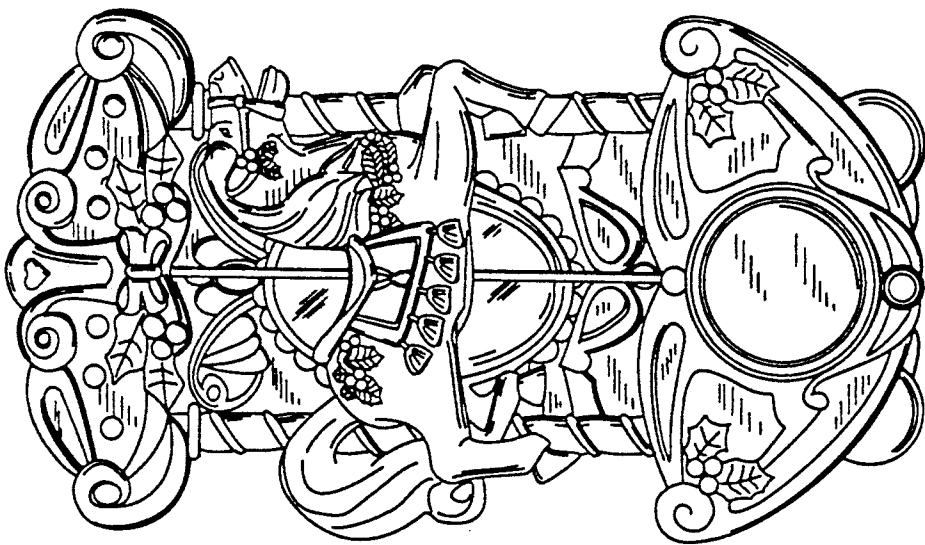

FIG. 19

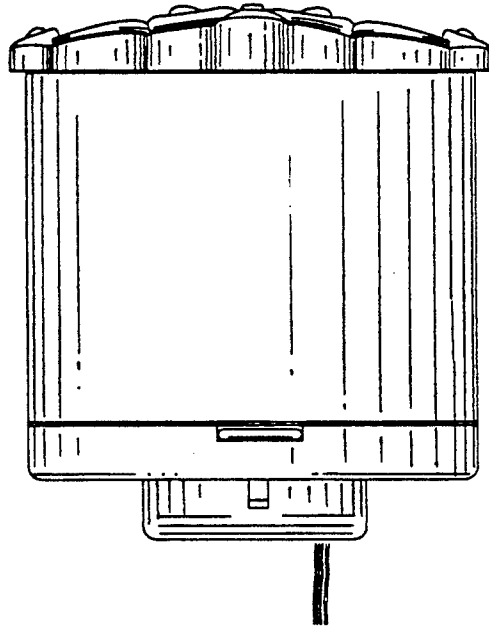

FIG. 21

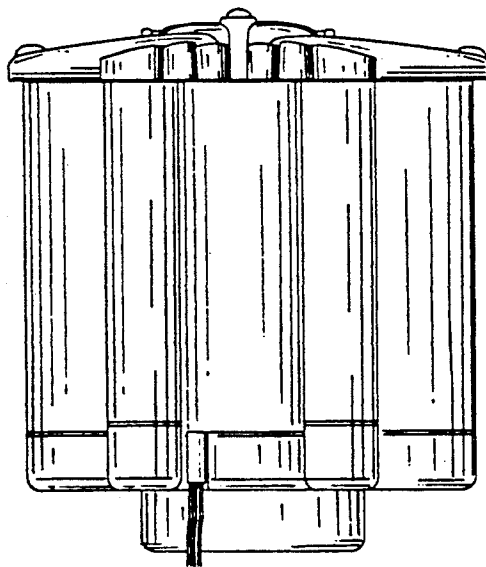

FIG. 22

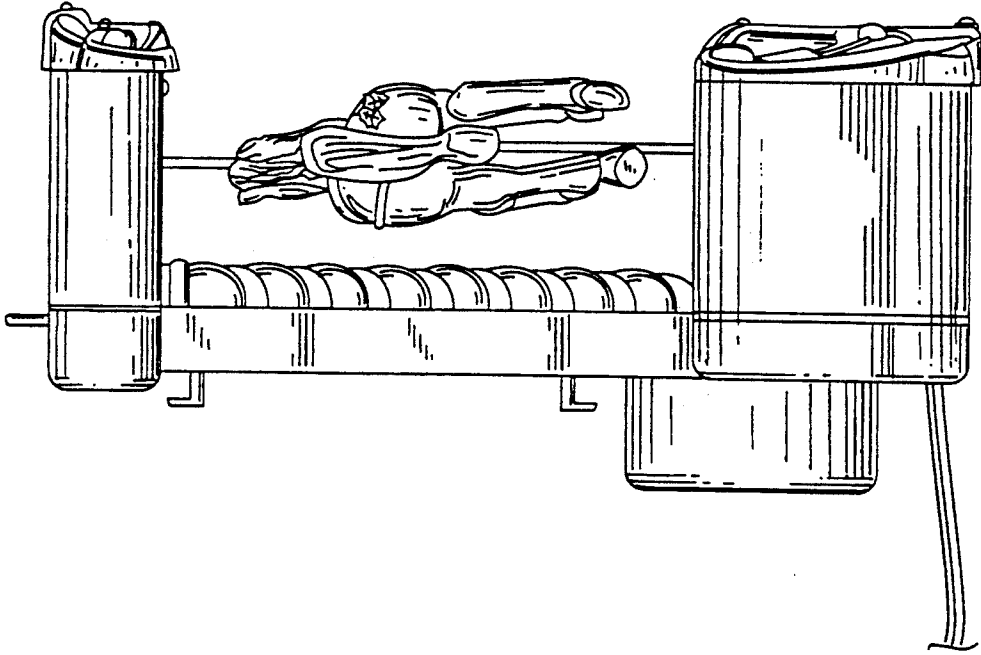

FIG. 24

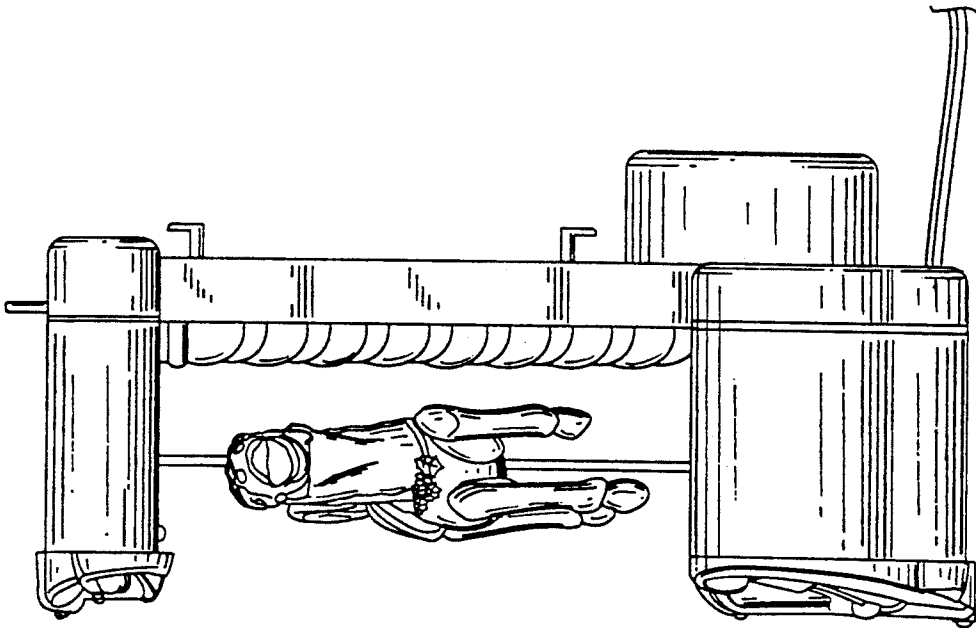

FIG. 23

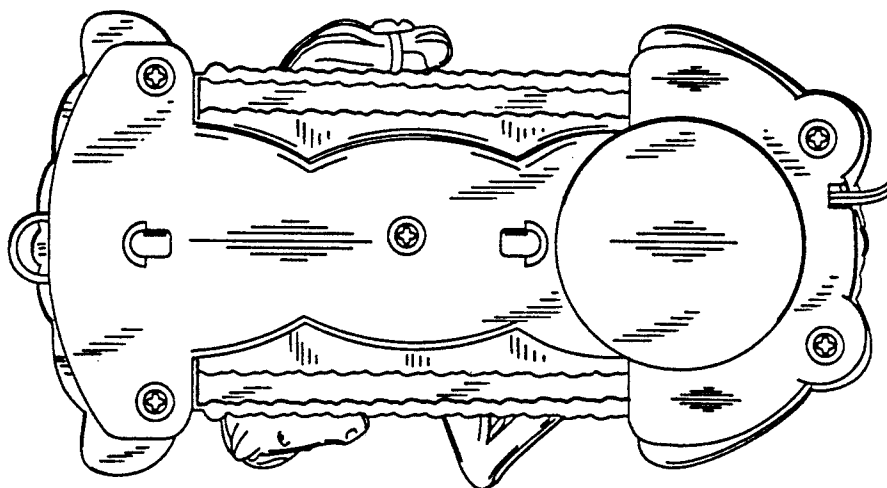

FIG. 26

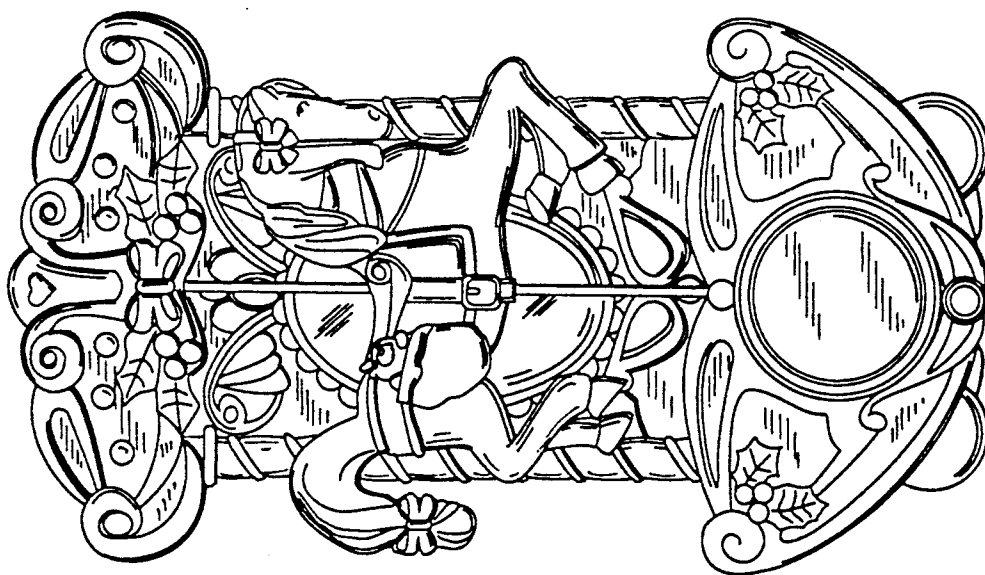

FIG. 25

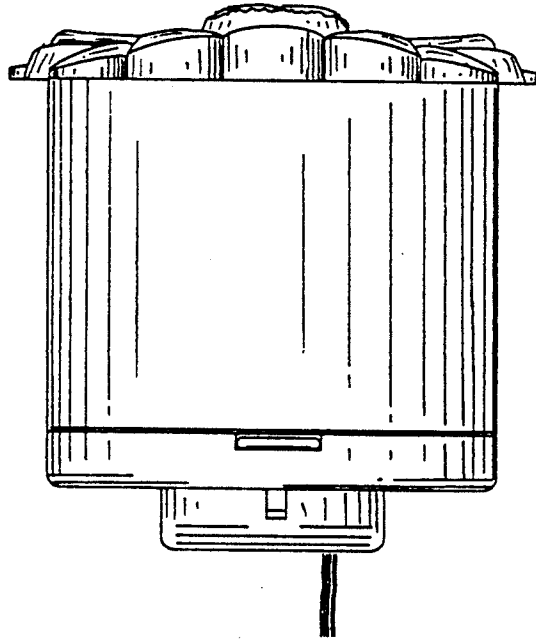

FIG. 27

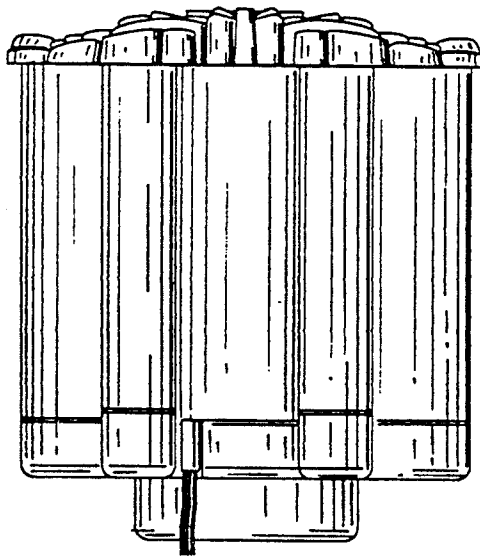

FIG. 28

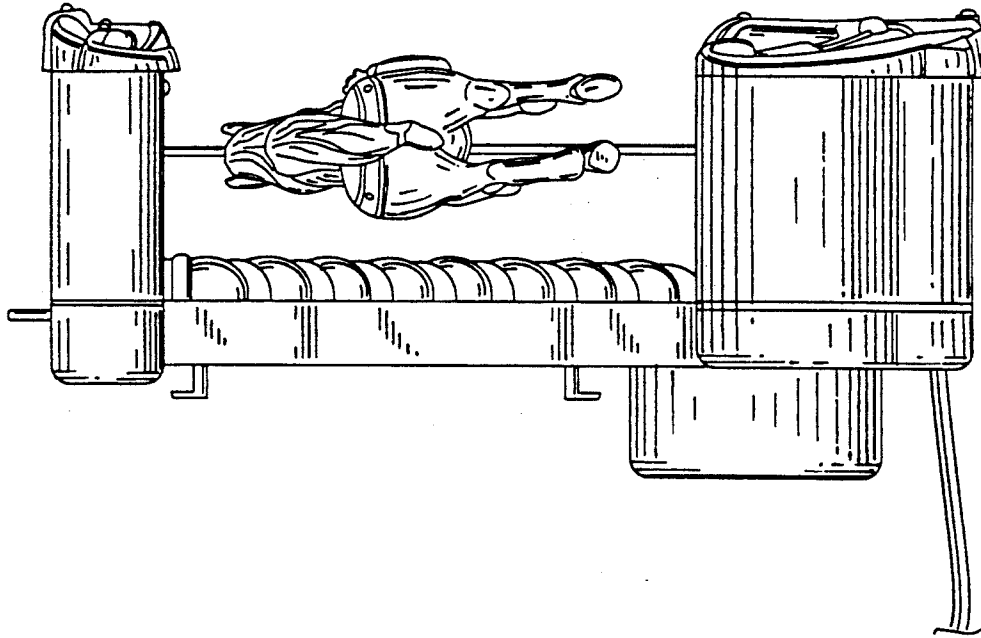

FIG. 30

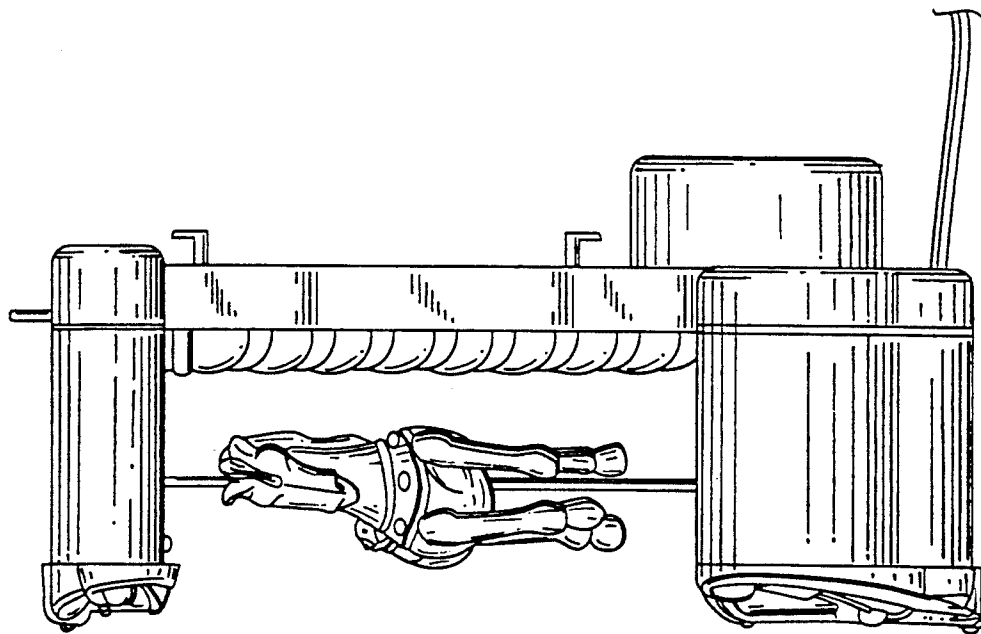

FIG. 29