



US00D413202S

United States Patent [19]
Schmitt et al.

[11] **Patent Number: Des. 413,202**

[45] **Date of Patent: ** Aug. 31, 1999**

[54] **CARRYING CASE**

[75] Inventors: **David Schmitt**, Hastings; **Jon Leikvold**, Minneapolis; **James Wilson**, North St. Paul, all of Minn.; **Jeremy Odegard**, River Falls, Wis.; **Tom Viker**, Roseville, Minn.

[73] Assignee: **Gemini, Inc.**, Cannon Falls, Minn.

[**] Term: **14 Years**

[21] Appl. No.: **29/094,211**

[22] Filed: **Sep. 28, 1998**

[51] **LOC (6) Cl.** **03-01**

[52] **U.S. Cl.** **D3/276; D3/294**

[58] **Field of Search** **D3/273, 272, 276, D3/281, 282, 283, 291, 294, 295; D9/420, 423, 424; 190/100, 111, 112, 113; 206/315.1, 349, 372, 373**

[56] **References Cited**

U.S. PATENT DOCUMENTS

D. 275,822 10/1984 Gatland et al. D3/282

D. 289,582 5/1987 Brush, Jr. et al. D3/281
D. 314,666 2/1991 Lanius D3/281
D. 316,332 4/1991 Bridges et al. D9/424
D. 332,889 2/1993 Ward D3/281
D. 342,609 12/1993 Brightbill D3/294
D. 364,957 12/1995 Turbowitz D3/276
D. 369,240 4/1996 Newby, Sr. D3/276

Primary Examiner—Philip S. Hyder
Attorney, Agent, or Firm—Haugen Law Firm PLLP

[57] **CLAIM**

The ornamental design for a carrying case, as shown and described.

DESCRIPTION

FIG. 1 is a perspective view of the carrying case with the latches of the case raised and the cover of the carrying case partially raised;

FIG. 2 is an elevational front view of the carrying case;

FIG. 3 is an elevational rear view of the carrying case;

FIG. 4 is an elevational side view of the carrying case;

FIG. 5 is an elevational bottom view of the carrying case; and,

FIG. 6 is an elevational top view of the carrying case.

1 Claim, 6 Drawing Sheets

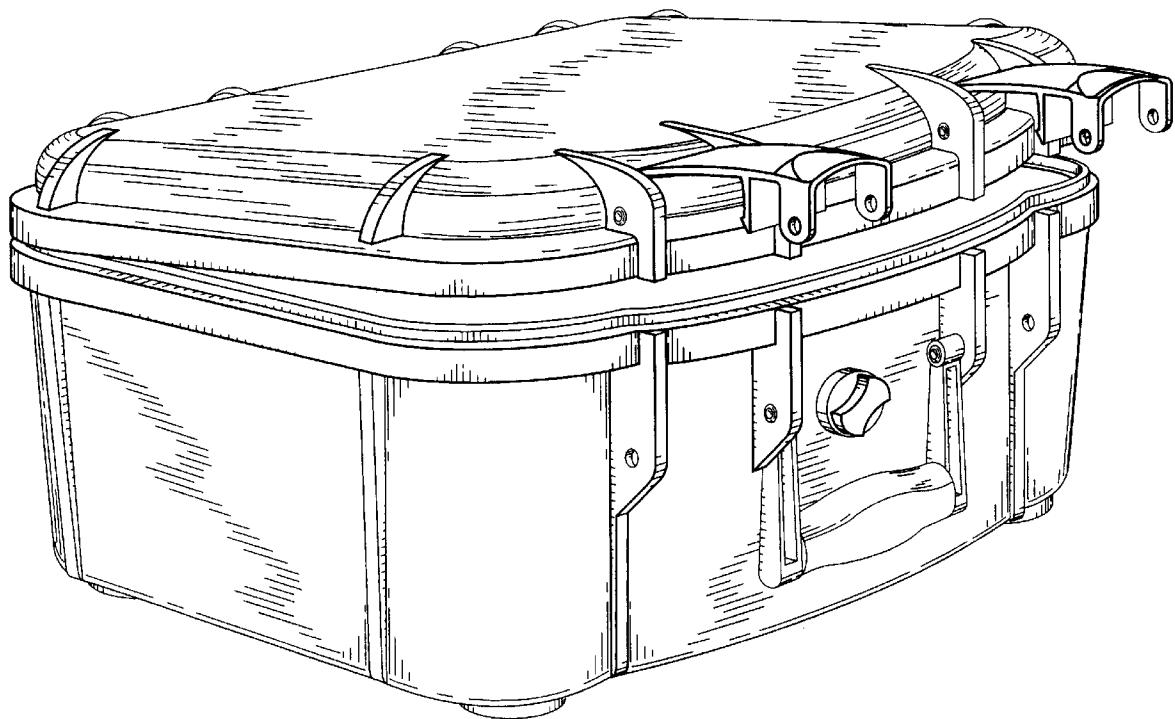

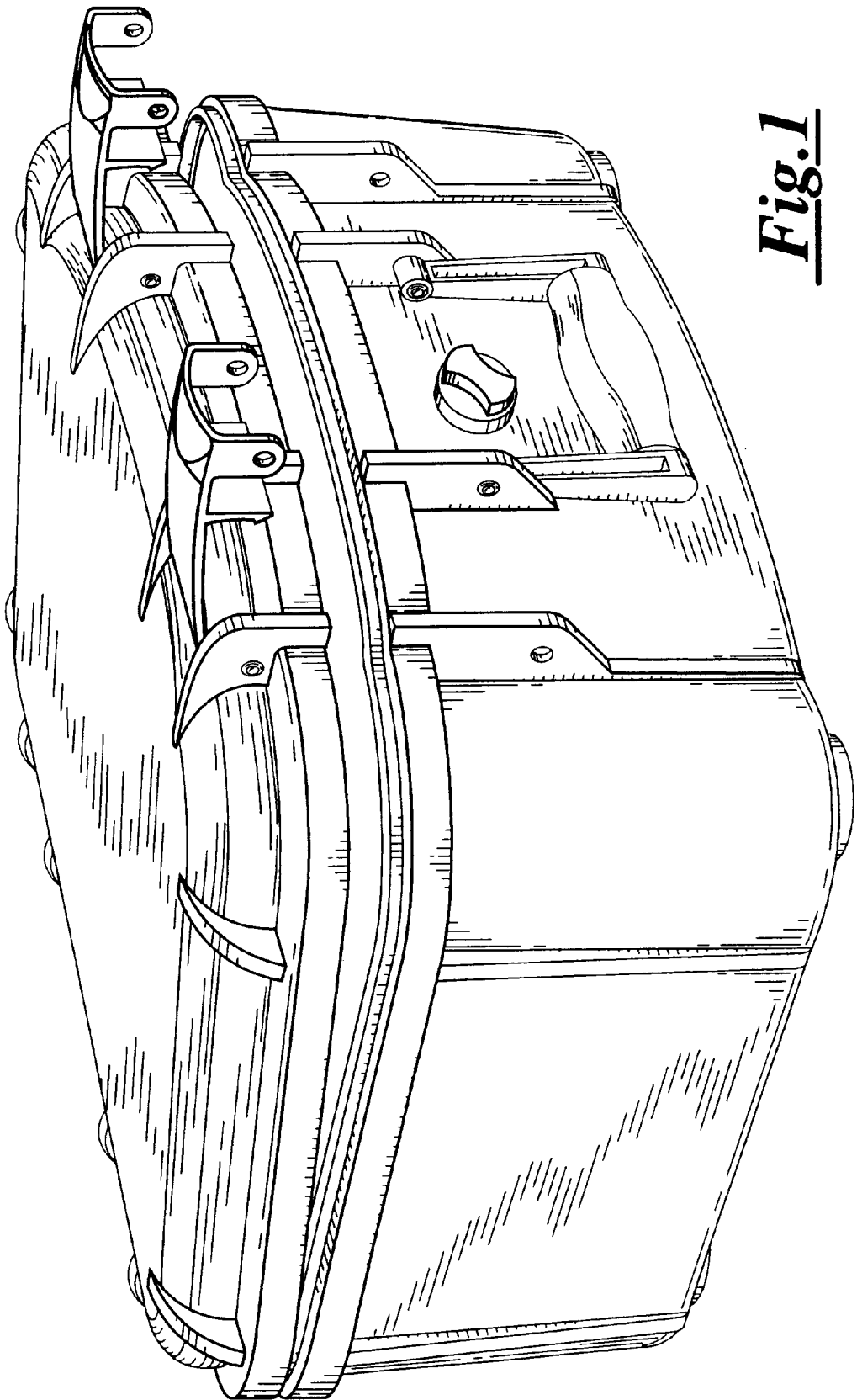

Fig. 1

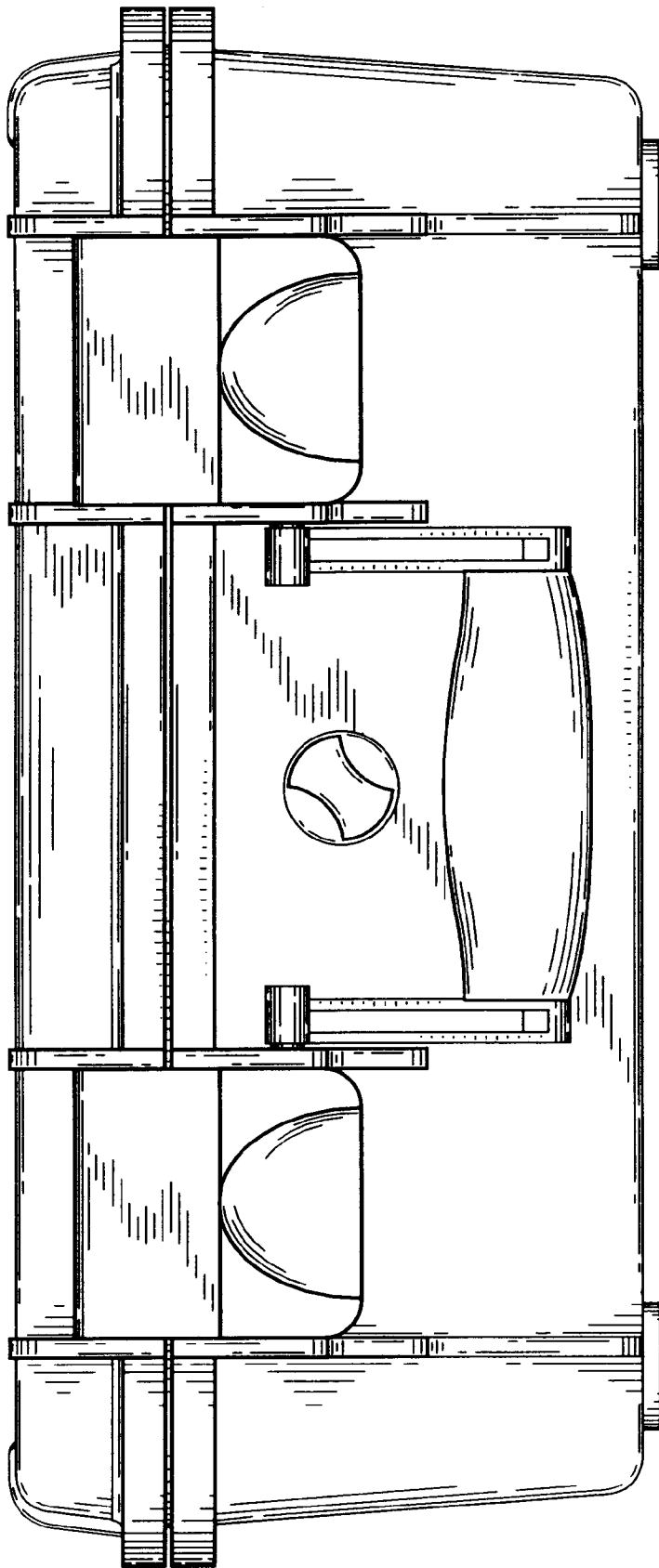

Fig. 2

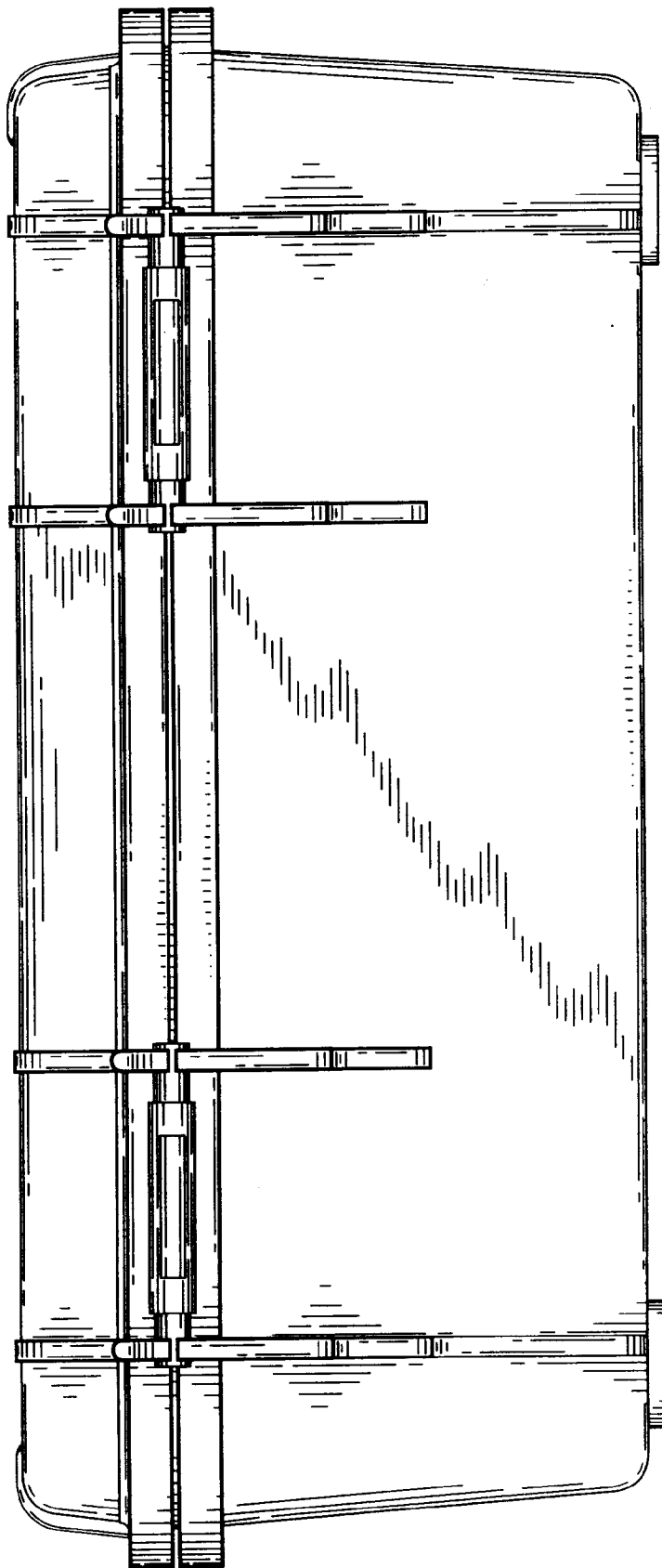
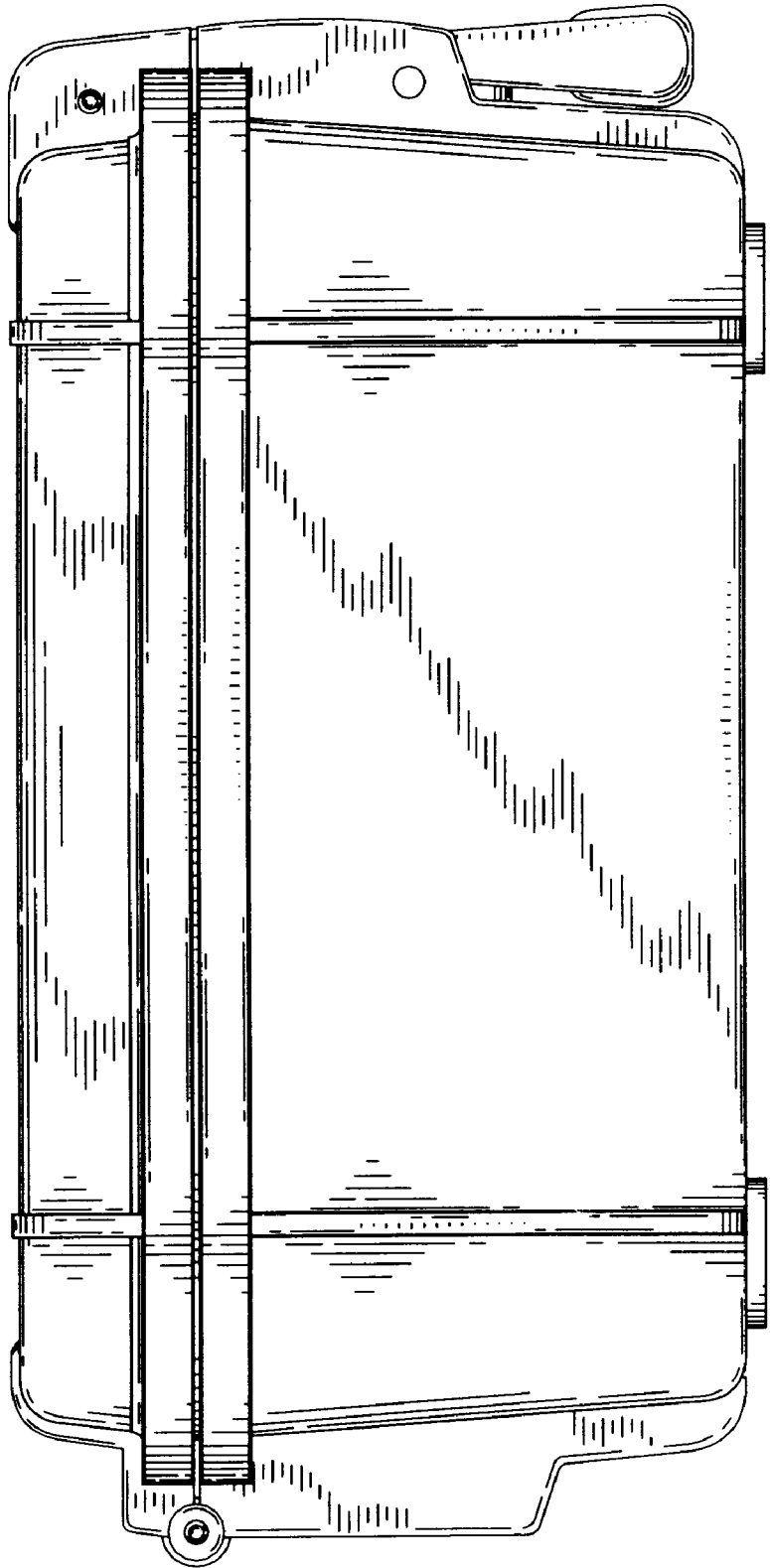

Fig. 3

Fig. 4



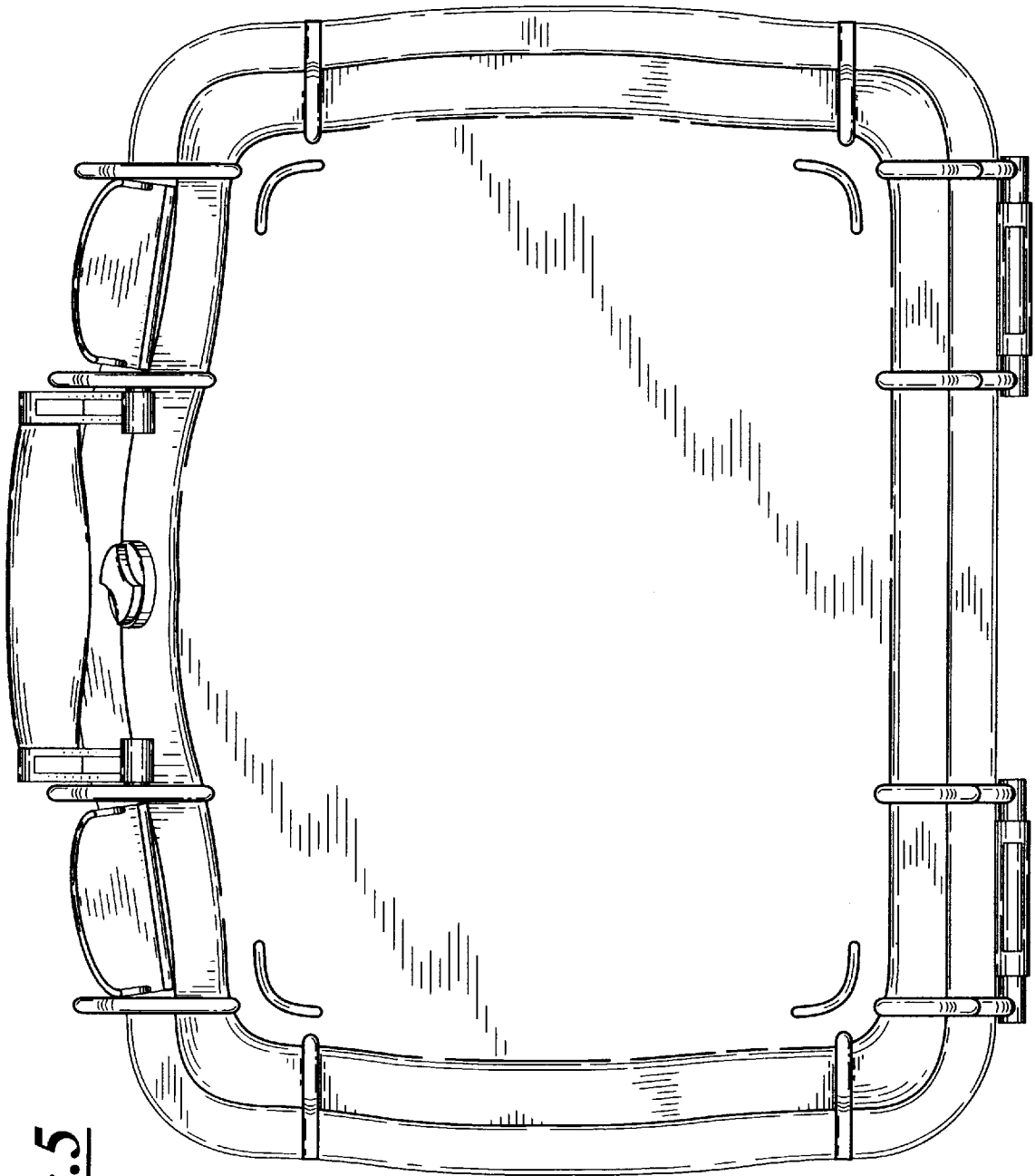

Fig. 5

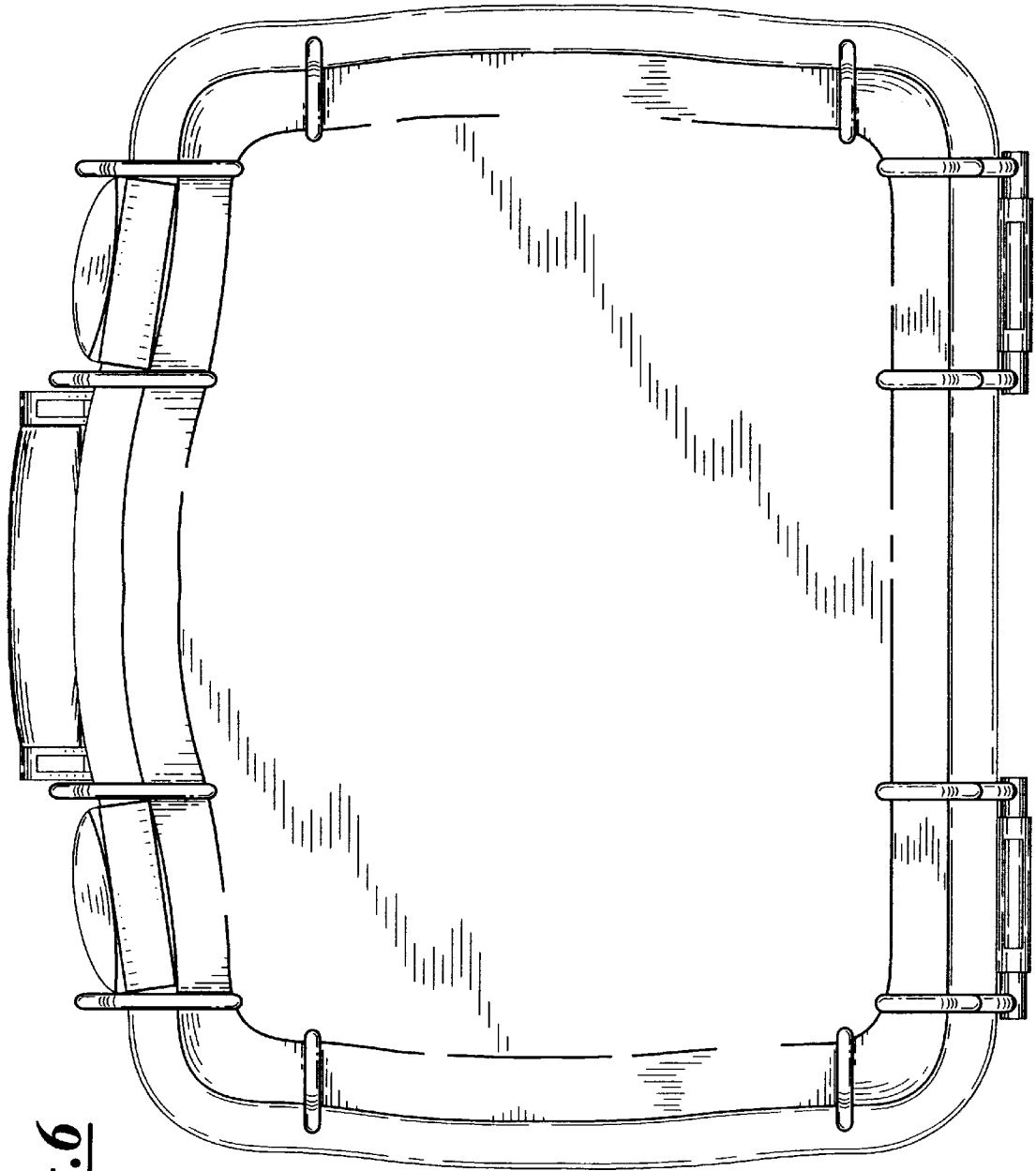

Fig. 6