



(11) **EP 3 742 064 B1**

(12) **EUROPEAN PATENT SPECIFICATION**

(45) Date of publication and mention of the grant of the patent:

16.03.2022 Bulletin 2022/11

(21) Application number: **19757445.2**

(22) Date of filing: **10.01.2019**

(51) International Patent Classification (IPC):

F24F 11/86 ^(2018.01) **F24F 11/88** ^(2018.01)
F25B 1/00 ^(2006.01) **F25B 13/00** ^(2006.01)
F24F 140/00 ^(2018.01) **F24F 3/06** ^(2006.01)
F24F 140/50 ^(2018.01) **F24F 11/48** ^(2018.01)

(52) Cooperative Patent Classification (CPC):

F24F 3/065; F24F 11/48; F24F 11/86; F25B 1/00; F25B 13/00; F24F 2140/50

(86) International application number:

PCT/JP2019/000444

(87) International publication number:

WO 2019/163317 (29.08.2019 Gazette 2019/35)

(54) **AIR CONDITIONER**

KLIMAANLAGE

CLIMATISEUR

(84) Designated Contracting States:

AL AT BE BG CH CY CZ DE DK EE ES FI FR GB GR HR HU IE IS IT LI LT LU LV MC MK MT NL NO PL PT RO RS SE SI SK SM TR

(30) Priority: **23.02.2018 JP 2018031167**

(43) Date of publication of application:

25.11.2020 Bulletin 2020/48

(73) Proprietor: **DAIKIN INDUSTRIES, LTD.**

Osaka 530-8323 (JP)

(72) Inventors:

- **TSUTSUMI, Tomohiko**
Osaka-shi, Osaka 530-8323 (JP)

• **FUJIOKA, Yuuki**

Osaka-shi, Osaka 530-8323 (JP)

(74) Representative: **Hoffmann Eitle**

Patent- und Rechtsanwälte PartmbB
Arabellastraße 30
81925 München (DE)

(56) References cited:

EP-A1- 1 953 477 EP-A1- 2 772 703
EP-A1- 3 067 636 JP-A- H09 145 130
JP-A- 2001 248 877

EP 3 742 064 B1

Note: Within nine months of the publication of the mention of the grant of the European patent in the European Patent Bulletin, any person may give notice to the European Patent Office of opposition to that patent, in accordance with the Implementing Regulations. Notice of opposition shall not be deemed to have been filed until the opposition fee has been paid. (Art. 99(1) European Patent Convention).

Description

TECHNICAL FIELD

[0001] The present disclosure relates to air conditioners.

BACKGROUND ART

[0002] Some conventional air conditioners control, when an outdoor unit is insufficient in air conditioning capacity, the capacity of each indoor unit based on priorities to put a limit on the flow rate of refrigerant supplied to a lower priority indoor unit (for example, refer to JP H8-271017 A (Patent Literature 1)).

CITATION LIST

PATENT LITERATURE

[0003] Patent Literature 1: JP H8-271017 A EP 3 067 636 A1 discloses features falling under the preamble of claim 1. EP 1 953 477 A1 and EP 2 772 703 A1 are further prior art.

SUMMARY OF INVENTION

TECHNICAL PROBLEMS

[0004] Further, such conventional air conditioners maximize, when there is a request for powerful operation from an indoor unit, a capacity request for the indoor unit and lower a capacity request for other lower priority indoor units; however, it takes time to reach a target temperature from the room temperature when the indoor unit is put into operation from an out-of-operation state, and thus quick cooling performance and quick heating performance are not high enough.

[0005] The present disclosure proposes an air conditioner having higher quick cooling performance and/or quick heating performance.

SOLUTIONS TO PROBLEMS

[0006] The invention is defined by claim 1. Preferred embodiments are defined in the dependent claims.

[0007] An air conditioner according to the present invention includes an outdoor unit, and a plurality of indoor units connected to the outdoor unit.

[0008] At least one of the plurality of indoor units connected to the outdoor unit is a low-capacity indoor unit lower in capacity than the other indoor units, characterized in that

the low-capacity indoor unit is configured such that when the low-capacity indoor unit is put in operation, a) a normal operation in which a capacity request for the low-capacity indoor unit is determined based on a target set temperature and an indoor temperature or b) a powerful

operation in which the low capacity indoor unit has a capacity higher than a maximum capacity in the normal operation, is performed, and when the powerful operation is performed,

a compressor of the outdoor unit is started at a rotational speed higher than a maximum rotational speed applied at start of the normal operation.

[0009] According to the present invention, in order to put the low-capacity indoor unit into powerful operation with a capacity higher than the maximum capacity in normal operation, the compressor of the outdoor unit is put into operation at a rotational speed higher than the maximum rotational speed applied at the start of normal operation, making it possible to increase quick cooling performance and/or quick heating performance.

[0010] Further, in the air conditioner according to one aspect of the present invention, the outdoor unit has a preheating operation capability of preheating the compressor while the outdoor unit is out of operation.

[0011] According to the above-described embodiment, the preheating operation capability of the outdoor unit makes it possible to preheat the compressor while the outdoor unit is out of operation, so that, even when the compressor of the outdoor unit is put into operation, for powerful operation, at a rotational speed higher than the maximum rotational speed applied at the start of normal operation, it is possible to prevent the compressor from running out of oil.

[0012] Further, in the air conditioner according to one aspect of the present invention, the low-capacity indoor unit takes precedence in capacity over the other indoor units during the powerful operation.

[0013] According to the present invention, while the low-capacity indoor unit and the other indoor units are in operation, the low-capacity indoor unit takes precedence in capacity over the other indoor units during the powerful operation, thereby allowing the low-capacity indoor unit to quickly cool or heat a small space in which the low-capacity indoor unit is installed.

[0014] Further, in the air conditioner according to one aspect of the present invention, the low-capacity indoor unit has a rated cooling capacity of less than 2,2 kW.

[0015] According to said aspect of the present invention, since the rated cooling capacity is less than 2,2 kW, it is suitable for air conditioning in a small space such as a washroom or a kitchen.

BRIEF DESCRIPTION OF DRAWINGS

[0016]

FIG. 1 is a structure diagram of a multi-type air conditioner including a low-capacity indoor unit according to a first embodiment of the present invention. FIG. 2 is a block diagram of an outdoor control device of an outdoor unit of the multi-type air conditioner. FIG. 3 is an external view of the low-capacity indoor

unit viewed from obliquely below.

FIG. 4 is a block diagram of an indoor control device of the low-capacity indoor unit.

FIG. 5 is a flow chart showing an operation of the multi-type air conditioner.

FIG. 6 is a graph showing changes in indoor temperature while the low-capacity indoor unit of the multi-type air conditioner is in powerful heating operation.

FIG. 7 is a structure diagram of a multi-type air conditioner including a low-capacity indoor unit according to a second embodiment of the present invention.

DESCRIPTION OF EMBODIMENTS

[0017] Embodiments will be described below.

[First embodiment]

[0018] FIG. 1 is a structure diagram of a multi-type air conditioner including a low-capacity indoor unit according to a first embodiment of the present invention.

[0019] The multi-type air conditioner according to the first embodiment includes, as shown in FIG. 1, an indoor unit 20A including an indoor heat exchanger 4A and an indoor fan 5A, an indoor unit 20B including an indoor heat exchanger 4B and an indoor fan 5B, a low-capacity indoor unit 20C including an indoor heat exchanger 4C and an indoor fan 5C, and an outdoor unit 10 connected to the indoor units 20A, 20B and the low-capacity indoor unit 20C via refrigerant pipes.

[0020] The outdoor unit 10 is compatible with a multi-type air conditioner in which a plurality of indoor units are connectable to an outdoor unit, and the low-capacity indoor unit 20C is capable of operating as an indoor unit of the multi-type air conditioner.

[0021] In FIG. 1, 1 denotes a compressor, 2 denotes a four-way switching valve having one end connected to a discharge side of the compressor 1, 3 denotes an outdoor heat exchanger having one end connected to the other end of the four-way switching valve 2, EVA, EVB, EVC denote electrically powered expansion valves each having one end connected to the other end of the outdoor heat exchanger 3, 4A, 4B, 4C denote the indoor heat exchangers each having one end connected to the other end of a corresponding one of the electrically powered expansion valves EVA, EVB, EVC, and 6 denotes an accumulator having one end connected to the other ends of the indoor heat exchangers 4A, 4B, 4C via the four-way switching valve 2 and having the other end connected to an intake side of the compressor 1. The indoor fans 5A, 5B, 5C are arranged near the indoor heat exchangers 4A, 4B, 4C, respectively.

[0022] Further, the electrically powered expansion valves EVA, EVB, EVC each have the other end connected to a corresponding one of a plurality of refrigerant pipe connection parts 7A, 7B, 7C, and the indoor heat exchangers 4A, 4B, 4C each have one end connected

to a corresponding one of the plurality of refrigerant pipe connection parts 7A, 7B, 7C via a connection pipe (refrigerant pipe). Further, the indoor heat exchangers 4A, 4B, 4C have the other ends connected to a plurality of refrigerant pipe connection parts 8A, 8B, 8C, respectively, via respective connection pipes (refrigerant pipes).

[0023] The compressor 1, the four-way switching valve 2, the outdoor heat exchanger 3, the electrically powered expansion valves EVA, EVB, EVC, the indoor heat exchangers 4A, 4B, 4C, and the accumulator 6 constitute a refrigerant circuit. This refrigerant circuit is filled with a slightly flammable R32 refrigerant.

[0024] Further, provided on the discharge side of the compressor 1 is a discharge pipe temperature sensor 11. Further, the outdoor heat exchanger 3 is provided with an outdoor heat exchanger temperature sensor 12 that detects an outdoor heat exchanger temperature, and, in the vicinity of the outdoor heat exchanger 3, an outdoor temperature sensor 13 that detects an outdoor temperature is provided.

[0025] Further, the indoor heat exchanger 4A is provided with an indoor heat exchanger temperature sensor 15A that detects an indoor heat exchanger temperature, and, in the vicinity of the indoor heat exchanger 4A, an indoor temperature sensor 16A that detects an indoor temperature is provided. Further, the indoor heat exchanger 4B is provided with an indoor heat exchanger temperature sensor 15B that detects an indoor heat exchanger temperature, and, in the vicinity of the indoor heat exchanger 4B, an indoor temperature sensor 16B that detects an indoor temperature is provided. Further, the indoor heat exchanger 4C is provided with an indoor heat exchanger temperature sensor 15C that detects an indoor heat exchanger temperature, and, in the vicinity of the indoor heat exchanger 4C, an indoor temperature sensor 16C that detects an indoor temperature is provided.

[0026] The outdoor unit 10 includes an outdoor control device 100 including a microcomputer, an input-output circuit, and the like. The outdoor control device 100 includes an operation control unit 100a that controls the compressor 1, the electrically powered expansion valves EVA, EVB, EVC, and the like, and a communication unit 100b. Further, the indoor units 20A, 20B each include an indoor control device (not shown), and the low-capacity indoor unit 20C includes an indoor control device 200 shown in FIG. 2.

[0027] The indoor control devices of the indoor units 20A, 20B and the indoor control device 200 of the low-capacity indoor unit 20C communicate with the outdoor control device 100 of the outdoor unit 10 over a communication line (not shown) so as to cause the outdoor control device 100, the indoor control devices of the indoor units 20A, 20B, and the indoor control device 200 of the low-capacity indoor unit 20C to operate in cooperation with each other as the multi-type air conditioner.

[0028] When the indoor units 20A, 20B and the low-capacity indoor unit 20C are put into cooling operation in

the multi-type air conditioner, the four-way switching valve 2 is switched to a position represented by a dotted line, and then the compressor 1 is put into operation. Then, each of the electrically powered expansion valves EVA, EVB, EVC is opened to a predetermined opening degree. Then, a high-temperature and high-pressure gas refrigerant discharged from the compressor 1 exchanges heat with outdoor air in the outdoor heat exchanger 3 with the help of an outdoor fan (not shown) in operation to be condensed to a liquid refrigerant. Next, a liquid refrigerant from the indoor heat exchangers 4A, 4B, 4C is decompressed by the electrically powered expansion valves EVA, EVB, EVC, exchanges heat with indoor air in the indoor heat exchangers 4A, 4B, 4C with the help of the indoor fans 5A, 5B, 5C in operation to be evaporated to become a gas refrigerant, and then returns to the intake side of the compressor 1.

[0029] Here, the indoor units 20A, 20B have a rated cooling capacity of 2.2 kW, and the low-capacity indoor unit 20C has a rated cooling capacity of 0.8 kW. That is, the low-capacity indoor unit 20C is lower in capacity than the indoor units 20A, 20B and is used for heating and cooling a small space such as a washroom or a kitchen.

[0030] On the other hand, when the indoor units 20A, 20B and the low-capacity indoor unit 20C are put into heating operation, the four-way switching valve 2 is switched to a position represented by a solid line, and then the compressor 1 is put into operation. Then, each of the electrically powered expansion valves EVA, EVB, EVC is opened to a predetermined opening degree. Then, a high-temperature and high-pressure gas refrigerant discharged from the compressor 1 exchanges heat with indoor air in the indoor heat exchangers 4A, 4B, 4C with the help of the indoor fans 5A, 5B, 5C in operation to be condensed to a liquid refrigerant. Next, a liquid refrigerant from the indoor heat exchangers 4A, 4B, 4C is decompressed by the electrically powered expansion valves EVA, EVB, EVC, exchanges heat with outdoor air in the outdoor heat exchanger 3 with the help of the outdoor fan (not shown) in operation to be evaporated to become a gas refrigerant, and then returns to the intake side of the compressor 1.

[0031] FIG. 2 is a block diagram of the outdoor control device 100 of the outdoor unit 10 of the multi-type air conditioner.

[0032] As shown in FIG. 2, the outdoor unit 10 includes the outdoor control device 100 including the microcomputer, the input-output circuit, and the like. Connected to the outdoor control device 100 are the discharge pipe temperature sensor 11, the outdoor heat exchanger temperature sensor 12, the outdoor temperature sensor 13, the compressor 1, the four-way switching valve 2, a fan motor 14, and the electrically powered expansion valves EVA, EVB, EVC. Further, the outdoor control device 100 further includes the operation control unit 100a and the communication unit 100b.

[0033] The operation control unit 100a controls the compressor 1, the electrically powered expansion valves

EVA, EVB, EVC, and the like based on detection signals from the discharge pipe temperature sensor 11, the outdoor heat exchanger temperature sensor 12, and the outdoor temperature sensor 13.

[0034] The communication unit 100b communicates with the indoor control device 200 (shown in FIG. 4) of the low-capacity indoor unit 20C connected to the outdoor unit 10 via a communication unit 200b.

[0035] FIG. 3 is an external view of the low-capacity indoor unit 20C viewed from obliquely below. This indoor unit 20C is designed to be embedded in a ceiling.

[0036] As shown in FIG. 3, the low-capacity indoor unit 20C includes a casing main body 101, a panel 102 having a rectangular shape and mounted to a lower side of the casing main body 101, and a grille 103 detachably mounted to the panel 102.

[0037] The panel 102 has, on its one end in a longitudinal direction, a blow-out port 110 extending along a short side of the panel 102. The panel 102 further has a flap 120 pivotably mounted to the panel 102. In FIG. 3, the flap 120 closes the blow-out port 110.

[0038] A drain socket 107 is further provided protruding from a sidewall of the casing main body 101. The drain socket 107 is connected to an external drain hose (not shown). Pipe connection parts 105, 106 are further provided protruding from the sidewall of the casing main body 101. The pipe connection parts 105, 106 are each connected to a corresponding external refrigerant pipe (not shown).

[0039] Also, in FIG. 3, 108 denotes an electrical components unit, and 111 to 113 denote hanger fittings each protruding sideward from the casing main body 101.

[0040] FIG. 4 is a block diagram of the indoor control device 200 of the low-capacity indoor unit 20C.

[0041] As shown in FIG. 4, the low-capacity indoor unit 20C includes the indoor control device 200 including a microcomputer, an input-output circuit, and the like. Connected to the indoor control device 200 are the indoor heat exchanger temperature sensor 15C, the indoor temperature sensor 16C, a fan motor 21, a flap drive unit 22, and a display unit 23. The indoor control device 200 further includes an operation control unit 200a and the communication unit 200b.

[0042] The operation control unit 200a controls the fan motor 21, the flap drive unit 22, and the like based on detection signals from the indoor heat exchanger temperature sensor 15C and the indoor temperature sensor 16C.

[0043] The communication unit 200b communicates with the outdoor control device 100 (shown in FIG. 2) of the outdoor unit 10 connected to the low-capacity indoor unit 20C via the communication unit 100b.

[0044] FIG. 5 is a flow chart for describing the operation of the multi-type air conditioner.

55

<One room operation>

[0045] For example, in order to put the low-capacity

indoor unit 20C into normal heating operation and put the indoor units 20A, 20B out of operation, first, in step S1, the outdoor control device 100 of the outdoor unit 10 determines, in response to an operation command signal from the indoor control device 200 of the low-capacity indoor unit 20C, whether there is a request for powerful operation.

[0046] Then, when determining that there is no request for powerful operation, the outdoor control device 100 proceeds to step S2 to put the compressor 1 into operation at a maximum rotational speed A (for example, 55 Hz) applied at the start of normal operation.

[0047] Next, in step S3, the outdoor control device 100 and the indoor control device 200 perform normal heating operation control. Under this normal heating operation control, a capacity request ΔD for the low-capacity indoor unit 20C is determined based on a target set temperature and indoor temperature.

[0048] On the other hand, in order to put the low-capacity indoor unit 20C into powerful heating operation and put the indoor units 20A, 20B out of operation, first, in step S1, the outdoor control device 100 of the outdoor unit 10 determines that, in response to a signal from the indoor control device 200 of the low-capacity indoor unit 20C, there is a request for powerful operation, and then proceeds to step S4 to put the compressor 1 into operation at a rotational speed (for example, 70 Hz) higher than the maximum rotational speed A (for example, 55 Hz) applied at the start of normal operation.

[0049] Next, proceeding to step S5, the outdoor control device 100 of the outdoor unit 10 and the indoor control device 200 of the low-capacity indoor unit 20C perform powerful operation control by controlling the compressor 1 and the electrically powered expansion valves EVA to EVC and the indoor fan 5C. Under this powerful operation control, the capacity request ΔD for the low-capacity indoor unit 20C is maximized, and the indoor fan 5C is rotated at a rotational speed higher than the maximum rotational speed of the indoor fan in normal operation.

<Two room operation>

[0050] For example, in order to put the low-capacity indoor unit 20C and the indoor unit 20A into normal heating operation and put the indoor unit 20B out of operation, first, in step S1, when the outdoor control device 100 determines that there is no request for powerful operation, the outdoor control device 100 proceeds to step S2 to put the compressor 1 into operation at the maximum rotational speed A (for example, 55 Hz) applied at the start of normal operation.

[0051] Next, proceeding to step S3, the outdoor control device 100 of the outdoor unit 10, the indoor control device 200 of the low-capacity indoor unit 20C, and the indoor control device of the indoor unit 20A perform normal heating operation control. Under this normal heating operation control, the capacity request ΔD for the low-capacity indoor unit 20C and the indoor unit 20A is de-

termined based on the target set temperature and the indoor temperature.

[0052] On the other hand, in order to put the low-capacity indoor unit 20C into powerful heating operation, put the indoor unit 20A into normal heating operation, and put the indoor unit 20B out of operation, first, in step S1, the outdoor control device 100 of the outdoor unit 10 determines, in response to signals from the indoor control device 200 of the low-capacity indoor unit 20C and the indoor control device of the indoor unit 20A, whether there is a request for powerful operation.

[0053] Then, when determining that there is a request for powerful operation, the outdoor control device 100 proceeds to step S4 to put the compressor 1 into operation at a rotational speed (for example, 70 Hz) higher than the maximum rotational speed A (for example, 55 Hz) applied at the start of normal operation.

[0054] Next, proceeding to step S5, the outdoor control device 100 of the outdoor unit 10 and the indoor control device 200 of the low-capacity indoor unit 20C perform powerful operation control by controlling the compressor 1 and the electrically powered expansion valves EVA to EVC and the indoor fan 5C. Under this powerful operation control, the capacity request ΔD for the low-capacity indoor unit 20C is maximized, and the indoor fan 5C is rotated at a rotational speed higher than the maximum rotational speed of the indoor fan in normal operation. At this time, the capacity request ΔD for the indoor unit 20A that is put into normal heating operation is determined based on the target set temperature and the indoor temperature.

[0055] Here, when the indoor unit 20A is set as a priority room, the indoor control device of the indoor unit 20A also performs powerful operation control.

[0056] In this multi-type air conditioner, it is possible to set one of the plurality of indoor units as the priority room using a setting unit provided in the outdoor unit 10 at the time of installation.

<Three room operation>

[0057] In order to put the low-capacity indoor unit 20C into powerful heating operation and put the indoor units 20A, 20B into normal heating operation, the capacity request ΔD for the low-capacity indoor unit 20C is maximized, and the indoor fan 5C is rotated at a rotational speed higher than the maximum rotational speed of the indoor fan in normal operation. At this time, the capacity request ΔD for the indoor units 20A, 20B that are put into normal heating operation is determined based on the target set temperature and the indoor temperature.

[0058] Here, when the indoor unit 20A is set as the priority room, the indoor control device of the indoor unit 20A performs powerful operation control. Alternatively, when the indoor unit 20B is set as the priority room, the indoor control device of the indoor unit 20B performs powerful operation control.

[0059] FIG. 6 is a graph showing changes in room tem-

perature while the low-capacity indoor unit 20C is in powerful heating operation. Here, the room temperature is an average value of room temperatures at a plurality of measurement points in a room space measured. In FIG. 6, the horizontal axis represents time [min], and the vertical axis represents operating frequency [Hz] of the compressor 1, indoor temperature [°C], and rotational speed [1/10 rpm] of the indoor fan 5C.

[0060] As shown in FIG. 6, when starting powerful heating operation of the low-capacity indoor unit 20C, the capacity request ΔD for the low-capacity indoor unit 20C was maximized, the rotational speed of the indoor fan 5C was set to 1670 rpm, and the compressor 1 was put into operation at 70 Hz, resulting in the room temperature increasing from 10°C to 20°C within 10 minutes with the outside temperature of 2°C.

[0061] According to the multi-type air conditioner configured as described above, when starting powerful operation of the low-capacity indoor unit 20C with a capacity higher than the maximum capacity in normal operation, the compressor 1 of the outdoor unit 10 is put into operation at a rotational speed higher than the maximum rotational speed applied at the start of normal operation, making it possible to increase quick cooling performance and/or quick heating performance.

[0062] Further, while the low-capacity indoor unit 20C and the other indoor units 20A, 20B are in cooling operation or heating operation, the low-capacity indoor unit 20C takes precedence in capacity over the other indoor units 20A, 20B during powerful operation, thereby allowing the low-capacity indoor unit 20C to quickly cool or heat a small space in which the low-capacity indoor unit 20C is installed.

[0063] The operation in which the low-capacity indoor unit 20C takes precedence in capacity means an operation in which a thermo-off determination temperature applied when the other indoor units 0A, 20B reach the set temperature is set higher in cooling operation than in normal operation and is set lower in heating operation than in normal operation, so that the capacity concentrates on the low-capacity indoor unit 20C.

[0064] Further, since the low-capacity indoor unit 20C has a rated cooling capacity of 0,8 kW, the low-capacity indoor unit 20C is suitable for air conditioning in a small space such as a washroom or a kitchen.

[0065] Further, as for the multi-type air conditioner according to the first embodiment, the powerful operation control during heating operation has been described, but, for example, the same powerful operation control may be applied to cooling operation.

[Second embodiment]

[0066] FIG. 7 is a structure diagram of a multi-type air conditioner including a low-capacity indoor unit 20C according to a second embodiment of the present invention. The multi-type air conditioner according to the second embodiment is the same in structure as the multi-type air

conditioner according to the first embodiment, except for a preheating capability of preheating the compressor 1 of the outdoor unit 10.

[0067] The preheating capability is a capability of preheating the compressor 1 with a preheating unit 1a (a coil of a motor) provided in the compressor 1. Interrupting a phase of a motor drive signal from the outdoor control device 100 causes the coil itself to generate heat without rotating the motor. The preheating operation capability of the outdoor unit 10 preheats the compressor 1 when the outside temperature is equal to or lower than a predetermined temperature, for example.

[0068] According to the multi-type air conditioner configured as described above, the preheating operation capability of the outdoor unit 10 makes it possible to preheat the compressor 1 while the outdoor unit 10 is out of operation, so that, even when the compressor 1 of the outdoor unit 10 is put into operation, for powerful operation, at a rotational speed higher than the maximum rotational speed applied at the start of normal operation, preheating a lubricating oil in the compressor 1 to increase lubricating performance makes it possible to prevent the compressor 1 from running out of oil.

[0069] Note that, according to the second embodiment, the preheating unit 1a that preheats the compressor 1 is the coil of the motor in the compressor 1, or alternatively, the preheating unit may include a heater provided in the compressor 1 or the like.

[0070] According to the first and second embodiments, the multi-type air conditioner including the low-capacity indoor unit 20C and the other indoor units 20A, 20B has been described, but, for example, the present invention may be applied to a multi-type air conditioner including a plurality of low-capacity indoor units or a multi-type air conditioner including one other indoor unit, or three or more other indoor units.

[0071] The foregoing description concerns specific embodiments of the present invention; however, the present invention is not limited to the first and second embodiments, and various modifications and variations may be made within the scope of the appended claims.

REFERENCE SIGNS LIST

[0072]

1	compressor
1a	preheating unit
2	four-way switching valve
3	outdoor heat exchanger
4A, 4B, 4C	indoor heat exchanger
5A, 5B, 5C	indoor fan
6	accumulator
7A, 7B, 7C	refrigerant pipe connection part
8A, 8B, 8C	refrigerant pipe connection part
10	outdoor unit
11	discharge pipe temperature sensor
12	outdoor heat exchanger tempera-

	ture sensor	
13	outdoor temperature sensor	
15A, 15B, 15C	indoor heat exchanger temperature sensor	
16A, 16B, 16C	indoor temperature sensor	
20A, 20B	indoor unit	
20C	low-capacity indoor unit	
100	outdoor control device	
100a	operation control unit	
100b	communication unit	
200	indoor control device	
200a	operation control unit	
200b	communication unit	
EVA, EVB, EVC	electrically powered expansion valve	

Claims

1. An air conditioner comprising:
 - an outdoor unit (10) to which a plurality of indoor units (20A to 20C) are connected, wherein at least one of the plurality of indoor units (20A to 20C) connected to the outdoor unit (10) is a low-capacity indoor unit (20C) lower in capacity than the other indoor units (20A, 20B), **characterized in that** the low-capacity indoor unit (20C) is configured such that when the low-capacity indoor unit (20C) is put into operation, a) a normal operation in which a capacity request (ΔD) for the low-capacity indoor unit (20C) is determined based on a target set temperature and an indoor temperature or b) a powerful operation in which the low-capacity indoor unit (20) has a capacity higher than a maximum capacity in the normal operation, is performed, and when the powerful operation is performed, a compressor (1) of the outdoor unit (10) is started at a rotational speed higher than a maximum rotational speed applied at start of the normal operation.
2. The air conditioner according to claim 1, wherein the outdoor unit (10) has a preheating operation capability of preheating the compressor (1) while the outdoor unit (10) is out of operation.
3. The air conditioner according to claim 1 or 2, wherein the low-capacity indoor unit (20C) takes precedence in capacity over the other indoor units (20A, 20B) during the powerful operation.
4. The air conditioner according to any one of claims 1 to 3, wherein the low-capacity indoor unit (20C) has a rated cooling capacity of less than 2,2 kW.

Patentansprüche

1. Klimaanlage, umfassend:
 - eine Außeneinheit (10), an die eine Vielzahl von Innenraumeinheiten (20A bis 20C) angeschlossen sind, wobei mindestens eine der Vielzahl von Innenraumeinheiten (20A bis 20C), die an die Außeneinheit (10) angeschlossen sind, eine Niedrigleistungs-Innenraumeinheit (20C) ist, die in Bezug auf die Leistung niedriger ist als die anderen Innenraumeinheiten (20A, 20B), **dadurch gekennzeichnet, dass** die Niedrigleistungs-Innenraumeinheit (20C) so ausgelegt ist, dass, wenn die Niedrigleistungs-Innenraumeinheit (20C) in Betrieb genommen wird, a) ein normaler Betrieb, bei dem eine Leistungsanforderung (ΔD) für die Niedrigleistungs-Innenraumeinheit (20C) auf der Grundlage einer Zielsolltemperatur und einer Innenraumtemperatur bestimmt wird, oder b) ein leistungsstarker Betrieb, bei dem die Innenraumeinheit mit geringer Leistung (20) eine Leistung aufweist, die höher ist als eine maximale Leistung in dem normalen Betrieb, ausgeführt wird, und wenn der leistungsstarke Betrieb ausgeführt wird, ein Kompressor (1) der Außeneinheit (10) mit einer Rotationsgeschwindigkeit gestartet wird, die höher ist als eine maximale Rotationsgeschwindigkeit, die bei Start im normalen Betrieb angewendet wird.
2. Klimaanlage nach Anspruch 1, wobei die Außeneinheit (10) eine Vorwärmleistungsleistung zum Vorwärmen des Kompressor (1) aufweist, während die Außeneinheit (10) außer Betrieb ist.
3. Klimaanlage nach Anspruch 1 oder 2, wobei die Niedrigleistungs-Innenraumeinheit (20C) bei dem leistungsstarken Betrieb bezüglich der Leistung Vorrang vor den anderen Innenraumeinheiten (20A, 20B) hat.
4. Klimaanlage nach einem der Ansprüche 1 bis 3, wobei die Niedrigleistungs-Innenraumeinheit (20C) eine Nennkühlleistung von weniger als 2,2 kW aufweist.

Revendications

1. Climatiseur comprenant :
 - une unité extérieure (10) à laquelle est connectée une pluralité d'unités intérieures (20A à 20C), dans lequel au moins une de la pluralité des uni-

tés intérieures (20A à 20C) connectées à l'unité extérieure (10) est une unité intérieure basse performance (20C) avec une performance inférieure à celle des autres unités intérieures (20A, 20B), **caractérisé en ce que**

l'unité intérieure basse performance (20C) est configurée de telle sorte que lorsque l'unité intérieure basse performance (20C) est mise en service, a) un fonctionnement normal dans lequel une demande de performance (ΔD) pour l'unité intérieure basse performance (20C) est déterminée sur la base d'une température définie cible et d'une température intérieure ou b) un fonctionnement puissant dans lequel l'unité intérieure basse performance (20) présente une performance supérieure à une performance maximale en fonctionnement normal, est réalisé, et lorsque le fonctionnement puissant est réalisé, un compresseur (1) de l'unité extérieure (10) est démarré à une vitesse de rotation supérieure à une vitesse de rotation maximale appliquée au démarrage du fonctionnement normal.

2. Climatiseur selon la revendication 1, dans lequel l'unité extérieure (10) présente une capacité de fonctionnement de préchauffage pour préchauffer le compresseur (1) pendant que l'unité extérieure (10) est hors service.

3. Climatiseur selon la revendication 1 ou 2, dans lequel l'unité intérieure basse performance (10) devient prioritaire en termes de performance sur les autres unités intérieures (20A, 20B) pendant le fonctionnement puissant.

4. Climatiseur selon l'une quelconque des revendications 1 à 3, dans lequel l'unité intérieure basse performance (20C) présente une puissance nominale de refroidissement inférieure à 2,2 kW.

5

10

15

20

25

30

35

40

45

50

55

Fig.1

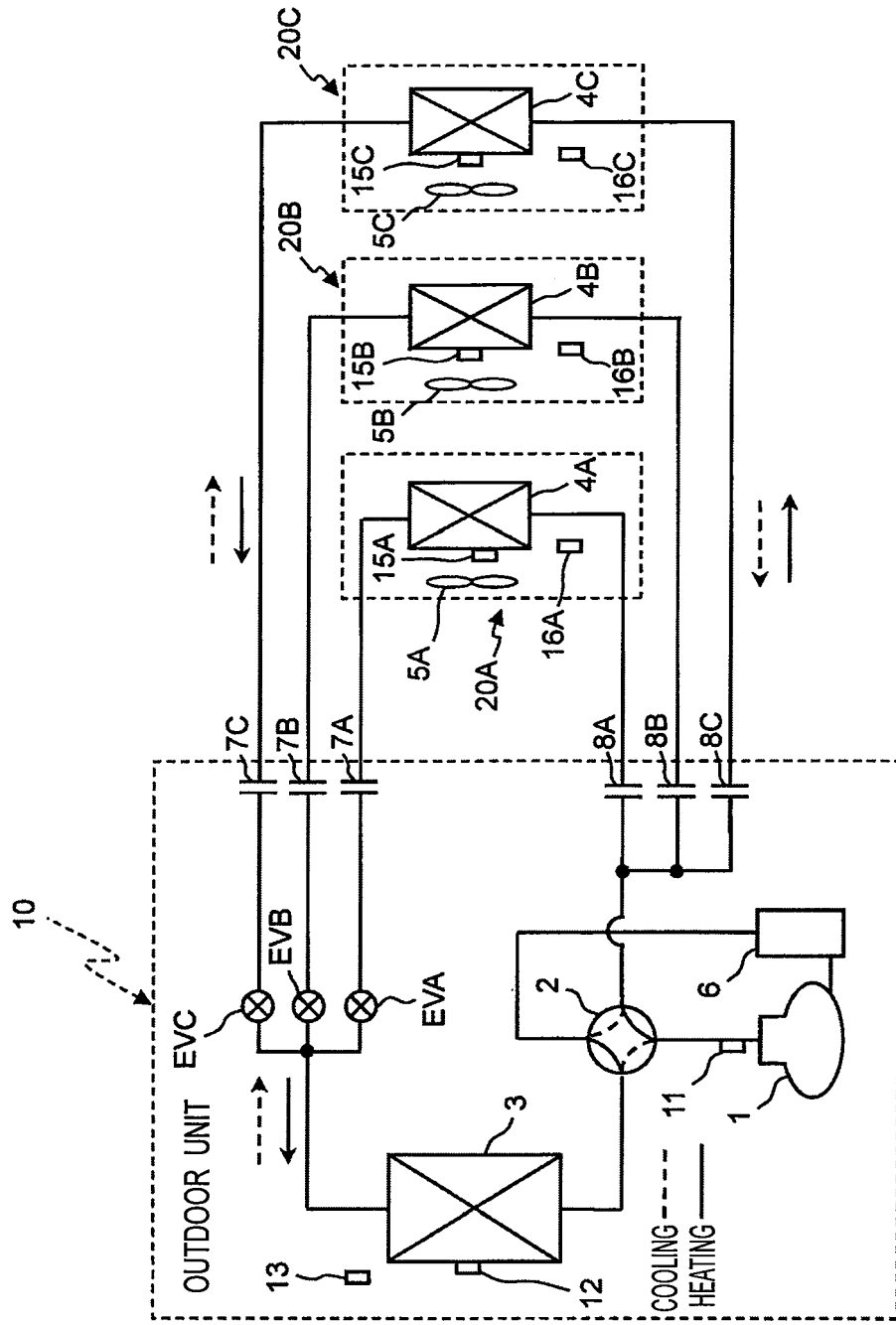

Fig.2

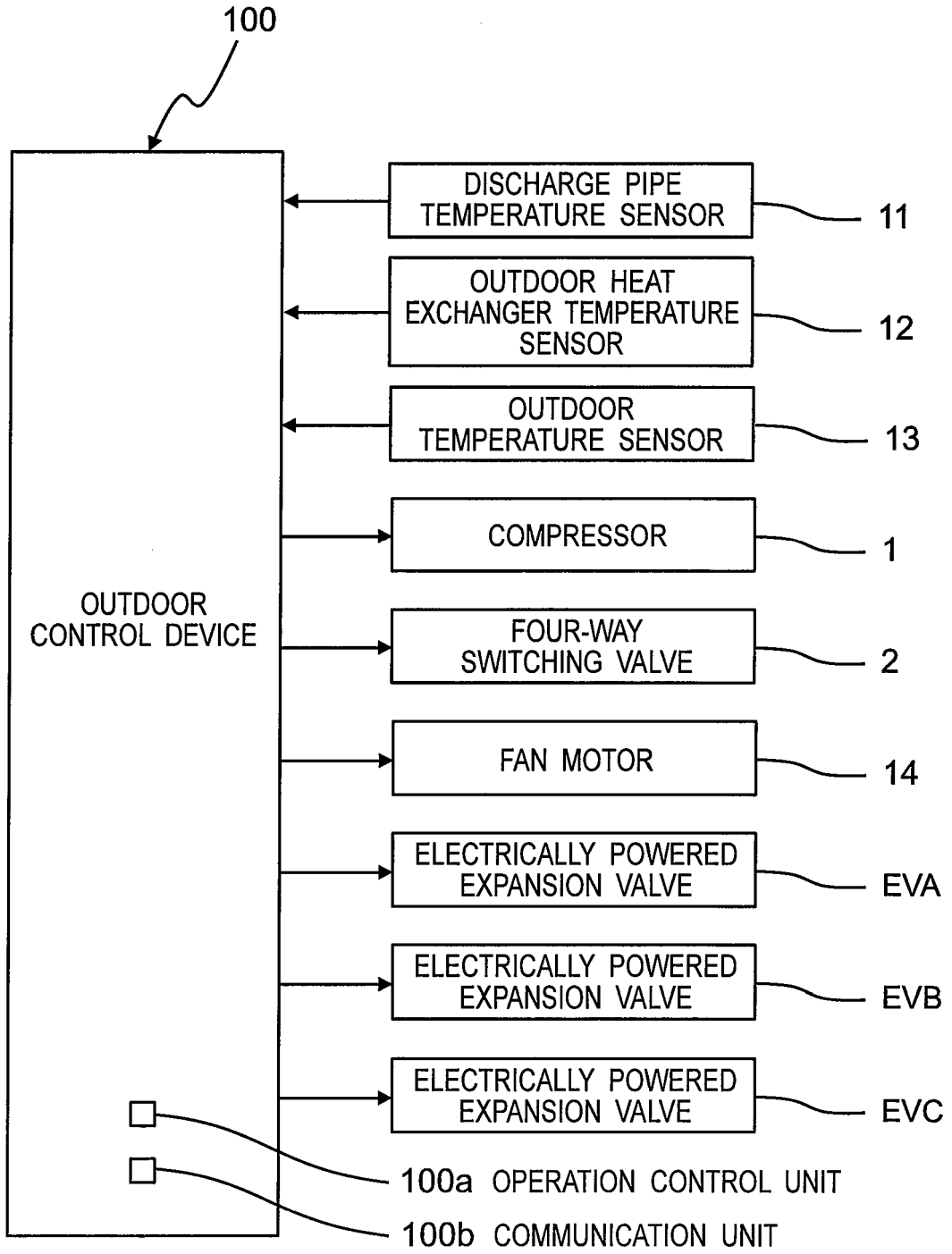

Fig. 3

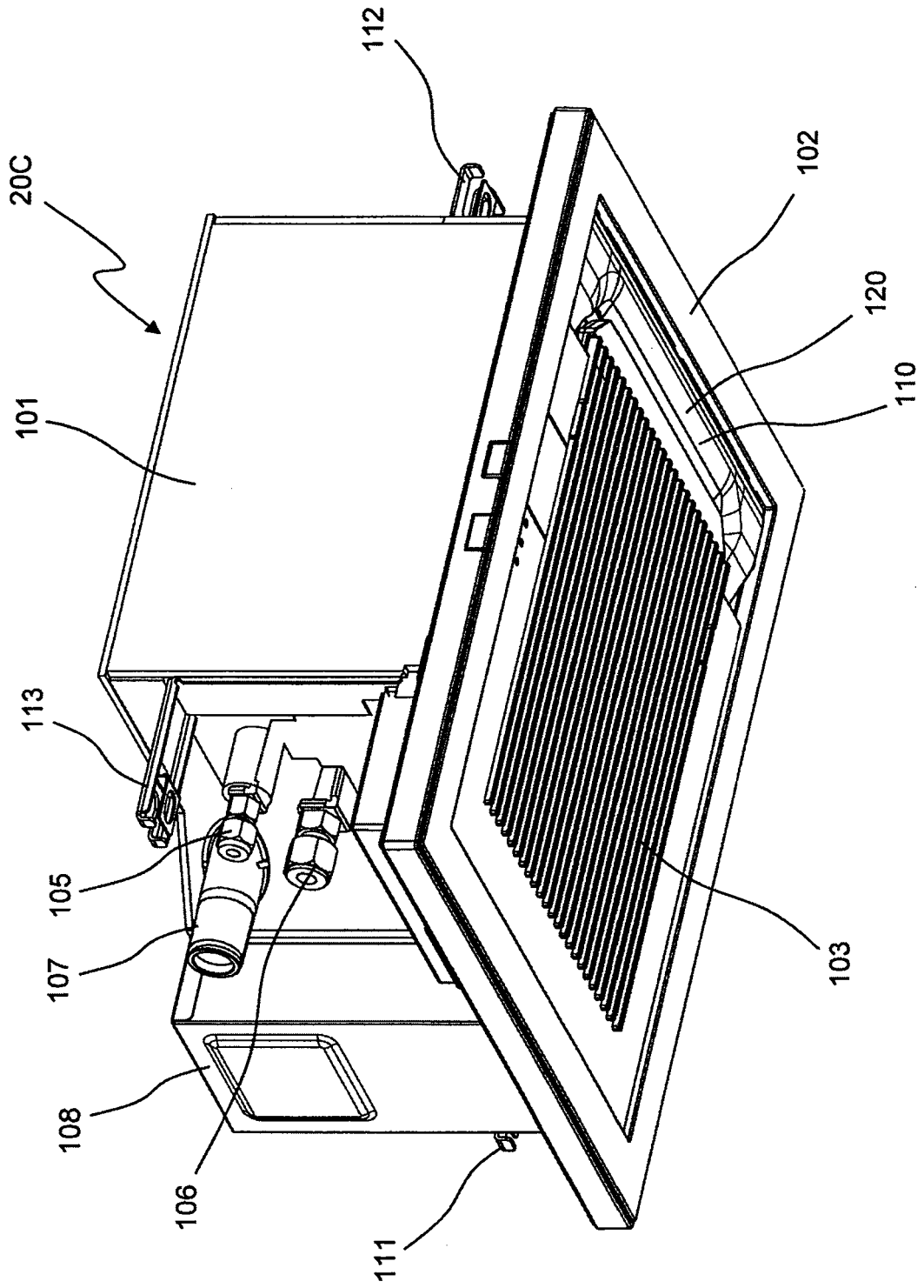

Fig.4

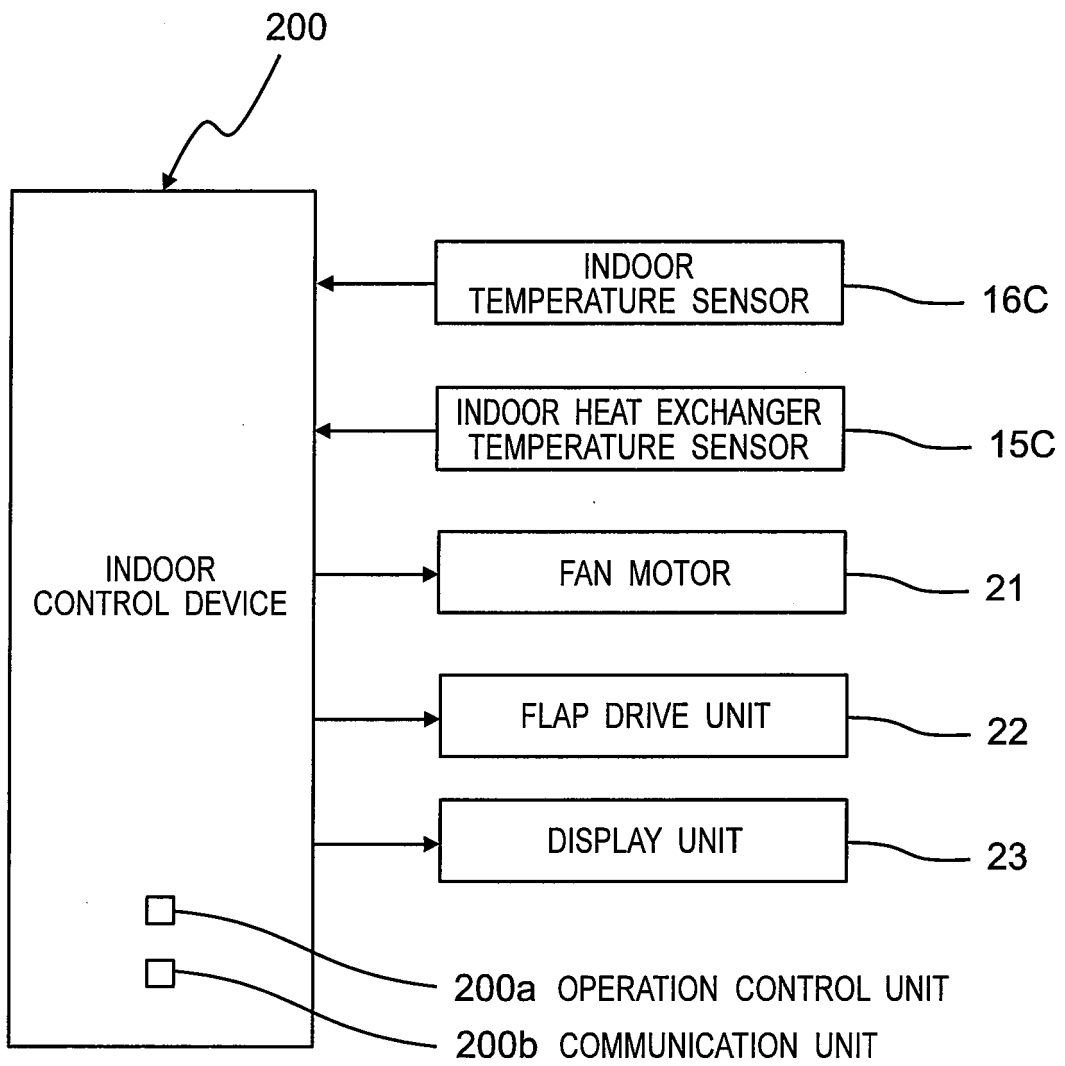
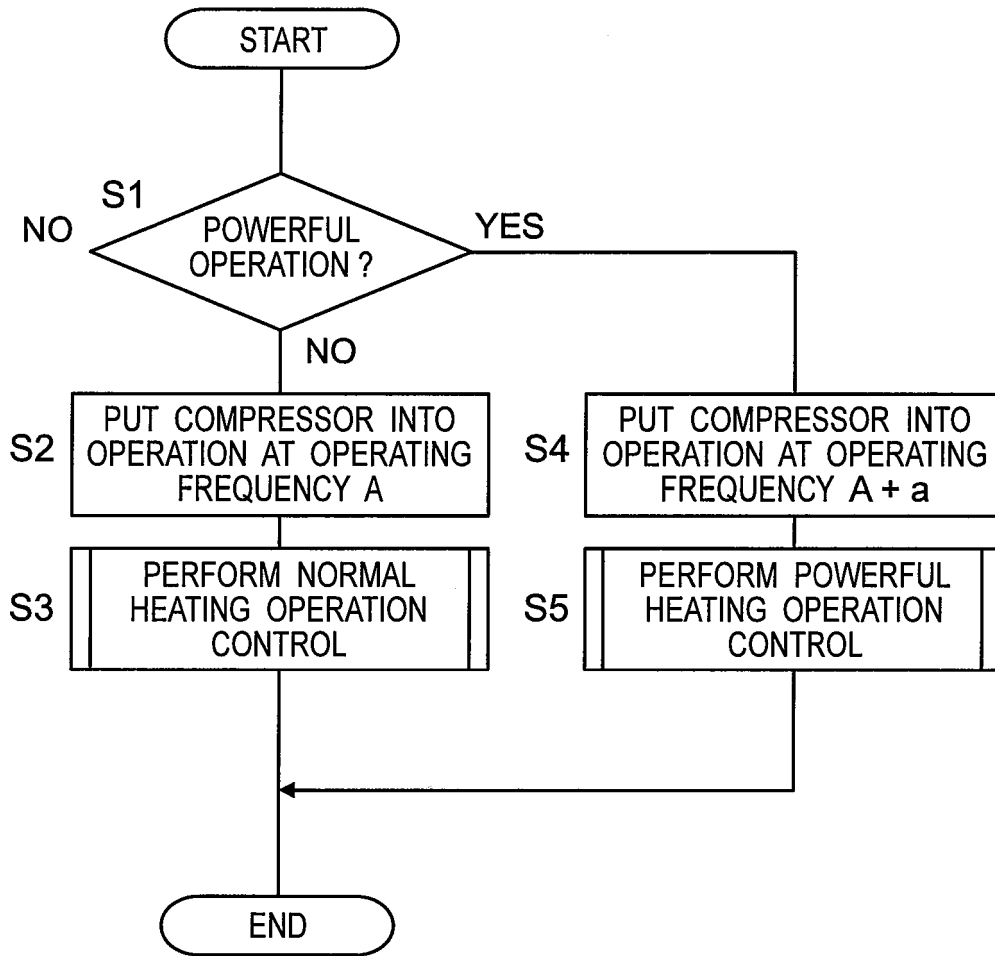

Fig.5



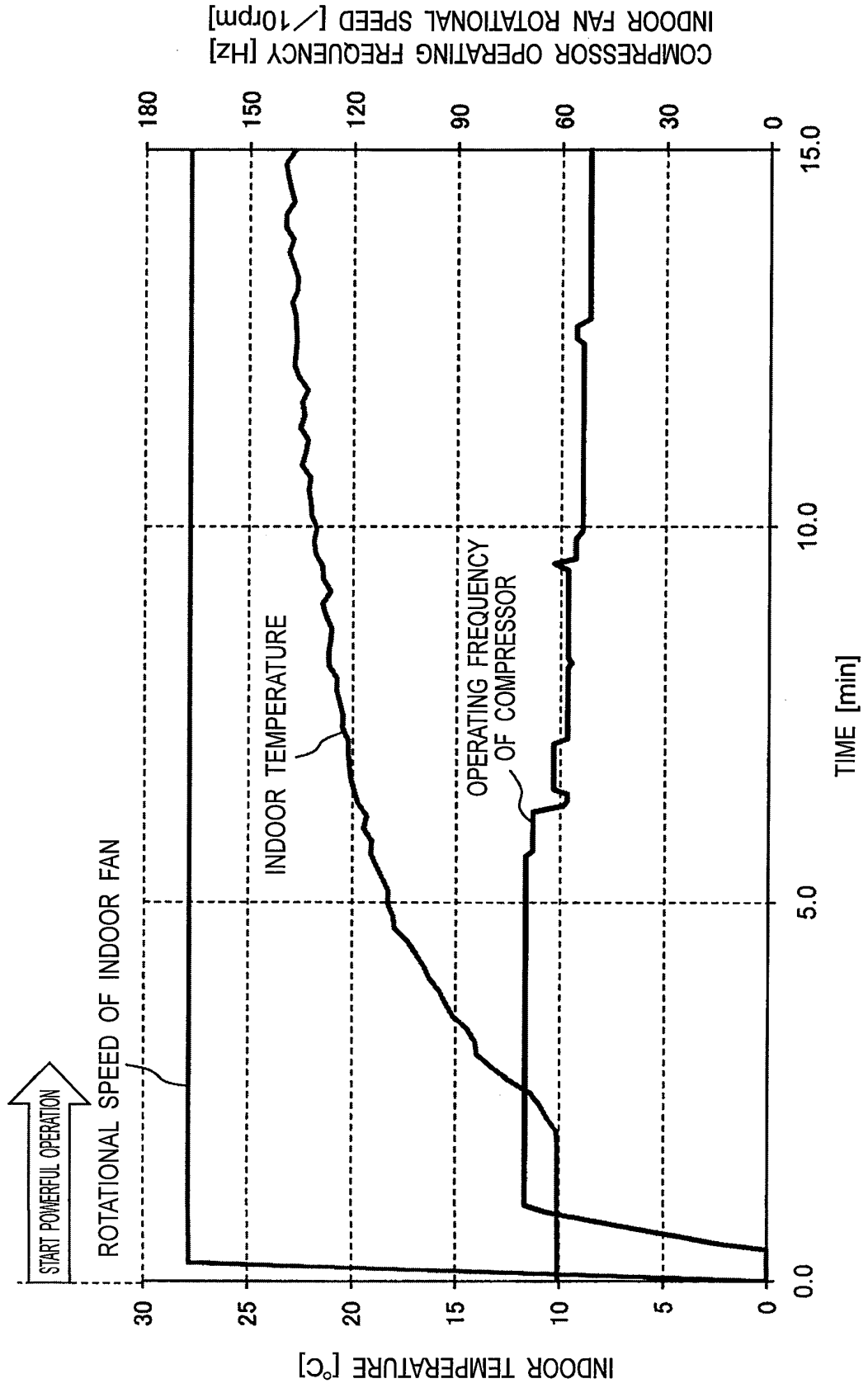
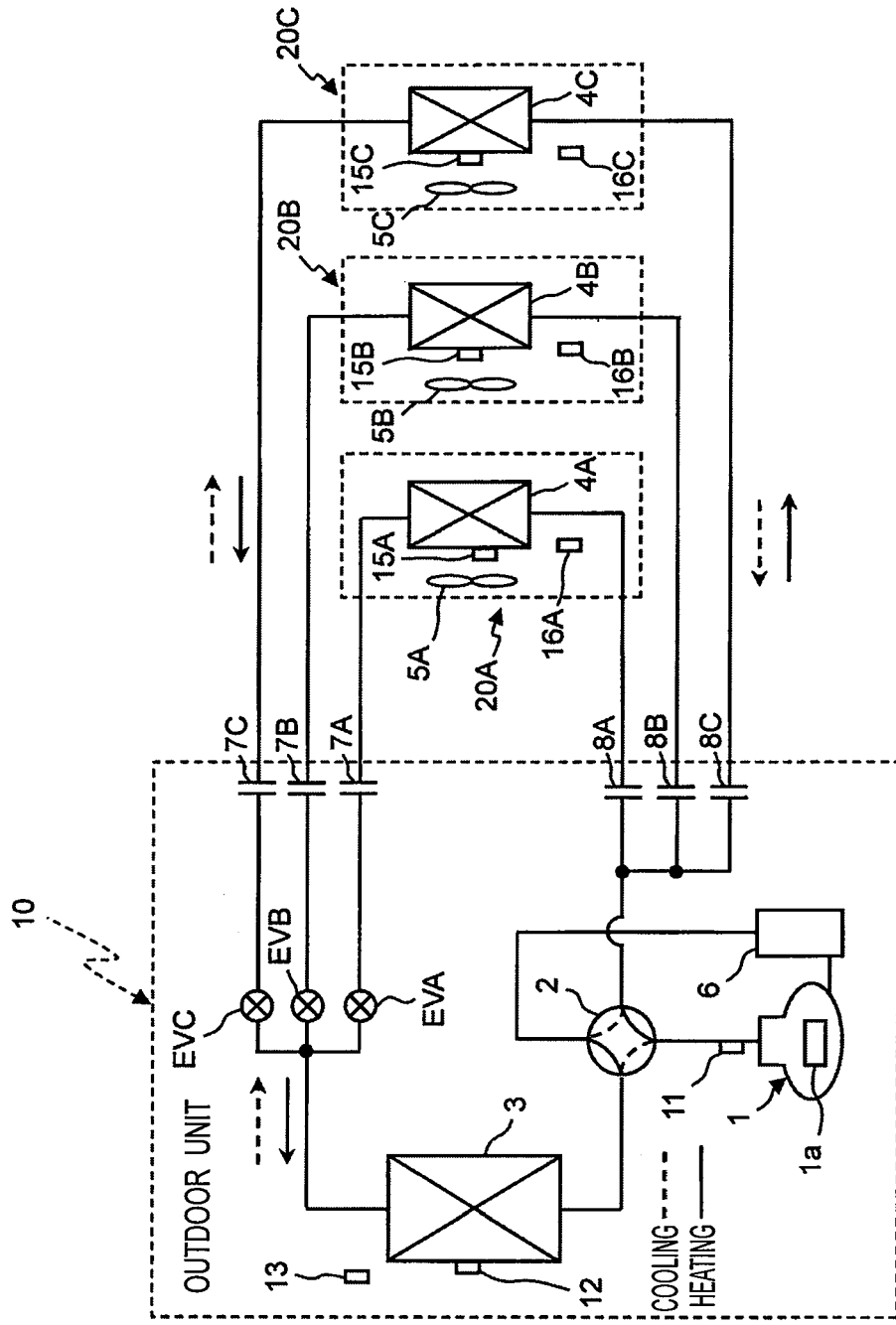

Fig.6

Fig.7



REFERENCES CITED IN THE DESCRIPTION

This list of references cited by the applicant is for the reader's convenience only. It does not form part of the European patent document. Even though great care has been taken in compiling the references, errors or omissions cannot be excluded and the EPO disclaims all liability in this regard.

Patent documents cited in the description

- JP H8271017 A [0002] [0003]
- EP 3067636 A1 [0003]
- EP 1953477 A1 [0003]
- EP 2772703 A1 [0003]