



US00D766434S

(12) **United States Design Patent** (10) **Patent No.:** **US D766,434 S**  
**DaCosta** (45) **Date of Patent:** **\*\* Sep. 13, 2016**

(54) **BONE PLATE**

(71) Applicant: **Paragon 28, Inc.**, Englewood, CO (US)

(72) Inventor: **Albert DaCosta**, Lone Tree, CO (US)

(73) Assignee: **PARAGON 28, INC.**, Englewood, CO (US)

(\*\*) Term: **14 Years**

(21) Appl. No.: **29/507,070**

(22) Filed: **Oct. 23, 2014**

(51) **LOC (10) Cl.** ..... **24-02**

(52) **U.S. Cl.**  
USPC ..... **D24/155**

(58) **Field of Classification Search**

USPC ..... D24/155-157  
CPC ..... A61B 17/8061; A61B 17/7059; A61B 17/8052; A61B 17/8605; A61B 17/8085; A61B 17/809; A61B 17/8014; A61B 17/8033; A61B 17/8004; A61B 17/888; A61B 17/842; A61B 17/8023; A61B 17/8009; A61B 17/86; A61B 17/17; A61B 17/39; A61B 17/8066; A61B 17/1671; A61B 17/1757; A61B 17/8071; A61B 17/176; A61B 2017/1782; A61B 2017/1775

See application file for complete search history.

(56) **References Cited**

U.S. PATENT DOCUMENTS

D520,637 S \* 5/2006 Kay ..... D24/155  
D648,027 S \* 11/2011 Vancellette ..... D24/155  
8,118,846 B2 \* 2/2012 Leither ..... A61B 17/8057  
606/280  
D699,351 S \* 2/2014 Podgorski ..... D24/155

\* cited by examiner

*Primary Examiner* — Charles Hanson

(74) *Attorney, Agent, or Firm* — John W. Boger

(57) **CLAIM**

The ornamental design for a bone plate, as shown and described.

**DESCRIPTION**

FIG. 1 is a top perspective view of a bone plate comprising the new design;  
FIG. 2 is a right elevational view of the design of FIG. 1;  
FIG. 3 is a left elevational view of the design of FIG. 1;  
FIG. 4 is a top view of the design of FIG. 1;  
FIG. 5 is a bottom view of the design of FIG. 1;  
FIG. 6 is a rear elevational view of the design of FIG. 1; and  
FIG. 7 is a front elevational view of the design of FIG. 1.  
The broken lines in the figures are directed to the environment and are for illustrative purposes only; the broken lines form no part of the claimed invention.

**1 Claim, 2 Drawing Sheets**

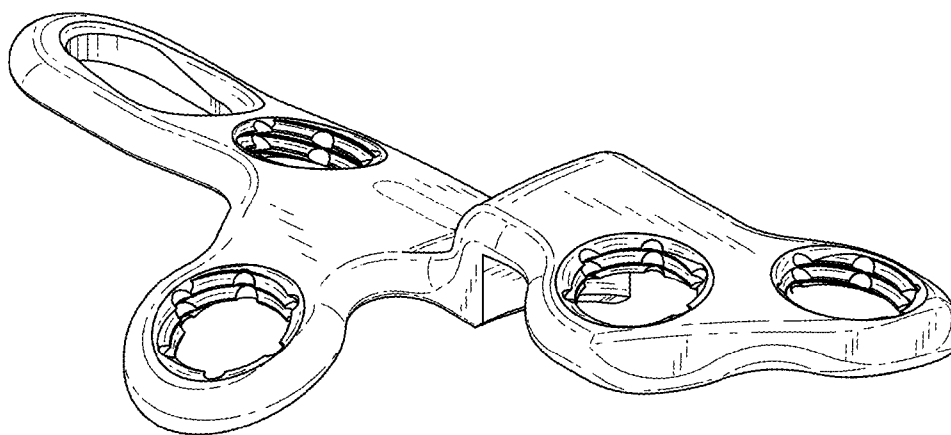

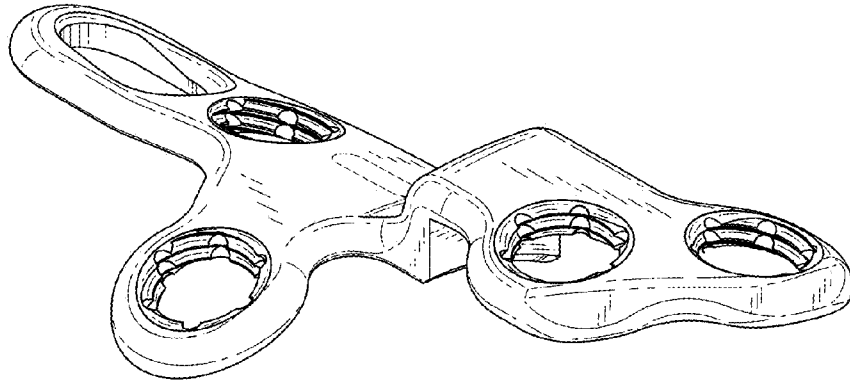

FIG. 1

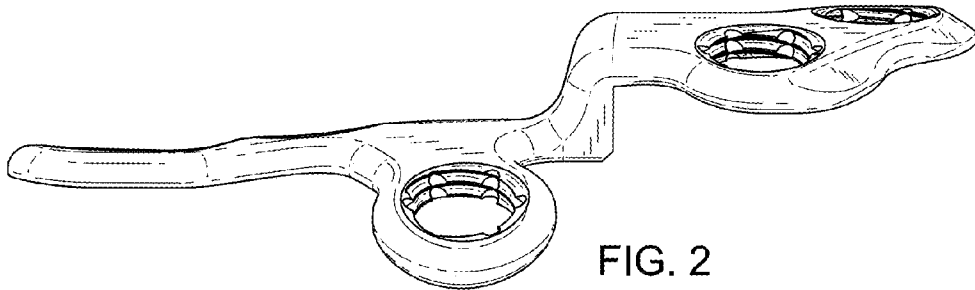

FIG. 2

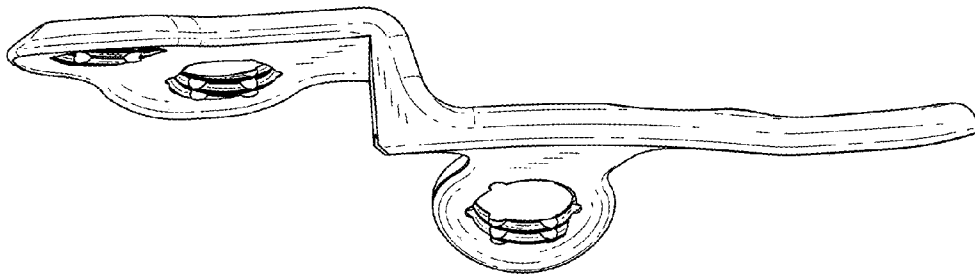

FIG. 3

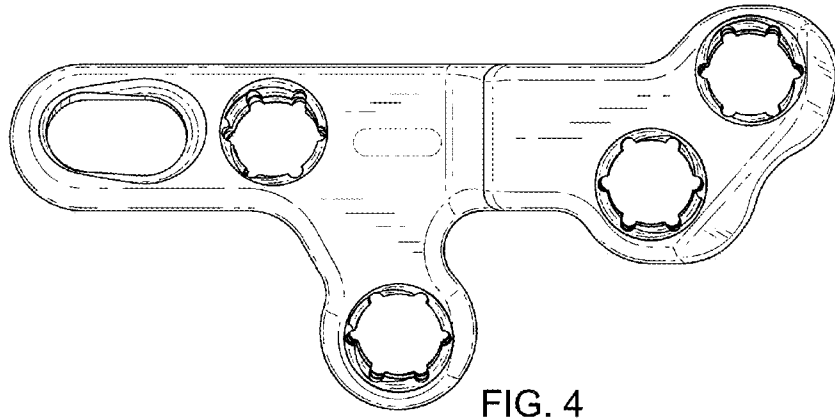

FIG. 4

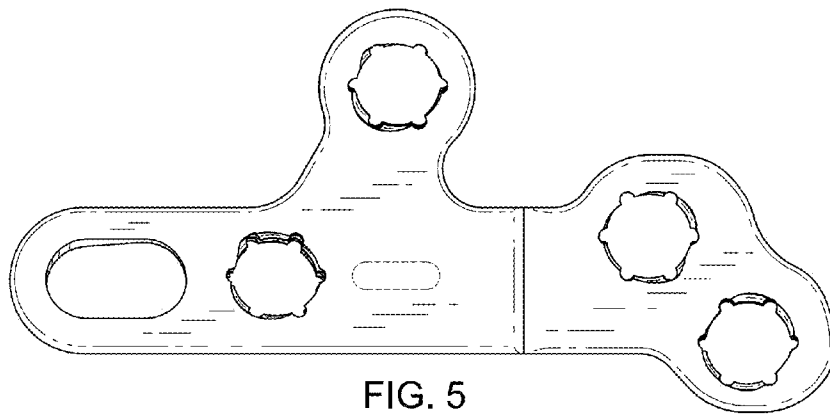

FIG. 5

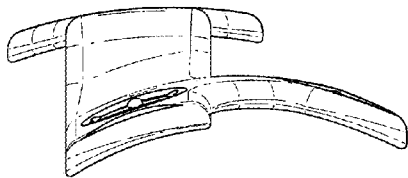

FIG. 6

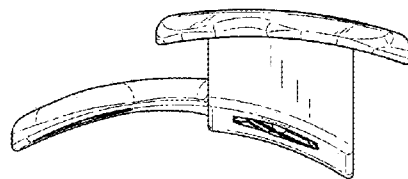

FIG. 7