

(19) World Intellectual Property Organization
International Bureau



(43) International Publication Date
23 December 2009 (23.12.2009)

(10) International Publication Number
WO 2009/155539 A2

(51) International Patent Classification:

B01D 53/78 (2006.01) *B01D 53/62* (2006.01)
B01D 53/14 (2006.01)

(21) International Application Number:

PCT/US2009/047999

(22) International Filing Date:

19 June 2009 (19.06.2009)

(25) Filing Language:

English

(26) Publication Language:

English

(30) Priority Data:

61/074,458 20 June 2008 (20.06.2008) US

(71) Applicant (for all designated States except US): **1446881 ALBERTA LTD.** [CA/CA]; 2401 TD Tower, Edmonton, AB T5J 2Z1 (CA).

(72) Inventors; and

(75) Inventors/Applicants (for US only): **KEITH, David** [US/CA]; 1320 Riverdale Ave Sw, Calgary, AB T2S 0Y8 (CA). **MAHMOUDKHANI, Maryam** [IR/CA]; 3500 Varsity Drive Nw, #801, Calgary, AB T2L 1Y3 (CA).

(74) Agent: **VASSILOVSKI, Edna**; FISH & RICHARDSON P.C., P.O. Box 1022, Minneapolis, MN 55440-1022 (US).

(81) Designated States (unless otherwise indicated, for every kind of national protection available): AE, AG, AL, AM, AO, AT, AU, AZ, BA, BB, BG, BH, BR, BW, BY, BZ,

CA, CH, CL, CN, CO, CR, CU, CZ, DE, DK, DM, DO, DZ, EC, EE, EG, ES, FI, GB, GD, GE, GH, GM, GT, HN, HR, HU, ID, IL, IN, IS, JP, KE, KG, KM, KN, KP, KR, KZ, LA, LC, LK, LR, LS, LT, LU, LY, MA, MD, ME, MG, MK, MN, MW, MX, MY, MZ, NA, NG, NI, NO, NZ, OM, PE, PG, PH, PL, PT, RO, RS, RU, SC, SD, SE, SG, SK, SL, SM, ST, SV, SY, TJ, TM, TN, TR, TT, TZ, UA, UG, US, UZ, VC, VN, ZA, ZM, ZW.

(84) Designated States (unless otherwise indicated, for every kind of regional protection available): ARIPO (BW, GH, GM, KE, LS, MW, MZ, NA, SD, SL, SZ, TZ, UG, ZM, ZW), Eurasian (AM, AZ, BY, KG, KZ, MD, RU, TJ, TM), European (AT, BE, BG, CH, CY, CZ, DE, DK, EE, ES, FI, FR, GB, GR, HR, HU, IE, IS, IT, LT, LU, LV, MC, MK, MT, NL, NO, PL, PT, RO, SE, SI, SK, TR), OAPI (BF, BJ, CF, CG, CI, CM, GA, GN, GQ, GW, ML, MR, NE, SN, TD, TG).

Declarations under Rule 4.17:

- as to applicant's entitlement to apply for and be granted a patent (Rule 4.17(ii))
- as to the applicant's entitlement to claim the priority of the earlier application (Rule 4.17(iii))

Published:

- without international search report and to be republished upon receipt of that report (Rule 48.2(g))



WO 2009/155539 A2

(54) Title: CARBON DIOXIDE CAPTURE

(57) Abstract: A method of carbon dioxide capture is disclosed. In a step (a) anhydrous sodium carbonate is separated from a first aqueous solution formed by reacting carbon dioxide and an aqueous solution of sodium hydroxide. In step (b) the anhydrous sodium carbonate is treated by causticization to generate carbon dioxide and sodium hydroxide. The first aqueous solution of step (a) is formed by scrubbing a gas containing carbon dioxide with an aqueous solution of sodium hydroxide.

CARBON DIOXIDE CAPTURE

CROSS-REFERENCE TO RELATED APPLICATIONS

[0001] This application claims priority to U.S. Provisional Application Serial No. 61/074,458, filed on June 20, 2008, which is incorporated by reference in its entirety herein.

TECHNICAL FIELD

[0002] This document relates to carbon dioxide capture systems and methods, including low-energy sodium hydroxide recovery for CO₂ capture from atmospheric air. This document relates to causticization processes which can be incorporated into carbon capture and storage strategies.

BACKGROUND

[0003] *Introduction*

[0004] To avoid dangerous climate change, the growth of atmospheric concentrations of carbon dioxide must be halted, and may have to be reduced. The concentration of carbon dioxide, the most important greenhouse gas, has increased from about 280 ppm in the preindustrial age to more than 385 ppm and it is now increasing by more than 2 ppm per year driven by global CO₂ emissions that are now increasing at more than 3.3% per year (Canadell et al., 2007).

[0005] Carbon capture and storage (CCS) technologies target CO₂ removal from large fixed-point sources such as power plants. Dispersed sources, however, emit more than half of global CO₂ emissions. Direct capture of CO₂ from ambient air, “air capture”, is one of the few methods capable of systematically managing dispersed emissions. Therefore, while air capture is more expensive than capture from large point sources it remains important as it will primarily compete with emission reductions from dispersed sources such as transportation which can be very expensive to mitigate.

[0006] *1.1 Air capture*

[0007] Carbon dioxide absorption from atmospheric air using alkaline solutions has been explored for half a century (Spector and Dodge 1946, Tepe and Dodge 1943). Large scale scrubbing of CO₂ from ambient air was first suggested by Lackner in the late 1990's (Lackner et al., 1999). In wet scrubbing techniques, CO₂ is absorbed into a solution of sodium hydroxide, NaOH, and is leaving behind an aqueous solution of sodium hydroxide and sodium carbonate, Na₂CO₃. For this process, the contactor, as the component of the system that provides the contacts between CO₂ and sodium hydroxide, has thus far been a point of contention. Large convective tower (Lackner et al., 1999), and packed scrubbing towers (Baciocchi et al., 2006 and Zeman, 2007) are the most commonly suggested contactor designs. A packed tower equipped with Sulzer Mellapak has been investigated by Baciocchi et al. (2006) to absorb CO₂ from air with an inlet concentration of 500 ppm to an outlet concentration of 250 ppm using a 2M NaOH solution.

[0008] An alternative strategy, suggested by Stolaroff et al. (2007), is to generate a fine spray of the absorbing solution for providing large surface to the air flow through an open tower. This strategy could have the potential to operate with a small pressure drop in air and avoids the capital cost of packing material. Stolaroff et al. (2007) studied the feasibility of a NaOH spray-based contactor by estimating the cost and energy requirement per unit CO₂ captured. Water loss, as a major concern in this design, was addressed and it was found that the water loss could be managed by adjusting of the NaOH concentration with temperature and humidity of air, i.e. the higher the concentration of sodium hydroxide, the lower the water loss, e.g. using ~7.2M NaOH, at 15°C and 65% relative humidity, eliminates water loss.

[0009] *1.2 Caustic recovery for air capture*

[0010] Conversion of sodium carbonate into sodium hydroxide, so-called causticization, is one of the oldest chemical processes. In Kraft Pulping for paper making, wood is digested using sodium hydroxide to liberate cellulose and produce pulp. The remaining solution, so-called "black liquor", consists of other, mainly organic materials originating from the wood, (e.g. lignin) along with sodium

carbonate. To convert sodium carbonate and recover NaOH the conventional causticization process using lime (Ca(OH)_2) has been used on a continuous basis for more than 80 years.

[0011] In air capture processes, the aqueous solution of sodium carbonate and concentrated sodium hydroxide must be converted to fresh sodium hydroxide and gaseous CO_2 to be used for disposal or fuels. To convert sodium carbonate to sodium hydroxide, and regenerate the reservoir solution, a conventional causticization technique using lime (Ca(OH)_2) has, thus far, been addressed (Baciacchi, et al., 2006, Stolaroff et al., 2007 and Zeman, 2007). In conventional chemical recovery, Na_2CO_3 is causticized with lime to form NaOH and lime mud (CaCO_3), reaction [1]. The conversion of Na_2CO_3 to NaOH and regeneration of lime is a series of liquid-solid reactions, reactions [1] to [3], i.e. all involved calcium compounds are solids.

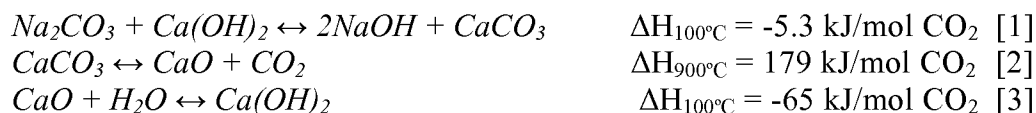

[0012] Conventional causticization would require ~ 170 kJ/mol CO_2 for drying and heating the reactant, CaCO_3 , to the reaction temperature and 179 kJ/mol CO_2 for reaction [2]. Comparing the high temperature energy required to regenerate NaOH using conventional causticization with the thermodynamic minimum required energy given by the enthalpy of the reaction for absorption of CO_2 from air into sodium hydroxide solution, it can be seen that the required energy for conventional causticization is far beyond the thermodynamic minimum, i.e. the enthalpy of the reaction for absorption of CO_2 from air into sodium hydroxide solution for a nominal 1 molar solution and at 298K and a pressure of 1 bar is -109.4 kJ/mol CO_2 which implies that to go from sodium carbonate to sodium hydroxide the thermodynamic minimum required energy is 109.4 kJ/mol CO_2 (Zeman and Lackner, 2004).

[0013] As a tool for air capture, conventional causticization has several major drawbacks including:

- a comparatively large demand for high-temperature heat,
- a causticization efficiency limited to 80-90%, and

- the alkalinity of the regenerated NaOH solution limited to about 1 mol/L.

[0014] Methods introducing alternative causticization processes have been widely investigated in the pulp and paper industry. Auto-causticization (using borate), direct causticization (using iron oxide or titanium dioxide) or partially auto- or direct-causticization has been addressed in a number of literature articles (Covey, 1982, Hoddenbagh et al., 2002, Kiiskilä, 1979a, 1979b, Nagano et al., 1974, Maddern, 1986, Palm and Theliander, 1997, Sinquefield et al., 2004, Yusuf and Cameron 2004 and Zou, 1991). The term “auto-causticization” may be used when the reaction product is water soluble and the decarbonizing agent is carried out through the entire pulping and recovery cycle as a caustic solution. In this process the caustic solution causticized itself during combustion or gasification. The term direct causticization may be used when the reaction product is insoluble in a caustic solution and the decarbonizing agent is separated from the caustic solution and is not carried through the liquor cycle. In this process the decarbonizing agent is added and subsequently removed.

[0015] The most commonly proposed method for air capture is a wet scrubbing technique which absorbs CO₂ in an alkaline absorbent, i.e. sodium hydroxide producing an aqueous solution of sodium hydroxide and sodium carbonate. Most previous work has assumed that the absorbent would be regenerated and CO₂ liberated from the alkaline carbonate solution using a lime (Ca(OH)₂) and calcium carbonate causticization cycle.

SUMMARY

[0016] The methods described herein are described in terms of various steps which, as a person of ordinary skill in the art would recognize from reading the specification, can be performed individually, simultaneously, for example, in one pot, or in any combination thereof.

[0017] A method of carbon dioxide capture is disclosed. In a step (a), gas containing carbon dioxide is scrubbed with an aqueous solution of sodium hydroxide to react the carbon dioxide to form a first aqueous solution containing

sodium carbonate. In step (b) anhydrous sodium carbonate is separated from the first aqueous solution. In step (c) the anhydrous sodium carbonate is treated by causticization to generate carbon dioxide and sodium hydroxide. In some embodiments, causticization comprises at least one of auto-causticization and direct causticization.

[0018] In some embodiments, step (c) further comprises step (c 1) and (c2). In step (c 1), the anhydrous sodium carbonate is reacted with sodium tri-titanate to produce carbon dioxide gas and sodium penta-titanate. In step (c2) sodium hydroxide and sodium tri-titanate are regenerated from the sodium penta-titanate.

[0019] A method of making anhydrous sodium carbonate from a first aqueous solution containing sodium carbonate is also disclosed. In some embodiments, step (b) can comprise step (x) and (y). In step (x), a hydrate of sodium carbonate is separated from the first aqueous solution. In step (y), the hydrate of sodium carbonate is dissolved in a second aqueous solution and the second aqueous solution is heated to at or above the transition temperature of monohydrate sodium carbonate and anhydrous sodium carbonate precipitation to produce the anhydrous sodium carbonate. In some embodiments, step (y) further comprises introducing at least one secondary solute to the second aqueous solution to lower the solubility of the anhydrous sodium carbonate. In some embodiments, the anhydrous sodium carbonate produced in step (y) is treated by causticization to generate carbon dioxide and sodium hydroxide.

[0020] A method of carbon dioxide capture is also disclosed. In a step (a), a gas containing carbon dioxide is scrubbed with an aqueous solution of an alkali metal hydroxide to react the carbon dioxide to form a first aqueous solution containing alkali metal carbonate. In a step (b), anhydrous alkali metal carbonate is separated from the first aqueous solution. In a step (c) the anhydrous alkali metal carbonate is treated by causticization to generate carbon dioxide and alkali metal hydroxide. In some embodiments, the alkali metal comprises at least one alkali metal. In some embodiments, the alkali metal hydroxide comprises potassium hydroxide.

[0021] Disclosed herein is a novel technique for recovering of sodium hydroxide

from an aqueous alkaline solution of sodium carbonate. In the first step anhydrous sodium carbonate is separated from the concentrated sodium hydroxide solution using a two step precipitation and crystallization process. The anhydrous sodium carbonate is then causticized using sodium tri-titanate. In the causticization process, sodium hydroxide is regenerated and carbon dioxide is liberated as a pure stream, which is compressed for use or disposal. The technique requires ~50% less high-grade heat than conventional causticization and the maximum temperature required is reduced by at least 50°C. This titanate process may allow a substantial reduction in the overall cost of direct air capture.

[0022] The details of one or more embodiments of the invention are set forth in the accompanying drawings and the description below. Other features, objects, and advantages of the invention will be apparent from the description and drawings, and from the claims.

BRIEF DESCRIPTION OF THE FIGURES

[0023] Embodiments will now be described with reference to the figures, in which like reference characters denote like elements, by way of example, and in which:

[0024] Figure 1: Block diagram of one embodiment for chemical recovery using titanates in air capture.

[0025] Figure 2: An embodiment of a process design for air capture using a titanate chemical recovery cycle.

[0026] Figure 3: An embodiment of a process design for air capture using a titanate chemical recovery cycle.

[0027] Figure 4: Solubility of sodium carbonate in water. The four labeled dots provide a schematic indication of the process for separating anhydrous Na_2CO_3 according to an embodiment of a method disclosed herein. A solution of Na_2CO_3 at point 'A', is cooled to point 'B' precipitating decahydrate ($\text{Na}_2\text{CO}_3 \cdot 10\text{H}_2\text{O}$). The decahydrate may be then be dissolved at C and heated to D to precipitate anhydrous

sodium carbonate.

[0028] Figure 5: Solubility of sodium carbonate in water and 1.5, 3 and 5M NaOH solution. The separated crystals of sodium carbonate decahydrate are dissolved in water at $\sim 30^{\circ}\text{C}$ to produce a saturated solution indicated by the point 'C'. The solution is heated to about 100°C (point 'D') at which due to hydrolysis of added sodium penta-titanate, NaOH is leached out; this would in turn cause the sodium carbonate to precipitate as anhydrous sodium carbonate. Depending on the concentration of leached NaOH, the solubility of sodium carbonate would drop to points E, F or G.

[0029] Figure 6: Dependency of transition T between monohydrate and anhydrous on NaOH concentration.

[0030] Figure 7: Enthalpy change for Titanate cycle and Lime ($\text{Ca}(\text{OH})_2$) cycle. The moisture content of 30%wt was assumed for CaCO_3 .

a-b Heating $\text{Na}_2\text{CO}_{3(\text{aq})}$	1-2 Heating moisture content of CaCO_3
b-c Heating $\text{Na}_2\text{CO}_{3(\text{s})}$ and $\text{Na}_2\text{O} \cdot 3\text{TiO}_2$	2-3 Vaporizing moisture
c-d Decarbonation reaction	3-4 Heating $\text{CaCO}_{3(\text{s})}$
d-e Cooling $\text{CO}_{2(\text{g})}$ and $4\text{Na}_2\text{O} \cdot 5\text{TiO}_2$	4-5 Calcination reaction
e-f Leaching reaction	5-6 Cooling $\text{CaO}_{(\text{s})}$ and $\text{CO}_{2(\text{g})}$
	6-7 Slaking reaction
	7-8 Cooling $\text{CO}_{2(\text{g})}$

[0031] Fig. 8 is a schematic of one embodiment of a process as illustrated in Fig. 3.

[0032] Fig. 9 is a schematic of one embodiment of a process as illustrated in Fig. 2.

[0033] Fig. 10 is an XRD (X-ray diffractometry) graph of sodium carbonate decahydrate.

[0034] Fig. 11 is a graph of the solubility of Na_2CO_3 in water, with calculations made for one example described in the detailed description.

[0035] Fig. 12 is a flow diagram of the simultaneous leaching and anhydrous Na_2CO_3 reaction.

[0036] Fig. 13 is an XRD graph of the filter cake from the leaching test where the final concentration of NaOH was 5M.

[0037] Fig. 14 is an XRD graph of the filter cake from the leaching test where the final concentration of NaOH was 3M.

[0038] Fig. 15 is an example of the titration data of the filtrate from a leaching test example.

[0039] Fig. 16 is an example of the effect of temperature on the decarbonization reaction [4].

[0040] Fig. 17 is an example of the effect of steam at 900°C (a) and 1000°C (b) on the decarbonization reaction [4].

[0041] Fig. 18 is an example of the effect of CO_2 on decarbonization reaction [4] at (a) 900°C and (b) 1000°C.

[0042] Fig. 19 is an example of the effect of temperature on decarbonization in 30% CO_2 -70% N_2 .

[0043] Fig. 20 is an example of the effect of steam and CO_2 at 900°C.

DETAILED DESCRIPTION

[0044] A number of embodiments are described. The embodiments are selected examples and are non-limiting. A person of skill in the art will understand from reading the present specification that various modifications may be made to the described embodiments and that other embodiments exist that are within the spirit and scope of the invention.

[0045] *Process description*

[0046] Figure 1 illustrates a simplified schematic sketch of a proposed process for the regeneration step in capturing CO₂ from air which is viewed as a two step process requiring a precipitation and a decarbonization step. In some embodiments, precipitation may broadly refer to, for example, separating and crystallizing. Non-limiting flow sheets detailing some embodiments of the process are illustrated in Figures 2 and 3. Referring to Fig. 1, an embodiment of a method of carbon dioxide capture is disclosed. In a step (a), carried out, for example, in a contactor, gas containing carbon dioxide is scrubbed with an aqueous solution of sodium hydroxide to react the carbon dioxide to form a first aqueous solution containing sodium carbonate. Scrubbing may refer to, for example, any method of removing CO₂ from gas. Referring to Fig. 1, in a step (b), anhydrous sodium carbonate can be separated from the first aqueous solution. As illustrated, separating anhydrous sodium carbonate from the first aqueous solution may involve more than one step, and may involve more than one solution. Referring to Fig. 2, one example of such separation is illustrated as being carried out in two crystallizers. Referring to Fig. 1, in a step (c), the anhydrous sodium carbonate is treated by causticization to generate carbon dioxide and sodium hydroxide. Referring to Fig. 2, one example of causticization is illustrated as being carried out in a fluidized bed reactor. Referring to Fig. 1, in some embodiments, causticization comprises at least one of auto-causticization and direct causticization. In some embodiments, step (c) may further comprise steps (c1) and (c2). Referring to Fig. 2, for example, in a step (c1) the anhydrous sodium carbonate can be reacted with sodium tri-titanate to produce carbon dioxide gas and sodium penta-titanate, in the fluidized bed reactor. In a step (c2), for example, sodium hydroxide and sodium tri-titanate can be regenerated from the sodium penta-titanate, in, for example, a leaching unit.

[0047] In some embodiments, referring to Fig. 3, methods of making anhydrous sodium carbonate from a first aqueous solution containing sodium carbonate can comprise the steps of (x) and (y). The first aqueous solution may be obtained from, for example, a carbon dioxide capture system as illustrated in Figs. 2 and 3. In some embodiments, step (b) may further comprise steps (x) and (y). In step (x), a hydrate of sodium carbonate can be separated from the first aqueous

solution. In some embodiments, the first aqueous solution contains sodium hydroxide. In step (y) the hydrate of sodium carbonate can be dissolved in a second aqueous solution and the second aqueous solution can be heated to a temperature at or above the transition temperature of monohydrate sodium carbonate and anhydrous sodium carbonate precipitation to produce the anhydrous sodium carbonate. The second aqueous solution may initially be, for example, pure or trace contaminated water, prior to any dissolution of sodium carbonate therein, or the second aqueous solution may have other species present therein. The dissolving and heating of step (y) may occur in any order, for example heating and then dissolving, or dissolving and then heating. Steps (x) and (y) can be carried out in the crystallizers, for example. The concentration of sodium carbonate in the first aqueous solution may be lower than the concentration of sodium carbonate in the second aqueous solution. An example of this is illustrated in the schematic in Fig. 2, as the first aqueous solution has a concentration of 0.37 M Na_2CO_3 , and the second aqueous solution has a concentration of 30%, or 2.8 M, sodium carbonate. In some embodiments, the anhydrous sodium carbonate produced in step (y) is treated by causticization to generate carbon dioxide and sodium hydroxide. Causticization may comprise at least one of auto-causticization and direct causticization.

[0048] Referring to Fig. 3, in some embodiments, the precipitation unit may be a two-stage crystallization/precipitation unit for precipitating anhydrous sodium carbonate from a concentrated alkaline aqueous solution (e.g., the solution of steps (x) and (y)). In the first crystallization stage, sodium carbonate decahydrate, for example, may be crystallized from a concentrated alkaline aqueous solution, and in the second stage, anhydrous sodium carbonate can be precipitated from a saturated sodium carbonate aqueous solution simultaneously as the sodium penta-titanate is hydrolyzed at elevated temperature. In other embodiments, the hydrate may be a monohydrate, heptahydrate, or decahydrate, or any mixtures thereof, for example. In some embodiments, the hydrolysis of sodium penta-titanate can include the addition of aqueous sodium hydroxide to the solution which lowers the solubility of sodium carbonate forcing the precipitation of sodium carbonate, and will be explained in greater detail below. The solid anhydrous sodium carbonate may then be, for example, causticized using direct causticization with titanate in the causticization unit where CO_2 is liberated from sodium carbonate and sodium hydroxide is

regenerated and recycled to the contactor.

[0049] In some embodiments, at temperatures above about 100°C, the precipitated sodium carbonate will be in the anhydrous form needed for the reaction with tri-titanate, thus reducing the process energy requirements. The sodium hydroxide can be regenerated by the hydrolysis of sodium penta-titanate and recycled to the contactor as a subsequent first aqueous solution, and the solid anhydrous sodium carbonate may then be causticized using direct causticization with titanate, in the causticization unit where CO₂ is liberated from sodium carbonate.

[0050] *Separation of sodium carbonate from concentrated alkaline reservoir solution*

[0051] If sodium carbonate is going to be converted to sodium hydroxide via a direct causticization process, it may first be separated from concentrated alkaline solution in a relatively pure solid stream. This is important because (1) the causticization reaction with titanium dioxide or recycled sodium tri-titanate is a solid state or solid-smelt state reaction and the presence of aqueous phase along with sodium carbonate can dramatically increase the energy demand due to evaporation, (2) the presence of sodium hydroxide along with sodium carbonate in the causticization reactor can cause the formation of sticky particles and the vaporization of sodium metal which can lead to corrosion, (3) the presence of sodium hydroxide can decrease the melting point of sodium carbonate.

[0052] Before describing the process design, a review of the solubility of sodium carbonate in water and in hydroxide is provided and an examination of the influence of temperature and hydroxide ion concentration on solubility is provided.

[0053] *Solubility data for sodium carbonate – water system*

[0054] The solubility data, solid phases and transition temperatures for sodium carbonate-water systems have been reviewed and collated. Sodium carbonate, whose anhydrous and monohydrated forms dissolve exothermally, shows a complex pattern of solubility. In the region in which the equilibrium salt phase is anhydrous,

indicated by region 10, its solubility decreases with increasing temperature, see Figure 4. Referring to Fig. 4, regions 12, 14, and 16 refer to regions of monohydrate, decahydrate, and heptahydrate equilibrium salt phase, respectively. Transition points in the sodium carbonate-water system are shown below in Table 1, in which the temperature at the transition point between sodium carbonate mono-hydrate and sodium anhydrous carbonate is 109°C with no secondary solute present. The sodium carbonate in the second aqueous solution may have a concentration that is at or above the saturation concentration of sodium carbonate at the temperature the second aqueous solution is heated to. The saturation concentration is understood to be a function of, for example, temperature, pressure, and secondary solute concentration (see Fig. 5). As illustrated in Fig. 4, the concentration of sodium carbonate in the second aqueous solution may be equal to or less than 31%wt.

[0055] Table 1: Temperature at transition points in Na₂CO₃-H₂O system

Phases	Temp, °C
Na ₂ CO ₃ .10H ₂ O – ice	-2.1
Na ₂ CO ₃ .10H ₂ O - Na ₂ CO ₃ .7H ₂ O	32.00
Na ₂ CO ₃ .10H ₂ O - Na ₂ CO ₃ .H ₂ O	32.96
Na ₂ CO ₃ .7H ₂ O - Na ₂ CO ₃ .H ₂ O	35.37
Boiling point	104.8
Na ₂ CO ₃ .H ₂ O - Na ₂ CO ₃	109

[0056] Sodium carbonate can be crystallized as various hydrates. Based on solubility data for sodium carbonate-water system, at 30%wt sodium carbonate concentration, the solution becomes super-saturated at $T \geq 118^\circ\text{C}$ and the formation of sodium anhydrous carbonate crystals, known as primary nucleation, can start at this point. The transition temperature between sodium carbonate monohydrate and anhydrous sodium carbonate is higher than the boiling point of a saturated sodium carbonate solution (about 30%wt, or 2.8 M for example) (see Figure 4 and Table 1).

[0057] Different methods may be applied to produce anhydrous sodium carbonate from a pure aqueous solution. Operating under pressurized condition is one way to raise the boiling temperature (which may be 105.7°C) above the transition temperature (which may be 109°C when no secondary solute is present). The other way, mostly presented in the literature, is to crystallize sodium carbonate at lower

temperatures either as sodium carbonate decahydrate ($\text{Na}_2\text{CO}_3 \cdot 10\text{H}_2\text{O}$) or monohydrate ($\text{Na}_2\text{CO}_3 \cdot \text{H}_2\text{O}$), and then calcine the hydrates. The hydrates are calcined at 150° to 200°C to obtain the anhydrous form. The thermal dehydration of sodium carbonate hydrates is, however, considerably endothermic, and the values of 52.67 and 58.77 kJ/mol H_2O have been cited for decahydrate and monohydrate, respectively. These values are appreciably greater than the heat of vaporization of liquid water at 298 K, which amounts for 44 kJ/mol H_2O . An alternative crystallization method may be used, in which a suitable anti-solvent is used to decrease the solubility of the salt and also to lower the water activity. This means that the transition temperature is lowered and an anhydrate can be produced directly at lower temperatures, even below the boiling point of the solution. Addition of ethylene glycol by 25%wt, for example, can increase the boiling point of the solution from 105.7°C to 106.8°C and lower the transition point from 109°C to 105.7°C.

[0058] *Solubility data for sodium carbonate – sodium hydroxide system*

[0059] The ternary system of Na_2CO_3 - NaOH - H_2O has been studied, and the solubility of carbonate salts, in general, was found to drop in the presence of secondary solutes, such as hydroxide ions. Figure 5 illustrates a summary of the data on solubility of sodium carbonate at different temperatures and concentrations of an NaOH solution, 5, 10 and 17% corresponding to 1.5, 3 and 5 M NaOH .

[0060] In some embodiments, step (y) further comprises introducing at least one secondary solute to the second aqueous solution to lower the solubility of the anhydrous sodium carbonate. In further embodiments, the at least one secondary solute comprises sodium hydroxide. As it is shown in Figure 5, in general, the solubility curve for sodium carbonate in the presence of sodium hydroxide in the solution follows the same pattern as the solubility curve for Na_2CO_3 -water system and that at the higher concentration of NaOH , based on the solubility product rule, the solubility of sodium carbonate can drop significantly. Referring to Fig. 3, the sodium hydroxide may be introduced to the second aqueous solution with the addition of sodium penta-titanate into the second aqueous solution. Sodium penta-titanate added into the second crystallizer, as shown in Fig. 3, can hydrolyze into

sodium hydroxide and sodium tri-titanate. The increase in concentration of sodium hydroxide thus introduced can then lower the solubility of sodium carbonate according to the graph of Fig. 5, aiding in the separation of anhydrous sodium carbonate. In the embodiment illustrated, step (y) may further comprise producing the anhydrous sodium carbonate and sodium tri-titanate together. This may be accomplished by removing a solid mass of sodium tri-titanate and anhydrous sodium carbonate together, for example. In further embodiments, the produced sodium tri-titanate and anhydrous sodium carbonate may be produced in stoichiometric ratios for efficient completion of the causticization reaction.

[0061] Referring to Fig. 6, the transition temperature of sodium carbonate monohydrate and anhydrous sodium carbonate can be influenced by the concentration of a secondary solute, such as sodium hydroxide. Addition of other soluble substances, e.g. sodium hydroxide, to a saturated aqueous solution of sodium carbonate can cause a reduction in its vapor pressure which results in an elevation of its normal boiling point and a reduction of the transition temperature from sodium carbonate monohydrate to anhydrous sodium carbonate.

[0062] *Process design for the separation of anhydrous sodium carbonate from alkaline solution*

[0063] Earlier studies on obtaining anhydrous sodium carbonate deal mostly with the separation of anhydrous sodium carbonate from crude sodium sesquicarbonate or brine solution. The precipitation of anhydrous sodium carbonate from an aqueous solution of sodium carbonate and sodium hydroxide has not been addressed in the literature. In this document, therefore, disclosed is a method to precipitate 95% pure anhydrous sodium carbonate from a concentrated alkaline solution which may be used as the absorbent to capture CO₂ from ambient air.

[0064] In the disclosed process, sodium carbonate may be precipitated as sodium carbonate decahydrate, Na₂CO₃·10H₂O, from a, for example, saturated solution of Na₂CO₃-NaOH (in the reservoir), e.g. 0.7M Na₂CO₃ in 5M NaOH at 20 °C, by means of a temperature swing, e.g. from 25°C to 10°C. The concentration of dissolved Na₂CO₃ in

the reservoir is a critical operational parameter; Table 2 illustrates a range of carbonate concentrations in the solution as a function of temperature. In some embodiments, step (x) further comprises adding at least one secondary solute, for example sodium hydroxide, to the first aqueous solution containing sodium carbonate in order to lower the solubility of the hydrate of sodium carbonate. In this document, secondary solute may be any solvent or solid, for example sodium hydroxide, that lowers the solubility of sodium carbonate in water. As illustrated, in some embodiments, step (x) further comprises cooling the first aqueous solution to separate the hydrate of sodium carbonate from the first aqueous solution, illustrated by, for example, dots A to B in Fig. 4. Referring to Fig. 4, running the reservoir with carbonate close to saturation minimizes the energy required for the temperature swing, but if the concentration is too close to saturation there may be carbonate precipitation in the monohydrate or heptahydrate regions, for example. In further embodiments, step (x) further comprises cooling the first aqueous solution containing sodium carbonate to a temperature above 0° C. In some embodiments, the hydrate of sodium carbonate is dissolved in the second aqueous solution in step (y) at elevated temperature. The elevated temperature may be, for example, between 20 and 31°C as illustrated in Fig. 4. The four labeled dots in Figure 4 illustrate a schematic indication of sodium carbonate decahydrate precipitation. Although the separation process is illustrated only for the Na₂CO₃-water system, the separation process for Na₂CO₃ from Na₂CO₃-NaOH-H₂O would follow the same concept.

[0065] Table 2 : The changes in concentrations of carbonate when NaOH is present at different

Ambient T (°C)	NaOH concentration in reservoir (mol/L)	Maximum Carbonate Concentration (mol/L)	T swing (ΔT, °C)	Carbonate concentration out (mol/L)	Precipitated carbonate (ΔC)
30	5	0.9	20	0.42	0.48
25	5	0.85	15	0.42	0.43
20	3	1		0.55	0.45
	5	0.75	10	0.42	0.33
	3	0.75		0.55	0.2
15	5	0.55	5	0.42	0.13

[0066] While crystallization of sodium carbonate decahydrate can be initiated by imposing a sufficiently large temperature swing, a practical large-scale process can require that crystals be grown to a large enough size that they can be cost effectively

removed from solution with a minimum of solution carry-over. Different crystallizer designs which use a cooling process are available. For example, a draft tube baffle (DTB) crystallizer from Swenson Crystallization Equipment can be useful for crystallizing sodium carbonate decahydrate. This crystallizer includes a baffle section surrounding a suspended magma of growing crystals from which a stream of mother liquor is removed containing excess fine crystals. These fines can be destroyed by adding heat (as in an evaporative crystallizer) or by adding water or unsaturated feed solution. The magma is suspended by means of a large, slow-moving propeller circulator which fluidizes the suspension and maintains relatively uniform crystal growth zone conditions. Another design may be a pellet reactor type crystallizer which is called a "Crystalactor", and may be made by DHV Water AB, for example. A pellet reactor type crystallizer may also be a fluidized pellet reactor. The crystalactor is filled with suitable seeding material and can be used to speed up the crystallization of sodium carbonate decahydrate. The crystalactor has been used for metal and anion recovery from waste water. This type of crystallizer has also been studied for precipitation of other metal-carbonates. The fluidized bed provides a very large crystallization surface and in a fast controlled reaction almost all the anion crystallizes directly from the solution into the crystal lattice. Therefore, pure, almost alkaline-free salt with a moisture content of only 5-10% may be produced after atmospheric drying.

[0067] After separation of pure $\text{Na}_2\text{CO}_3 \cdot 10\text{H}_2\text{O}$, the crystals may be dissolved in warm water (at temperatures above 30°C , for example) to a total concentration of, for example, 2.8M (30%wt) at a pH level of about 12. It should be mentioned that, in some embodiments, the pH level in the process units is high enough to reduce co-crystallization of any sodium bicarbonate crystals during the process (i.e. sodium bicarbonate precipitates at pH between 6 and 9, while the pH level for the process is always kept above 12). Therefore, in some embodiments, the pH of the first aqueous solution is high enough in step (y) to reduce co-crystallization of sodium bicarbonate. In some embodiments, the pH of the first aqueous solution is high enough in step (b) to reduce co-crystallization of sodium bicarbonate. In order to precipitate anhydrous sodium carbonate from this aqueous solution, the solution may be heated to temperatures above 118°C . However, as stated earlier, the boiling point of a 30%wt sodium carbonate solution is 105.7°C . To avoid boiling, the system, for example the

container containing the solution, might be pressurized. In some embodiments, the anhydrous sodium carbonate is produced in step (y) at elevated pressure. Pressurized operation can be economically feasible because pressures as low as 1.6 bar may suffice to prevent or reduce evaporation. For example, at 118°C, the minimum pressure to prevent evaporation of water may be 1.8 bar. The 1.8 bar pressure may be the upper limit for Na₂CO₃-H₂O system, because the boiling point of water in general increases by adding a salt to the system. The boiling point of Na₂CO₃-H₂O solution would, therefore, be higher than the boiling point of water. Crystallization of anhydrous sodium carbonate can also be accomplished by removing water using an evaporative process or reverse osmosis. Alternatively, it might be achieved by use of anti-solvents, however, the addition of anti-solvents is probably not applicable to an air capture process because of hazardous organic vapor emissions into air through the introduction of a few percent of organic anti-solvents into the alkaline solution which is sprayed in the contactor.

[0068] In some embodiments, an alternative process can include introduction of a secondary solute, such as sodium hydroxide, into the solution when the solution is heated to a temperature close to but below the boiling point. Referring to Fig. 5, this could drop the solubility and anhydrous Na₂CO₃ could precipitate, e.g. dropping the solubility from point D to E in Figure 5. In one embodiment, 610%wt NaOH is added. Fig. 5 illustrates the solubility of sodium carbonate at concentrations of 0, 1.5, 3, and 5 M NaOH. Points D-G illustrate the difference in solubility as the solution increases from 0 to 5M NaOH at temperatures of about 100°C. In some embodiments, the secondary solute addition may increase the boiling point of water, in addition to, or instead of, reducing the saturation concentration of sodium carbonate. Referring to Fig. 6, the transition temperature between sodium carbonate monohydrate and anhydrous sodium carbonate can shift from 109°C in Na₂CO₃-water solution to about 97 °C in a Na₂CO₃-NaOH-water system with a final concentration of about 5M of NaOH. The phase boundary of sodium carbonate can, therefore, shift to permit the crystallization to be carried out at atmospheric pressure while still growing crystals of anhydrous sodium carbonate.

[0069] In some embodiments, a high concentration of NaOH in a saturated solution of sodium carbonate at elevated temperature is provided and disclosed is a

process in which anhydrous sodium carbonate can be precipitated simultaneously as the sodium penta-titanate from the decarbonization unit is hydrolyzed to leach sodium hydroxide, see reaction[5]. The leaching of sodium hydroxide from sodium penta-titanate is an endothermic reaction, $\Delta H = 15.2 \text{ kJ/mol CO}_2$, and experimental data at temperatures of 70 and 100°C has shown that the leaching rate at about 100°C can be high enough to produce a maximum 5M aqueous solution of sodium hydroxide.

[0070] In some embodiments, the proposed process can work as follows: penta-titanate can be added to the ~2.8M saturated sodium carbonate solution at temperatures of ~ 100°C. The sodium penta-titanate can hydrolyze releasing NaOH which drives the sodium carbonate out of solution. The leaching of sodium hydroxide can shift the solubility curve of sodium carbonate as well as the transition temperature of sodium carbonate monohydrate and anhydrous sodium carbonate precipitation. A preliminary laboratory study for the simultaneous reactions was done successfully and is disclosed below. More specifically, sodium hydroxide was successfully leached out from sodium penta-titanate, and the concentration controlled so that a 3 and 5M sodium hydroxide solution was produced and the anhydrous sodium carbonate was precipitated at a temperature of ~100°C. The more detailed leaching kinetics study and the influence of dissolved sodium carbonate are being investigated.

[0071] *Decarbonation of sodium carbonate via direct causticization*

[0072] Thermodynamics of the titanate reaction has been widely studied, beginning as early as 1979 by Kiiskila. The lower limit for reaction temperature is 840°C in order to achieve sufficiently high reaction rates due to reaction [5]. This reaction is endothermic, meaning that the reaction rate is higher at higher temperature. At temperatures above the melting point of sodium carbonate, for example, the enthalpy of reaction [5] was reported to be 62 kJ/mol CO₂, whereas at temperatures below the melting point and above 840°C, the enthalpy of reaction [5] is 90 kJ/mol CO₂. The enthalpy of fusion for Na₂CO₃ is 25.7 kJ/mol, which is approximately equal to the difference between the enthalpy of reaction [5] above and below the melting point. So the net enthalpy of reaction is about the same in either case. In

some embodiments, step (c1) is carried out at temperatures at or above the melting point of anhydrous sodium carbonate.

[0073] After a thorough thermodynamical analysis, it may be found that although the reaction can be carried out in solid state, at temperatures slightly above the melting point ($\sim 860^{\circ}\text{C}$), the total energy requirement for heating the reactant and the reaction is 3% less than for temperatures below the melting point. Moreover, at temperatures slightly above the melting point, the total energy that can be recovered from cooling of the products is $\sim 3\%$ more than for the temperatures below melting point. This would, in turn, lead to 6% more energy efficiency when causticization is carried out at temperatures slightly above the melting point. The reaction rate is also higher at temperatures slightly above the melting point, which is of great importance for the residence time in the fluidized-bed reactor.

[0074] The parameters influencing the kinetics of reaction [5] are thought to be the particle size of both sodium carbonate and titanium dioxide and the molar ratio of titanium dioxide and sodium carbonate ($\text{TiO}_2/\text{Na}_2\text{CO}_3$). It has been found that all of the sodium carbonate is converted below its melting point (858°C) for particle sizes $< 25\ \mu\text{m}$ and $\text{TiO}_2/\text{Na}_2\text{CO}_3=1.25$, indicating that the reaction can be carried out successfully in the solid state. However, when larger particle sizes, e.g. $63\ \mu\text{m}$, or smaller molar ratios, e.g. $\text{TiO}_2/\text{Na}_2\text{CO}_3=1$, were used, the causticization reaction was slower than the previous cases at temperatures below the sodium carbonate melting point.

[0075] Besides the parameters discussed above, the partial pressure of CO_2 in the reaction atmosphere seems to influence the reaction kinetics as well. The mechanism is not yet clearly understood. There may be a retarding effect of CO_2 partial pressure on reaction rate. A thorough investigation of the mechanism for the influence of CO_2 partial pressure on titanate reaction may be required, in order to separate a CO_2 stream at partial pressures of about 1 bar from the fluidized bed reactor. This would simplify the compression of separated CO_2 to higher pressures of about 100 bar.

[0076] In some embodiments, the method may further comprise steps (e) and (f).

In step (e), anhydrous sodium carbonate is separated from a subsequent first aqueous solution containing sodium carbonate. The subsequent aqueous solution may be derived from the initial aqueous solution. Referring to Figs. 2 and 3, this is illustrated in the cycle of the process. In step (f), the anhydrous sodium carbonate separated in step (e) is treated by causticization to generate carbon dioxide and sodium hydroxide. The method may also further comprise a step (d) in which a subsequent gas containing carbon dioxide is scrubbed with the subsequent aqueous solution of sodium hydroxide to react the carbon dioxide to form the subsequent first aqueous solution containing sodium carbonate. In other embodiments, at least one of the first aqueous solution containing sodium carbonate and the subsequent first aqueous solution containing sodium carbonate may be derived from processes other than gas scrubbing. Referring to Fig. 3, in some embodiments, step (c2) further comprises hydrolyzing the sodium penta-titanate in the separation of anhydrous sodium carbonate in step (e) to regenerate sodium hydroxide and sodium tri-titanate. In further embodiments, such as the one illustrated in Fig. 3, step (e) further comprises producing the anhydrous sodium carbonate and sodium tri-titanate together. In some embodiments, the subsequent aqueous solution of sodium hydroxide can be formed with the sodium hydroxide generated in step (c).

[0077] It should be understood that various modifications and variations may be made to the design and process engineering of the system for heating the mixed carbonate/titanate particles disclosed herein. Design alternatives that provide for heat and CO₂ recovery are provided.

[0078] For example, highly efficient kilns for heating fine particles to temperatures above that required here have been developed for lime (Ca(OH)₂) production. The so-called 'D' kilns developed by the Italian lime kiln manufacturer, Cimprogetti, have demonstrated thermal efficiencies above 90% in large-scale applications. The efficiency comes from a counter flow design in which the particles drop through upward flowing gas. In the upper section of the kiln the cool particles are heated by the hot exhaust gases creating a counter current heat exchanger. The calcination reaction proceeds in the middle of the kiln. In the lower section of the kiln the hot particles fall through the incoming air preheating it. Similar kiln designs may be readily adapted to drive the tri-titanate to penta-titanate reaction.

[0079] The most conservative and lowest capital cost approach may be to use natural gas fired in air as an indirect heat source. This approach would require minimal adaptation of existing kiln designs, and would presumably carry a small technical risk. The CO₂ released from natural gas combustion is only ~1/6 of the CO₂ captured from air so one might simply ignore the CO₂ produced by combustion. Alternatively, one could use a post combustion process such as amines or chilled ammonia from the exhaust gases.

[0080] In some embodiments, a more advanced and perhaps more cost-effective design could use recirculating CO₂ into which heat introduced by an "oxyfuel" mixture of oxygen and natural gas or syngas. The design of such systems could be adapted from the many design studies for oxyfuel coal fired power plants which are now being applied at scales of greater than 30 MW. In this case, the primary operating gas would be CO₂ at atmospheric pressure or above. The presence of CO₂ at atmospheric pressure may, however, cause problems in the titanate kinetics.

[0081] In another embodiment, the design could use indirect heat provided by a high temperature gas cooled reactor (HTGR). The second generation of HTGR reactors is currently being developed by several companies including PBMR, ARIVA, and General Atomics. The first commercial scale passively-safe PBRM reactor is expected to start construction in 2009. In these reactors the primary loop helium temperature is ~900°C, and the secondary loop temperature can be above 850°C. It might therefore be practical to drive the titanate reactions using indirect heat provided by the secondary helium loop from an HTGR. In this design essentially the only gas inside the kiln would be CO₂ since no water would be introduced by combustion as is the case for oxyfuel.

[0082] HTGR's arguably could provide the lowest cost source of carbon neutral high grade heat. If HTGR's are the power source, then the titanate process described here has another advantage, other than energy efficiency, over the calcination process because that titanate process can be operated at temperatures as low as 800°C, whereas the calcination process requires temperatures of ~950°C (assuming atmospheric pressure CO₂). Current HTGR designs cannot practically supply heat at

950°C.

[0083] *Energy and exergy analysis*

[0084] A thermodynamical evaluation for the conventional causticization and the direct causticization using titanates has been carried out and it was determined that the process with highest potential from both energy and energy equality perspective is the titanate process. It should be mentioned that in these studies solid sodium carbonate was used to perform a fair comparison between the two processes.

[0085] In this section, the results of the energy and exergy analysis are shown for the recovery cycle using titanate in which sodium carbonate and lean sodium hydroxide enters the cycle and carbon dioxide and rich sodium hydroxide leaves the cycle as the products. The other substances are recycled between the different units. Note that the starting point for sodium carbonate is the aqueous alkaline solution of $\text{Na}_2\text{CO}_3\text{-NaOH}$ from the reservoir solution. The energy analysis for the CO_2 absorption section, "contactor", can be found elsewhere. In this document, a total energy requirement of ~ 130 kJ/mol CO_2 is estimated for the recovery cycle using titanate. As shown in Table 3, the highest exergy levels correspond to the decarbonation reaction, heating of reactants and cooling of products.

[0086] Table 3. Energy and exergy analysis*

	Enthalpy change	Temperature range	Exergy change
	ΔH (kJ/mol CO_2)	T °C	ΔE (kJ/mol CO_2)
Crystallizer 3 Enthalpy of crystallization for $\text{Na}_2\text{CO}_3 \cdot 10\text{H}_2\text{O}$	-68.86	10	-0.3
Combined Crystallizer/Leaching unit			
Heating $\text{Na}_2\text{CO}_3 \cdot 10\text{H}_2\text{O}$	8.86	10 → 31	2
Enthalpy of dissolution for $\text{Na}_2\text{CO}_3 \cdot 10\text{H}_2\text{O}$ to 30%wt	67.9	31	0.02
Enthalpy of crystallization for Na_2CO_3	25.1	103	1
Enthalpy of leaching reaction	15.2	100	-0.8
Heater 8			
Heating Na_2CO_3	123.4	100 → 860	93.6
Heating sodium tri-titanate	146.9	100 → 860	100.5
Fluidized bed reactor			

Enthalpy of reaction	65	860	-33.8
Cooler 11 Cooling CO ₂	-40.7	860 → 25	-22.1
Cooler 13 Cooling sodium tri-titanate	-213	860 → 100	-127.7
Total	130	-----	11.4
* Data for enthalpy and exergy calculation is taken from thermochemical database software HSC Chemistry v.6.12 Outotec Research, www.outotec.com.			

[0087] The amount of energy required by the titanate process is compared with the energy requirement in the lime (Ca(OH)₂) cycle in Figure 7 where enthalpy of change, ΔH, for titanate and lime processes at corresponding temperatures is illustrated. In Figure 7, the lime cycle is presented as a dashed line, labeled by numbers, whereas the titanate cycle is shown in solid lines labeled by letters. As illustrated, the required energy for the titanate process is about half of the required energy for the lime process (~ 135 as oppose to ~250 kJ/mol CO₂). In the lime cycle, the calcinations reaction consumes the most energy, and heat recovery from the calcination reaction products is poor. In the titanate cycle, however, most of the energy consumed for heating the reactants can theoretically be recovered by cooling of the reaction products. It should however be mentioned that because the energy requirement for heating and cooling of reactants and products are larger in the titanate process, the requirement on the heat transfer is more stringent.

[0088] Titanate processes may supply rather high concentrations of regenerated sodium hydroxide solution (~5M, for example) compared to conventional causticization (maximum 3.5M for example). This is because in conventional causticization using lime (Ca(OH)₂), the alkalinity of the NaOH solution produced due to reaction [1] is limited by the causticization reaction to 1M. For an air capture system, however, a more concentrated hydroxide solution, e.g. 3 or 5M, might be required depending on relative humidity (RH) and ambient temperature. Another issue with causticizing a concentrated alkaline reservoir solution with lime is the co-precipitation of calcium hydroxide with calcium carbonate. For these reasons, the conventional causticization using lime might not be as efficient for the concentrated reservoir solution as it is for causticizing sodium carbonate from a more dilute solution.

[0089] An energy efficient process for recovering sodium hydroxide for capturing CO₂ from ambient air is disclosed in this document. In some embodiments, the proposed process requires about half of the energy for the conventional causticization process using lime (Ca(OH)₂). The heat requirement of the proposed process is similar to the heat requirement for the sorbent regeneration for an amine-based CO₂ (MEA) capture system (for which an average of ~132 kJ/mol CO₂ has been reported) for power plants. The heat required for the use described herein may be high grade heat. Another potential advantage of this process over the conventional causticization process may be the lower temperature level, ~50 to 100°C, which may allow the heat integration between a high temperature gas cooled reactor from nuclear plants and the decarbonation reactor. Moreover, regeneration of concentrated sodium hydroxide may allow the contactor to significantly minimize the water loss.

[0090] Referring to Fig. 2, an embodiment of the method is illustrated. Figure 1 illustrates a schematic sketch of an embodiment of the proposed process for the regeneration step in capturing CO₂ from air. A more detailed flow sheet is illustrated in Figure 2. In the contactor, CO₂ is absorbed into a concentrated NaOH solution and converted to aqueous sodium carbonate. The reservoir solution is sent to the regeneration step which is composed of precipitation and causticization steps.

[0091] As it is shown in Figure 5, in general, the solubility curve for sodium carbonate in presence of sodium hydroxide in the solution follows the same pattern as the solubility curve for Na₂CO₃-water system. The higher concentration of NaOH, as expected, significantly lowers the solubility. This allows for precipitation of anhydrous sodium carbonate below the boiling point of the solution.

[0092] Studies of the direct causticization of sodium carbonate with titanium dioxide have been carried out. Depending on the feed molar ratio and temperature, the reaction between Na₂CO₃ and TiO₂ can lead to various sodium titanates as products. It has been found that the main decarbonization reaction in the direct causticization based on TiO₂ is the reaction between Na₂CO₃ and Na₂O.3TiO₂, i.e. reaction [4].

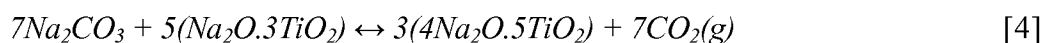

$$\Delta H_{850^{\circ}\text{C},s} = 90 \text{ kJ/mol CO}_2$$

$$\Delta H_{850^{\circ}\text{C},1} = 65 \text{ kJ/mol CO}_2$$

[0093] The formed sodium penta-titanate, $4\text{Na}_2\text{O}\cdot 5\text{TiO}_2$, can then be hydrolyzed, see equation [5], in a leaching unit at temperatures of about 100°C , to sodium hydroxide and sodium tri-titanate, the latter of which is recycled to the causticization unit.

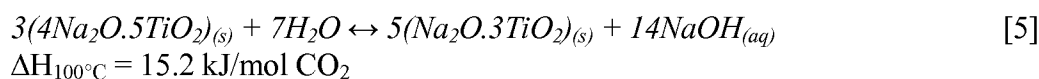

[0094] The kinetics of titanate reaction on a potassium-based process has been investigated, motivated by the possibility that that potassium carbonate might offer benefits over sodium carbonate in the pulping process such as the elimination of potassium build-up in sodium-based pulping. The kinetics of the reaction for absorbing CO_2 from air using potassium hydroxide is similar to a sodium-based process, and that the rate constant for capturing CO_2 from air using potassium hydroxide may, in some conditions, be approximately twice as large as that for sodium hydroxide. Thus, in some embodiments the air capture process may be based on potassium hydroxide.

[0095] The conventional titanate process cannot be directly applied to traditional air capture, however, because it requires pure and dry anhydrous sodium carbonate, and it is not obvious how to extract solid sodium carbonate from the rich solution of sodium hydroxide and sodium carbonate coming from the air capture contactor. This solution would typically have 1-4 M NaOH and less than 1 M of dissolved Na_2CO_3 . A major focus of this document, therefore, is on separation of anhydrous sodium carbonate from a concentrated alkaline reservoir solution, and preparation of a well-mixed stream of solid sodium carbonate and sodium tri-titanate, the latter is the reagent for decarbonizing of sodium carbonate via reaction [4]. This is a necessary step for applying the titanate process to air capture. After describing the process for recovering solid Na_2CO_3 , disclosed is an end-to-end energy and exergy analysis for the regeneration of NaOH via direct causticization using titanate as an alternative to conventional causticization.

[0096] *Crystallization of $\text{Na}_2\text{CO}_3\cdot 10\text{H}_2\text{O}$*

[0097] A 28%wt of sodium carbonate solution was prepared by dissolving 7.85 g

anhydrous sodium carbonate into 20.24 g deionized water (while stirring with a magnetic stirrer) and was heated to about 40°C to assure the complete dissolution of sodium carbonate. The solution of sodium carbonate was left at room temperature, - 22°C, for a day. The big chunk of crystal produced was weighed and analyzed by XRD (shown in Fig. 10). The weight of the crystal was 5.7 g. Assuming this was deca-crystal, the weight would correspond to 2.1 g Na₂CO₃, which means that ~26% of initial sodium carbonate is precipitated. Referring to Fig. 11, the 26% is almost equal to expected changes in wt% from the solubility curve if the solution is cooled from ~40 to ~22°C. 1.48 g of the crystal was then heated in an oven at 100°C, after which the weight change was 0.88. The weight change was identical to the amount of water which would be vaporized if all the 1.48g was sodium carbonate decahydrate, Na₂CO₃·10H₂O. This is a fair, simple analysis to illustrate that the crystal is Na₂CO₃·10H₂O.

[0098] Referring to Fig. 10, the crystal was also analyzed by XRD (X-ray diffractometry). The red bars represent the deca-carbonate peaks. The XRD also detected mono-hydrate structure. It should be mentioned that the Deca crystallizes at temperatures of ~20 to 5°C, and it has been reported that at temperature of about 10°C, the yield is more than 90%.

[0099] *Leaching/crystallization*

[0100] Two trials were performed, with NaOH_{final} = 3M, Na₂CO_{3, initial} = 3M in the first trial, and NaOH_{final} = 5M, Na₂CO_{3, initial} = 3M in the second trial. Referring to Fig. 5, the solubility of Na₂CO₃ in water and in NaOH solution at different concentrations is illustrated. Note: as the concentration of NaOH increases, the solubility curve shifts, and so the solubility of Na₂CO₃ decreases with increasing NaOH.

[0101] *Precipitation/leaching*

[0102] Referring to Fig. 12, the goal here was to precipitate Na₂CO₃(s) from Na₂CO₃(aq) solution with the simultaneous leaching of NaOH from sodium pentatitanate. The leaching reaction can be illustrated as equation [5] above. Sodium

penta-titanate was prepared by mixing a stoichiometric ratio of Na_2CO_3 and TiO_2 and heating up to $\sim 920^\circ\text{C}$ to achieve a complete conversion according to equation [4]. Several leaching tests were then carried out. Anhydrous Na_2CO_3 was precipitated when a total of 3M NaOH was leached at $T = \sim 100^\circ\text{C}$, and anhydrous Na_2CO_3 was precipitated when a total of 5M NaOH was leached at $T = \sim 100^\circ\text{C}$.

[0103] In the making of the penta-titanate, the reaction temperature was 920°C , and the time was 2 hours. The expected penta-titanate was 80 g, and the amount produced was 78.73 g.

[0104] In the leaching experiment, a reaction flask fitted with a condenser was filled with water and sodium carbonate (which is dissolved in water at elevated temperature). The reaction flask was heated in a hot oil bath to the desired temperature. Sodium penta-titanate was added at a temperature of 103°C , and the mixture was heated and stirred for 2 hours. The condenser prevented water vapor from being removed from the system.

[0105] *Filtering: Filter cake*

[0106] The suspension with white precipitate produced was then filtered and dried at 100°C where the final concentration of NaOH is 5M is illustrated. The light blue peak represents sodium tri-titanate (the highest intensity is at 2-theta of 10). It also shows that some sodium penta-titanate might be present. The XRD certainly shows the presence of anhydrous Na_2CO_3 . Referring to Fig. 14, the XRD for the filter cake from the leaching test where the final cons of NaOH was 3M is illustrated. The light blue peak represents sodium tri-titanate (the highest intensity is at 2-theta of 10). It also shows that some sodium penta-titanate might be present. The XRD certainly shows the presence of anhydrous Na_2CO_3 .

[0107] *Filtrates from filtering the suspension*

[0108] After centrifuging the filtrate, a titration was performed to analyze the concentration of dissolved carbonate anions as well as hydroxides. Referring to Fig. 15, an example of the titration data is illustrated. As illustrated, the measured values

of hydroxide and carbonate (2.60 and 1.8 M, respectively) are very close to the expected values (3.0 and 1.6 M, respectively). The expected values may be derived from the solubility graph illustrated in Fig. 5. This demonstrates that the experiment has worked properly. Furthermore, leaching of NaOH can simultaneously proceed with the precipitation of Na_2CO_3 .

[0109] *Process design – description*

[0110] *Method: simultaneous leaching and crystallization, as shown in Fig. 8.*

[0111] 1. Air contactor: The component of the system that provides the contacts between CO_2 and sodium hydroxide. In some embodiments, it can absorb CO_2 with a concentration of ~400 ppm in air to ~200ppm in the exit flow (50% capture rate).

[0112] 2. Reservoir: contains a mixed solution of NaOH and Na_2CO_3 , the concentration of NaOH can vary from, for example, 1 to 5M and the corresponding concentration of Na_2CO_3 can vary from, for example, 2.5M to 0.2M depending on the ambient temperature, see Table 4. Note: At low NaOH concentrations the contactor loses water to the air and at sufficiently high concentrations it absorbs water. Therefore, in some embodiments, to minimize water loss one may vary the NaOH concentration so as to minimize or eliminate the need for make-up water.

[0113] HX: Heat Exchanger/Heat pump. Note: In practice, for example, a combination of heat exchanger and an ammonia type heat pump may be integrated so as to minimize energy and capital costs.

[0114] 3. Sodium carbonate decahydrate extraction: in this unit, sodium carbonate decahydrate, $\text{Na}_2\text{CO}_3 \cdot 10\text{H}_2\text{O}$, can be separated from a closely saturated solution of Na_2CO_3 -NaOH, by a temperature swing which forces crystallization of the decahydrate. Various types of crystallization units can be used, including a draft tube baffle crystallizer or a fluidized pellet bed reactor known as a "crystalactor". Pure, almost alkaline-free salt can be produced with moisture content of only 5-10% after atmospheric drying. Note: The size of the required temperature swing depends

on 1) the reservoir operating temperature, and 2) the reservoir operating carbonate concentration. Lower temperature swings are needed as the operating temperature rises. Running the reservoir with carbonate close to saturation minimizes the energy required for the temperature swing, but if the concentration is too close to saturation there can be carbonate precipitation in the contactor.

[0115] 4. Dissolving/crystallization/leaching: this is a hybrid unit in which: crystals of sodium carbonate decahydrate are dissolved in warm water to a total concentration of ~30%wt providing a pH level of about 12,

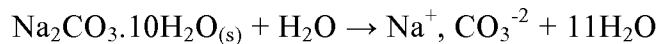

sodium hydroxide is leached from the added sodium penta-titanate, NT5,

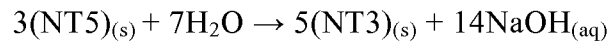

anhydrous sodium carbonate is precipitated due to presence of sodium hydroxide in 4.2 which can decrease the solubility of sodium carbonate.

[0116] E: Evaporative unit: for further crystallization of sodium carbonate to concentrations < 0.75M and for balancing the amount of water produced when dissolving sodium carbonate decahydrate. In some embodiments, this unit might use osmosis rather than evaporation. If evaporation is used, heat recovery can be maximized

[0117] HX: Heat Exchanger.

[0118] 5. Decarbonization reactor or kiln: is the main component of the decarbonization system where separated anhydrous sodium carbonate reacts in a fluidized bed type reactor with the decarbonizing agent (sodium tri-titanate, NT3) via the following reaction and CO₂ is liberated as a pure stream.

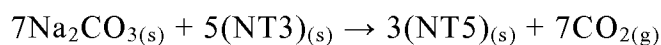

[0119] Several kiln configurations are possible including, for example, (a) indirect natural gas firing with no CO₂ recovery from the natural gas, (b) natural gas or coal syngas with oxy-fuel, and (c) indirect heat from a High Temperature Gas Cooled Reactor (e.g., PBMR). The choice of kiln depends on the size of the titanate particles. Possibilities include flash calcination, fluidized bed and the 'D' kiln

falling particle designs.

[0120] Table 4: Concentration range for the streams from reservoir and to the first crystallization unit:

Ambient T (°C)	NaOH concentration in reservoir (mol/L)	Maximum Carbonate Concentration in (mol/L)	T swing (ΔT , °C)	Carbonate Concentration out (mol/L)	Precipitated carbonate (ΔC)
30	5	0.9	20	0.42	0.48
25	5	0.85	15	0.42	0.43
20	3	1	10	0.55	0.45
	5	0.75		0.42	0.33
15	3	0.75	5	0.55	0.2
	5	0.55		0.42	0.13

[0121] Modified original method: separate leaching and crystallization (as shown in Fig. 9).

[0122] Blocks 1, 2, 3 and 5 in Fig. 9, are identical to the corresponding blocks in Fig. 8. Blocks 4 and 6 are described as below:

[0123] 4. Anhydrous sodium carbonate extraction: Anhydrous sodium carbonate can be extracted via various techniques such as:

[0124] 4.1. Thermal decomposition of solid sodium carbonate decahydrate to anhydrous sodium carbonate and water vapor.

[0125] 4.2. Dissolving solid sodium carbonate decahydrate in water, and crystallizing sodium carbonate monohydrate at elevated temperature followed by thermal decomposition of sodium carbonate monohydrate crystals.

[0126] 4.3. Dissolving sodium carbonate decahydrate in water, processing it through an osmosis process from which clean water is separated from sodium carbonate aqueous solution. The water can be used in leaching unit 6. In some embodiments, separated sodium carbonate solution can go to an evaporative crystallization where anhydrous sodium carbonate can be crystallized.

[0127] 6. Leaching: in this unit sodium hydroxide is leached out from sodium pentatitanate, NT5, by the water that was separated from evaporation/osmosis process in unit 4.

[0128] *Other non-limiting options*

[0129] Potassium: Air capture may also be achieved with potassium solution. KOH has a rate constant for capturing CO₂ from air that, in some conditions, may be approximately twice as large as that for NaOH. This might substantially lower the cost of the contactor. It is not possible to use the conventional calcium causticization cycle for potassium carbonate, but it is possible to use a titanate process. Therefore, the methods disclosed herein may be used with any air capture process based on KOH with titanate caustic recovery.

[0130] In some embodiments, other air capture process which sequester CO₂ through reaction with NaOH may be utilized with the methods described herein. Non-limiting examples of air capture processes include those which use NaOH in a concentration between 1-5 M. The Na₂CO₃ formed through the reaction of CO₂ and NaOH may be extracted using, for example, a two-step extraction method. Non-limiting examples of extraction methods include temperature swings which lead to a solubility swing. In some embodiments, a solubility swing can be induced either through the introduction of NaOH or an increase in pressure. In some embodiments, a fluidized pellet reactor or crystalactor can be used to produce larger crystals which can facilitate separation of Na₂CO₃ while reducing liquid carry-over.

[0131] In some embodiments, the decarbonization process can be performed at temperatures slightly below melting point of anhydrous sodium carbonate, ~850°C, or at temperatures slightly above melting point of anhydrous sodium carbonate, ~860°C.

[0132] In some embodiments, leaching of the regenerated NaOH in a concentrated solution from sodium pentatitanate can be performed using water at ~100°C. In other embodiments, a mixture of sodium hydroxide and carbonate

solution is leached from a reservoir tank at a temperature of ~100°C.

[0133] A method of carbon dioxide capture is also disclosed. In a step (a), a gas containing carbon dioxide is scrubbed with an aqueous solution of an alkali metal hydroxide to react the carbon dioxide to form a first aqueous solution containing an alkali metal carbonate. In a step (b), anhydrous alkali metal carbonate is separated from the first aqueous solution. In a step (c) the anhydrous alkali metal carbonate is treated by causticization to generate carbon dioxide and alkali metal hydroxide. In some embodiments, the alkali metal comprises at least one alkali metal. In some embodiments, the alkali metal hydroxide comprises potassium hydroxide. This way, for example, a potassium system may be used instead of, or in combination with, a sodium system. In some embodiments, the alkali metal hydroxide comprises sodium hydroxide. In some embodiments, step (c) further comprises treating the anhydrous alkali metal carbonate by causticization with an alkali metal tri-titanate to generate carbon dioxide and alkali metal hydroxide. The alkali metal of the alkali metal tri-titanate may comprise at least one alkali metal. In some embodiments, the alkali metal tri-titanate may comprise sodium tri-titanate.

[0134] *Influence of temperature*

[0135] As shown in Figure 16, at 1000°C a second weight loss is observed which, according to literature, is due to reaction [13]:

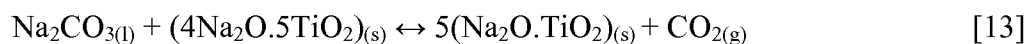

As stated earlier (Zou, 1991), this reaction does not occur at temperatures below 1000°C in presence of CO₂.

[0136] *Influence of steam*

[0137] The effect of steam on decarbonization reaction [4] at 900°C and 1000°C was studied in 20 and 60% steam in the reaction atmosphere. These studies concluded that the presence of steam does not significantly affect the reaction. Figure 17 shows the effect of steam at 900°C. As is shown, the presence of steam slightly lowers the temperature at which the reaction starts. Reports in the literature, on the other hand, have reported complete decarbonization conversion is possible under steam gasification

of black liquor at 715°C and in the presence of 5% or less CO₂ in the gas phase. These studies, therefore suggest implementation of a steam reformer in direct causticization-gasification processes to maintain a low concentration of CO₂ in the gas phase.

[0138] Although the presence of steam lowers the temperature at which the reaction starts, Figure 17(a), it decreases the final conversion of reaction by about 2%. At higher temperatures, e.g. 1000°C as in Figure 17(b), the presence of steam does not significantly change the temperature at which the reaction starts. Figure 17(b), however, shows that the second weight loss due to reaction [13] at 1000°C is hindered in presence of steam.

[0139] *Influence of CO₂*

[0140] As shown in Figure 18(a) and 18(b), the effect of CO₂ on decarbonization reaction [4] at two different temperatures, 900°C and 1000°C is illustrated.

[0141] In the absence of CO₂ at 900°C (Figure 18(a)), the reaction starts at about 700°C which is in agreement with earlier studies and it goes to completion within a few minutes as the temperature approaches about 850°C. In higher partial pressure of CO₂, however, the reaction starts at higher temperature, e.g. in 30% CO₂ the reaction starts at about 800°C and in 100% CO₂ the reaction does not start until about 900°C. Without being bound by theory, this may imply that at higher concentrations of CO₂, dissociation reaction [1]:



is shifted to the left which makes sodium carbonate stable at higher temperatures, depending on the concentration of CO₂, this temperature can vary from 800°C to 900°C. In some embodiments, causticization occurs in the presence of at least 10% CO₂. In some embodiments, causticization occurs in the presence of between about 30 and about 50% CO₂.

[0142] *Generating Carbon Credits*

[0143] The carbon that is sequestered from a gas comprising carbon dioxide using the methods described herein can be equated with, for example, an environmental credit such as a carbon credit. Carbon credits are used to provide an incentive to reduce greenhouse gas emissions by capping total annual emissions and letting the market

assign a monetary value to a tradable unit. As used herein, carbon credits include carbon credits as defined by provisions in place at the time of filing but are not limited to such. Carbon credits also refer to any type of tangible or intangible currency, stocks, bonds, notes or other tradable or marketable unit used to value an amount of carbon sequestered, an amount of greenhouse gas emissions reduced, or any other type of carbon-neutral or carbon-negative activities. A similar concept of environmental credits can be applied, for example, for the implementation of best practices related to environmental land practices.

[0144] Carbon credits can be obtained, for example, by applying and receiving certification for the amount of carbon emissions reduced (e.g., the amount of carbon sequestered, the amount of CO₂ and other greenhouse gases not released into the atmosphere). The quality of the credits can be based in part on validation processes and the sophistication of funds or development companies that act as sponsors to carbon projects. See, for example, U.S. Patent Publication Nos. 2002/0173979 and 2007/0073604 for representative methods for verifying and valuing carbon credits. Carbon credits can be exchanged between businesses or bought and sold in national or international markets at a prevailing market price. In addition, companies can sell carbon credits to commercial and individual customers who are interested in voluntarily offsetting their carbon footprints. These companies may, for example, purchase the credits from an investment fund or a carbon development company that has aggregated the credits from individual projects.

[0145] The process of applying for, obtaining and/or validating one or more carbon credits may or may not include taking actual measurements. Simply by way of example, each transfer of carbon credits within Europe is validated by the ETS, and each international transfer is validated by the United Nations Framework Convention on Climate Change (UNFCCC).

[0146] The processes disclosed herein may be tailored to the specific chemical species present in addition to the ones mentioned here. The chemical species refers to, for example, the alkali metal hydroxide, the secondary solute, and any other species dissolved in a solution used herein. Referring to Fig. 4, for example, different alkali metal carbonates would have differently shaped precipitation graphs.

In addition, for these different species, the transition temperature (Fig. 6) and saturation concentrations (Figs. 4 and 5) would have to be adjusted accordingly.

[0147] In the claims, the word "comprising" is used in its inclusive sense and does not exclude other elements being present. The indefinite article "a" before a claim feature does not exclude more than one of the feature being present. As used herein, "about" is meant to account for variations due to experimental error. All measurements reported herein are understood to be modified by the term "about", whether or not the term is explicitly used, unless explicitly stated otherwise. As would be clear to one of ordinary skill in the art, based on the disclosure of the specification, the unit "%wt" is meant to represent weight percent.

[0148] Each one of the individual features described here may be used in one or more embodiments and is not, by virtue only of being described here, to be construed as essential to all embodiments as defined by the claims.

WHAT IS CLAIMED:

1. A method, comprising:
 - (a) separating anhydrous sodium carbonate from a first aqueous solution formed by reacting carbon dioxide and sodium hydroxide; and
 - (b) causticizing the separated anhydrous sodium carbonate to generate carbon dioxide and sodium hydroxide.
2. A method of claim 1, wherein the causticizing comprises:
reacting the anhydrous sodium carbonate with sodium tri-titanate to produce carbon dioxide gas and sodium penta-titanate; and
regenerating sodium hydroxide and sodium tri-titanate from the sodium penta-titanate.
3. A method of claim 2, in which reacting with sodium tri-titanate is carried out at temperatures at or above the melting point of anhydrous sodium carbonate.
4. A method of claim 1, in which the first aqueous solution is formed by scrubbing a gas containing carbon dioxide with an aqueous solution of sodium hydroxide.
5. A method of claim 2, further comprising:
separating additional anhydrous sodium carbonate solution formed by reacting additional carbon dioxide with the sodium hydroxide remaining in the first aqueous solution after the first separation of anhydrous sodium carbonate; and
causticizing the additional anhydrous sodium carbonate to generate carbon dioxide and sodium hydroxide.
6. A method of claim 5, further comprising hydrolyzing the sodium penta-titanate.
7. A method of claim 1, in which separating further comprises:
 - (x) separating a hydrate of sodium carbonate from the first aqueous solution;

- (y) dissolving the hydrate of sodium carbonate in a second aqueous solution and heating the second aqueous solution to a temperature at or above the transition temperature of monohydrate sodium carbonate and anhydrous sodium carbonate precipitation to produce the anhydrous sodium carbonate.
8. A method of claim 7, in which the concentration of sodium carbonate in the first aqueous solution is lower than the concentration of sodium carbonate in the second aqueous solution.
 9. A method of any claim 7, in which separating further comprises cooling the first aqueous solution to separate the hydrate of sodium carbonate from the first aqueous solution.
 10. A method of claim 7, in which the anhydrous sodium carbonate is produced at elevated pressure.
 11. A method of claim 7, in which the hydrate of sodium carbonate comprises sodium carbonate decahydrate.
 12. A method of claim 7, in which the pH of the first aqueous solution is high enough during causticizing to reduce co-crystallization of sodium bicarbonate.
 13. A method of claim 1, in which the causticizing occurs in the presence of at least 10% CO₂.
 14. A method of claim 1 in which the causticizing occurs in the presence of steam.
 15. A method comprising:
 - (a) scrubbing a gas containing carbon dioxide with an aqueous solution of sodium hydroxide to react the carbon dioxide to form a first aqueous solution containing sodium carbonate;
 - (b) separating anhydrous sodium carbonate from the first aqueous solution; and
 - (c) treating the anhydrous sodium carbonate by causticization to generate

- carbon dioxide and sodium hydroxide.
16. A method of claim 15 further comprising: treating the anhydrous sodium carbonate by causticization with sodium tri-titanate to generate carbon dioxide and sodium hydroxide.
17. A method comprising:
- (a) scrubbing a gas containing carbon dioxide with an aqueous solution of alkali metal hydroxide resulting in a first aqueous solution containing alkali metal carbonate;
 - (b) separating anhydrous alkali metal carbonate from the first aqueous solution; and
 - (c) treating the anhydrous alkali metal carbonate by causticization to generate carbon dioxide and alkali metal hydroxide.
18. A method of generating carbon credits comprising:
- (a) scrubbing a gas containing carbon dioxide with an aqueous solution of sodium hydroxide to react the carbon dioxide to form a first aqueous solution containing sodium carbonate;
 - (b) separating anhydrous sodium carbonate from the first aqueous solution;
 - (c) treating the anhydrous sodium carbonate by causticization to generate carbon dioxide and sodium hydroxide thereby generating carbon credits based on the carbon dioxide removed from the gas.

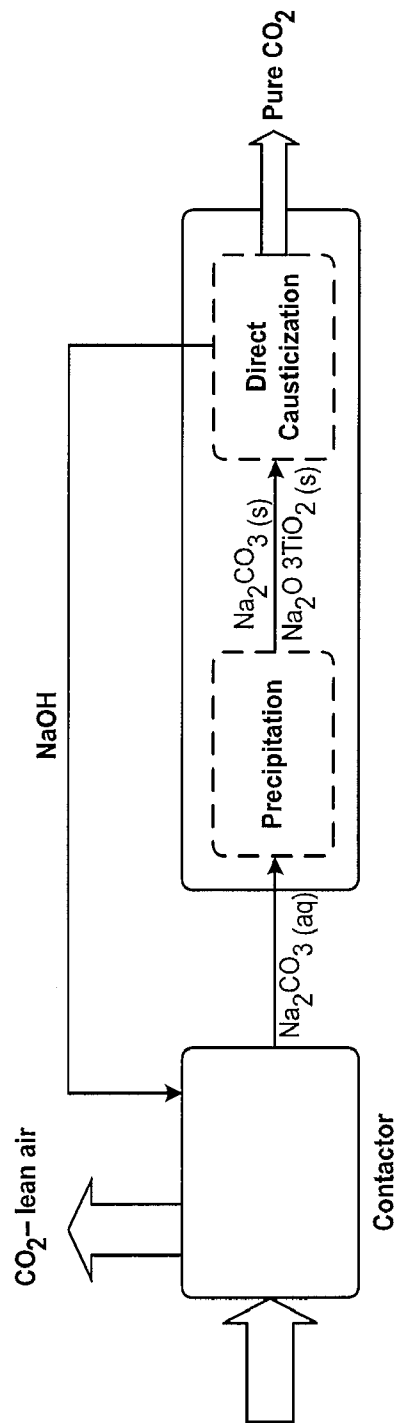

FIG. 1

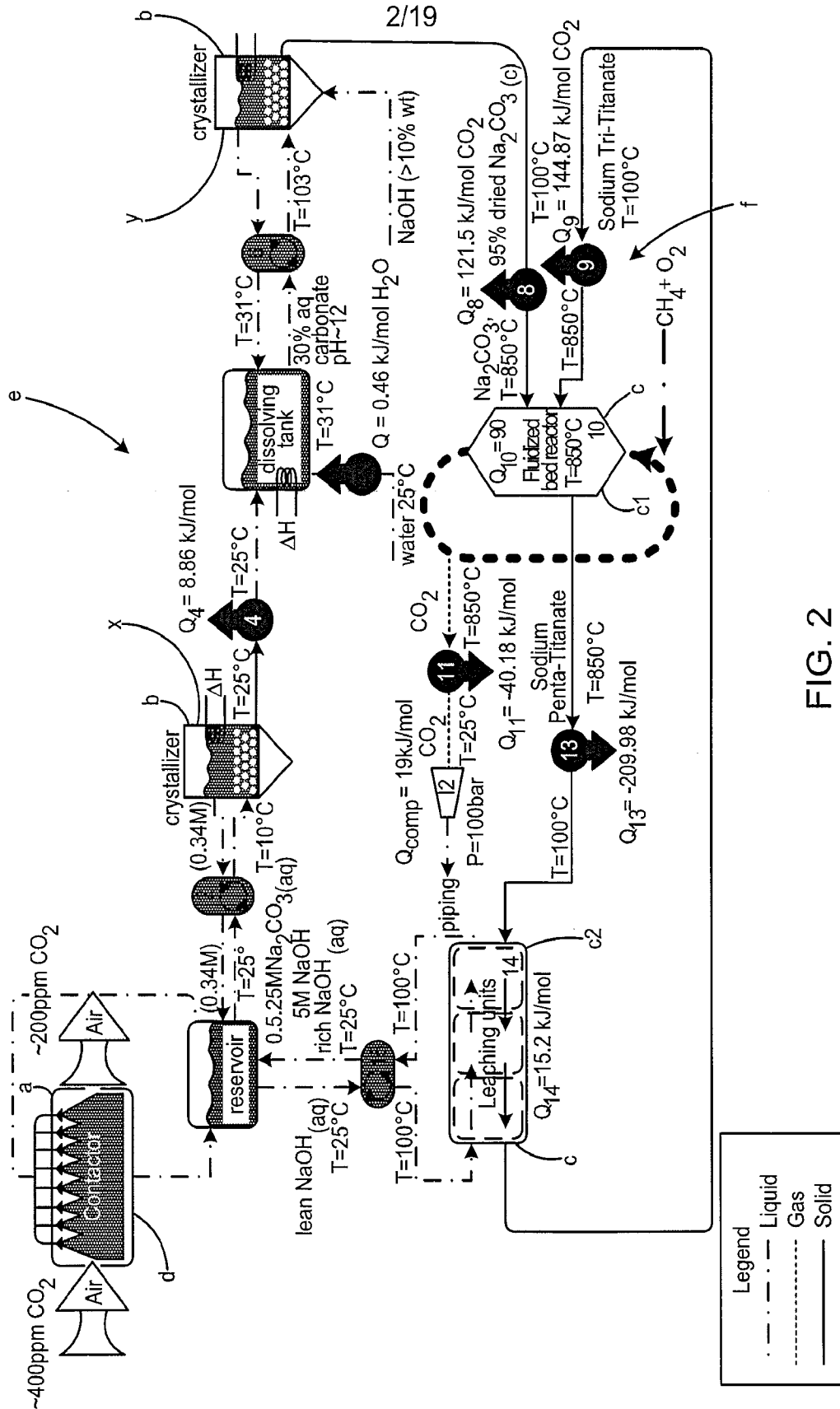

FIG. 2

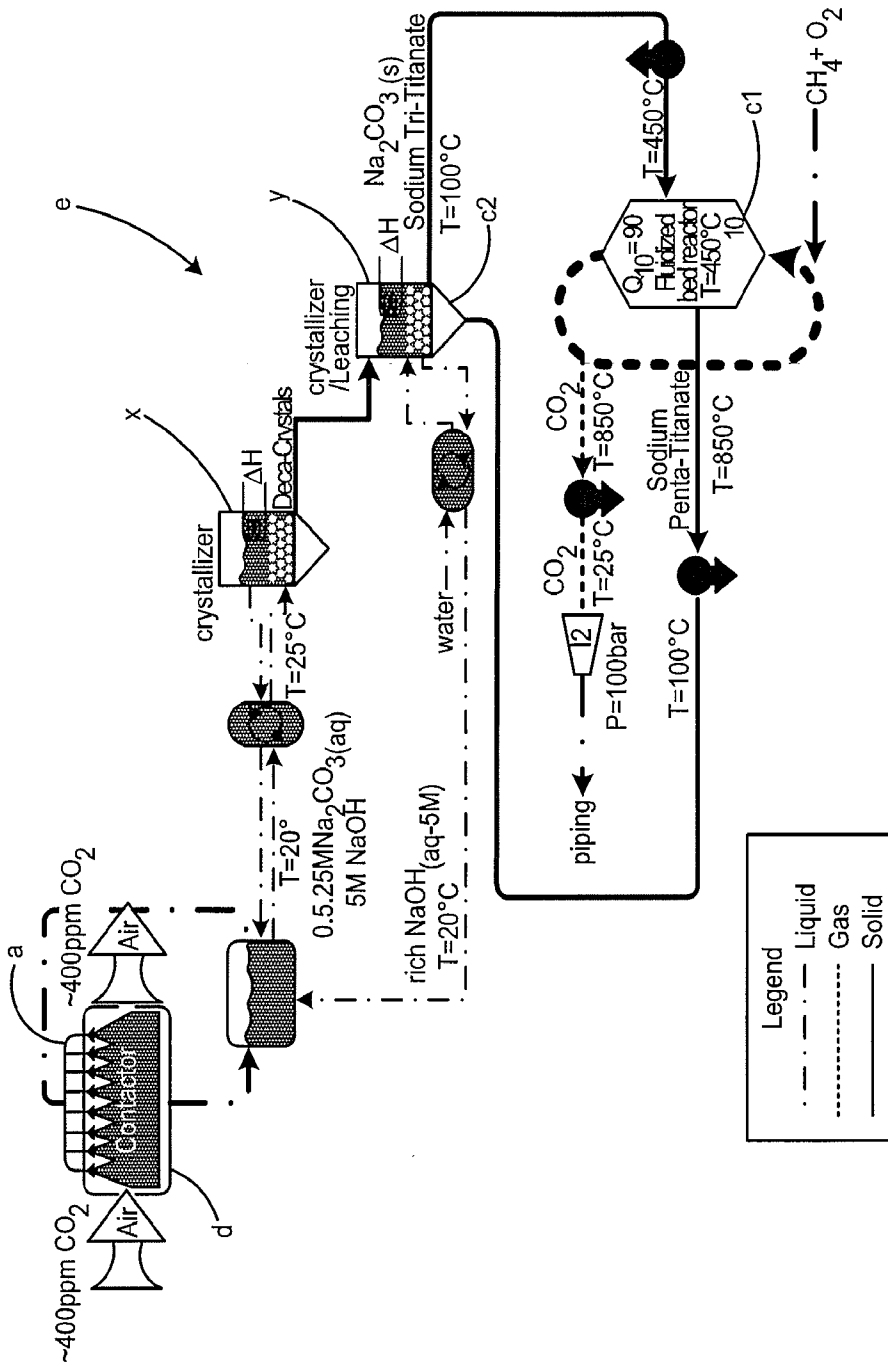

FIG. 3

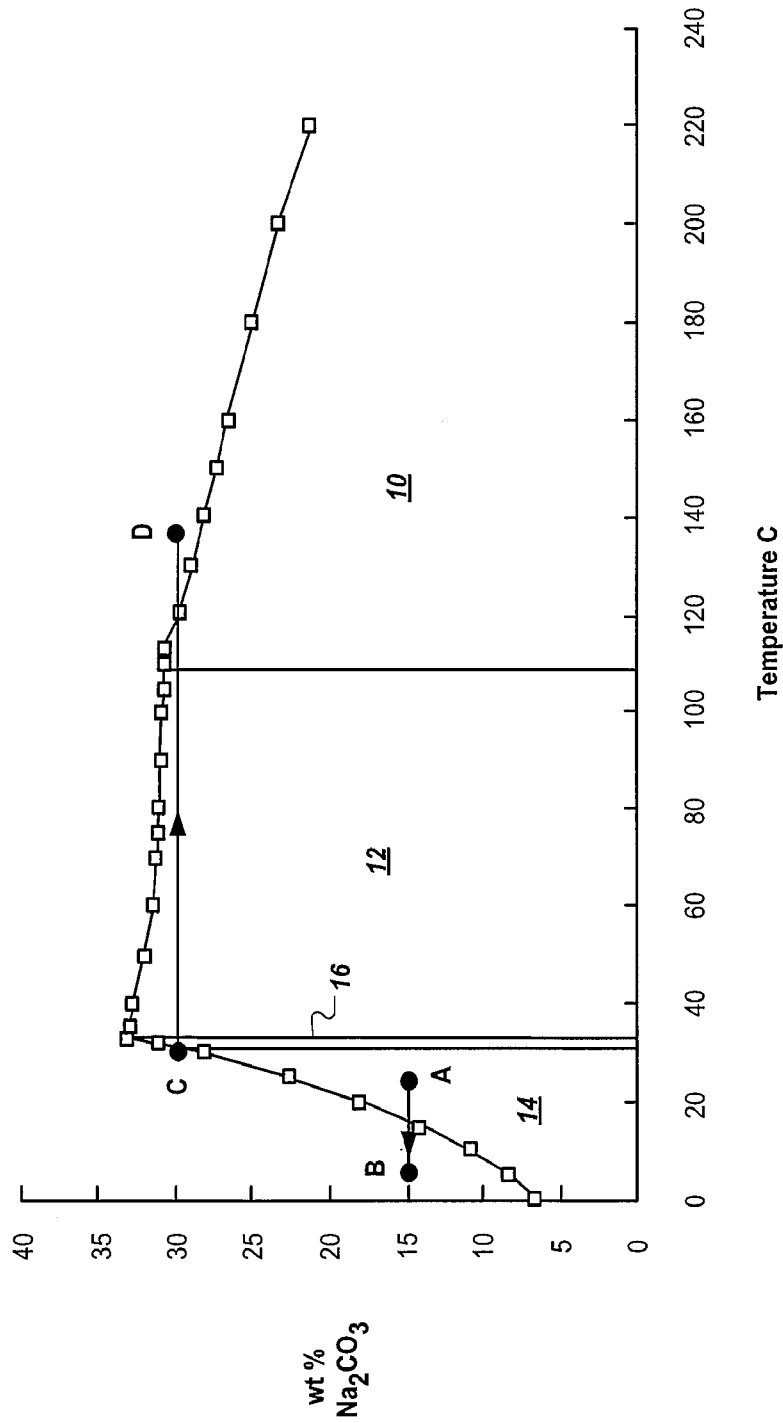

FIG. 4

5/19

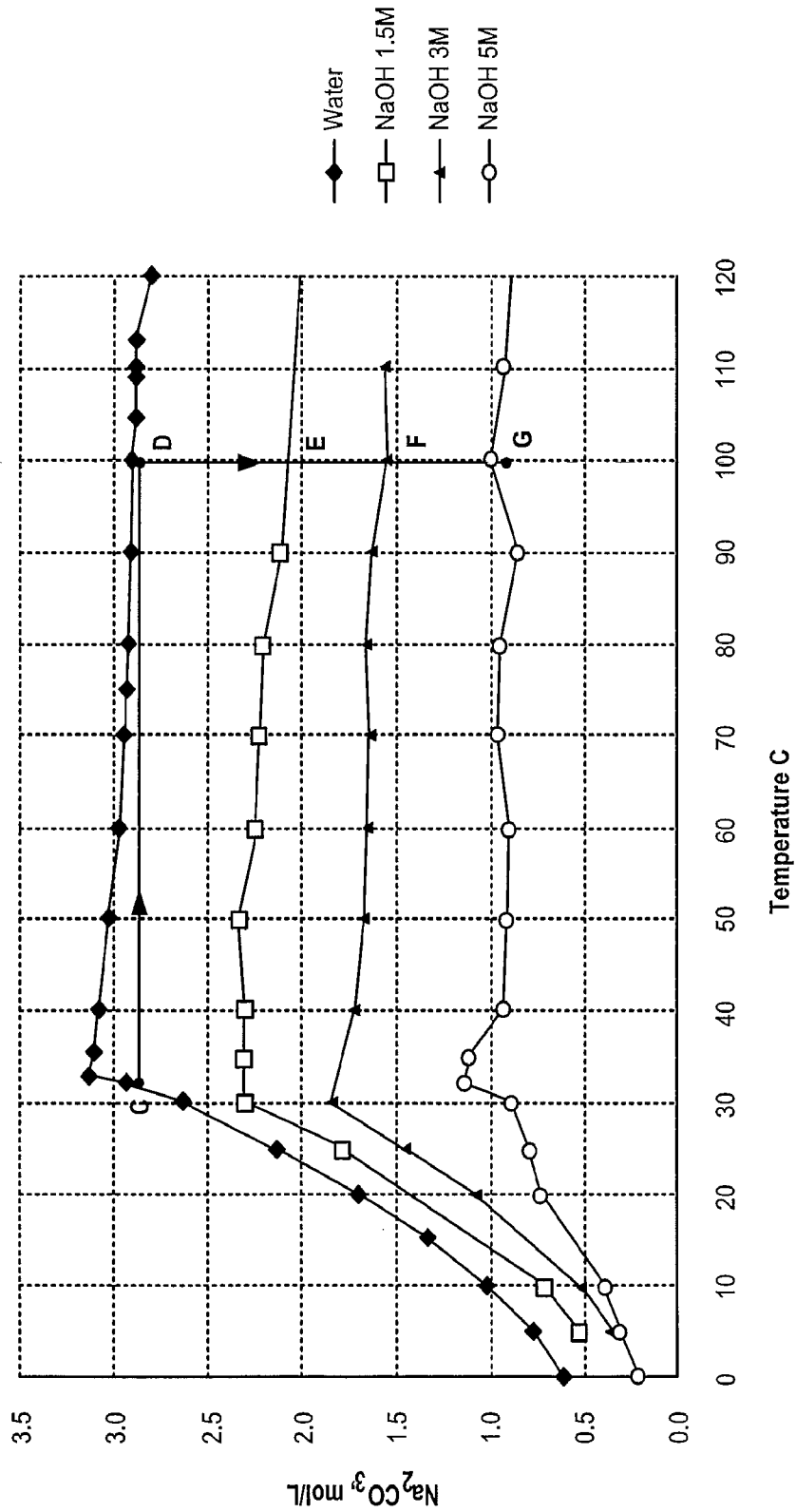

FIG. 5

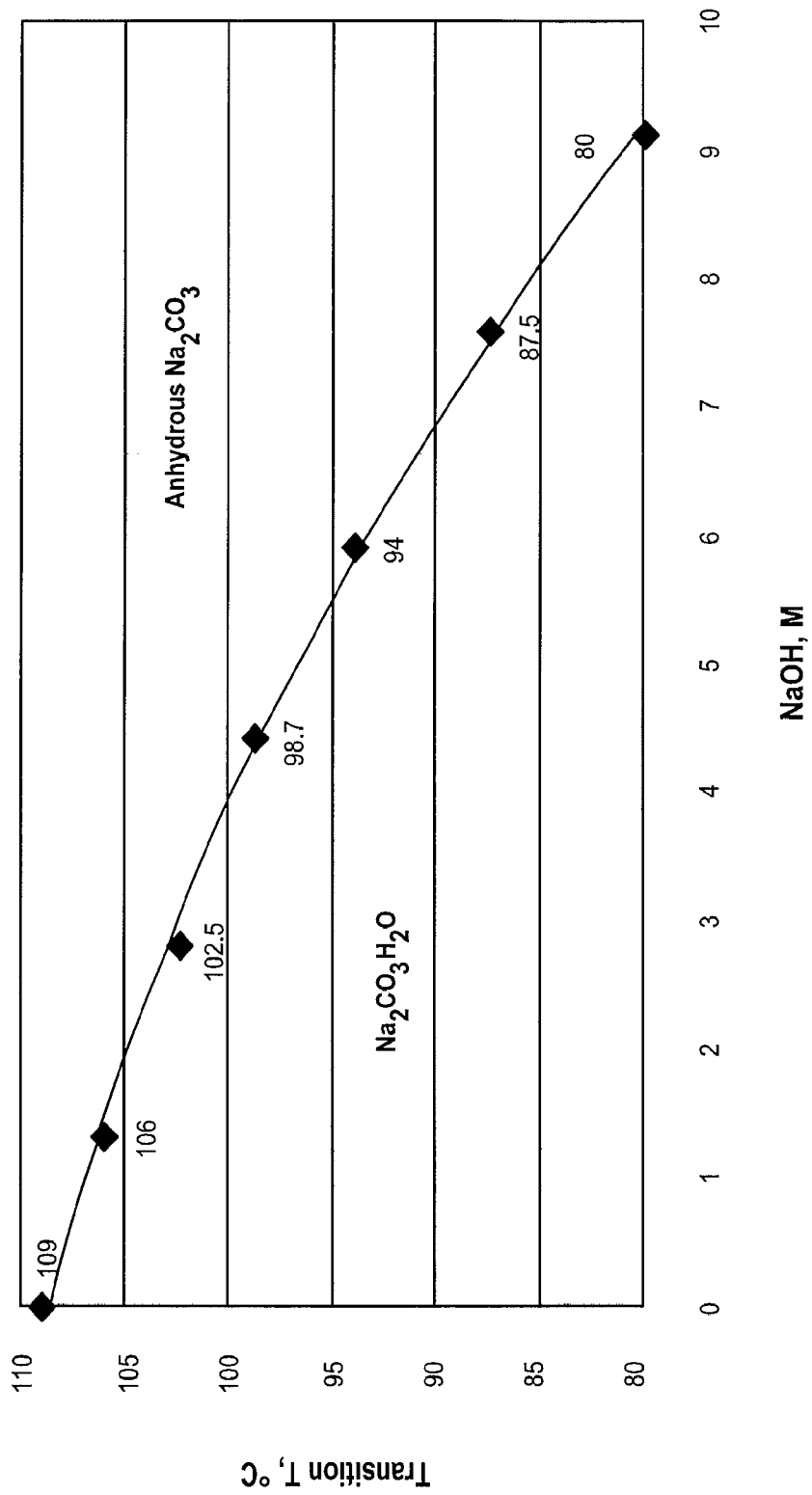

FIG. 6

7/19

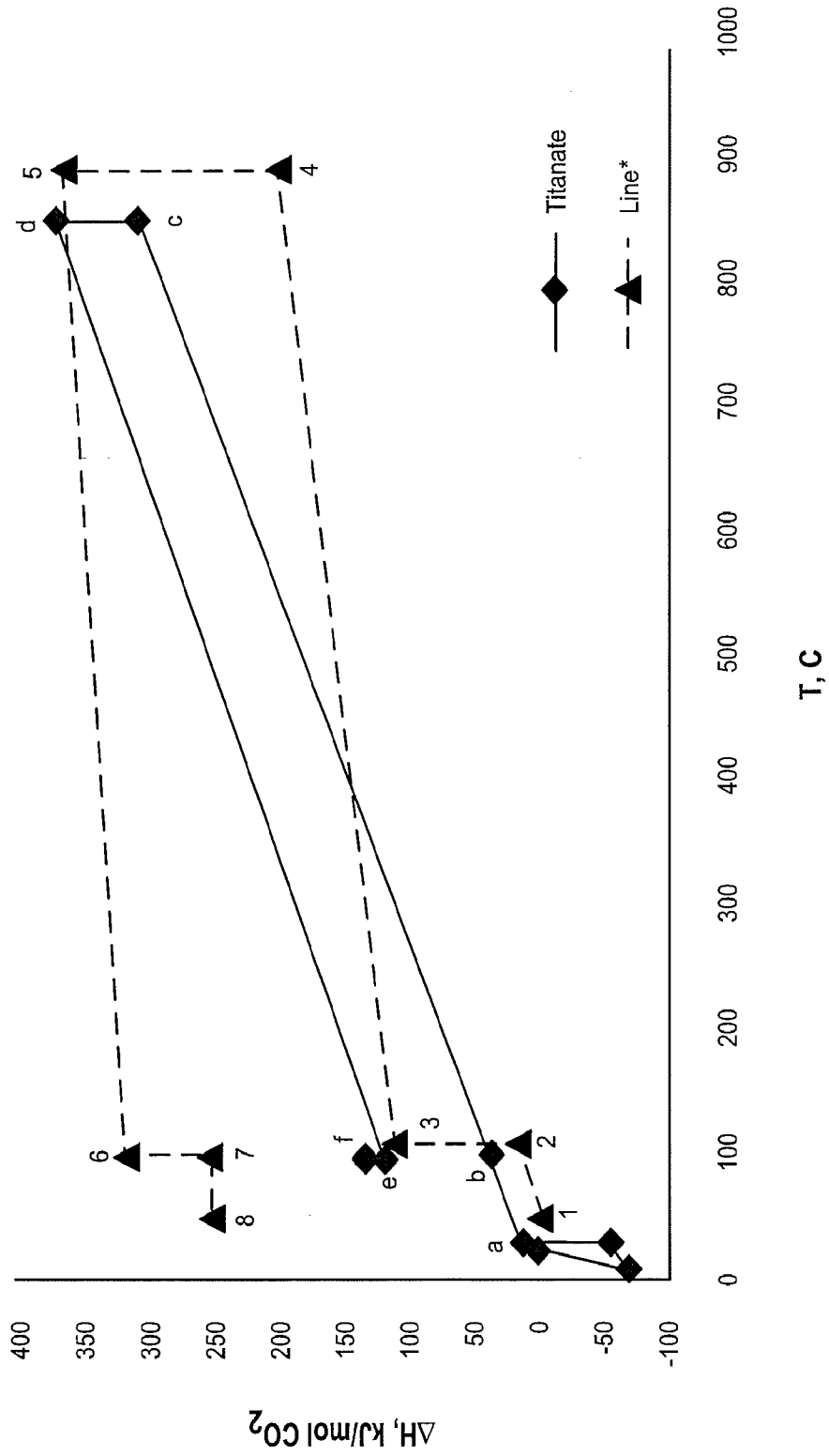

FIG. 7

8/19

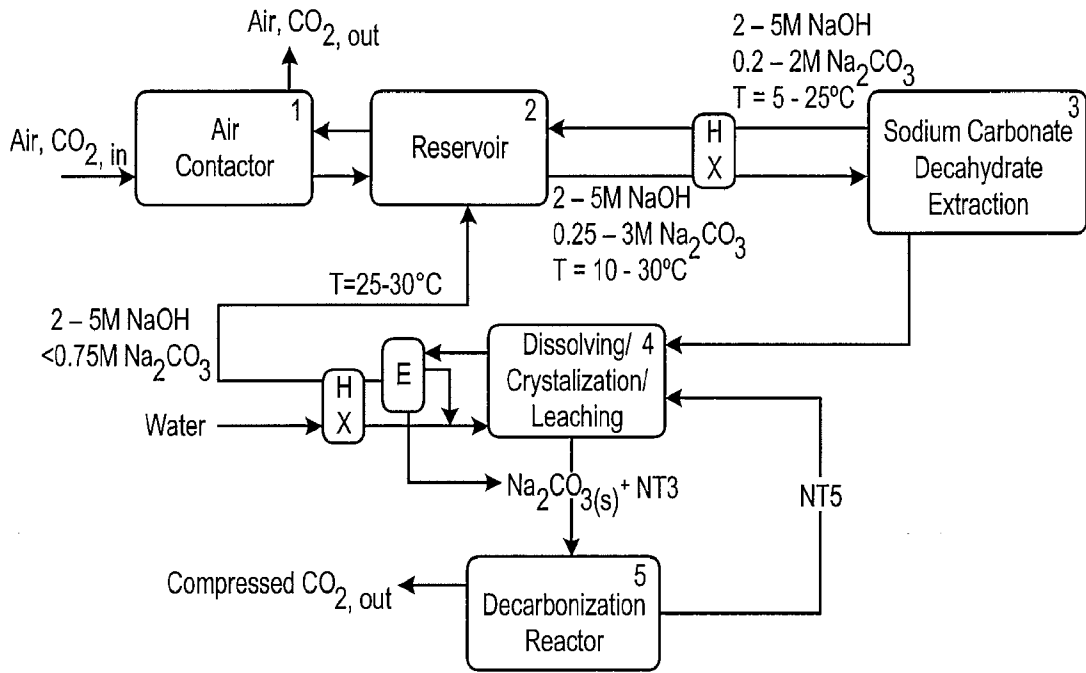

FIG. 8

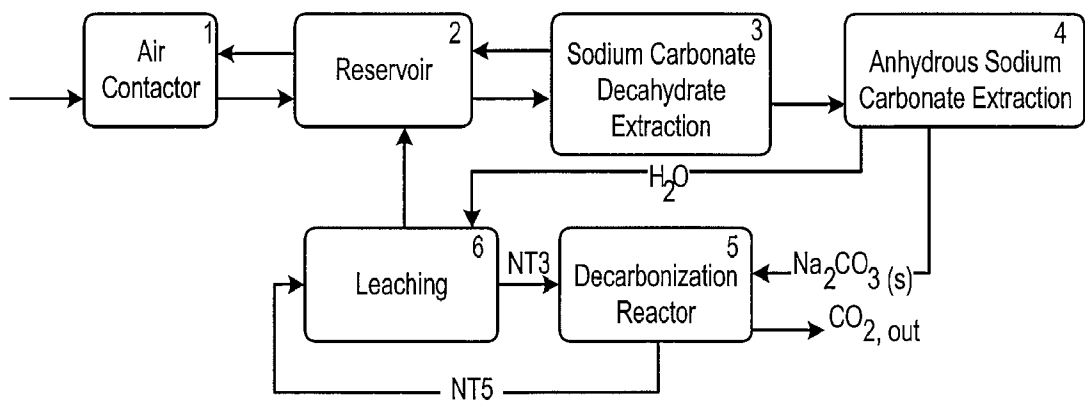

FIG. 9

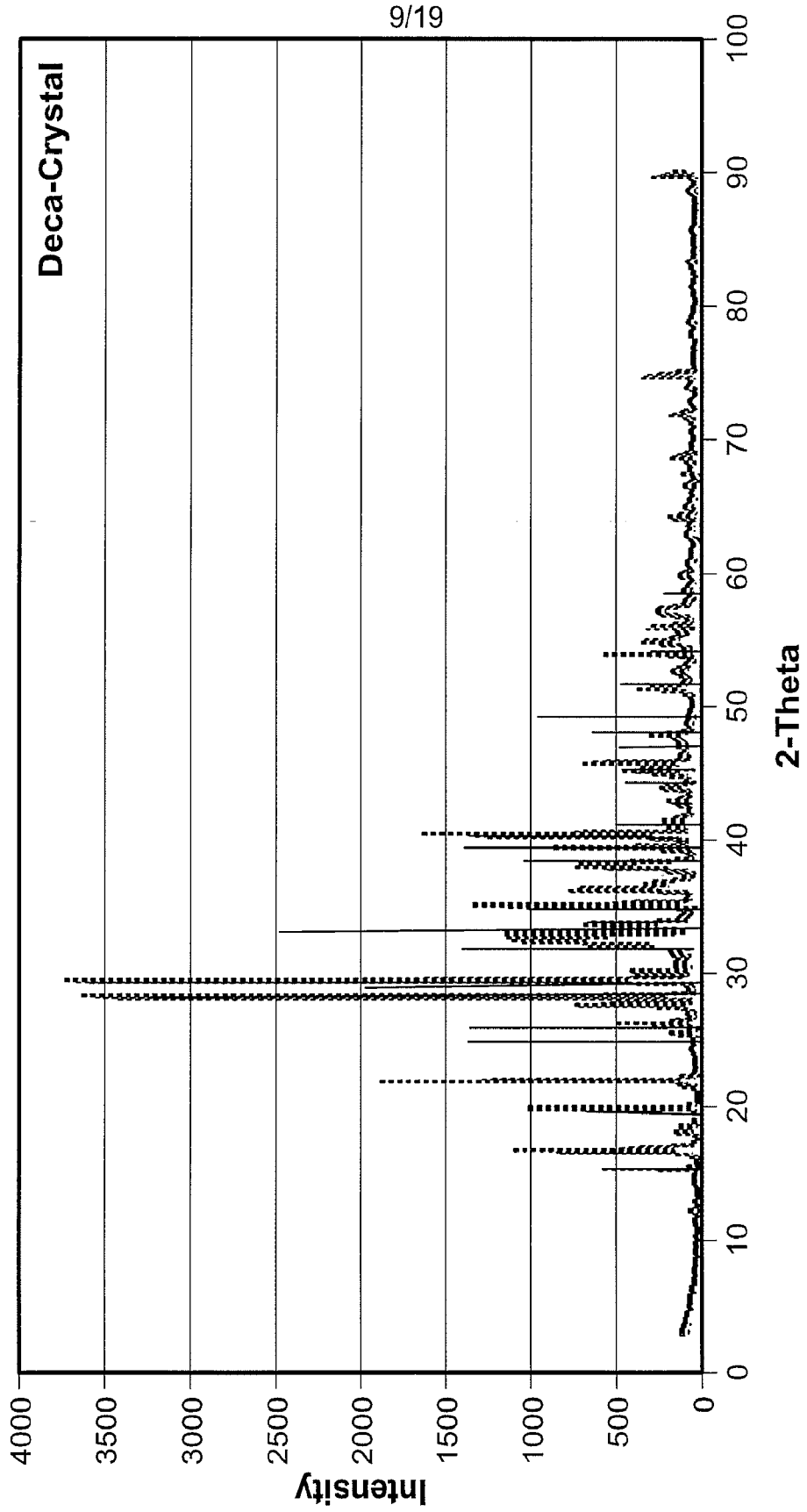

FIG. 10

11/19

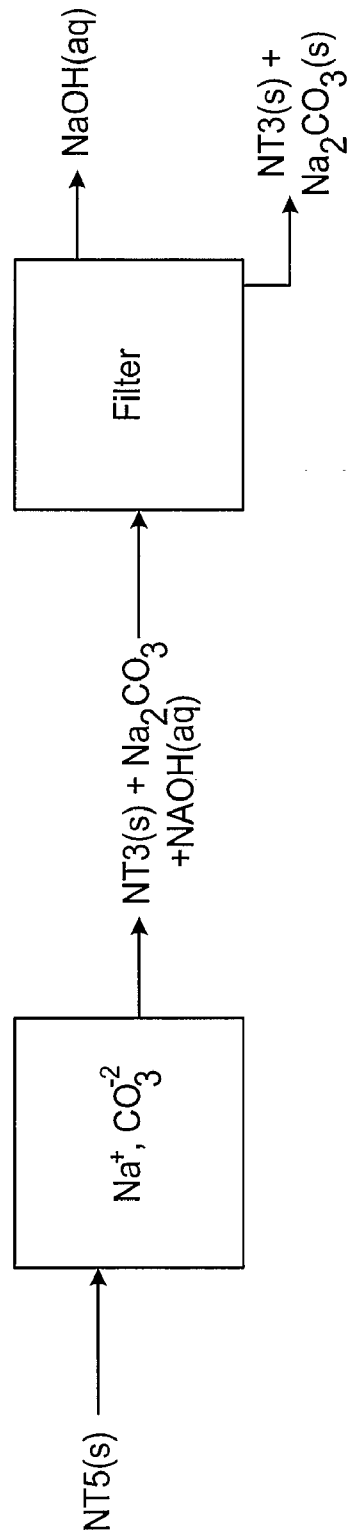
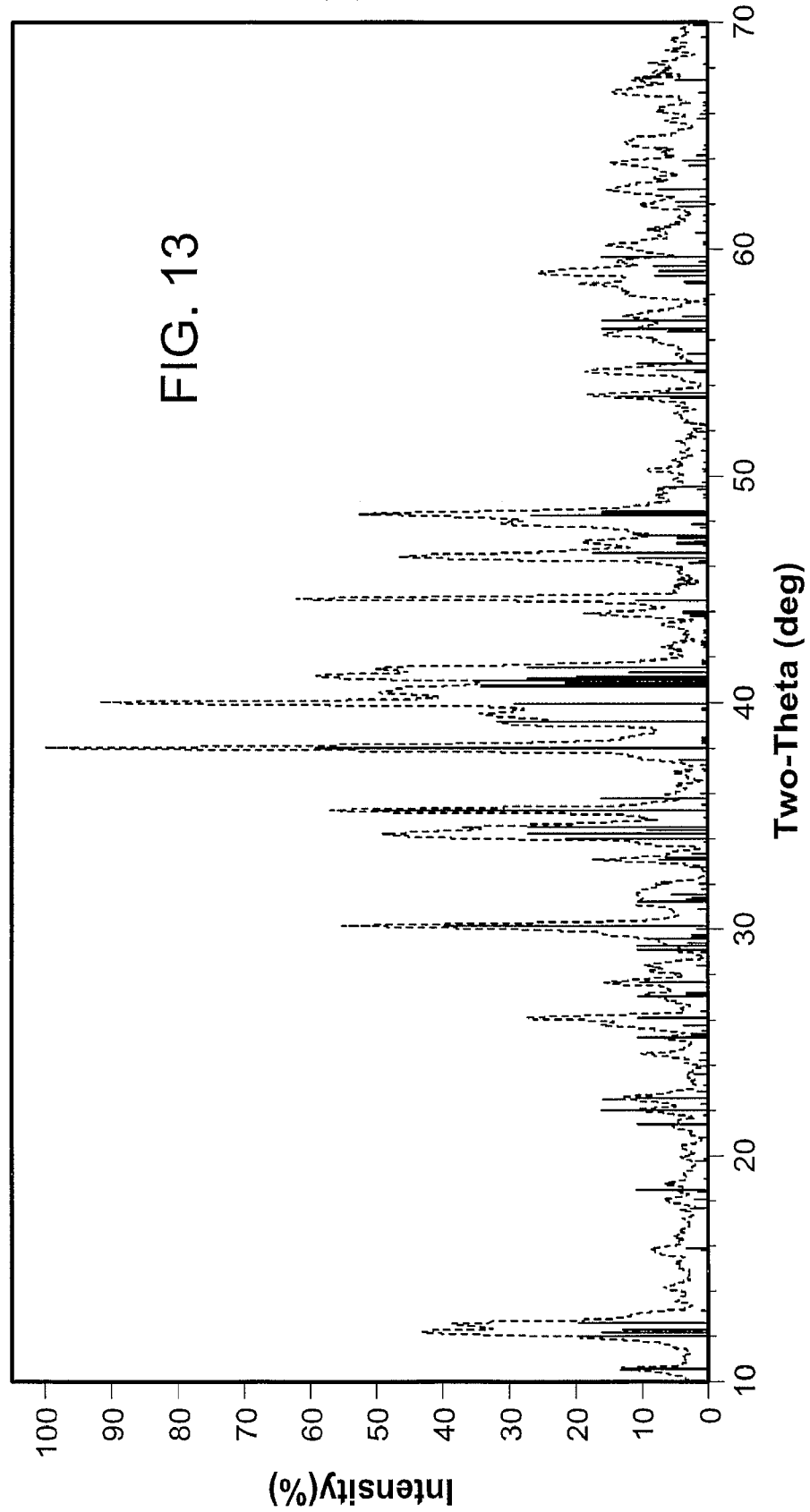
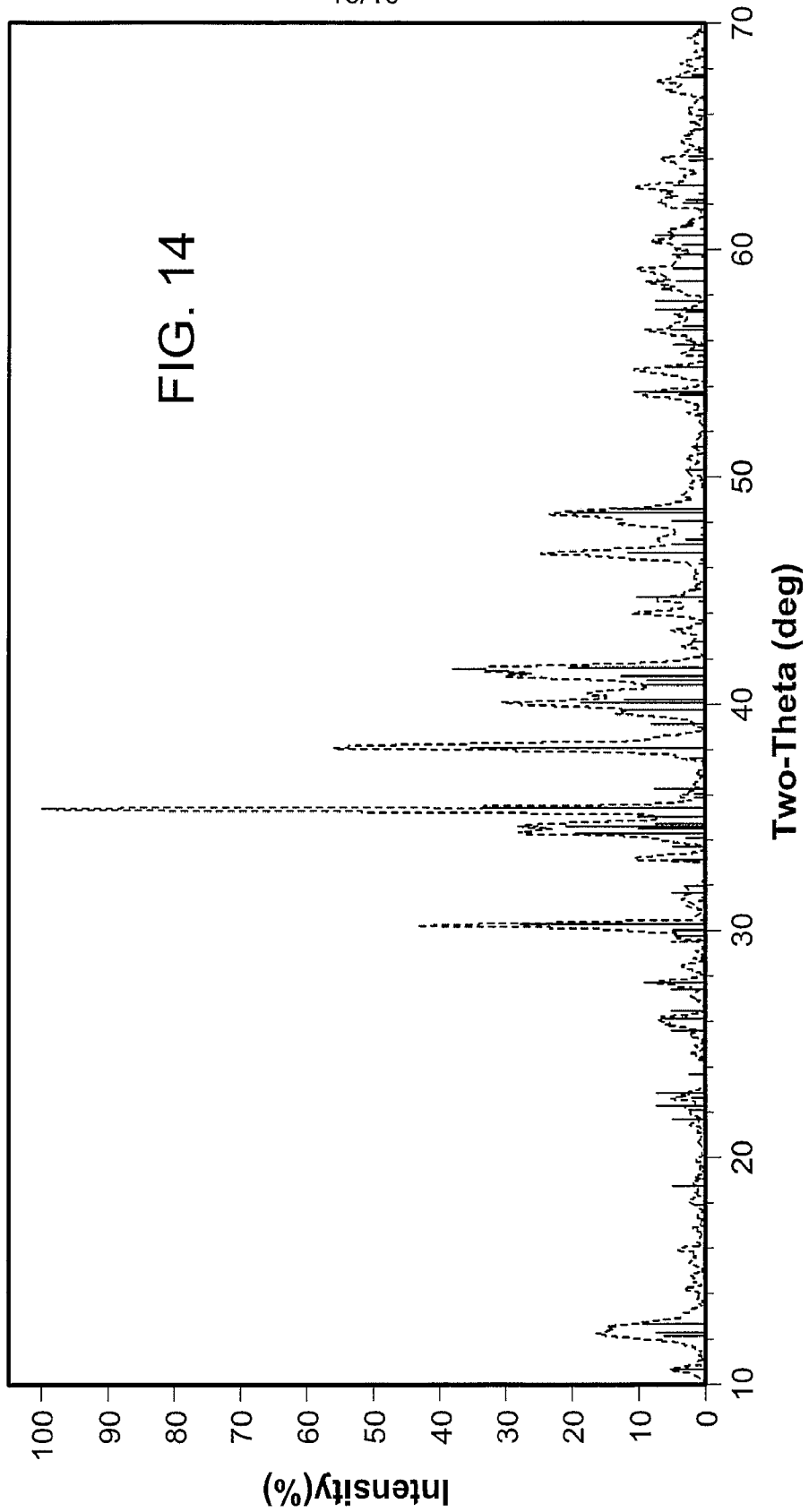

FIG. 12

12/19



13/19



	OH ⁻ , M	CO ₃ , M
Initial	0	3
Measured	2.5956	1.7804
Expected	3	1.6

Calculation based on vol.
 Vol. consumed for CO₃ 2.2 mL
 Vol. consumed for OH 3.3 mL

mol H ₂ SO ₄	mol H ⁺	C-diluted	C-sample
0.00022	0.00044	0.044	1.76
0.00033	0.00033	0.066	2.64

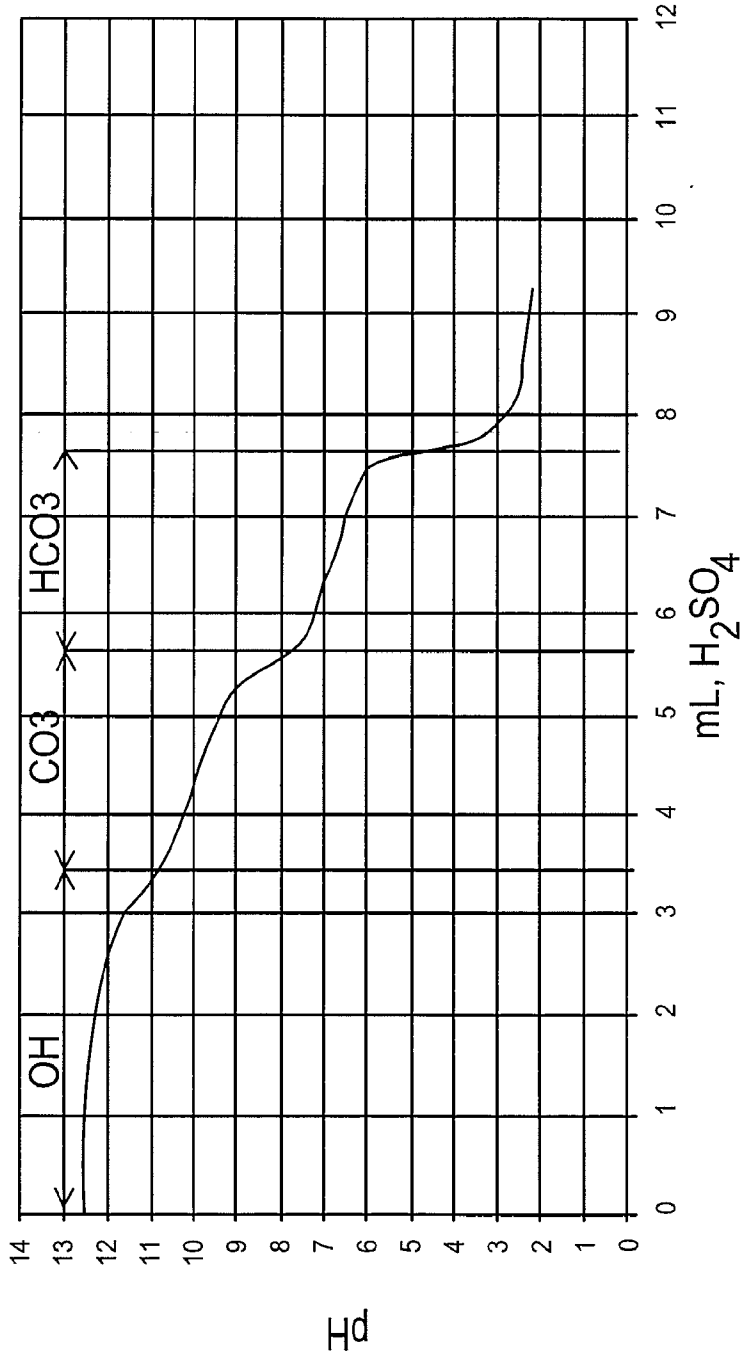

FIG. 15

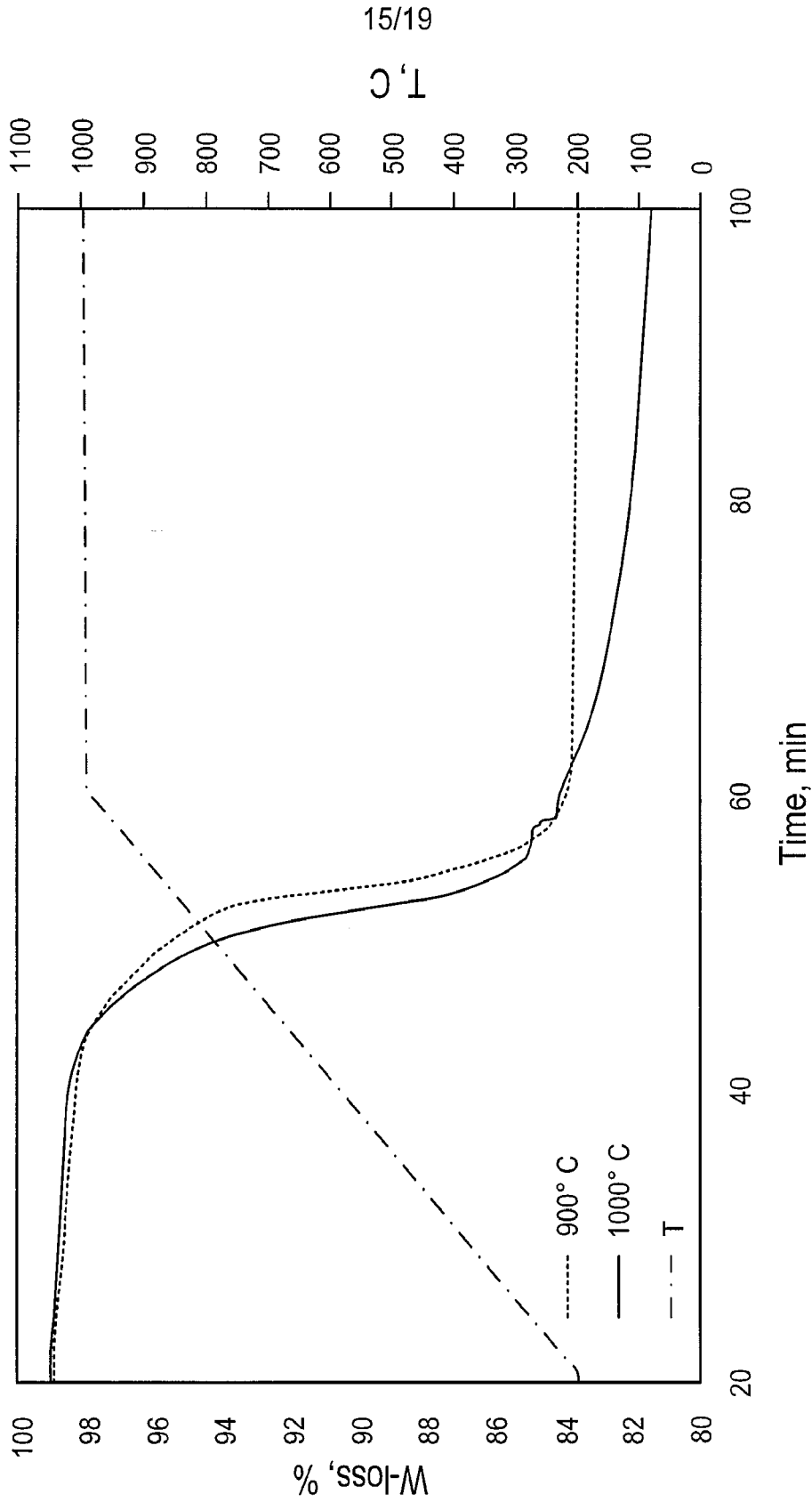

FIG. 16

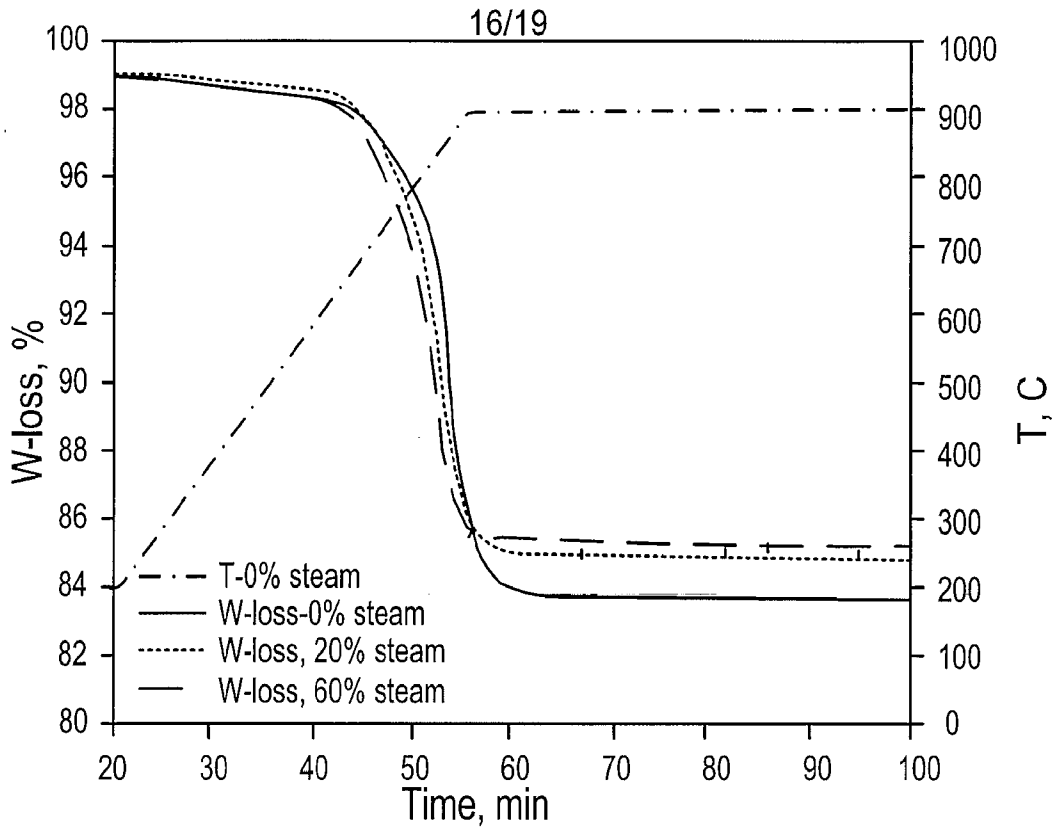

FIG. 17A

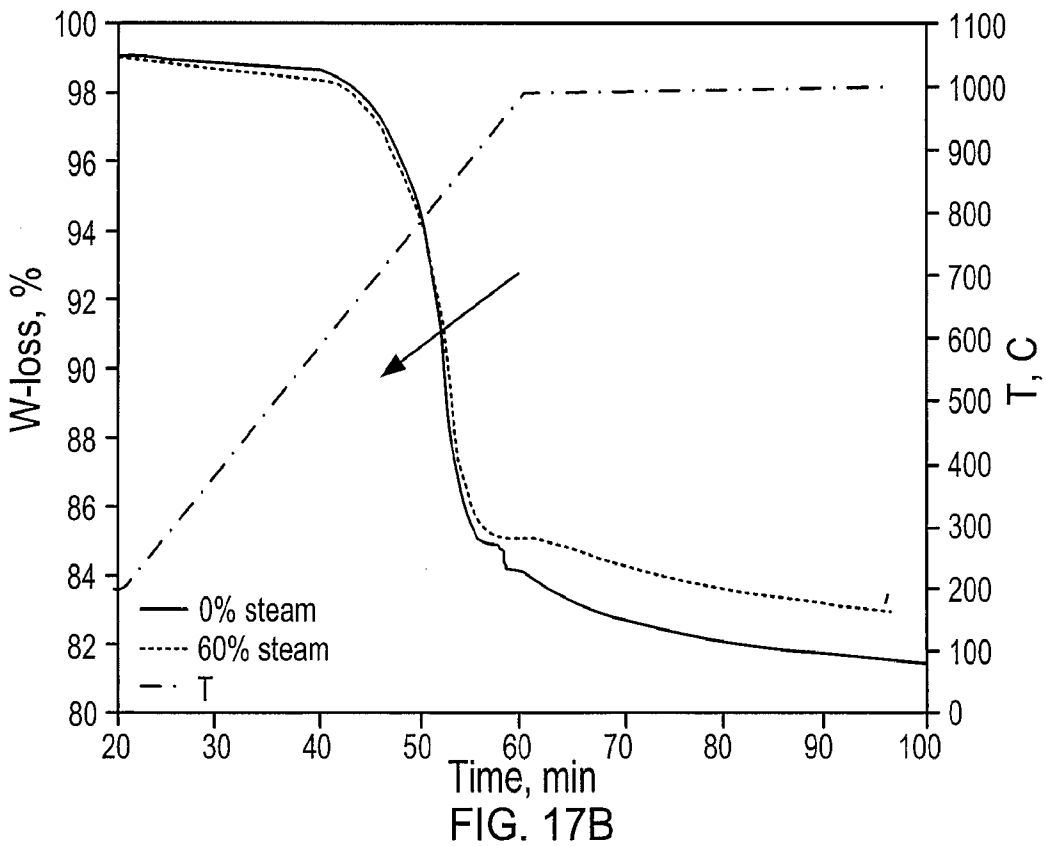

FIG. 17B

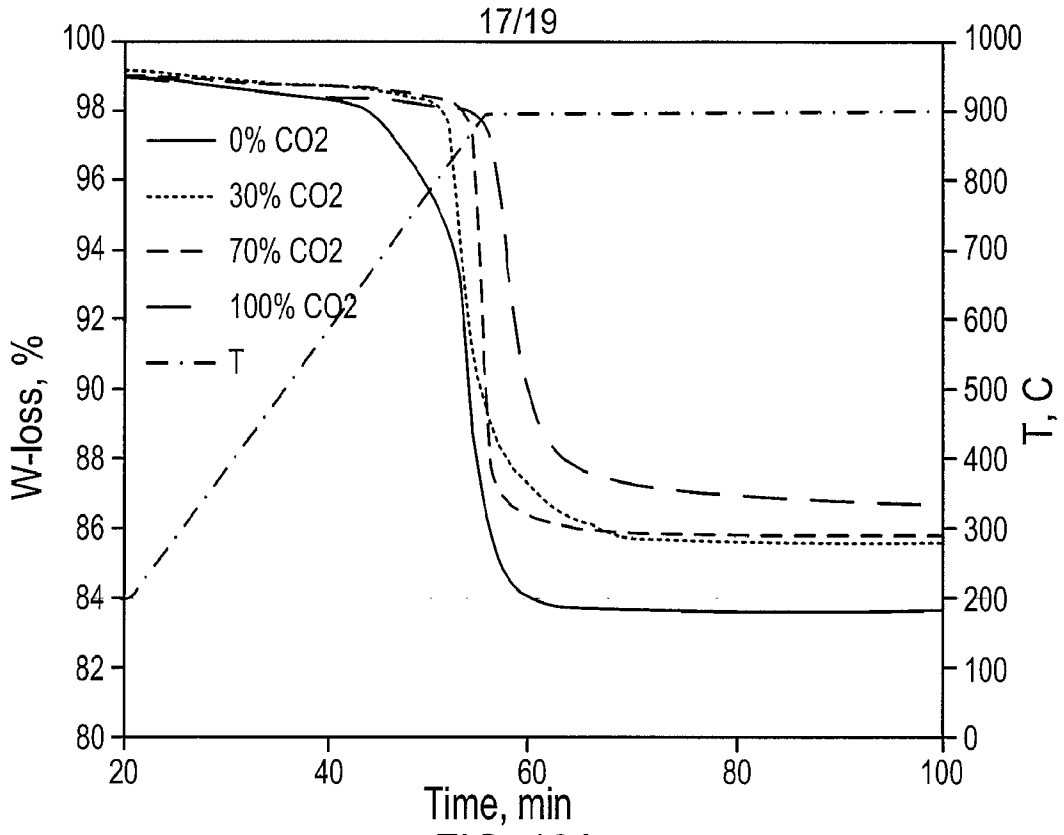

FIG. 18A

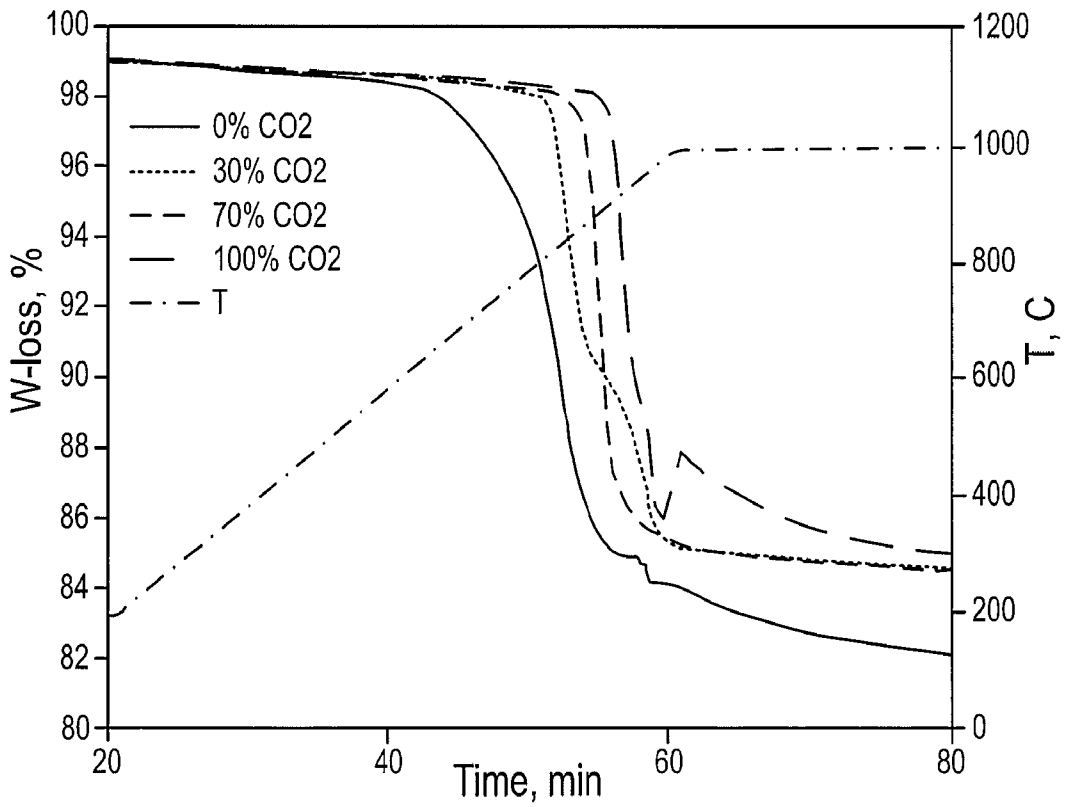

FIG. 18B

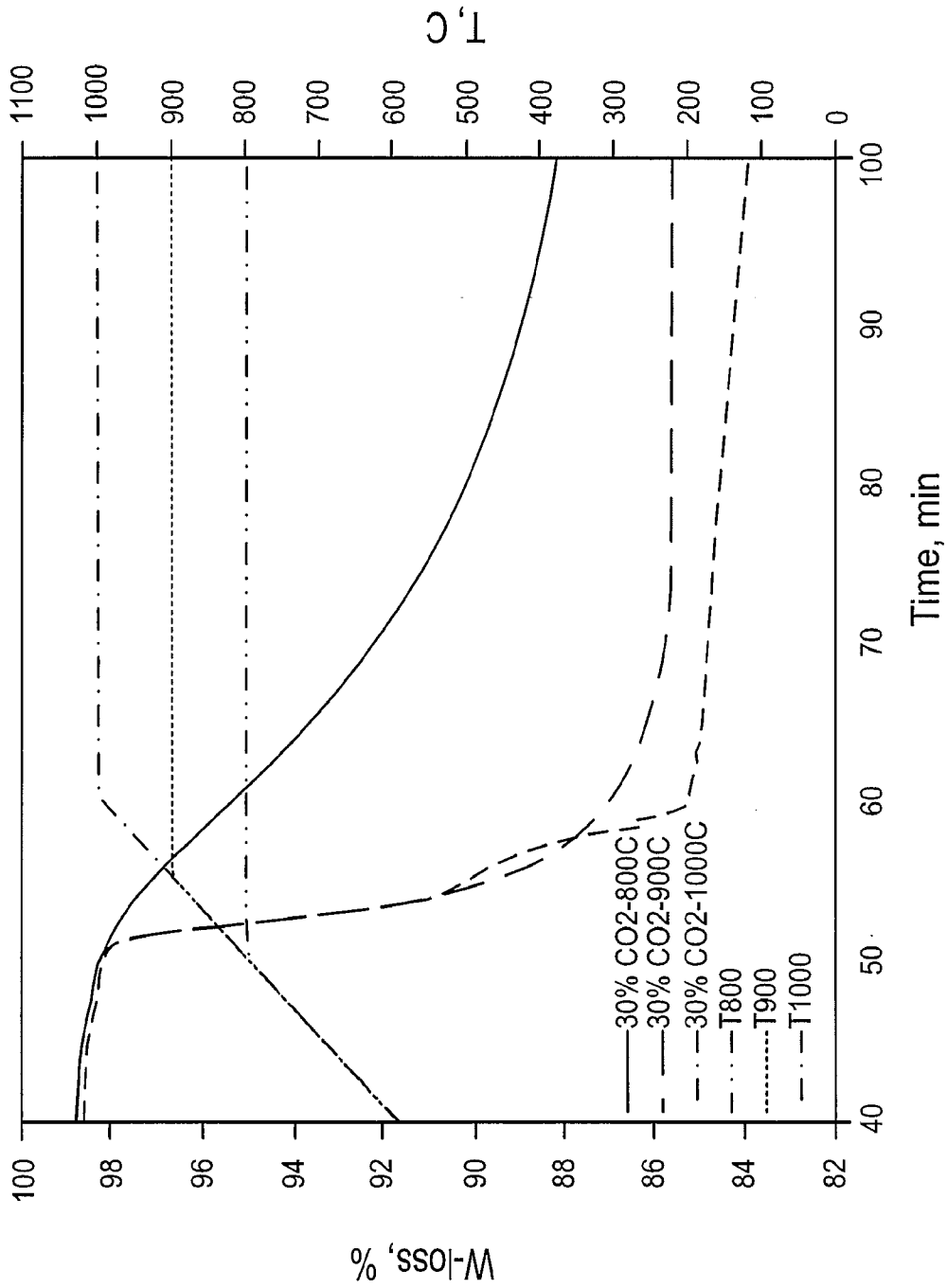

FIG. 19

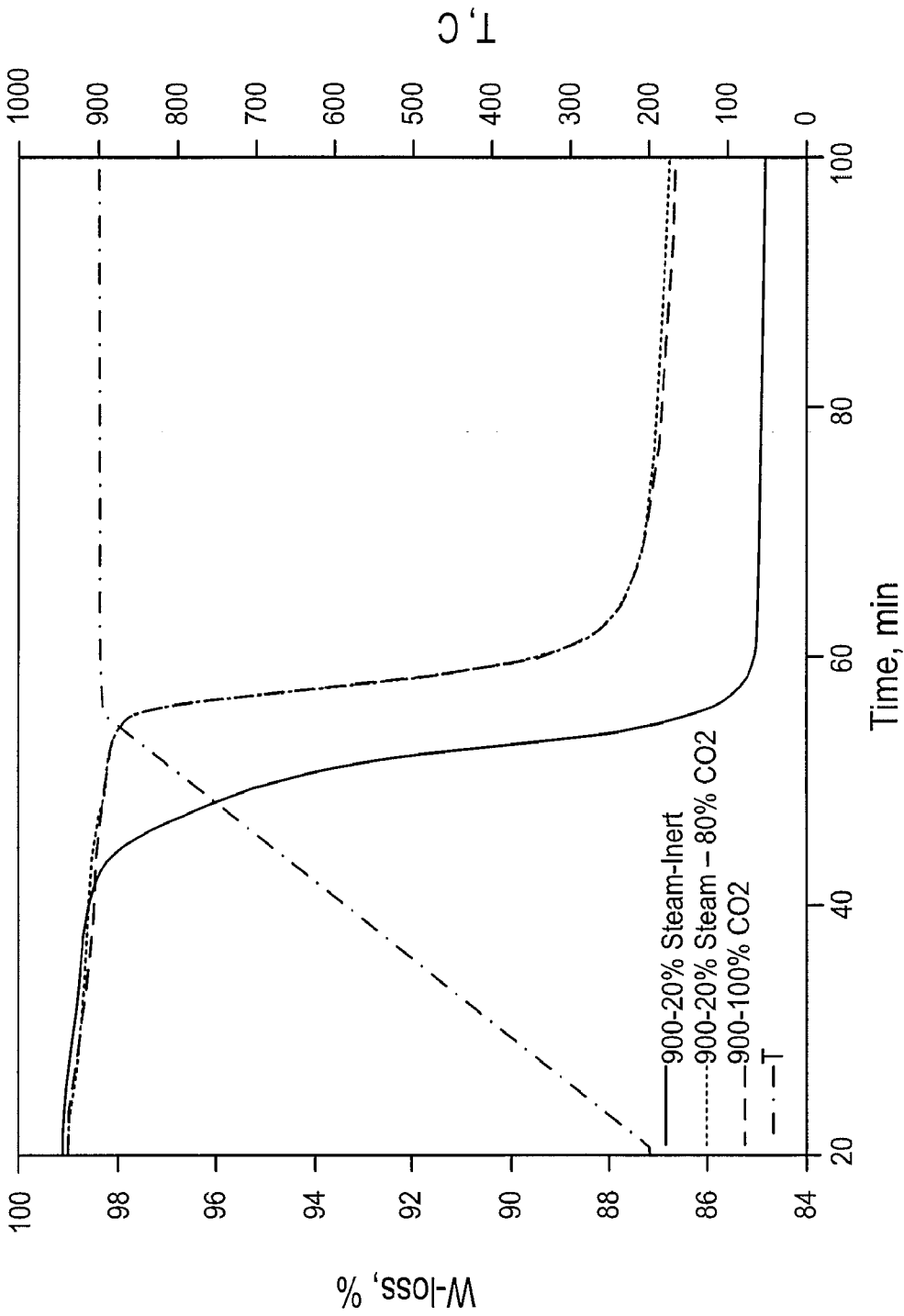

FIG. 20