



US00D910459S

(12) **United States Design Patent** (10) **Patent No.:** **US D910,459 S**
Dietvorst (45) **Date of Patent:** **** *Feb. 16, 2021**

(54) **CAPSULE CONTAINING WASHING PRODUCT**

(71) Applicant: **Reckitt Benckiser Finish B.V.**,
Hoofddorp (NL)

(72) Inventor: **Taco Dietvorst**, Eindhoven (NL)

(73) Assignee: **RECKITT BENCKISER FINISH B.V.**,
Hoofddorp (NL)

(*) Notice: This patent is subject to a terminal disclaimer.

(**) Term: **15 Years**

(21) Appl. No.: **29/689,259**

(22) Filed: **Apr. 29, 2019**

(30) **Foreign Application Priority Data**

Nov. 2, 2018 (EP) 005815495-0003

(51) **LOC (13) Cl.** **09-05**

(52) **U.S. Cl.** **D9/707**

USPC **D9/707**

(58) **Field of Classification Search**

USPC D9/702-714, 414-416, 428, 421,
D9/424-426, 430-432, 759; D28/4-8,
D28/8.1-8.2

CPC C11D 17/0065-17/0091; C11D
17/00-17/0039; C11D 17/04-17/047

See application file for complete search history.

(56) **References Cited**

U.S. PATENT DOCUMENTS

D806,948 S *	1/2018	Dietvorst	D28/8.1
D808,584 S *	1/2018	Dietvorst	D28/8.1
D809,203 S *	1/2018	Dietvorst	D28/8.1
D825,847 S *	8/2018	Wissmann	D28/8.1
D838,038 S *	1/2019	Tarnowsky	D28/8.1

* cited by examiner

Primary Examiner — Abraham Bahta

(74) *Attorney, Agent, or Firm* — Troutman Pepper
Hamilton Sanders LLP; Ryan Schneider; Chris N. Davis

(57) **CLAIM**

The ornamental design for a capsule containing washing product, as shown and described.

DESCRIPTION

FIG. 1 is a perspective view of my new design for a capsule containing washing product;
FIG. 2 is a front view thereof;
FIG. 3 is a rear view thereof;
FIG. 4 is a left view thereof;
FIG. 5 is a right view thereof;
FIG. 6 is a top view thereof; and,
FIG. 7 is a bottom view thereof.

1 Claim, 3 Drawing Sheets

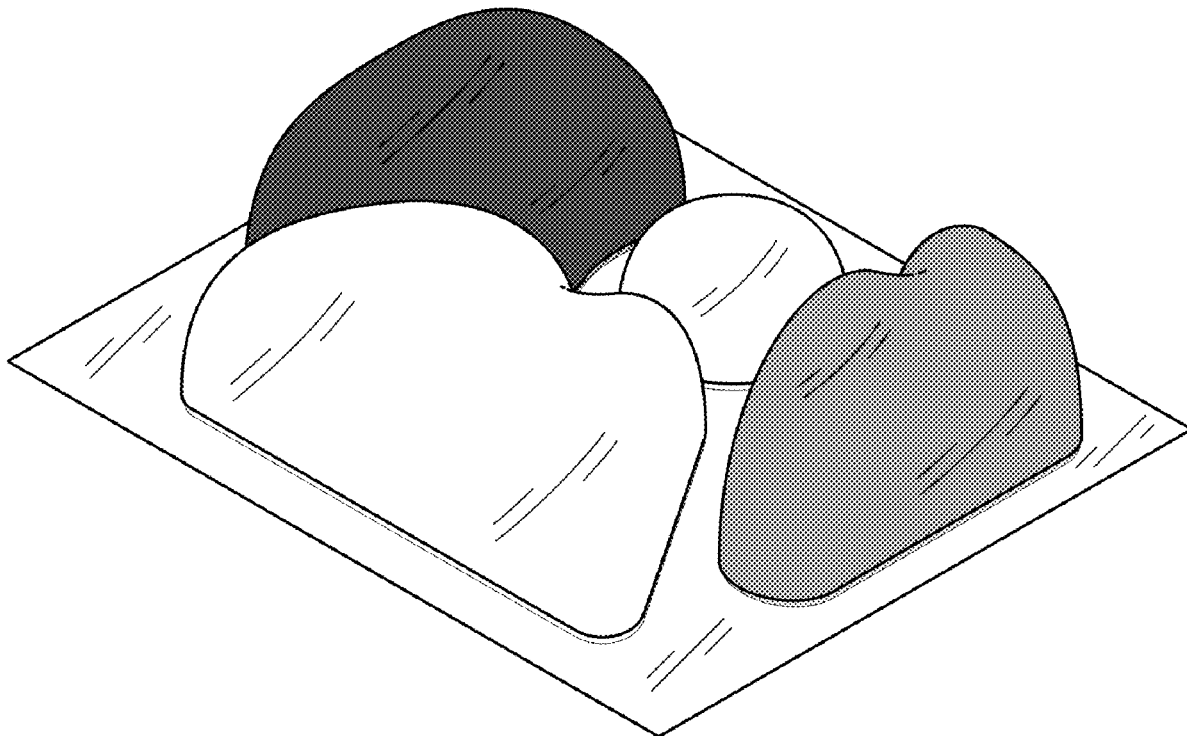

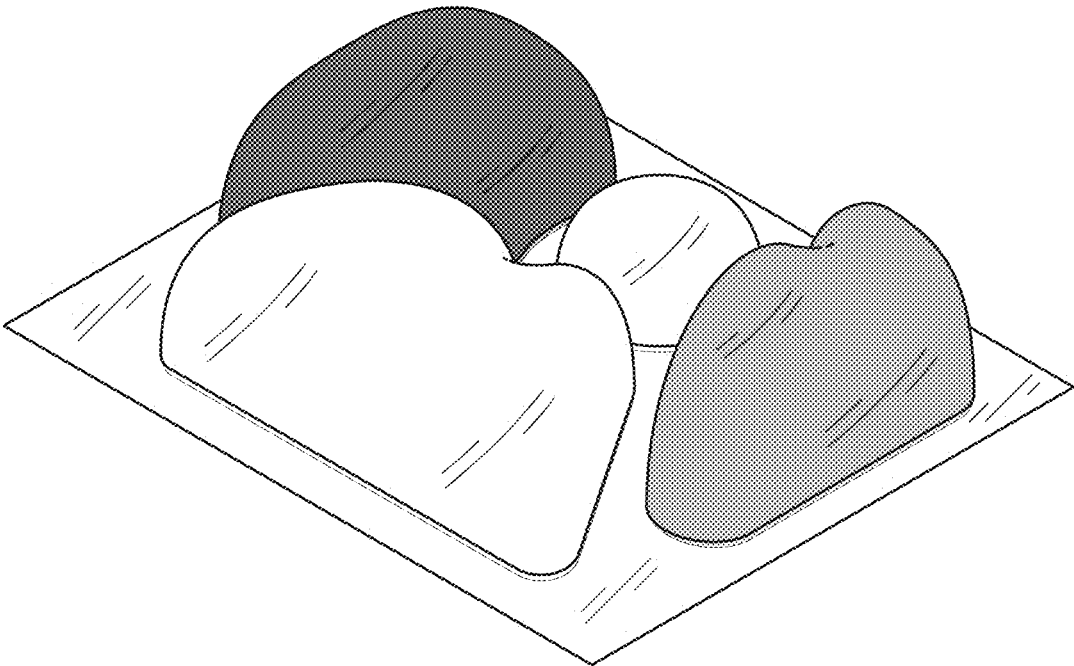

Fig. 1

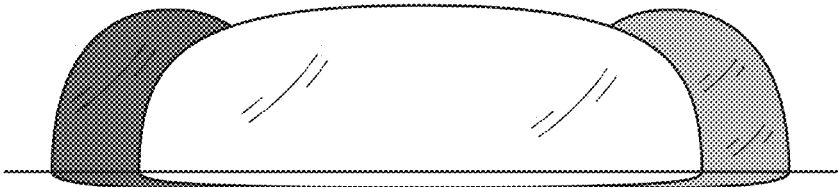

Fig. 2

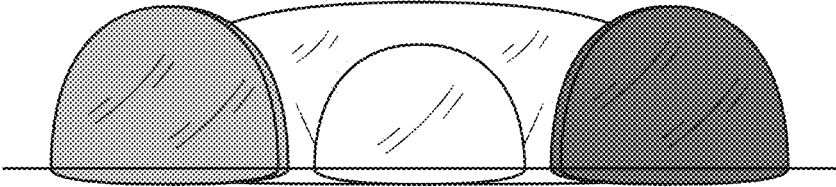

Fig. 3

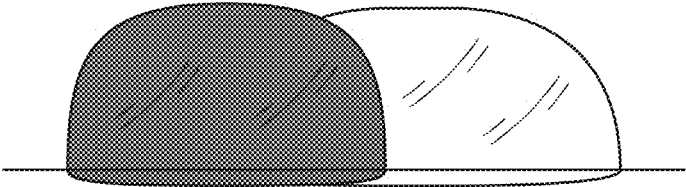

Fig. 4

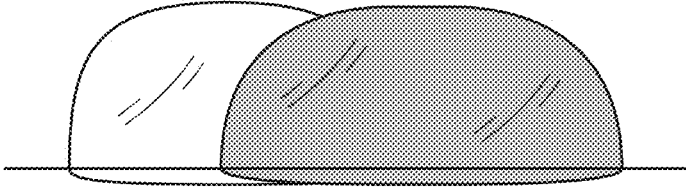

Fig. 5

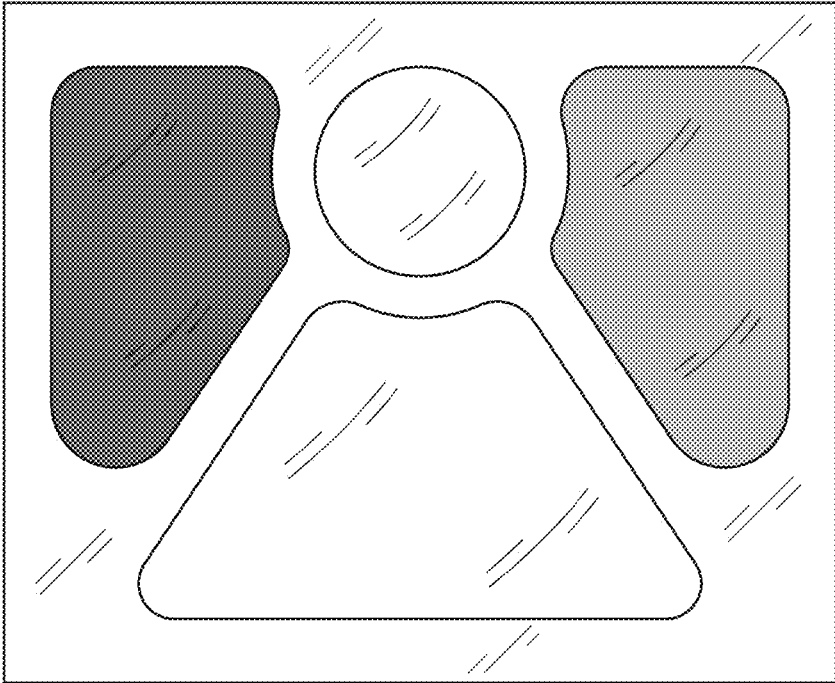

Fig. 6

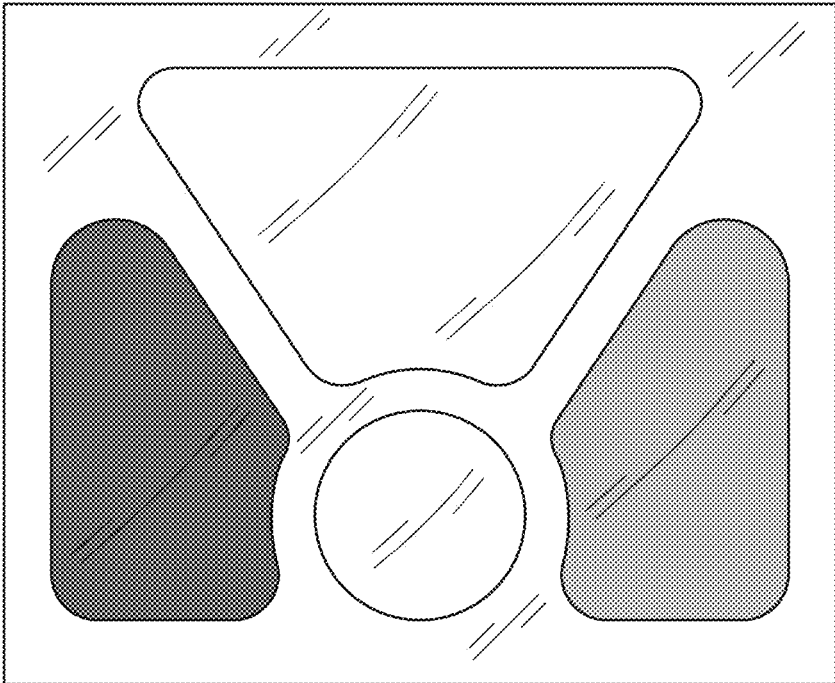

Fig. 7