



US 20020198041A1

(19) **United States**

(12) **Patent Application Publication**  
**Suganuma**

(10) **Pub. No.: US 2002/0198041 A1**

(43) **Pub. Date: Dec. 26, 2002**

(54) **DEVICE FOR SETTING NUMBER OF WINNING LINES AND NUMBER OF TOKEN BET IN SLOT MACHINE**

**Publication Classification**

(51) **Int. Cl.<sup>7</sup> ..... A63F 9/24**  
(52) **U.S. Cl. .... 463/20**

(75) **Inventor: Masanori Suganuma, Tokyo (JP)**

Correspondence Address:  
**SUGHRUE MION, PLLC**  
**2100 PENNSYLVANIA AVENUE, N.W.**  
**WASHINGTON, DC 20037 (US)**

(57) **ABSTRACT**

In a slot machine in which each of a plurality of reel sections are cyclically moved in a predetermined direction, and a reward corresponding to a number of bet token per a selected pay line is paid out when a predetermined symbol combination is arranged on at least one selected pay line, a selector selects either a number of selected pay line or a number of bet token per a selected pay line as a setting object. A display device displays the number of selected pay line and the number of bet token. A setting provider updates a number of the setting object by incrementing or decrementing manner.

(73) **Assignee: KONAMI CORPORATION**

(21) **Appl. No.: 10/175,880**

(22) **Filed: Jun. 21, 2002**

(30) **Foreign Application Priority Data**

Jun. 22, 2001 (JP) ..... P2001-189897

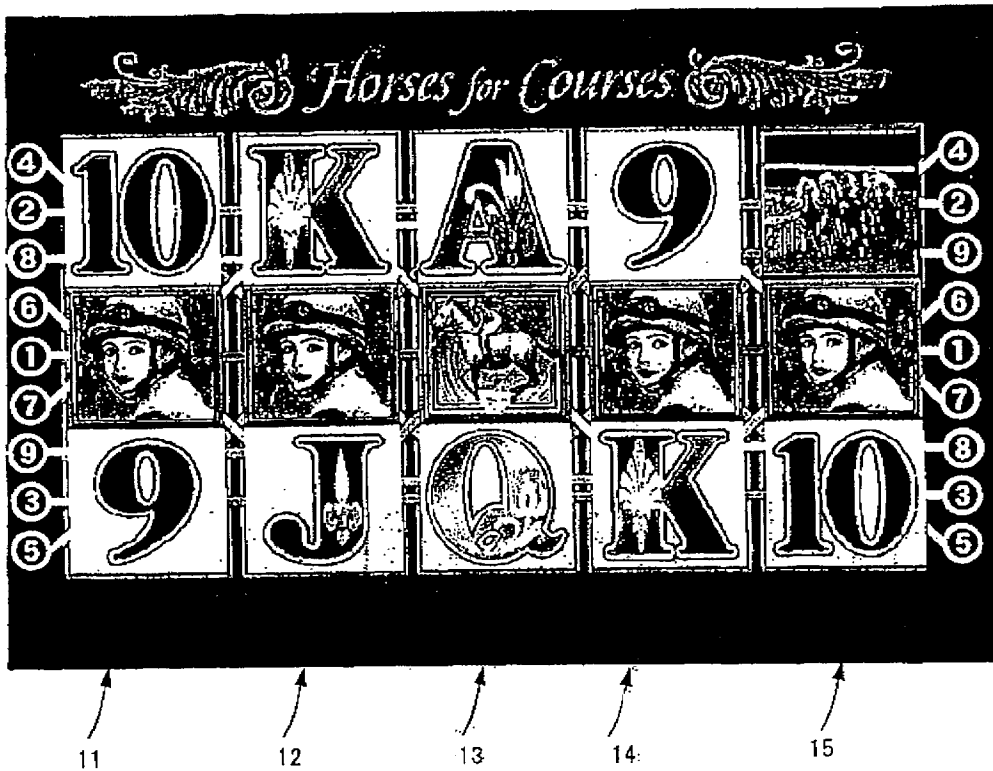

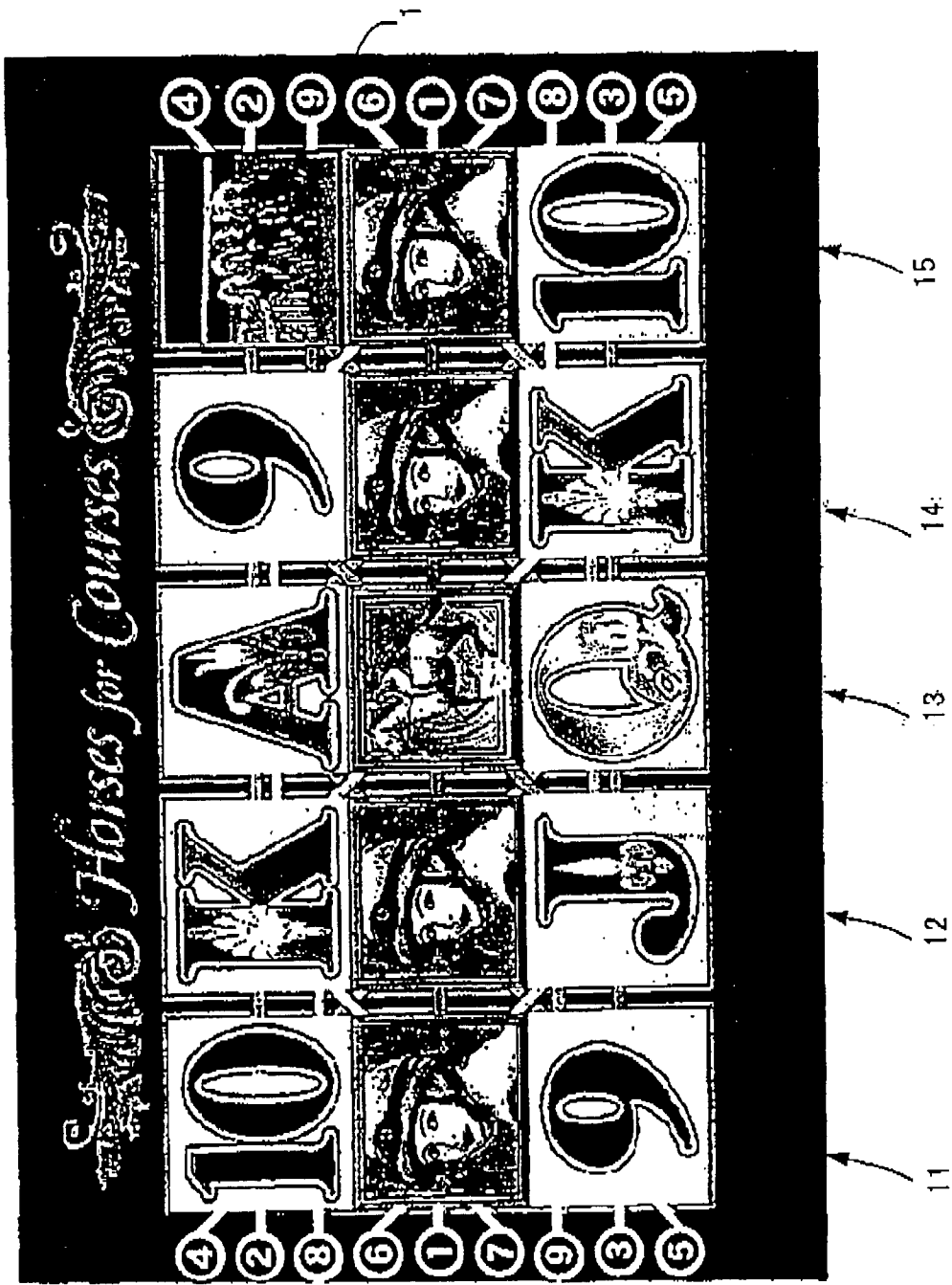

*Fig. 1*

*Fig. 2*

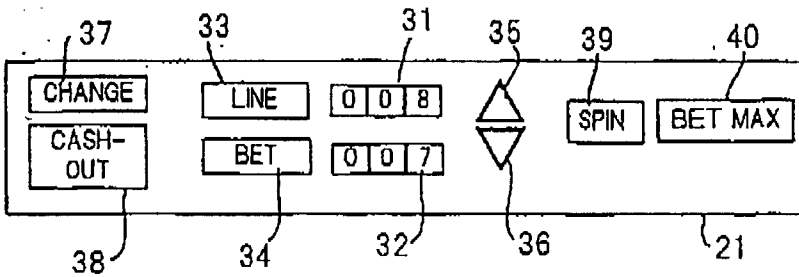
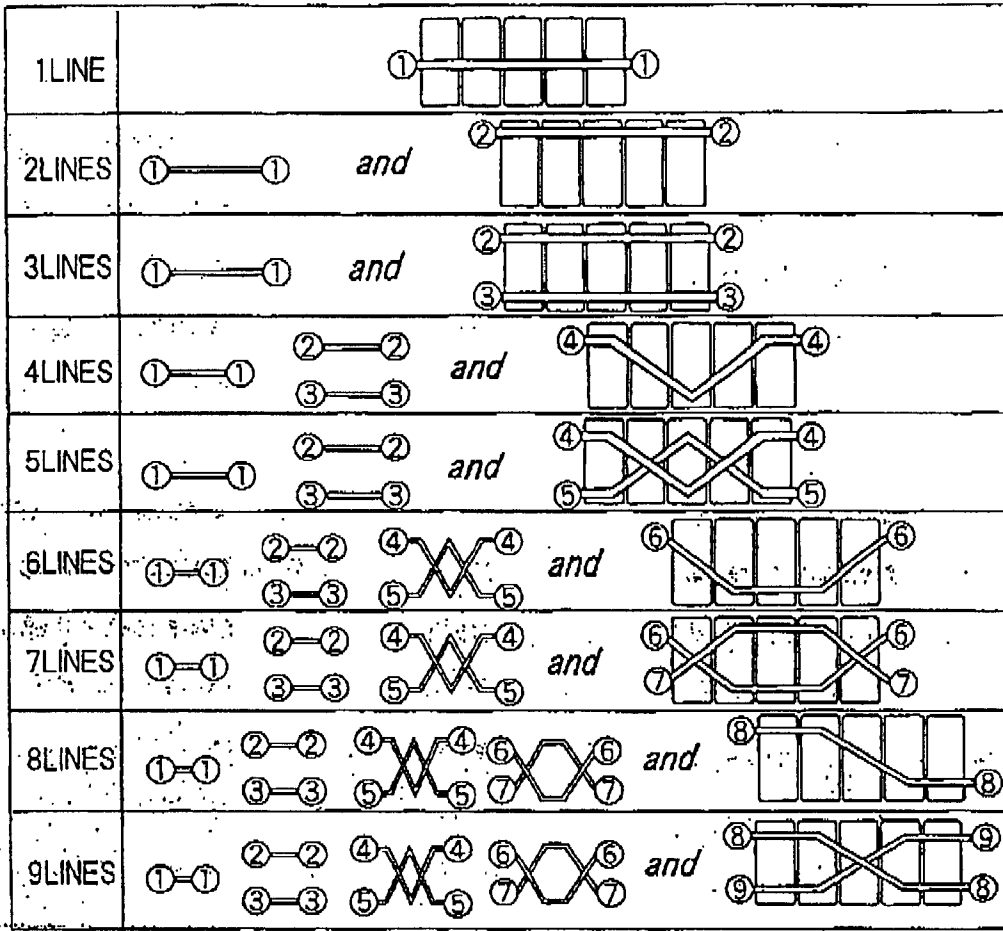

*Fig. 3*

*Fig. 4.*

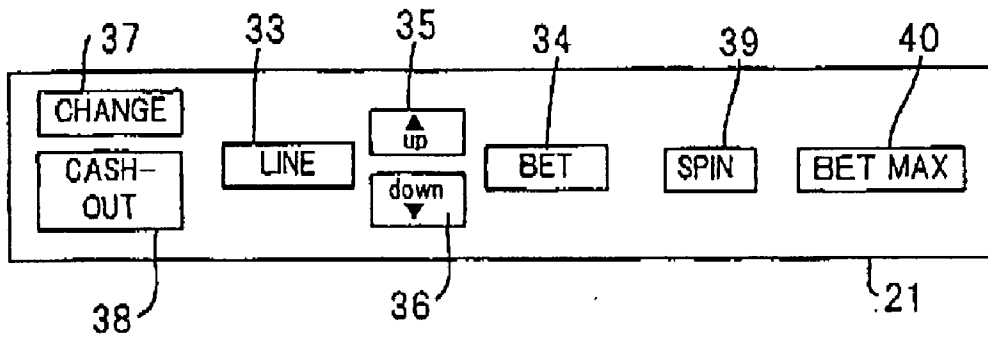

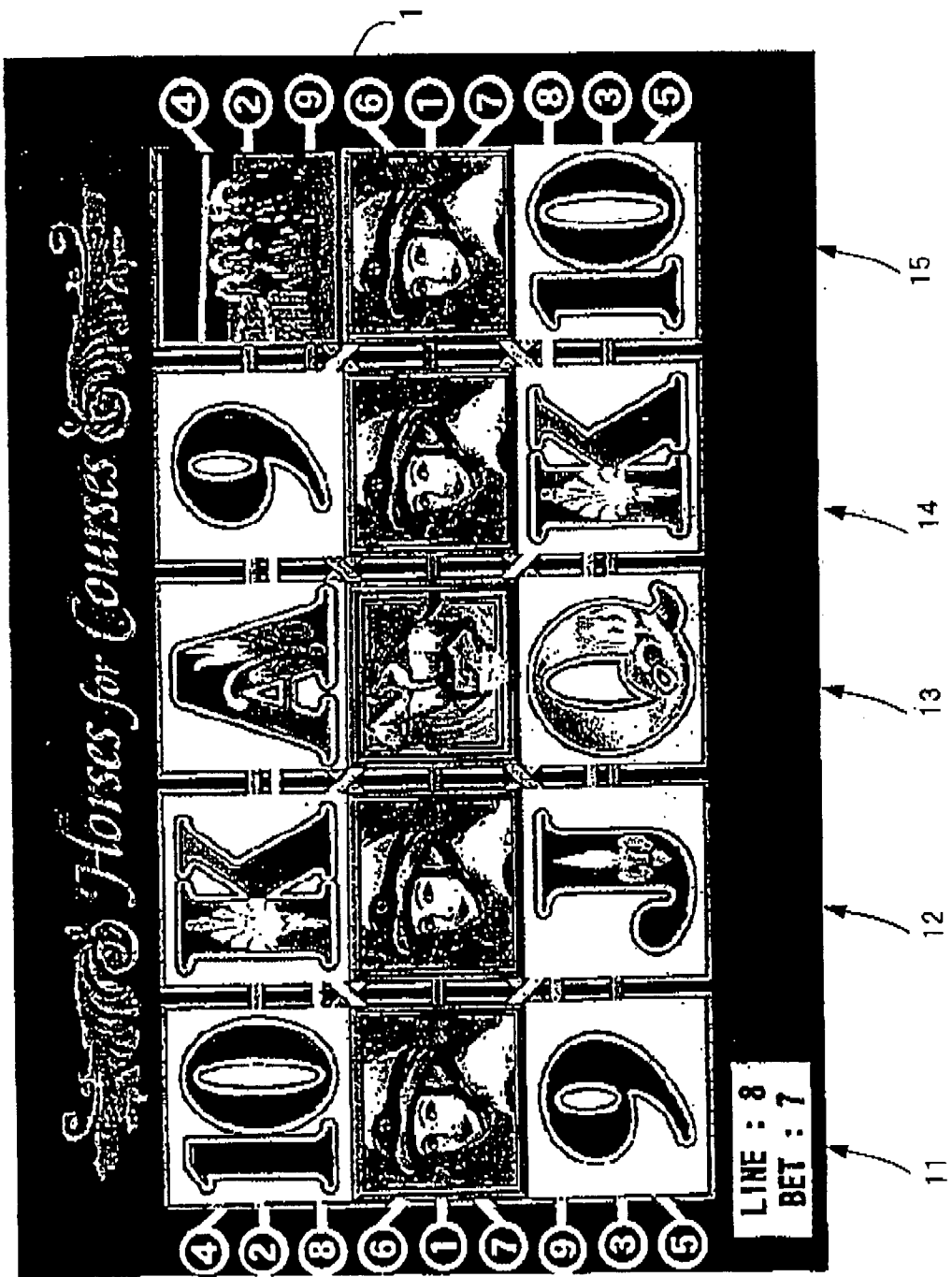
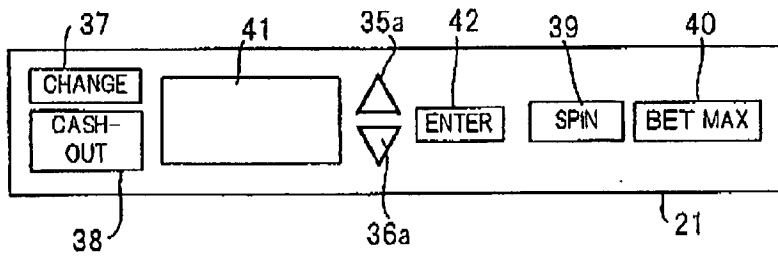

Fig. 5

**Fig. 6**



**Fig. 7A**

**Fig. 7B**

**Fig. 7C**

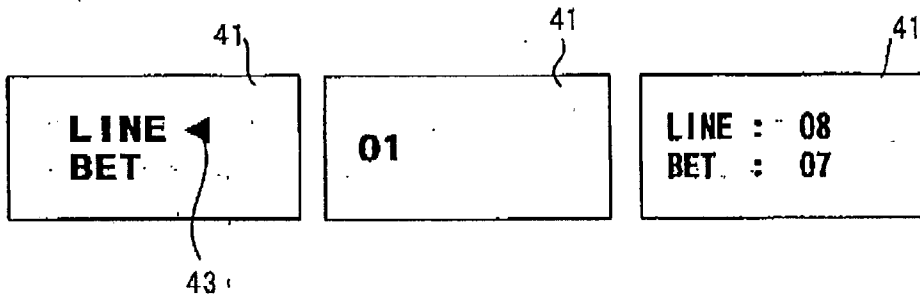

**Fig. 8A**

**Fig. 8B**

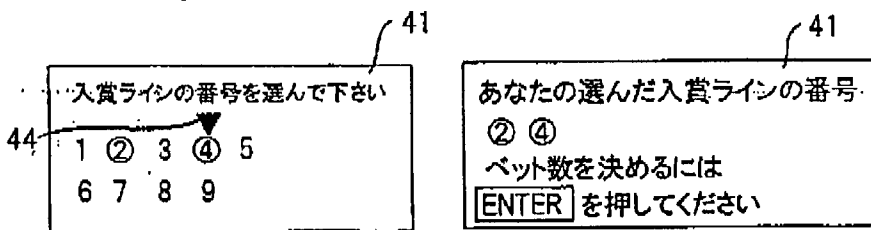

**Fig. 9**

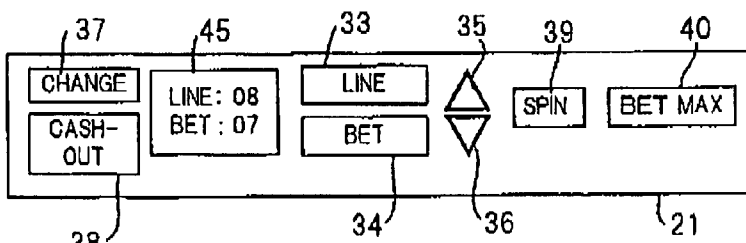
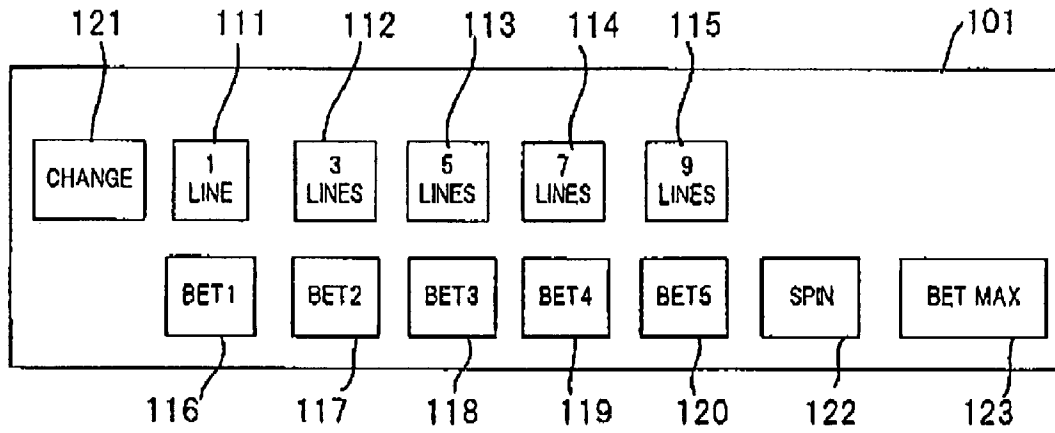

Fig. 8A: Mark the number of pay line you want to select.

Fig. 8B: Selected pay line:

Press ENTER key to determine the number of bet token.

*Fig. 10*



## DEVICE FOR SETTING NUMBER OF WINNING LINES AND NUMBER OF TOKEN BET IN SLOT MACHINE

### BACKGROUND OF THE INVENTION

[0001] The invention relates to a device for setting the number of pay lines and the number of bet tokens in a slot machine.

[0002] A slot machine of reel type or video type has hitherto been known as an amusement machine to be installed in a casino or a like place. A video-type slot machine (hereinafter called simply a "video slot") is equipped with, e.g., a monitor display device consisting of a CRT (cathode ray tube). Displayed on the monitor display device are a plurality of reel sections for cyclically actuating a plurality of types of symbols vertically. When a predetermined symbol is constituted along a valid pay line as a result of the plurality of reel sections having come to a standstill, a payout corresponding to the number of bet tokens per pay line is paid out.

[0003] In relation to such a slot machine, the number of valid pay lines and the number of bet tokens per pay line are set, by a device for setting the number of pay lines and the number of bet tokens, such as that shown in, e.g., FIG. 10. More specifically, a panel 101 has a number-of-lines setting button 111 to be used for setting the number of valid lines to "one"; a number-of-lines setting button 112 to be used for setting the number of valid lines to "three"; a number-of-lines setting button 113 to be used for setting the number of valid lines to "five"; a number-of-lines setting button 114 to be used for setting the number of valid lines to "seven"; and a number-of-lines setting button 115 to be used for setting the number of valid lines to "nine." Further, the panel 101 has a bet setting button 116 to be used for setting the number of bet tokens per pay line to "one"; a bet setting button 117 to be used for setting the number of bet tokens per pay line to "two"; a bet setting button 118 to be used for setting the number of bet tokens per pay line to "three"; a bet setting button 119 to be used for setting the number of bet tokens per pay line to "four"; and a bet setting button 120 to be used for setting the number of bet tokens per pay line to "five." The player selectively presses any one of the bet setting buttons 116 through 120, and selectively presses any one of the number-of-lines setting buttons 111 through 115, thereby enabling setting of the number of valid pay lines and the number of bet tokens per pay line. The panel 101 has a change button 121 for calling a clerk in charge; a spin button 122 for vertically moving a symbol by spinning a plurality of displayed reel sections; and a max bet button 123 for maximizing the number of bet tokens (i.e., setting the number of bet tokens per pay line to five by setting the number of valid pay lines to nine).

[0004] However, in relation to the related-art number-of-lines and bet setting device, the number of valid pay lines is limited to "1," "3," "5," "7," and "9," and the number of bet tokens per pay line is limited to "1," "2," "3," "4," and "5." Even when the player desires to set the number of valid pay lines to another value (e.g., 8), such setting has hitherto been impossible. Moreover, even when the player desires to set the number of bet tokens per pay line to another value (e.g., 7), such setting has hitherto been impossible. In this case, an increase in the number of the setting buttons is also con-

ceivable. However, a limitation is imposed on the space for setting buttons, thereby posing difficulty in increasing the number of setting buttons. An increase in the number of setting buttons also results in complication of wiring.

### SUMMARY OF THE INVENTION

[0005] It is therefore an object of the present invention to provide a device for setting the number of pay lines and the number of bet tokens in a slot machine, which enables the player to set the number of valid pay lines and the number of bet tokens per pay line to respective desired values without increasing the number of buttons.

[0006] In order to achieve the above object, according to the present invention, there is provided a device incorporated in a slot machine in which each of a plurality of reel sections are cyclically moved in a predetermined direction, and a reward corresponding to a number of bet token per a selected pay line is paid out when a predetermined symbol combination is arranged on at least one selected pay line, for setting a number of selected pay line and a number of bet token per a selected pay line, comprising:

[0007] a selector, which selects either the number of selected pay line or the number of bet token as a setting object;

[0008] a display device, which displays the number of selected pay line and the number of bet token; and

[0009] a setting provider, which updates a number of the setting object by incrementing or decrementing manner.

[0010] Preferably, the display device is a light-emitting diode device.

[0011] Preferably, the display device is a monitor device which displays the reel sections.

[0012] Preferably, the display device is a liquid crystal display device.

[0013] Preferably, the display device displays numbers associated with each pay line when the number of selected pay line is selected as the setting object. Here, the setting provider specifies at least one number of the pay line to determine the number of selected pay line.

[0014] Preferably, the setting provider increments or decrements either the number of selected pay line or the number of bet token one by one.

[0015] According to the present invention, there is also provided a method used in a slot machine in which each of a plurality of reel sections are cyclically moved in a predetermined direction, and a reward corresponding to a number of bet token per a selected pay line is paid out when a predetermined symbol combination is arranged on at least one selected pay line, for setting a number of selected pay line and a number of bet token per a selected pay line, comprising the steps of:

[0016] selecting either the number of selected pay line or the number of bet token as a setting object; and

[0017] updating a number of the setting object by incrementing or decrementing manner, while displaying an updated number of the setting object.



[0018] According to the above configurations, a player can set the number of valid pay lines and the number of bet tokens to respective desired values without involvement of an increase in the number of buttons.

#### BRIEF DESCRIPTION OF THE DRAWINGS

[0019] The above objects and advantages of the present invention will become more apparent by describing in detail preferred exemplary embodiments thereof with reference to the accompanying drawings, wherein:

[0020] **FIG. 1** is a view showing a monitor display device provided in a video-type slot machine according to a first embodiment of the invention;

[0021] **FIG. 2** is a view showing a relationship between the number of valid pay lines and the lines that are made valid according to the first embodiment;

[0022] **FIG. 3** is a plan view showing a device for setting the number of pay lines and the number of bet tokens according to the first embodiment;

[0023] **FIG. 4** is a plan view showing a device for setting the number of pay lines and the number of bet tokens according to a second embodiment of the invention;

[0024] **FIG. 5** is a view showing a monitor display device provided in a video-type slot machine according to the second embodiment;

[0025] **FIG. 6** is a plan view showing a device for setting the number of pay lines and the number of bet tokens according to a third embodiment of the invention;

[0026] **FIGS. 7A to 7C** are views showing display examples of a liquid-crystal display device provided in the device for setting the number of pay lines and the number of bet tokens according to the third embodiment;

[0027] **FIGS. 8A and 8B** are views showing display examples of a liquid-crystal display device relating to a modification of the device for setting the number of pay lines and the number of bet tokens according to the third embodiment;

[0028] **FIG. 9** is a plan view showing a device for setting the number of pay lines and the number of bet tokens according to a fourth embodiment of the invention; and

[0029] **FIG. 10** is a plan view showing an example of a related-art device for setting the number of pay lines and the number of bet tokens.

#### DETAILED DESCRIPTION OF THE PREFERRED EMBODIMENTS

[0030] With reference to the accompanying drawings, there will be provided detailed description of preferred embodiments of the invention.

[0031] As shown in **FIG. 1**, a video-type slot machine according to a first embodiment is equipped with a monitor display device **1** consisting of, e.g., a CRT. Displayed on such a monitor display device **1** are a plurality of reel sections **11** through **15** (five reel sections in the embodiment) for cyclically moving a plurality of types of symbols in a predetermined direction (a vertical direction in the embodiment). When the reel sections **11** through **15** come to a standstill, three symbols are simultaneously displayed for

each reel section; namely, a total of 15 symbols are displayed. As shown in **FIG. 2**, nine pay lines (**1**) through (**9**) are provided across the reel sections **11** through **15**. When the number of valid pay lines is set to "one" (ONE LINE), only the pay line (**1**) is made valid. When the number of valid pay lines is set to "two" (TWO LINES), the pay lines (**1**) and (**2**) are made valid. When the number of valid pay lines is set to "three" (THREE LINES), the pay lines (**1**) through (**3**) are made valid. A similar arrangement applies to a case where the number of valid pay lines is set to any of "four" to "nine" (FOUR LINES to NINE LINES). When a predetermined combination of symbols is constituted along a valid pay line when the reel sections **11** through **15** have come to a standstill, the player is provided a payout corresponding to the number of bet tokens on the pay line. In the embodiment, the number of valid pay lines can be set to a maximum of "nine," and the number of bet tokens per pay line can be set to a maximum of **FIG. 3** is a plan view showing a device which sets the number of pay lines and the number of bet tokens according to the first embodiment, for the purpose of setting the number of valid pay lines and bet tokens per pay line. As shown in **FIG. 3**, the panel **21** is provided with a light-emitting diode display device **31** for displaying the number of valid pay lines, and a light-emitting diode display device **32** for displaying the number of bet tokens per pay line. The light-emitting diode devices **31, 32** constitute a display device. Here, a seven-segment or 16-segment display device is used for the light-emitting diode devices **31, 32**. The panel **21** is further equipped with a number-of-lines selection button **33** to be used for selecting the number of valid pay lines as an object of setting, and a bet selection button **34** to be used for selecting the number of bet tokens per pay line as an object of setting. The number-of-lines selection button **33** and the bet selection button **34** constitute a selector.

[0032] The panel **21** is further equipped with an UP button **35** and a DOWN button **36**. The UP button **35** is for setting in an incrementing manner the number of valid pay lines selected by the number-of-lines selection button **33** or the number of bet tokens per pay line selected by the bet selection button **34**. The DOWN button **36** is for setting in a decrementing manner the number of valid pay lines selected by the number-of-lines selection button **33** or the number of bet tokens per pay line selected by the bet selection button **34**. Here, the UP button **35** and the DOWN button **36** constitute a setting provider.

[0033] The panel **21** is equipped with a CHANGE button **37** for calling a clerk in charge; a CASH-OUT button **38** for effecting a payout of credited gaming tokens; a SPIN button **39** for moving a symbol vertically by spinning the displayed reel sections **11** through **15**; and a MAX BET button **40** for maximizing the number of bet tokens (i.e., the number of bet tokens per pay line to "10" by setting the number of valid pay lines to "9").

[0034] In relation to the device of the embodiment having such a configuration for setting the number of pay lines and the number of bet tokens, the player selects the number of valid pay lines as an object of setting, by pressing the number-of-lines selection button **33**. The player can set the number of valid pay lines to a desired value in an incrementing or decrementing manner, by pressing the UP or DOWN button **35** or **36** while viewing a display on the light-emitting diode display device **31**. Further, the player

can set the number of bet tokens per pay line to a desired value in an incrementing or decrementing manner, by selecting the number of bet tokens per pay line as an object of setting through pressing of the bet selection button **34** and pressing the UP or DOWN button **35** or **36** while viewing a display on the light-emitting diode display device **32**. The related-art device (see **FIG. 10**) cannot set the number of valid pay lines to, e.g., "eight" or set the number of bet tokens per pay line to, e.g., "seven." However, the device of the embodiment which sets the number of pay lines and the number of bet tokens enables these settings.

[0035] **FIG. 4** is a plan view showing a device which sets the number of pay lines and the number of bet tokens according to a second embodiment, for the purpose of setting the number of valid pay lines and the number of bet tokens per pay line. As shown in **FIG. 4**, the panel **21** has the number-of-lines selection button **33** to be used for selecting the number of valid pay lines as an object of setting, and the bet selection button **34** to be used for selecting the number of bet tokens per pay line as an object of setting. The number-of-lines selection button **33** and the bet selection button **34** are constituted so as to be illuminated through use of, e.g., miniature light bulbs, when pressed. The number-of-lines selection button **33** and the bet selection button **34** constitute a selector.

[0036] The panel **21** is further equipped with the UP button **35** and the DOWN button **36**. The UP button **35** is for setting in an incrementing manner the number of valid pay lines selected by the number-of-lines selection button **33** or the number of bet tokens per pay line selected by the bet selection button **34**. The DOWN button **36** is for setting in a decrementing manner the number of valid pay lines selected by the number-of-lines selection button **33** or the number of bet tokens per pay line selected by the bet selection button **34**. Here, the UP button **35** and the DOWN button **36** constitute a setting provider.

[0037] The panel **21** is equipped with the CHANGE button **37**, the CASH-OUT button **38**, the SPIN button **39**, and the MAX BET button **40**. These buttons are identical with those described in connection with the first embodiment, and their repeated explanations are omitted.

[0038] The video-type slot machine provided with the device for setting the number of valid pay lines and the number of bet tokens according to the embodiment also has the monitor display device **1** constituted of, e.g., a CRT, as in the case of the first embodiment (see **FIG. 1**). As shown in **FIG. 5**, the monitor display device **1** indicates the five reel sections **11** through **15**. Further, the number of valid pay lines (LINE) and the number of bet tokens per pay line (BET) are also displayed in a lower left end on the screen of the monitor display device **1**. More specifically, in the embodiment, the monitor display device **1** has the function of serving as a display device. In other respects, the video-type slot machine is identical with that described in connection with the first embodiment, and hence its repeated explanation is omitted.

[0039] In relation to the device of the embodiment having such a configuration for setting the number of pay lines and the number of bet tokens, the player selects the number of valid pay lines as an object of setting, by pressing the number-of-lines selection button **33**. The player can set the number of valid pay lines to a desired value in an incre-

menting or decrementing manner, by pressing the UP or DOWN button **35** or **36** while viewing a display pertaining to the number of valid lines (LINE) on the monitor display device **1**. Further, the player can set the number of bet tokens per pay line to a desired value in an incrementing or decrementing manner, by selecting the number of bet tokens per pay line as an object of setting through pressing of the bet selection button **34** and pressing the UP or DOWN button **35** or **36** while viewing a display pertaining to the number of bet tokens per pay line (BET) on the monitor display device **1**. The related-art device (see **FIG. 10**) cannot set the number of valid pay lines to, e.g., "eight" or set the number of bet tokens per pay line to, e.g., "seven." However, the device of the embodiment, which sets the number of pay lines and the number of bet tokens, enables these settings.

[0040] **FIG. 6** is a plan view showing a device which sets the number of pay lines and the number of bet tokens according to a third embodiment, for the purpose of setting the number of valid pay lines and bet tokens per pay line. As shown in **FIG. 6**, the panel **21** has a liquid-crystal display device **41** for displaying values, such as the number of valid pay lines and the number of bet tokens per pay line. Here, the liquid-crystal display device **41** constitutes a display device. A device capable of displaying all kinds of image information is used as the liquid-crystal display device **41**. The panel **21** is also equipped with an UP button **35a** and a DOWN button **36a**. The UP button **35a** is for moving a cursor **43** (see **FIG. 7A**), which will be described later, upward for selecting the number of valid pay lines as an object of setting and setting in an incrementing manner the number of valid pay lines or the number of bet tokens per pay line selected. The DOWN button **36a** is for moving the cursor **43**, which will be described later, downward for selecting the number of valid pay lines as an object of setting and setting in a decrementing manner the number of valid pay lines or the number of bet tokens selected. Here, the UP button **35a** and the DOWN button **36a** constitute a selector and a setting provider.

[0041] The panel **21** is further equipped with an ENTER button **42** for rendering permanent a selection or setting effected by the UP or DOWN button **35a** or **36a**. Here, the panel **21** has the CHANGE button **37**, the CASH-OUT button **38**, the SPIN button **39**, and the MAX BET button **40**. Those buttons are identical with those described in connection with the first embodiment, and their repeated explanations are omitted. Moreover, the video-type slot machine having the device of the embodiment for setting the number of pay lines and the number of bet tokens is identical with that described in connection with the first embodiment, and hence its repeated explanation is omitted.

[0042] In relation to the device of the embodiment having such a configuration for setting the number of pay lines and the number of bet tokens, the player selects the number of valid pay lines (LINE) as an object of setting, by pressing the UP button **35a** while viewing a display on the liquid-crystal display device **41** such as that shown in **FIG. 7A**, to thereby move the cursor **43** upward. Subsequently, the player presses the ENTER button **42**, thereby rendering the selection valid. Next, the player presses the UP or DOWN button **35a** or **36a** while viewing a display pertaining to the number of valid pay lines on the liquid-crystal display device **41** (a number-of-winning-lines setting screen), such as that shown in **FIG. 7B**, thereby setting the number of valid pay lines to a desired

value in an incrementing or decrementing manner. Subsequently, the player presses the ENTER button 42, thereby rendering the selection valid. The player presses the DOWN button 36a while viewing a display on the liquid-crystal display device 41 (a number-of-winning-lines/number-of-tokens-bet selection screen), such as that shown in FIG. 7A, thereby moving the cursor 43 downward and selecting the number of bet tokens per pay line (BET) as an object of setting. Subsequently, the player presses the ENTER button 42, thereby rendering the selection valid. Next, the player presses the UP or DOWN button 35a or 36a while viewing a display pertaining to the number of bet tokens per pay line on the liquid-crystal display device 41 (a bet setting screen), such as that shown in FIG. 7B, thereby setting the number of bet tokens per pay line to a desired value in an incrementing or decrementing manner. Subsequently, the user presses the ENTER button 42, thereby rendering the setting valid.

[0043] At this time, the liquid-crystal display device 41 displays the thus-confirmed number of valid pay lines and the thus-confirmed number of bet tokens per pay line, such as those shown in FIG. 7C. The related-art device (see FIG. 10) cannot set the number of valid pay lines to, e.g., “eight” or set the number of bet tokens per pay line to, e.g., “seven.” However, the device of the embodiment, which sets the number of pay lines and the number of bet tokens, enables these settings.

[0044] The device of the embodiment for setting the number of pay lines and the number of bet tokens can be constructed so as to enable setting of a valid pay line number. In this case, the player presses the UP button 35a while viewing a display on the liquid-crystal display device 41 (a number-of-winning-lines/number-of-tokens-bet selection screen), such as that shown in FIG. 7A, to thereby move the cursor 43 upward and set a valid pay line number (LINE) as an object of setting. The player presses the ENTER button 42, thereby rendering the selection valid. Next, the player presses the UP or DOWN button 35a or 36a while viewing a display pertaining to pay line numbers “1” through “9” which are provided on the liquid-crystal display device 41 for selection (i.e., a pay line number selection screen), such as that shown in FIG. 8A. The player presses the UP button 35a or the DOWN button 36a each time he wishes a cursor 44 to move to a desired number, thereby selecting valid pay line numbers. Subsequently, the player presses the ENTER button 42 twice, thereby rendering the selections (i.e., settings) valid. Next, the player can ascertain the selected valid pay line numbers while viewing a display on the liquid-crystal display device 41 (a selected pay line number confirmation screen), such as that shown in FIG. 8B. FIGS. 8A and 8B show an example in which “2” and “4” have been selected as valid pay line numbers. In this example, the pay lines “2” and “4” (see FIG. 2) are rendered valid. Here, the number of valid pay lines is “two.”

[0045] When the monitor display device 1 (see FIG. 1) has broken, the monitor display device 1 may fail to display an error code reporting that failure. In preparation for such a case, the liquid-crystal display device 41 may be configured so as to display an error code.

[0046] FIG. 9 is a plan view showing a device which sets the number of pay lines and the number of bet tokens according to a fourth embodiment, for the purpose of setting

the number of valid pay lines and bet tokens per pay line. As shown in FIG. 9, the panel 21 has a liquid-crystal display device 45 for displaying values, such as the number of valid pay lines and the number of bet tokens per pay line. Here, the liquid-crystal display device 45 constitutes a display device. A device capable of displaying only predetermined characters or numerals (e.g., a device cheaper than the liquid-crystal display device 41 described in connection with the third embodiment) is used as the liquid-crystal display device 41. The panel 21 is further equipped with the number-of-lines selection button 33 to be used for selecting the number of valid pay lines as an object of setting, and the bet selection button 34 to be used for selecting the number of bet tokens per pay line as an object of setting. The number-of-lines selection button 33 and the bet selection button 34 constitute a selector.

[0047] The panel 21 is further equipped with the UP button 35 and the DOWN button 36. The UP button 35 is for setting in an incrementing manner the number of valid pay lines selected by the number-of-lines selection button 33 or the number of bet tokens per pay line selected by the bet selection button 34. The DOWN button 36 is for setting in a decrementing manner the number of valid pay lines selected by the number-of-lines selection button 33 or the number of bet tokens per pay line selected by the bet selection button 34. Here, the UP button 35 and the DOWN button 36 constitute a setting provider. The panel 21 has the CHANGE button 37, the CASH-OUT button 38, the SPIN button 39, and the MAX BET button 40. Those buttons are identical with those described in connection with the first embodiment, and their repeated explanations are omitted. Moreover, the video-type slot machine having the device of the embodiment for setting the number of pay lines and the number of bet tokens is identical with that described in connection with the first embodiment, and hence its repeated explanation is omitted.

[0048] In relation to the device of the embodiment having such a configuration for setting the number of pay lines and the number of bet tokens, the player selects the number of valid pay lines as an object of setting, by pressing the number-of-lines selection button 33. The player can set the number of valid pay lines to a desired value in an incrementing or decrementing manner, by pressing the UP or DOWN button 35 or 36 while viewing a display pertaining to the number of valid lines on the liquid-crystal display device 45. Further, the player can set the number of bet tokens per pay line to a desired value in an incrementing or decrementing manner, by selecting the number of bet tokens per pay line as an object of setting through pressing of the bet selection button 34 and pressing the UP or DOWN button 35 or 36 while viewing a display pertaining to the number of bet tokens per pay line on the liquid-crystal display device 45. The related-art device (see FIG. 10) cannot set the number of valid pay lines to, e.g., “eight” or set the number of bet tokens per pay line to, e.g., “seven.” However, the device of the embodiment, which sets the number of pay lines and the number of bet tokens, enables these settings.

[0049] The invention is not limited to a video-type slot machine and is applicable to a device for setting the number of pay lines and the number of bet tokens used in a reel-type slot machine.

What is claimed is:

1. A device incorporated in a slot machine in which each of a plurality of reel sections are cyclically moved in a predetermined direction, and a reward corresponding to a number of bet token per a selected pay line is paid out when a predetermined symbol combination is arranged on at least one selected pay line, for setting a number of selected pay line and a number of bet token per a selected pay line, comprising:

a selector, which selects either the number of selected pay line or the number of bet token as a setting object;

a display device, which displays the number of selected pay line and the number of bet token; and

a setting provider, which updates a number of the setting object by incrementing or decrementing manner.

2. The device as set forth in claim 1, wherein the display device is a light-emitting diode device.

3. The device as set forth in claim 1, wherein the display device is a monitor device which displays the reel sections.

4. The device as set forth in claim 1, wherein the display device is a liquid crystal display device.

5. The device as set forth in claim 1, wherein:

the display device displays numbers associated with each pay line when the number of selected pay line is selected as the setting object; and

the setting provider specifies at least one number of the pay line to determine the number of selected pay line.

6. The device as set forth in claim 1, wherein the setting provider increments or decrements either the number of selected pay line or the number of bet token one by one.

7. A method used in a slot machine in which each of a plurality of reel sections are cyclically moved in a predetermined direction, and a reward corresponding to a number of bet token per a selected pay line is paid out when a predetermined symbol combination is arranged on at least one selected pay line, for setting a number of selected pay line and a number of bet token per a selected pay line, comprising the steps of:

selecting either the number of selected pay line or the number of bet token as a setting object; and

updating a number of the setting object by incrementing or decrementing manner, while displaying an updated number of the setting object.

\* \* \* \* \*