

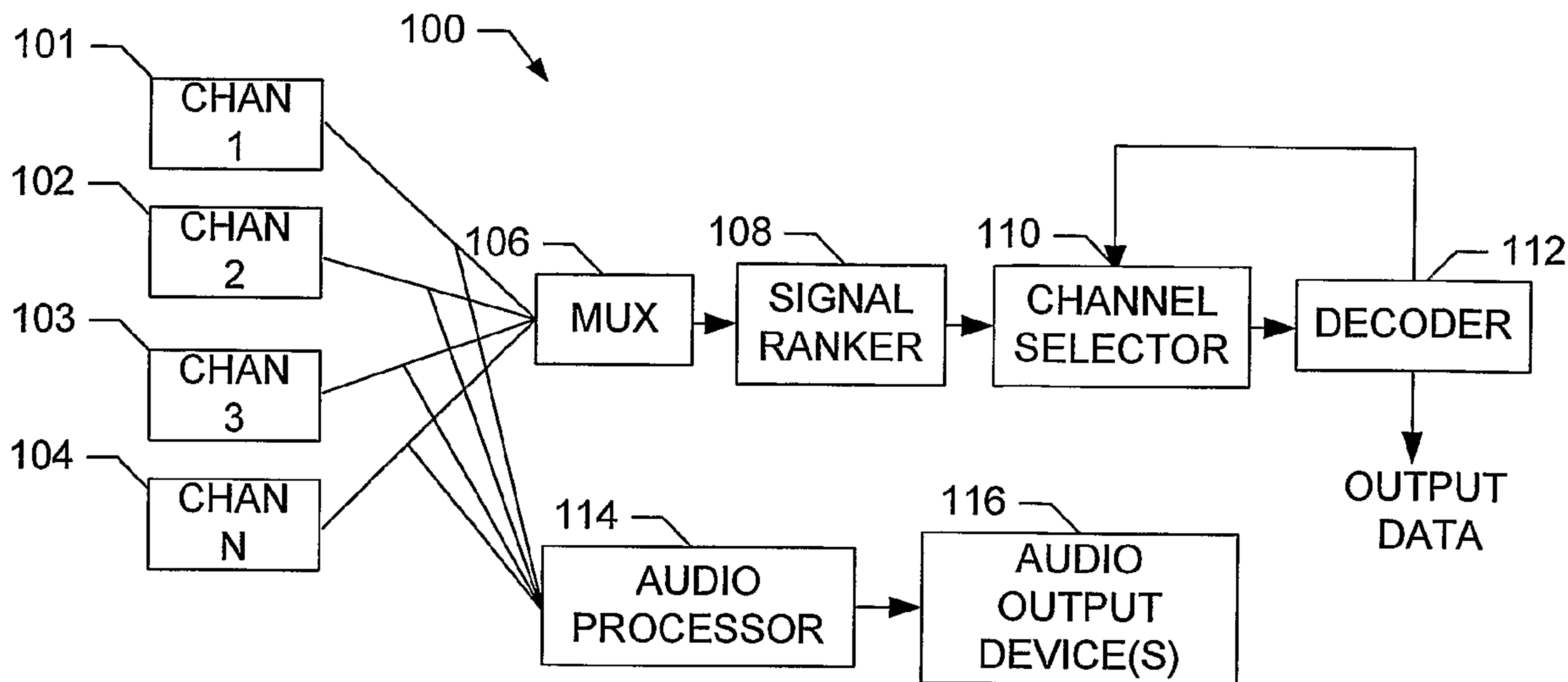

(86) Date de dépôt PCT/PCT Filing Date: 2003/10/07
 (87) Date publication PCT/PCT Publication Date: 2005/05/19
 (85) Entrée phase nationale/National Entry: 2006/04/07
 (86) N° demande PCT/PCT Application No.: US 2003/031697
 (87) N° publication PCT/PCT Publication No.: 2005/046286

(51) Cl.Int./Int.Cl. *H04R 5/00* (2006.01),
G10L 19/00 (2006.01), *G06F 17/00* (2006.01)
 (71) Demandeur/Applicant:
NIELSEN MEDIA RESEARCH, INC., US
 (72) Inventeurs/Inventors:
WRIGHT, DAVID H., US;
NELSON, DANIEL, US;
SCHWERER, RONALD G., US
 (74) Agent: RIDOUT & MAYBEE LLP

(54) Titre : PROCÉDES ET APPAREILS D'EXTRACTION DE CODES D'UNE PLURALITE DE CANAUX
 (54) Title: METHODS AND APPARATUS TO EXTRACT CODES FROM A PLURALITY OF CHANNELS



(57) **Abrégé/Abstract:**

Methods and apparatus to extract audio codes are disclosed. An example method includes receiving signals on a plurality of channels (101-104) and ranking the signals based on at least one characteristic of the signals via a signal ranker (108). A first channel from the plurality of channels is selected based upon the ranking of the signals via a channel selector (110). The example method further include determining whether a first signal on the first channel includes at least one code and extracting the at least one code from the first signal when the first signal includes the at least one code.

(12) INTERNATIONAL APPLICATION PUBLISHED UNDER THE PATENT COOPERATION TREATY (PCT)

(19) World Intellectual Property
Organization
International Bureau



(43) International Publication Date
19 May 2005 (19.05.2005)

PCT

(10) International Publication Number
WO 2005/046286 A1

- (51) International Patent Classification⁷: **H04R 5/00**, G06F 17/00, G10L 19/00
- (21) International Application Number: PCT/US2003/031697
- (22) International Filing Date: 7 October 2003 (07.10.2003)
- (25) Filing Language: English
- (26) Publication Language: English
- (71) Applicant (for all designated States except US): **NIELSEN MEDIA RESEARCH, INC.** [US/US]; 150 N. Martingale Road, Schaumburg, IL 60173 (US).
- (72) Inventors; and
- (75) Inventors/Applicants (for US only): **WRIGHT, David, H.** [US/US]; 221 North Mars Avenue, Clearwater, FL 33755 (US). **NELSON, Daniel** [US/US]; 12562 Leatherleaf Drive, Tampa, FL 33626 (US). **SCHWERER, Ronald, G.** [US/US]; 517 Belle Isle Avenue, Belleair Beach, FL 33786 (US).
- (74) Agent: **ZIMMERMAN, Mark, C.**; Grossman & Flight, LLC, 20 N. Wacker Drive, Suite 4220, Chicago, IL 60606 (US).
- (81) Designated States (national): AE, AG, AL, AM, AT, AU, AZ, BA, BB, BG, BR, BY, BZ, CA, CH, CN, CO, CR, CU, CZ, DE, DK, DM, DZ, EC, EE, EG, ES, FI, GB, GD, GE, GH, GM, HR, HU, ID, IL, IN, IS, JP, KE, KG, KP, KR, KZ, LC, LK, LR, LS, LT, LU, LV, MA, MD, MG, MK, MN, MW, MX, MZ, NI, NO, NZ, OM, PG, PH, PL, PT, RO, RU, SC, SD, SE, SG, SK, SL, SY, TJ, TM, TN, TR, TT, TZ, UA, UG, US, UZ, VC, VN, YU, ZA, ZM, ZW.
- (84) Designated States (regional): ARIPO patent (GH, GM, KE, LS, MW, MZ, SD, SL, SZ, TZ, UG, ZM, ZW), Eurasian patent (AM, AZ, BY, KG, KZ, MD, RU, TJ, TM), European patent (AT, BE, BG, CH, CY, CZ, DE, DK, EE, ES, FI, FR, GB, GR, HU, IE, IT, LU, MC, NL, PT, RO, SE, SI, SK, TR), OAPI patent (BF, BJ, CF, CG, CI, CM, GA, GN, GQ, GW, ML, MR, NE, SN, TD, TG).
- Published:**
— with international search report
- For two-letter codes and other abbreviations, refer to the "Guidance Notes on Codes and Abbreviations" appearing at the beginning of each regular issue of the PCT Gazette.

(54) Title: METHODS AND APPARATUS TO EXTRACT CODES FROM A PLURALITY OF CHANNELS

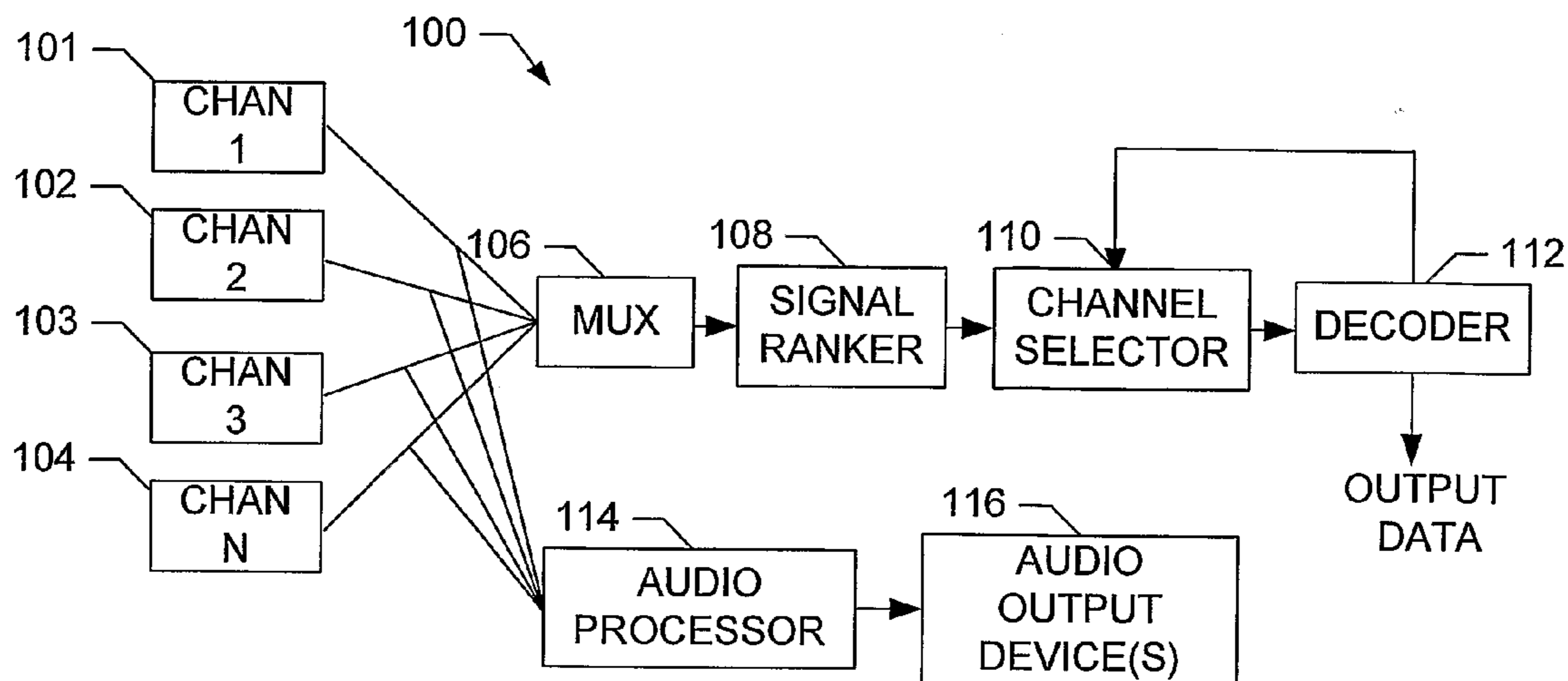

(57) Abstract: Methods and apparatus to extract audio codes are disclosed. An example method includes receiving signals on a plurality of channels (101-104) and ranking the signals based on at least one characteristic of the signals via a signal ranker (108). A first channel from the plurality of channels is selected based upon the ranking of the signals via a channel selector (110). The example method further include determining whether a first signal on the first channel includes at least one code and extracting the at least one code from the first signal when the first signal includes the at least one code.

WO 2005/046286 A1

METHODS AND APPARATUS TO EXTRACT CODES FROM A PLURALITY OF CHANNELS

TECHNICAL FIELD

[0001] The present disclosure relates to decoding systems and, more particularly, to methods and apparatus to extract codes from a plurality of channels.

BACKGROUND

[0002] It is known to add or embed codes in broadcast audio and/or video and/or vertical blanking interval signals. For example, codes may be embedded in television and/or radio broadcasts and/or in pre-recorded audio or video content. In the field of audience metering, codes can be added to audio and/or video signals for the purpose of, for example, identifying programs and/or the distributor(s) that are broadcasting the programs, identifying commercials and promotional announcements, and the like.

[0003] Codes that are added to audio signals can be reproduced in the audio signal output by a speaker. Accordingly, these arrangements offer the possibility of non-intrusively intercepting and decoding the codes with equipment that uses microphonic inputs. For example, these systems enable measuring broadcast audiences by the use of portable metering equipment carried by panelists.

[0004] Audio codes are inserted at low intensities to prevent the codes from distracting a listener of program audio and, therefore, such codes can be vulnerable to various signal processing operations. Consequently, these approaches to encoding a broadcast audio signal may not be compatible with current and proposed digital audio standards, particularly those employing signal compression methods that can reduce the dynamic range of a signal. Dynamic range reduction processing of an audio signal may delete or damage an audio code inserted in the audio signal. In this regard, it is particularly important for an audio code to survive compression and subsequent de-compression carried out by, for example, the DolbyTM Digital Audio Code Number 3 (AC-3) Surround Sound algorithm or by one of the algorithms recommended in the Moving Picture Experts Group (MPEG) standards (e.g., MPEG-1, MPEG-2, MPEG-4, and the like).

[0005] Systems and methods for adding an inaudible code to an audio signal and subsequently retrieving that code in a manner that is compatible with current and proposed

digital audio standards are known. In one such system, an encoder is arranged to add a binary code bit to a signal block by selecting, within the signal block, (i) a reference frequency within the predetermined signal bandwidth, (ii) a first code frequency having a first predetermined offset from the reference frequency, and (iii) a second code frequency having a second predetermined offset from the reference frequency. The spectral amplitude of the signal at the first code frequency is increased so as to render the spectral amplitude at the first code frequency a maximum in its neighborhood of frequencies and is decreased at the second code frequency so as to render the spectral amplitude at the second code frequency a minimum in its neighborhood of frequencies. A decoder can be arranged to decode the binary bit.

[0006] However, the extraction of audio codes from audio signals in such digital-audio-compatible systems requires considerable processing power, because complicated mathematical operations are used for code extraction. If several channels exist, it may be necessary to extract the audio codes from the numerous channels simultaneously. For example, DOLBY™ Digital AC-3 Surround Sound delivers six separate (discrete) channels of sound. AC-3 includes left, center, and right channels across the front of the room and separate (discrete) left and right surround sound channels. The sixth channel is a Low Frequency Effects Channel that is typically coupled to a sub-woofer or the like. With six separate channels, considerable processing power may be required to extract audio codes from each of the channels simultaneously.

BRIEF DESCRIPTION OF THE DRAWINGS

[0007] FIG. 1 is a block diagram of an example code extraction system.

[0008] FIG. 2 is a block diagram of an example multiplexer of FIG. 1.

[0009] FIG. 3 is a flow chart of an example code extraction process.

[0010] FIG. 4 is a flow chart of a second example code extraction process.

[0011] FIG. 5 is a flow chart of a third example code extraction process.

DETAILED DESCRIPTION

[0012] In the example of FIG. 1, a code extraction system 100 receives signals from a plurality of channels 101-104. The channels may be audio channels, video channels or any

other suitable channels through which signals or information may be exchanged. In general, the channels 101-104 can be any type of communications path between two or more devices that are each capable of carrying information, be it audio information, video information or any other information. The information passed through the channels 101-104 may be in digital or analog form. Although only four channels 101-104 are shown in FIG. 1, the number of channels coupled to the system 100 may be as few as one and as many as six or more. For example, if the channels are audio channels, a stereo audio system includes two audio channels and a Dolby™ surround system using AC-3 audio processing uses six audio channels (front left, right and center; rear left and right; and bass audio).

[0013] In practice, the channels 101-104 may be generated from a digital television bitstream. For example, a digital television bitstream may be de-multiplexed into its constituent audio, video and metadata components. The audio component, for example, may then be further de-multiplexed into a number of audio channels. The de-multiplexing operations may be carried out by a digital television, commercially-available television reception card that may be installed into a personal computer (PC), or custom receiver hardware. In the alternative, the channels 101-104 may be provided by hardware (e.g., a set top box) having a Sony/Philips Digital Interface (S/PDIF), which is an output through which digital audio data may be passed in a channelized format.

[0014] Some, none, or all of the channels 101-104 may contain information having identification codes embedded therein. The identification codes may be, for example, audio codes. The audio codes may be added to an audio signal using any method for encoding audio signals. For example, the broadcast encoding methods described in, for example, U.S. Patents 5,450,490; 5,642,111; 5,764,763; and 6,272,176, the disclosures of each of which are hereby incorporated by reference in their entireties, can be used to insert or otherwise encode an audio code in an audio signal. However, any method for encoding a broadcast signal with an identification code can be used. By way of example, audio codes can be inserted into television audio content by program creators, broadcasters, final distributors, television networks, and the like. Although the codes could be any type of identification codes and do not have to be audio codes, the remainder of the description is directed, for ease of illustration, to the extraction of audio codes contained in audio channels. However, those having ordinary skill in the art will readily recognize that such a description is merely an

example, and identification codes could be in any other channel and/or signal types than audio channels and signals. Accordingly, this disclosure should not be considered as limited to audio channels and/or audio codes, but as setting forth example code extraction systems, methods, and articles of manufacture.

[0015] The example system 100 includes a multiplexer 106, a signal ranker 108, a channel selector 110, a decoder 112, an audio processor 114, and audio output devices 116. It will be recognized by persons of ordinary skill in the art and will be apparent from the description below, that the term “multiplexer” as used herein is a generic term that describes any device that can perform multiplexing and/or de-multiplexing. The channels 101-104 are coupled both to the multiplexer 106 and the audio processor 114.

[0016] The multiplexer 106 can be any type of multiplexer that is capable of multiplexing and/or de-multiplexing signals, such as, for example, audio or video signals. The multiplexer 106 receives the channels 101-104 and de-multiplexes the information in the channels 101-104. The information from the multiplexer 106 passes to the signal ranker 108.

[0017] In general, the signal ranker 108 ranks the signals according to characteristic(s) of the signals in the channels 101-104. The signals may be ranked through a number of possible different techniques disclosed herein, such as by determining which channel or channels have the best signal quality.

[0018] The ranked signals pass to the channel selector 110, where a channel is selected for decoding based on the ranking performed by the signal ranker 108. For example, the channel selector 110 may select the channel ranked highest by the signal ranker 108.

[0019] Either signals selected by the channel selector 110 or codes extracted therefrom pass to the decoder 112, which decodes the codes and outputs the same. As the decoder 112 decodes the codes passes thereto, the decoder 112 produces a feedback signal that is coupled to the channel selector 110. The feedback signal may be used by the channel selector 110 as an interrupt that causes the channel selector 110 to execute one or more processes described below. For example, the decoder 112 may produce the feedback signal only when the decode quality of the codes being processed by the decoder 112 drops below a certain level. In such an instance, the channel selector 110 may respond by looking for a higher quality channel in

which a code is found and coupling the code from that channel to the decoder 112 to improve the decode quality thereof.

[0020] Collectively, the multiplexer 106, the signal ranker 108, the channel selector 110 and the decoder 112 extract codes from a plurality of channels 101-104 in environments where multiple, potentially encoded, audio streams are present. In general, the disclosed systems, methods, and articles of manufacture are configured to extract information codes dynamically from one or more channels, rather than continuously decoding all of the channels simultaneously.

[0021] Although the multiplexer 106, the signal ranker 108, the channel selector 110 and the decoder 112 are shown in the example of FIG. 1 as being separate devices, those having ordinary skill in the art will readily appreciate that the signal ranker 108 and the channel selector 110 could be implemented as part of the multiplexer 106. Additionally, the multiplexer 106, the signal ranker 108, the channel selector 110 and the decoder 112 could be implemented by instructions on a single hardware unit, such as a PC or the like.

[0022] The audio processor 114 decodes the information in the channels 101-104 to produce audio that is coupled to the audio output devices 116, which may be speakers or the like. For example, if there are six channels of AC-3 audio that are coupled to the audio processor 114 for a program having surround sound audio, the audio processor 114 may decode the six channels of information into six audio signals that are coupled to the six audio output devices 116.

[0023] Although the example of FIG. 1 illustrates N channels being provided to the multiplexer 106, additional hardware and/or software may be provided between the channels 101-104 and the multiplexer 106 to reduce the number of channels from N to a number of channels fewer than N. For example, if a Dolby 5.1 signal having information for six channels is received by a three-channel receiver, certain ones of the six channels may be combined by the receiver to result in a total of three channels of information provided to the multiplexer 106. In such a case, the three channels of information may be processed to extract codes therefrom in the manner disclosed herein.

[0024] An example multiplexer 206 is shown in FIG. 2 as including the functionality of the signal ranker 108 and the channel selector 110. In the illustrated example the multiplexer 206

is implemented by a processor 208 and an associated memory 210. In the example of FIG. 2, the processor 208 receives the channels (e.g., some or all of the audio channels 101-104) and the feedback signal(s) from the decoder 112. The processor 208, which is programmed or configured to carry out tasks described below, processes the channels and extracts codes therefrom and passes the codes to the decoder 112. The processor 208 recognizes the feedback from the decoder 112 and may use the feedback as a cue to execute certain processes or portions of processes. The feedback from the decoder 112 may be an indication of low decode quality, high decode quality or any other suitable metric pertinent to decoding.

[0025] The processor 208 may be, for example, a microprocessor, a microcontroller, any type of PC, a digital signal processor (DSP) an application-specific integrated circuit (ASIC) or the like. Accordingly, the multiplexer 206 may be constructed completely in hardware or in hardware that executes instructions stored in software or firmware.

[0026] The memory 210 may be a programmable read-only memory (PROM), an erasable programmable read-only memory (EPROM), an electrically-erasable programmable read-only memory (EEPROM), flash memory or the like. Alternatively or additionally, the memory 210 may be any type of optical, magnetic, or electronic storage medium that is located either internally or externally to the multiplexer 206. For example, the memory 210 could be read-only memory (ROM), random access memory (RAM), compact disc read-only memory (CDROM), electro-optical memory, magneto-optical memory, or the like. The memory 210 may store, for example, instructions that dictate the operation of the processor 208. Additionally or alternatively, the memory 210 may be used to buffer the contents of one or more of the channels 101-104. For example, as described in detail below, the memory 210 could be used to buffer, for example, ten seconds of the contents of each of the channels 101-104.

[0027] Although shown as separate components in the example of FIG. 2, the processor 208 and the memory 210 could be integrated into a single component. For example, the processor 208 and the memory 210 could be integrated into a single microcontroller having on-board processing and memory components.

[0028] An example process that may be carried out by the processor 208 of the multiplexer 106 is shown in FIG. 3. In this example, the multiplexer 206 receives audio signals from the channels (block 302). The audio signals may be, for example, any type of signal capable of

carrying audio information and capable of being encoded with audio codes. For example, each audio signal can be 16-bit sampled mono data that is sampled at 24 kilohertz (kHz) or 48 kHz. Any number of audio signals can be received on any number of audio channels. In an example, separate audio signals can be received on each audio channel.

[0029] The received signals are then ranked according to characteristics that are correlated with audio code fidelity (block 304). The audio signals received from the channels 101-104 may be ranked, ordered, or otherwise graded based on one or any combination of characteristics or features of the audio signals. Characteristics according to which the audio signals may be graded may include signal amplitude, signal energy, signal strength, signal to noise ratio (SNR), a history of a percentage of time that the amplitude or energy of the signals exceeds a threshold and the number of times an audio signal has been successfully decoded to yield an audio code. Alternatively, the characteristic used to rank signals may include certain aspects of the frequency spectrum of the audio signals.

[0030] If audio signal amplitude and/or strength of the signals are used to characterize the signal(s), any technique for determining the amplitude and/or signal strength of a signal can be used. Various techniques for determining signal energy are disclosed, for example, in U.S. Patent No. 5,170,437, the entire disclosure of which is hereby incorporated by reference in its entirety. Of course, other techniques for determining signal energy may alternatively be used.

[0031] To rank, order or otherwise grade the signals, the characteristics or features, or any combination thereof, are measured or otherwise determined for each received audio signal. For example, the amplitude of each received audio signal can be determined. Once determined, the characteristic(s) or feature(s) can be used to rank or order the audio signals. To perform the ranking, for example, each audio signal can be assigned a value, percentage or any other numerical designation that is equivalent to or representative of the measured value of the characteristic(s) or feature(s). For example, if audio signal amplitude is calculated for each signal, the audio signals can be ranked in order of, for example, largest audio signal amplitude to smallest audio signal amplitude. The audio signals can be ranked in any increasing or decreasing order of the characteristic(s) or feature(s) measured, so long as the audio signal with the largest occurrence of the given characteristic(s) or feature(s) can

be determined relative to the next largest occurrence of the given characteristic(s) or feature(s), relative to the third largest occurrence, etc.

[0032] The characteristics by which the ranking of audio signals is performed (block 304) may be determined by the multiplexer 206 or could be determined by any other component. In an example system in which the characteristic(s) are passed to the multiplexer 206 by another device, the multiplexer 206 would then rank the audio signal based on the characteristics passed thereto.

[0033] After the audio signals have been ranked (block 304), the multiplexer 206 selects an audio channel to be processed based on the rankings (block 306). The selected audio channel may be the audio channel having the signal(s) with the highest signal strength, the highest audio level or, more generally, the audio channel having an audio signal with the best ranking, regardless of the characteristic by which the audio signal are ranked. As used herein, to "select" an audio channel is to create a communication path or connection between the desired channel and a device. Additionally or alternatively, selection may mean that a particular audio channel or audio signal will be further processed by the multiplexer 206.

[0034] Once an audio channel has been selected (block 306), the multiplexer 206 may, optionally, buffer one or more of the unselected channels in the memory 210 (block 308). For example, the multiplexer 206 may buffer ten seconds of audio signals from the audio channels corresponding to the audio signals having the second and third highest rankings (provided that the audio channel corresponding to the highest ranked signal was selected).

[0035] Buffering audio signals from one or more unselected channels is advantageous in that, if the selected signal is of poor quality or does not include a detectable audio code, one of the buffered signals may be used as a backup. For example, if the multiplexer 206 searches for audio codes in the highest ranked channel for ten seconds and is unable to find audio codes therein, the multiplexer 206 may, in effect, travel back in time and analyze buffered 10 seconds of another audio channel to determine if the buffered channel included an audio code. Buffering may be particularly advantageous in situations in which audio channels are being scanned for an audio code corresponding to a 15 second television commercial. If the multiplexer 206 and the decoder 112 cannot find an audio code in a selected audio channel for 10 seconds, there is jeopardy that the multiplexer 206 and the decoder 112 will miss the occurrence of the commercial. However, if ten seconds of other

audio channels are buffered, the multiplexer 206 and the decoder 112 may evaluate the buffered channels for the occurrence of an audio code corresponding to the commercial. While advantageous in certain aspects, like the other block of the example process of FIG. 3, the buffering (block 308) need not be carried out and can be eliminated.

[0036] After buffering of the unselected channels (block 308) or, if buffering is not performed, after the selection of an audio channel (block 306), it is determined if the audio signal on the selected audio channel includes an audio code (block 310). Any method for determining or otherwise detecting the existence of an audio code in an audio signal can be used to determine whether at least one audio code is present. For example, the audio signal on the selected audio channel may be fully or partially decoded to determine if an audio code is present. Example techniques for decoding (either fully or partially) the audio signal are disclosed in, for example, U.S. Patents 5,450,490, 5,642,111, 5,764,763, and 6,272,176, which are incorporated herein by reference.

[0037] The multiplexer 206 may itself determine if the signals on the selected audio channel include audio codes. In the alternative, the multiplexer 206 may pass the audio signal from the selected channel to another device (e.g., a decoder) that is capable of decoding or otherwise extracting audio codes from audio signals using such decoding methods. If performed by another device, the results of the detection or decoding process can be sent or fed back to the multiplexer 206. The information received by the multiplexer 206 can be used by the multiplexer to determine whether the audio signal on the selected channel includes an audio code. For example, if a decoded audio code is fed back to the multiplexer 206 from, for example, an audio code decoder (e.g., the decoder 112), the multiplexer 206 can determine if the audio signal includes an audio code.

[0038] A finite period of time will be allotted for determining if the selected audio channel includes an audio code. Any time interval that is predetermined or determined on the fly can be used, depending on the desired response of the system. If no audio codes are decoded from the selected audio channel (either by the multiplexer 206 or from feedback from the audio code decoder 112) within the time interval, the multiplexer 206 may determine that no audio codes are present in the audio signal. Accordingly, the time period sets the maximum time limit by which an audio code must be found. If an audio code is not found within the allotted time period, the multiplexer 206 will conclude that audio codes are not present on the

selected audio channel. Audio codes may not be present in an audio signal for numerous reasons. For example, for television audio content, if the audio content is silent (i.e., there is no audio signal for certain intervals of time) or the audio content is not encoded with an audio code, an audio code will not be present.

[0039] If audio codes are not found within the selected channel (block 312) and there are more channels remaining in the ranking that have not been used (block 313), control returns to block 306, where another audio channel is selected. When another audio channel is selected (block 306), such a selection may include selecting one or more channels stored in the buffer or memory 210. The selection (block 306) may be based on the ranking that was previously calculated (block 304). For example, the audio channel having the second highest rank may be selected. If the channel having the second highest rank does not include an audio code (block 310), the third-ranked audio channel may be selected, and so on until an audio code is found in the audio signal of a selected audio channel. In other words, control continues to loop through blocks 306-312 until audio codes are detected and/or every channel has been checked without discovery of an audio code. In no audio codes are detected in any channel, control returns to block 302. If there are no more channels remaining the ranking that have not been used (block 313), control returns to block 302.

[0040] Conversely, if it is determined that the audio signal does include an audio code (block 312), the multiplexer 206 extracts the audio code(s) from the audio signal (block 314). Any method for extracting or otherwise decoding audio code(s) from an audio signal can be used, such as that described in, for example, U.S. Patents 5,450,490, 5,642,111, 5,764,763, and 6,272,176, which have been incorporated by reference herein. However, any method for decoding an identification code from a broadcast signal can be used. The audio code extraction can be performed by, for example, the multiplexer 206 or the decoder 112.

[0041] Once decoded, the extracted audio code(s) can be used by the multiplexer 206, the decoder 112, or passed along to any other device or process for subsequent processing. For example, the extracted audio code(s) can be optionally used to identify the content of the audio signals, e.g., the program content of a television program. For example, the extracted audio code(s) can be optionally used to identify a distributor (e.g., the final distributor) of the audio signals.

[0042] As an alternative to the process of FIG. 3, the multiplexer 206 and, more particularly, the processor 208 of the multiplexer 206, may implement the example process shown in FIG. 4. The process of FIG. 4 is similar to the process of FIG. 3 in as much as both processes select a channel based on signal characteristics and determine if any signal on the selected channel includes codes. If any signal includes a code, the multiplexer 206 extracts the code(s) and passes the extracted code(s) to the decoder 112 for processing. In the alternative, the code extraction may be carried out by the decoder 112. As explained below, the processes of FIG. 3 and FIG. 4 differ in how the audio channels are selected for processing.

[0043] The example process of FIG. 4 begins by monitoring signals on the channels (block 402). For example, separate audio signals can be monitored on each channel. As will be readily appreciated by those having ordinary skill in the art, any number of audio signals on any number of audio channels can be monitored. The monitoring may include monitoring the amplitude of the audio on a channel, monitoring the energy of an audio signal, monitoring the SNR (signal-to-noise ratio) of a particular channel, etc.

[0044] After or while the audio signals are monitored (block 402), an audio channel is selected based on at least one characteristic of the audio signals that are monitored (block 404). While the example process of FIG. 3 ranked audio signals, the example process of FIG. 4 need not rank or order the audio signals. Rather, the example process of FIG. 4 may merely select an audio channel having acceptable monitored characteristics and need not necessarily select the audio signal or channel having the best ranking.

[0045] After an audio channel is selected (block 404), signals on one or more of the unselected channels may be buffered (block 406). As described in conjunction with the example process of FIG. 3, buffering is advantageous, but not necessary. If, however, buffering is performed (block 406) the multiplexer 206 may, as described below, later use the buffered information to effectively go back in time to determine any codes that may have been missed while the multiplexer 206 was monitoring a channel including information that did not include a code(s) or included a code(s) of poor quality that could not be decoded.

[0046] After the audio channel has been selected (block 404) and any optional buffering is performed (block 406), it is determined if the audio signal on the selected audio channel includes one or more audio codes (block 408). If audio codes are not present (block 410) and

there are more channels in the ranking that have not been used (block 411), a different audio channel is selected (block 404). The selection (block 404) may include selecting signals that are previously buffered (block 406). The operation of the blocks 404-410 will continue to iterate until audio code(s) of acceptable quality are detected in the selected audio signal (block 410). Alternatively, if it is determined that there are no more unused channels in the ranking (block 411), control returns to the block 402. When it is determined that audio code(s) of acceptable quality are present in the audio signal (block 410), the audio code(s) are extracted from the audio signal (block 412). The details of blocks 408-412 may be similar or identical to the details provided in conjunction with blocks 310-314 of FIG. 3.

[0047] A further example process for selecting audio channels is shown in FIG. 5. The example process of FIG. 5 begins when an audio channel is selected (block 502). The selection of an audio channel may be a random selection or may be an ordered selection that may include a ranking of the audio channels according to one or more particular criteria or characteristic(s) of signals on the audio channels. Following the selection of an audio channel (block 502), one or more of the unselected channels are optionally buffered (block 504).

[0048] As noted with respect to the example processes of FIGS. 3 and 4, the buffering of unselected audio channels enables the multiplexer 206 to access information on unselected audio channels, wherein such information was presented on the unselected audio channels at the same time the selected audio channel was processed. Accordingly, buffering of unselected audio channels, which is optional to the process of FIG. 5, enables the multiplexer 206 to recover codes that could have been missed without the use of the buffering.

[0049] After channel selection (block 502) and optional buffering (block 504) an audio signal that is received on the selected channel is compared to a threshold (block 506). For example, any one or more of the energy, amplitude, the SNR or any other relevant characteristics of the selected signal of the selected signal is compared to corresponding thresholds for those characteristics. For example, the SNR and the energy of the selected signal may be respectively compared to SNR and energy thresholds to determine if the characteristics exceed the threshold (block 506).

[0050] If the characteristic(s) of the audio signal do exceed the threshold(s) (block 508), it is determined if the audio signal on the selected channel includes audio codes (block 510). If

audio codes are present in the selected signal (block 512), audio codes are extracted from the audio signal (block 514). The blocks 510-514 may be implemented in a manner similar or identical to the corresponding blocks in FIGS. 3 and 4.

[0051] If the characteristic(s) of the audio signal do not exceed the threshold(s) (block 508) or audio code(s) are not present in the signal (block 512), control returns to block 502, at which point another audio channel is selected. The second selected audio channel could be an audio channel that has been previously buffered (block 504) or could be an audio channel that is presently being received. The second selected audio channel is compared to a threshold (block 506) and, if the threshold is exceeded (block 508), it is determined if the audio channel includes a signal having audio codes therein (block 510). Control loops through blocks 502-512 until a channel is found that includes a signal having a characteristic that exceeds the threshold and includes one or more audio code(s), at which point the audio code(s) are extracted (block 514).

[0052] The example processes of FIGS. 3-5 could be started at particular time intervals or could be started in response to a stimulus. For example, upon power-up of the multiplexer 206, the example processes of FIGS. 3-5 could be performed and an audio channel having audio codes therein could be selected and the audio codes could be extracted therefrom and passed to the decoder 112. The example processes of FIGS. 3-5 would not necessarily need to be executed again until the decoder 112 provides feedback to the multiplexer 206 to indicate that the audio codes being decoded by the decoder 112 are of poor quality. Upon receiving such an indication from the decoder 112, the multiplexer 206 would start one of the example processes of FIG. 3-5 again so that another channel could be selected and the audio codes could be extracted therefrom.

[0053] Although certain example apparatus, methods and articles of manufacture have been described herein, the scope of coverage of this patent is not limited thereto. On the contrary, this patent covers all apparatus, methods and articles of manufacture fairly falling within the scope of the appended claims either literally or under the doctrine of equivalents.

WHAT IS CLAIMED IS:

1. A method to extract codes comprising:
receiving signals on a plurality of channels;
ranking the signals based on at least one characteristic of the signals;
selecting a first channel from the plurality of channels based upon the ranking of the signals;
determining whether a first signal on the first channel includes at least one code;
and
extracting the at least one code from the first signal when the first signal includes the at least one code.
2. A method as defined by claim 1, further comprising:
if the first signal does not include the at least one code, selecting a second channel from the plurality of channels based upon the ranking of the signals; and
determining whether a second signal on the second channel includes the at least one code.
3. A method as defined by claim 2, further comprising extracting the at least one code from the second signal, when the second signal includes the at least one code.
4. A method as defined by claim 2, further comprising buffering a predetermined time interval of the second signal.
5. A method as defined by claim 4, further comprising extracting the at least one code from the buffered predetermined time interval of the second signal, when the second signal includes the at least one code.
6. A method as defined by claim 2, wherein the same at least one code is included in the first and second signals.

7. A method as defined by claim 1, wherein the at least one characteristic of the signals comprises at least one of an amplitude of the signals, a signal energy of the signals and a signal to noise ratio of the signals.

8. A method as defined by claim 1, further comprising identifying a content of the signals based on the extracted at least one code.

9. A method as defined by claim 1, further comprising identifying a distributor of the signals based on the extracted at least one code.

10. A method as defined by claim 1, wherein the signals include audio signals and wherein the at least one code includes an audio code.

11. A method to extract a code, comprising:
 - selecting a first channel from a plurality of channels;
 - receiving a first signal on the first channel;
 - determining whether the first signal exceeds a predetermined threshold of at least one characteristic of signals on the plurality of channels; and
 - if the first signal exceeds the predetermined threshold of the at least one characteristic of the signals:
 - (a) determining whether the first signal includes at least one code; and
 - (b) extracting the at least one code from the first signal.

12. A method as defined by claim 11, further comprising:
 - selecting a second channel from the plurality of channels, when one of the first signal is less than the predetermined threshold of the at least one characteristic of the signals and the at least one code is absent from the first signal;
 - receiving a second signal on the second channel;
 - determining whether the second signal exceeds the predetermined threshold of at least one characteristic of the signals; and
 - determining whether the second signal includes the at least one code.

13. A method as defined by claim 12, further comprising extracting the at least one code from the second signal, when the second signal exceeds the predetermined threshold of the at least one characteristic of the signals and the second signal includes the at least one code.

14. A method as defined by claim 12, wherein the same at least one code is included in the first and second signals.

15. A method as defined by claim 12, further comprising buffering a predetermined time interval of the second signal.

16. A method as defined by claim 15, further comprising extracting the at least one code from the buffered predetermined time interval of the second signal, when the second signal exceeds the predetermined threshold of the at least one characteristic of the signals and the second signal includes the at least one code.

17. A method as defined by claim 11, wherein the at least one characteristic of the signals comprises at least one of an amplitude of the signals, a signal energy of the signals and a signal to noise ratio of the signals.

18. A method as defined by claim 11, further comprising identifying a content of the signals based on the extracted at least one code.

19. A method as defined by claim 11, further comprising identifying a distributor of the signals based on the extracted at least one code.

20. A method as defined by claim 11, wherein the signals include audio signals and wherein the at least one code includes an audio code.

21. A system to extract codes comprising:
a multiplexer to receive signals on a plurality of channels;
a ranker to rank the signals using at least one characteristic of the signals;
a channel selector to select a first channel from the plurality of channels based upon the ranking of the signals; and
a decoder to determine whether a first signal on the first channel includes at least one code and to extract the at least one code from the first signal, when the first signal includes the at least one code.
22. A system as defined by claim 21, wherein if the at least one code is absent from the first signal, the channel selector is configured to select a second channel from the plurality of channels using the ranking of the signals and wherein the decoder is configured to determine whether a second signal on the second channel includes the at least one code.
23. A system as defined by claim 22, wherein the decoder is configured to extract the at least one code from the second signal, when the second signal includes the at least one code.
24. A system as defined by claim 22, wherein the same at least one code is included in the first and second signals.
25. A system as defined by claim 22, wherein the multiplexer is configured to buffer a predetermined time interval of the signals on at least one of a plurality of unselected channels.
26. A system as defined by claim 25, wherein the decoder is configured to extract the at least one code from the buffered predetermined time interval of the second signal, when the second signal includes the at least one code.

27. A system as defined by claim 21, wherein the at least one characteristic of the signals comprises at least one of an amplitude of the signals, a signal energy of the signals and a signal to noise ratio of the signals.

28. A system to extract codes comprising:
a multiplexer to select a first channel from a plurality of channels and to receive a first signal on the first channel, the multiplexer further configured to determine whether the first signal exceeds a predetermined threshold of at least one characteristic of signals on the plurality of channels; and
a decoder for extracting the at least one code from the first signal, when the first signal exceeds the predetermined threshold of the at least one characteristic of the signals and the first signal includes the at least one code.

29. A system as defined by claim 28, wherein the multiplexer is further configured to select a second channel from the plurality of channels, when one of the first signal is less than the predetermined threshold of the at least one characteristic of the signals and the at least one code is absent from the first signal, the multiplexer further configured to receive a second signal on the second channel and to determine whether the second signal exceeds a predetermined threshold of at least one characteristic of the signals and wherein the decoder is further configured to determine whether the second signal includes the at least one code.

30. A system as defined by claim 29, wherein the decoder is configured to extract the at least one code from the second signal, when the second signal exceeds the predetermined threshold of the at least one characteristic of the signals and the second signal includes the at least one code.

31. A system as defined by claim 29, wherein the multiplexer is configured to buffer a predetermined time interval of the signals on at least one of a plurality of unselected channels.

32. A system as defined by claim 29, wherein the same at least one code is included in the first and second signals.

33. A system as defined by claim 29, wherein the at least one characteristic of the signals comprises at least one of an amplitude of the signals, a signal energy of the signals and a signal to noise ratio of the signals.

34. An article comprising a machine-accessible medium having a plurality of machine accessible instructions that, when executed, cause a machine to:

- receive signals on a plurality of channels;
- rank the signals based on at least one characteristic of the signals;
- select a first channel from the plurality of channels based upon the ranking of the signals;
- determine whether a first signal on the first channel includes at least one code;

and

- extract the at least one code from the first signal when the first signal includes the at least one code.

35. An article as defined by claim 34, further comprising machine accessible instructions that, when executed, cause the machine to:

- if the first signal does not include the at least one code, select a second channel from the plurality of channels based upon the ranking of the signals; and
- determine whether a second signal on the second channel includes the at least one code.

36. An article as defined by claim 35, further comprising machine accessible instructions that, when executed, cause the machine to extract the at least one code from the second signal, when the second signal includes the at least one code.

37. An article as defined by claim 35, further comprising machine accessible instructions that, when executed, cause the machine to buffer a predetermined time interval of the second signal.

38. An article as defined by claim 35, further comprising machine accessible instructions that, when executed, cause the machine to extract the at least one code the buffered predetermined time interval of the second signal, when the second signal includes the at least one code.

39. An article as defined by claim 34, further comprising machine accessible instructions that, when executed, cause the machine to identify a content of the signals based on the extracted at least one code.

40. An article as defined by claim 34, further comprising machine accessible instructions that, when executed, cause the machine to identify a distributor of the signals based on the extracted at least one code.

41. An article comprising a machine-accessible medium having a plurality of machine accessible instructions that, when executed, cause a machine to:

- select a first channel from a plurality of channels;
- receive a first signal on the first channel;
- determine whether the first signal exceeds a predetermined threshold of at least one characteristic of signals on the plurality of channels; and
- if the first signal exceeds the predetermined threshold of the at least one characteristic of the signals:
 - (a) determine whether the first signal includes at least one code; and
 - (b) extract the at least one code from the first signal.

42. An article as defined by claim 41, further comprising machine accessible instructions that, when executed, cause the machine to:

- select a second channel from the plurality of channels, when one of the first signal is less than the predetermined threshold of the at least one characteristic of the signals and the at least one code is absent from the first signal;
- receive a second signal on the second channel;
- determine whether the second signal exceeds the predetermined threshold of at least one characteristic of the signals; and
- determine whether the second signal includes the at least one code.

43. An article as defined by claim 42, further comprising machine accessible instructions that, when executed, cause the machine to extract the at least one code from the second signal, when the second signal exceeds the predetermined threshold of the at least one characteristic of the signals and the second signal includes the at least one code.

44. An article as defined by claim 42, further comprising machine accessible instructions that, when executed, cause the machine to buffering a predetermined time interval of the second signal.

45. An article as defined by claim 44, further comprising machine accessible instructions that, when executed, cause the machine to extract the at least one code from a

stored predetermined time interval of the second signal, when the second signal exceeds the predetermined threshold of the at least one characteristic of the signals and the second signal includes the at least one code.

46. An article as defined by claim 41, further comprising machine accessible instructions that, when executed, cause the machine to identify a content of the signals based on the extracted at least one code.

47. An article as defined by claim 41, further comprising machine accessible instructions that, when executed, cause the machine to identify a distributor of the signals based on the extracted at least one code.

1/4

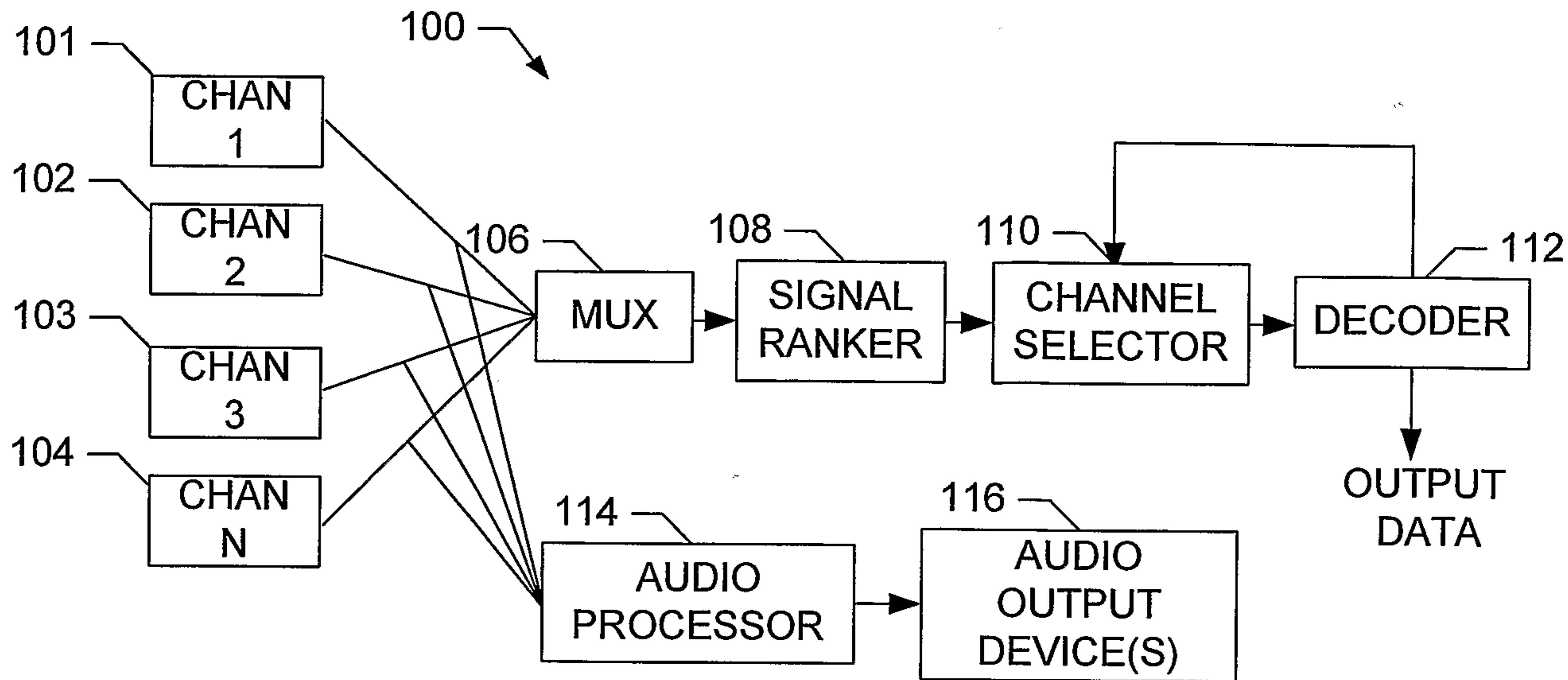

FIG. 1

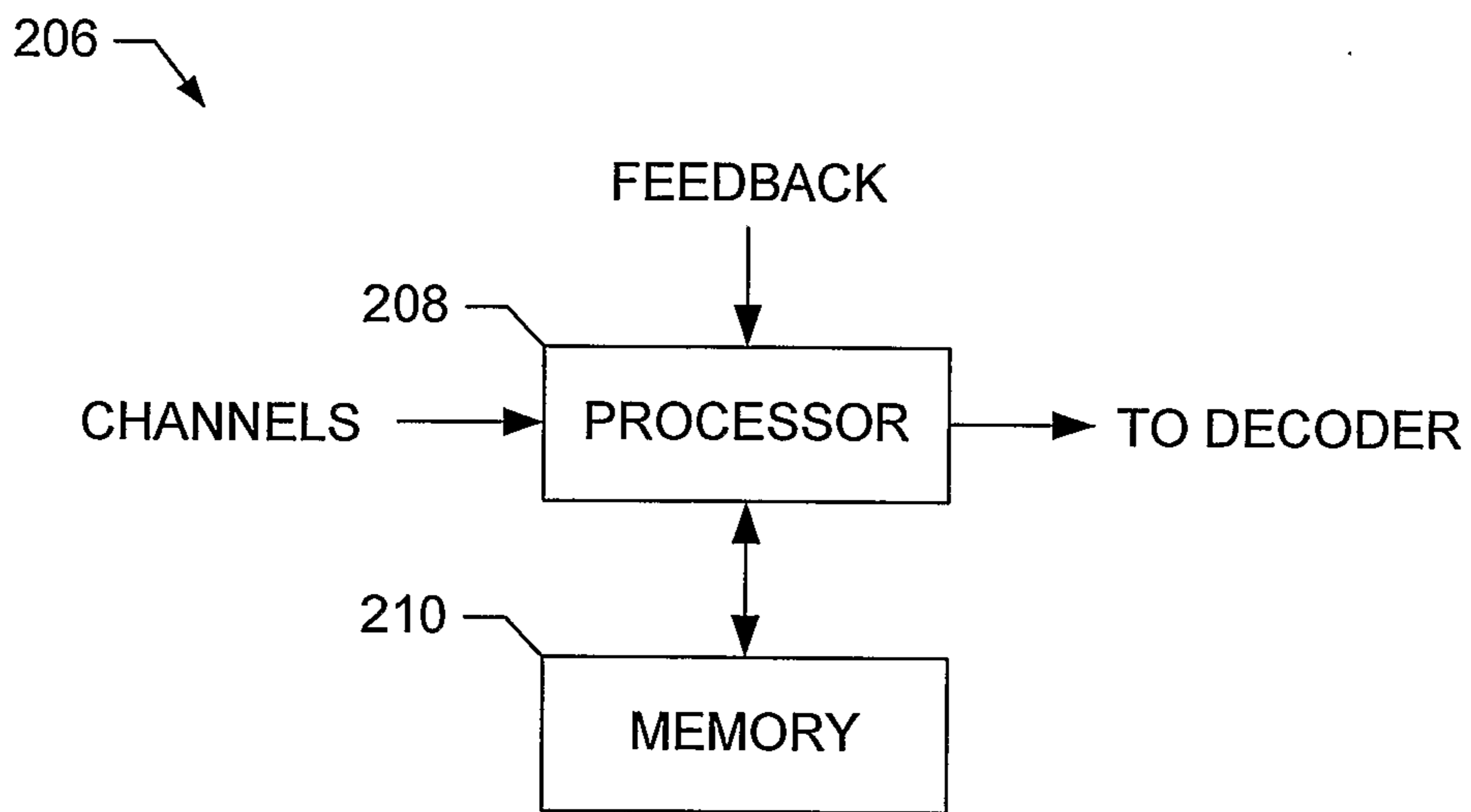
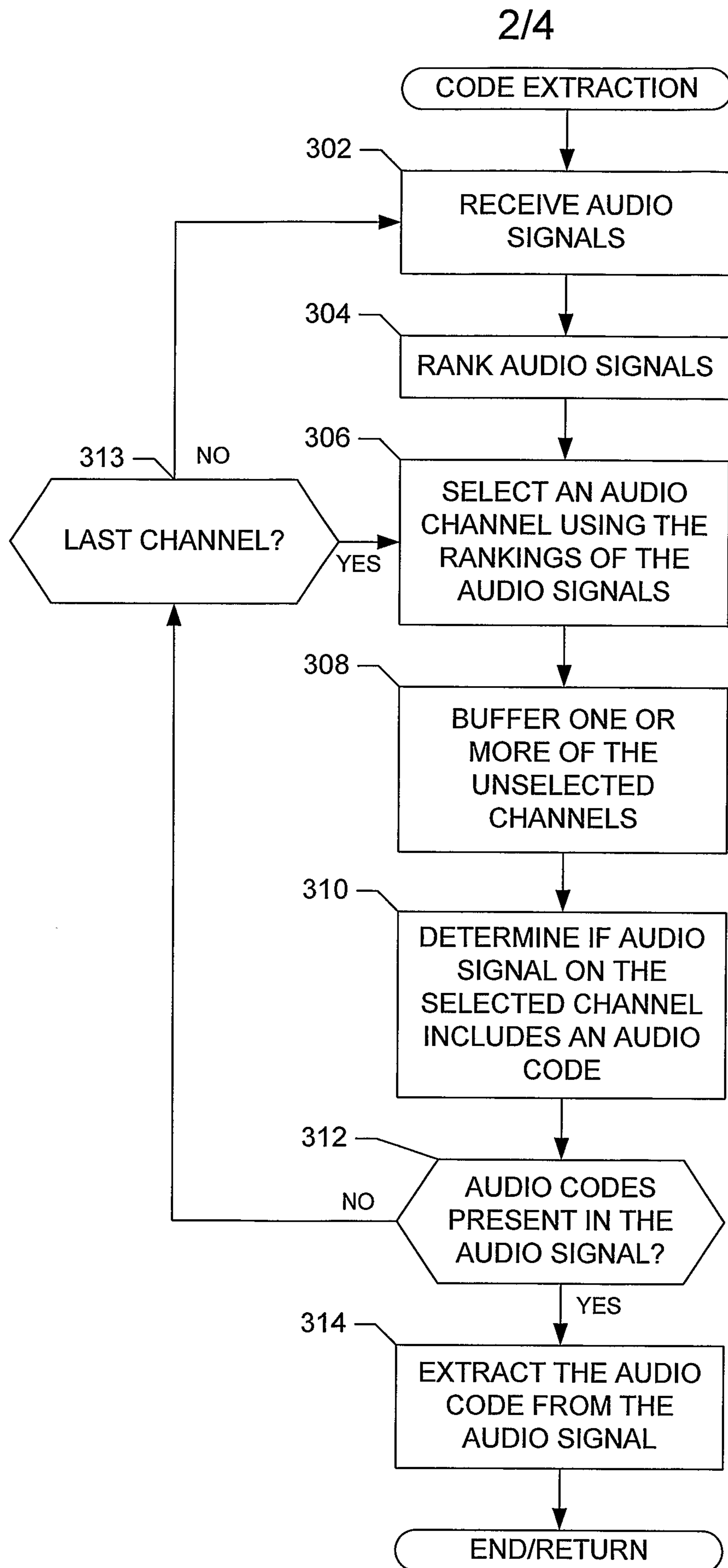

FIG. 2



3/4

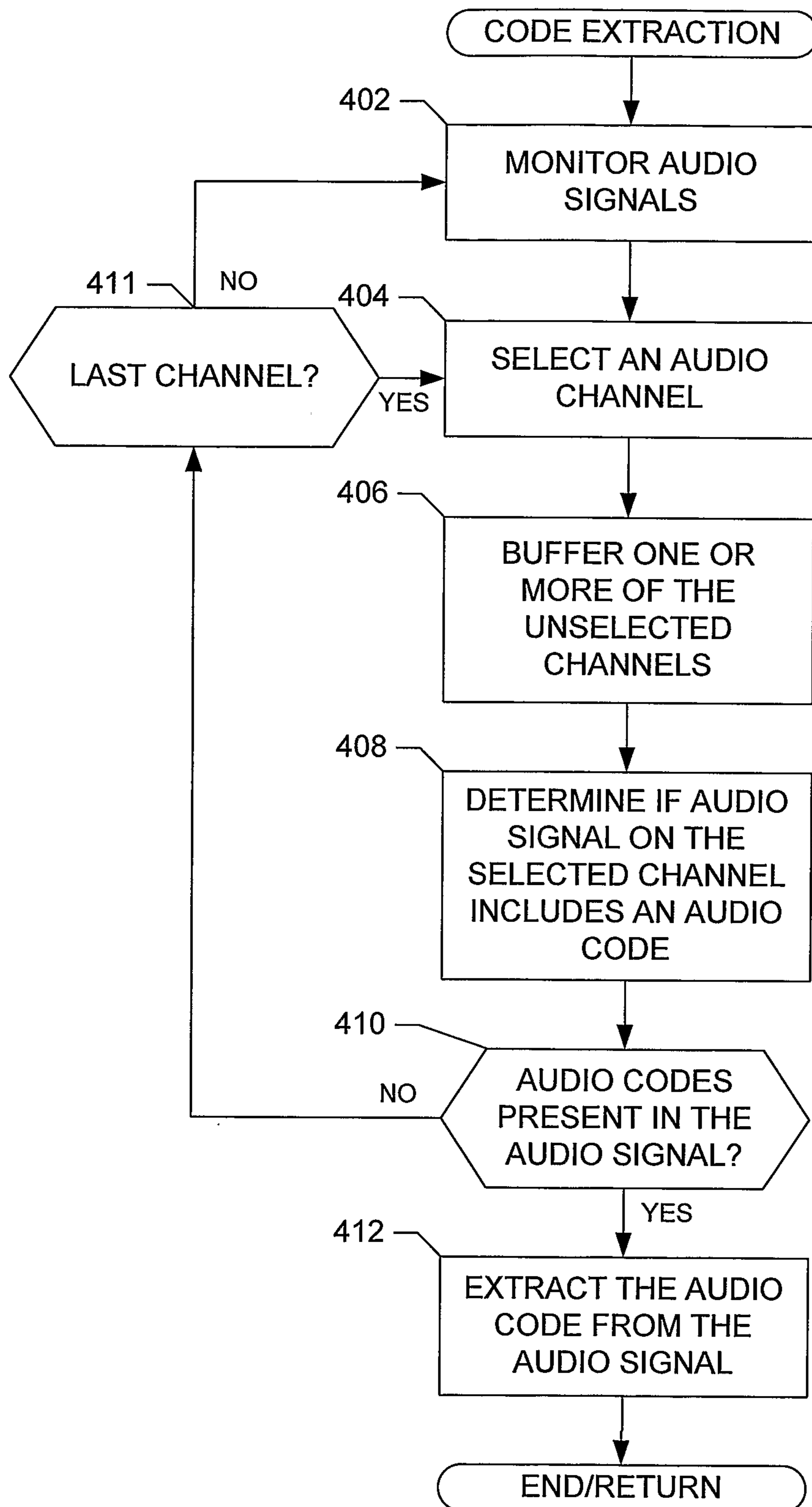

FIG. 4

4/4

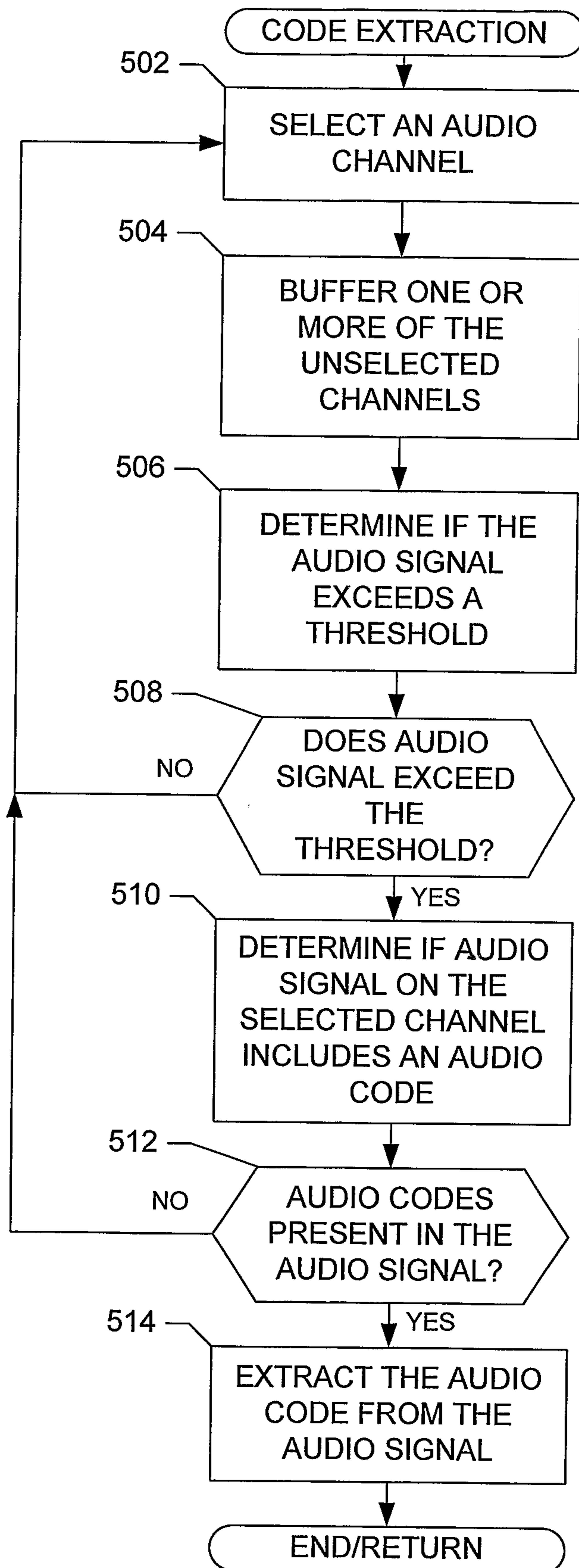

FIG. 5

