



US0D1007242S

(12) **United States Design Patent** (10) **Patent No.:** **US D1,007,242 S**  
**Wnukowski, Jr.** (45) **Date of Patent:** **\*\* Dec. 12, 2023**

- (54) **SHOT CONTAINER**
- (71) Applicant: **Lumberlend Company, LLC**,  
Concord, MA (US)
- (72) Inventor: **Adam Wnukowski, Jr.**, Concord, MA  
(US)
- (73) Assignee: **Thompson Mug Company LLC**,  
Winter Haven, FL (US)
- (\*\*) Term: **15 Years**
- (21) Appl. No.: **29/716,147**

D287,204 S	12/1986	Bierlein	
D334,322 S	3/1993	Huang	
D375,870 S	11/1996	Stonehouse	
D376,284 S	12/1996	Keeley	
D395,575 S	6/1998	Zelle	
D462,294 S *	9/2002	Walsh	D11/146
D488,582 S *	4/2004	Connelly	D26/96
D511,072 S	11/2005	Trombly	
D522,367 S	6/2006	Bakic	
D553,439 S *	10/2007	Bodum	D7/509
D581,739 S *	12/2008	Bodum	D7/509
D599,619 S *	9/2009	Bodum	D7/509
D613,624 S *	4/2010	Bodum	D10/46.2

(Continued)

- (22) Filed: **Dec. 6, 2019**
- (51) **LOC (14) Cl.** ..... **07-01**
- (52) **U.S. Cl.**  
USPC ..... **D7/509**; D10/46.2
- (58) **Field of Classification Search**  
USPC ..... D10/46.2, 46.3; D24/116; D7/691, 682,  
D7/509, 523, 603, 608; D11/152, 142,  
D11/146; D26/9
- CPC ..... B65D 41/26; G01F 19/00-007; A47G  
2019/2277; A47G 19/2205
- See application file for complete search history.

**OTHER PUBLICATIONS**

Postmodern Black Marble Desk Pen Pencil Holder, 1980, 1stDibs,  
[https://www.1stdibs.com/furniture/decorative-objects/desk-accessories/more-desk-accessories/postmodern-black-marble-desk-pen-pencil-holder-circa-1980/id-f\\_24458192/](https://www.1stdibs.com/furniture/decorative-objects/desk-accessories/more-desk-accessories/postmodern-black-marble-desk-pen-pencil-holder-circa-1980/id-f_24458192/) (Year: 1980).\*

(Continued)

*Primary Examiner* — Brett Miller  
(74) *Attorney, Agent, or Firm* — Maxey-Fisher, PLLC;  
Brittany J. Maxey-Fisher

(56) **References Cited**

**U.S. PATENT DOCUMENTS**

272,261 A	2/1883	Jeffords	
852,472 A	5/1907	Tracey	
1,771,186 A *	7/1930	Mock	A47G 19/027 62/530
1,975,522 A *	10/1934	Swobe	F21V 35/00 D26/13
2,899,098 A	8/1959	Gits	
3,394,562 A *	7/1968	Coleman	F25D 3/00 62/457.3
D215,335 S	9/1969	Valis	
3,603,106 A *	9/1971	Ryan	A47J 41/0044 220/592.2
D269,638 S	7/1983	Frye, Jr.	

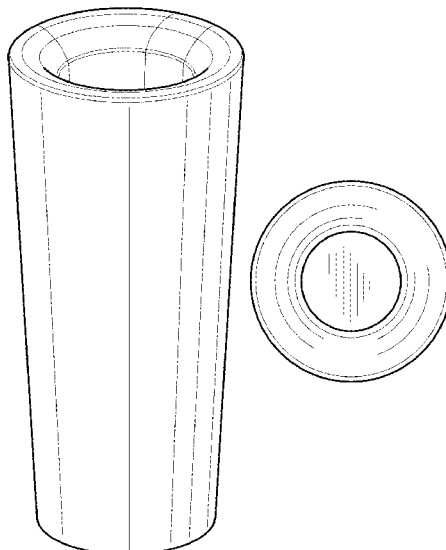
(57) **CLAIM**

The ornamental design for a shot container, as shown and described.

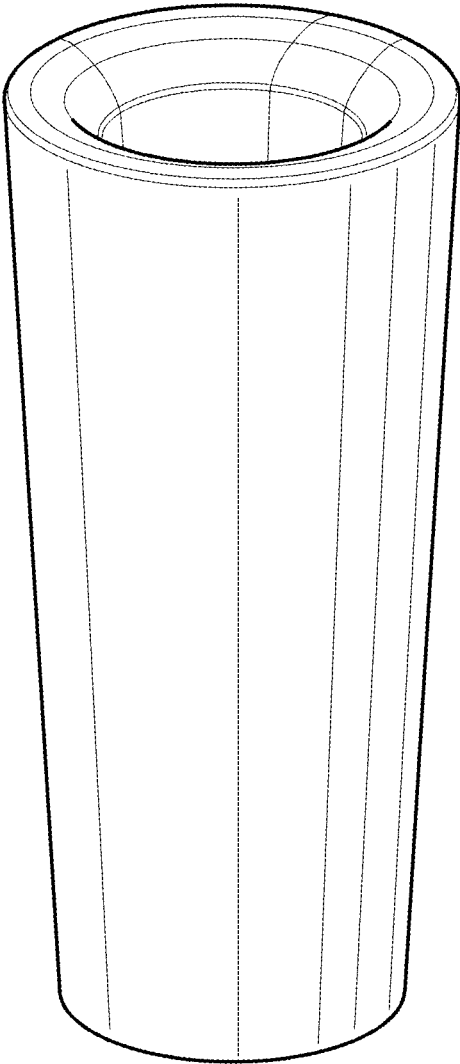
**DESCRIPTION**

FIG. 1 is a perspective view of a shot container in accordance with the present invention;  
FIG. 2 is a front view of the shot container of FIG. 1;  
FIG. 3 is a rear view of the shot container of FIG. 1;  
FIG. 4 is a right side view of the shot container of FIG. 1;  
FIG. 5 is a left side view of the shot container of FIG. 1;  
FIG. 6 is a top view of the shot container of FIG. 1; and,  
FIG. 7 is a bottom view of the shot container of FIG. 1.

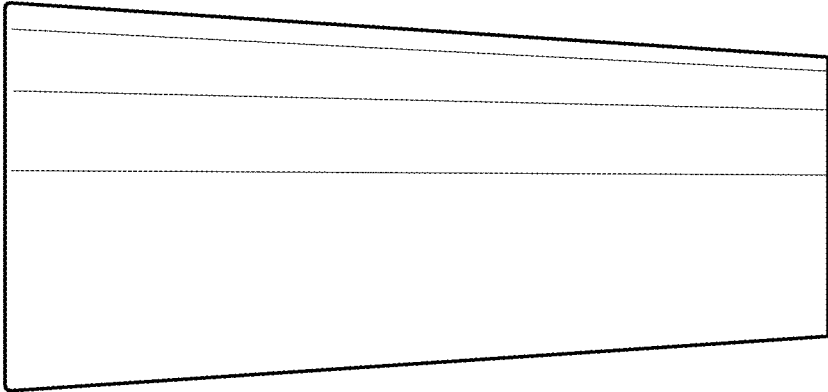
**1 Claim, 3 Drawing Sheets**



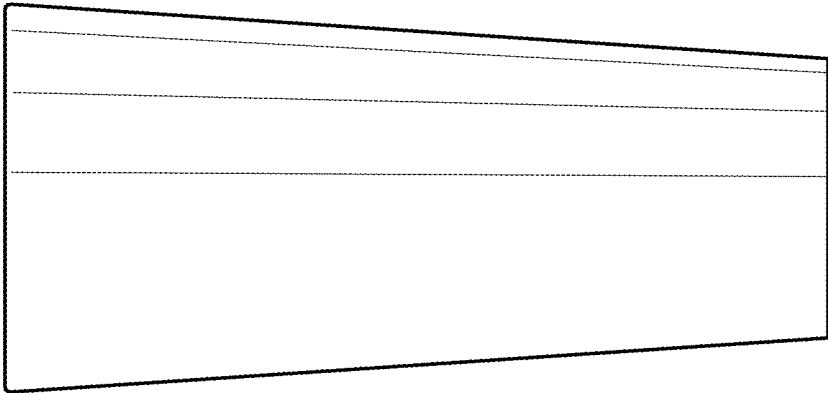




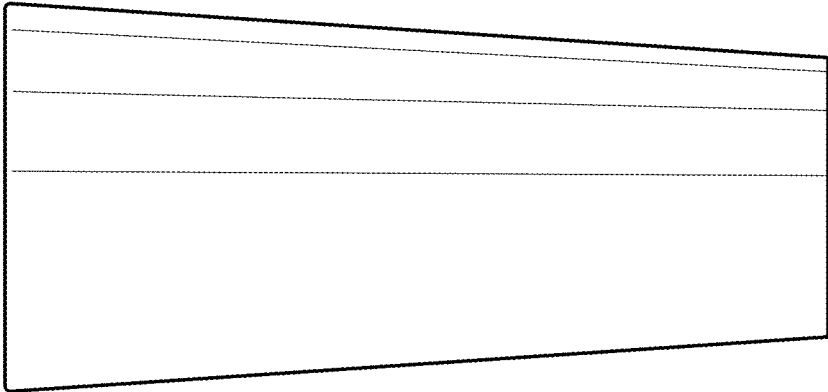
***FIG. 1***



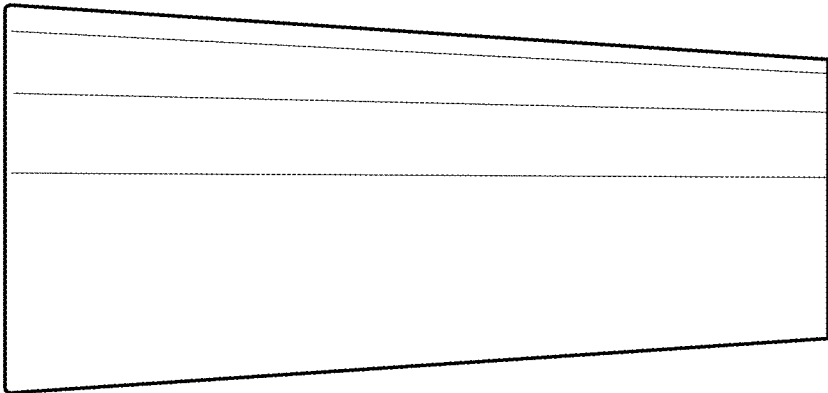
**FIG. 5**



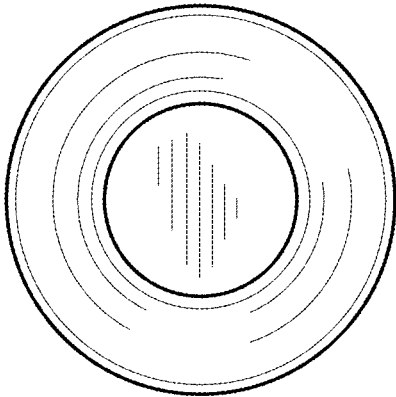
**FIG. 4**



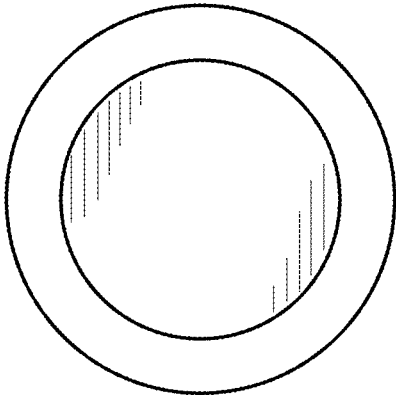
**FIG. 3**



**FIG. 2**



**FIG. 6**



**FIG. 7**