



US00D542931S

(12) **United States Design Patent** (10) **Patent No.:** **US D542,931 S**  
**Pukall et al.** (45) **Date of Patent:** **\*\* May 15, 2007**

(54) **LABORATORY MEASURING DEVICE HOUSING**

(75) Inventors: **Britta Pukall**, Mannedorf (CH);  
**Florian Wasserman**, Zurich (CH)

(73) Assignee: **Roche Diagnostics Operations, Inc.**,  
Indianapolis, IN (US)

(\*\*) Term: **14 Years**

(21) Appl. No.: **29/239,592**

(22) Filed: **Sep. 30, 2005**

(30) **Foreign Application Priority Data**

Mar. 31, 2005	(EP)	00318027-0002
Mar. 31, 2005	(EP)	00318027-0003
Mar. 31, 2005	(EP)	00318027-0004
Mar. 31, 2005	(EP)	00318027-0005
Mar. 31, 2005	(EP)	00318027-0001

(51) **LOC (8) Cl.** ..... **24-01**

(52) **U.S. Cl.** ..... **D24/232; D10/81**

(58) **Field of Classification Search** ..... D10/81,  
D10/46; D24/216-219, 232-234; 356/417,  
356/250, 246; 250/458.1; 382/133; 422/68.1,  
422/82.08, 102, 82.05; 435/4, 69.1, 320.1,  
435/325; 436/172; 530/350; 514/2

See application file for complete search history.

(56) **References Cited**

**U.S. PATENT DOCUMENTS**

D527,464 S \* 8/2006 Ina et al. .... D24/232

**OTHER PUBLICATIONS**

*DNA Engine Opticon® System For Continuous Fluorescence Detection*, Operations Manual (Supports Software Version 1.08), MJ Research; Copyright ©2004, Bio-Rad Laboratories, Incorporated (126 pages).

*Mx3000P Real-Time PCR System* brochure (BR 45) by STRATAGENE® (8 pages).

*Applied Biosystems 7900HT Fast Real-Time PCT System: A Comprehensive Comparison of Standard and Fast System Data*, Data Sheet, Publication 117DA02-01 ©2005, Applied Biosystems (4 pages).

*Exiclear™ Real Time Thermal Block*; Website [http://engineer.com/instruments\\_qper.htm](http://engineer.com/instruments_qper.htm); ©2004 Bioneer Corporation (4 pages).

*COBAS TaqMan 48 Analyzer*, Product Detail Website [http://www.roche-diagnostics.com/products\\_services/cobas\\_taqman48.html](http://www.roche-diagnostics.com/products_services/cobas_taqman48.html); ©2005 Roche Diagnostics (2 pages).

*LightCycler® System*, Product Detail Website [http://www.roche-diagnostics.com/products\\_services/lightcycler.html](http://www.roche-diagnostics.com/products_services/lightcycler.html); ©2005 Roche Diagnostics (2 pages).

*LightCycler® 480 System Advertising Brochure*, 16 pages, [www.roche-applied-science.com/sis/rtpcr/hte/hte\\_docs/lc480\\_final.pdf](http://www.roche-applied-science.com/sis/rtpcr/hte/hte_docs/lc480_final.pdf), 2006.

\* cited by examiner

*Primary Examiner*—Antoine D. Davis

(74) *Attorney, Agent, or Firm*—Barnes & Thornburg LLP

(57) **CLAIM**

The ornamental design for a laboratory measuring device housing, as shown and described.

**DESCRIPTION**

FIG. 1 is a front, right perspective view of a laboratory measuring device housing in accordance with a first embodiment of our new design, with screen portions and other portions of the laboratory measuring device housing being illustrated in broken lines, which broken lines are for illustrative purposes only and form no part of the laboratory measuring device housing;

FIG. 2 is a front, left perspective view of the laboratory measuring device housing shown in FIG. 1;

FIG. 3 is a right-side elevation view of the laboratory measuring device housing thereof;

FIG. 4 is a left-side elevation view of the laboratory measuring device housing thereof;

FIG. 5 is a front elevation view of the laboratory measuring device housing thereof;

FIG. 6 is a top plan view of the laboratory measuring device housing thereof;

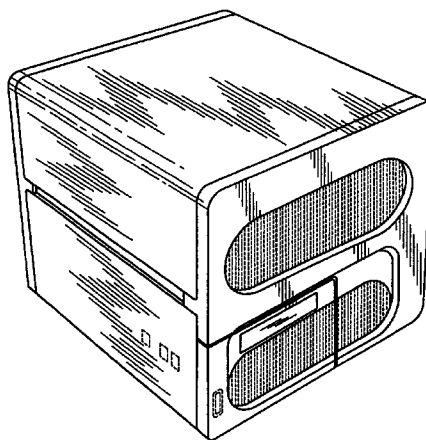

FIG. 7 is a bottom plan view of the laboratory measuring device housing thereof;

FIG. 8 is a rear elevation view of the laboratory measuring device housing thereof;

FIG. 9 is a front, left perspective view of a laboratory measuring device housing in accordance with a second embodiment of our new design, with screen portions and other portions of the laboratory measuring device housing being illustrated in broken lines, which broken lines are for illustrative purposes only and form no part of the laboratory measuring device housing;

FIG. 10 is front, right perspective view of the laboratory measuring device housing shown in FIG. 9;

FIG. 11 is a right-side elevation view of the laboratory measuring device housing shown in FIG. 9;

FIG. 12 is a left-side elevation view of the laboratory measuring device housing shown in FIG. 9;

FIG. 13 is a front elevation view of the laboratory measuring device housing shown in FIG. 9;

FIG. 14 is a rear elevation view of the laboratory measuring device housing shown in FIG. 9;

FIG. 15 is a top plan view of the laboratory measuring device housing shown in FIG. 9;

FIG. 16 is a bottom plan view of the laboratory measuring device housing shown in FIG. 9;

FIG. 17 is a front, left perspective view of a laboratory measuring device housing in accordance with a third embodiment of our new design;

FIG. 18 is front, right perspective view of the laboratory measuring device housing shown in FIG. 17;

FIG. 19 is a right-side elevation view of the laboratory measuring device housing shown in FIG. 17;

FIG. 20 is a left-side elevation view of the laboratory measuring device housing shown in FIG. 17;

FIG. 21 is a front elevation view of the laboratory measuring device housing shown in FIG. 17;

FIG. 22 is an alternative front elevation view of the laboratory measuring device housing shown in FIG. 17;

FIG. 23 is a top plan view of the laboratory measuring device housing shown in FIG. 17;

FIG. 24 is a bottom plan view of the laboratory measuring device housing shown in FIG. 17;

FIG. 25 is a rear elevation view of the laboratory measuring device housing shown in FIG. 17;

FIG. 26 is a front, left perspective view of a laboratory measuring device housing in accordance with a fourth embodiment of our new design;

FIG. 27 is a front, right perspective view of the laboratory measuring device housing shown in FIG. 26;

FIG. 28 is a right-side elevation view of the laboratory measuring device housing shown in FIG. 26;

FIG. 29 is a left-side elevation view of the laboratory measuring device housing shown in FIG. 26;

FIG. 30 is a front elevation view of the laboratory measuring device housing shown in FIG. 26;

FIG. 31 is an alternative front elevation view of the laboratory measuring device housing shown in FIG. 26;

FIG. 32 is a rear elevation view of the laboratory measuring device housing shown in FIG. 26;

FIG. 33 is a top plan view of the laboratory measuring device housing shown in FIG. 26; and,

FIG. 34 is a bottom plan view of the laboratory measuring device housing shown in FIG. 26.

**1 Claim, 23 Drawing Sheets**

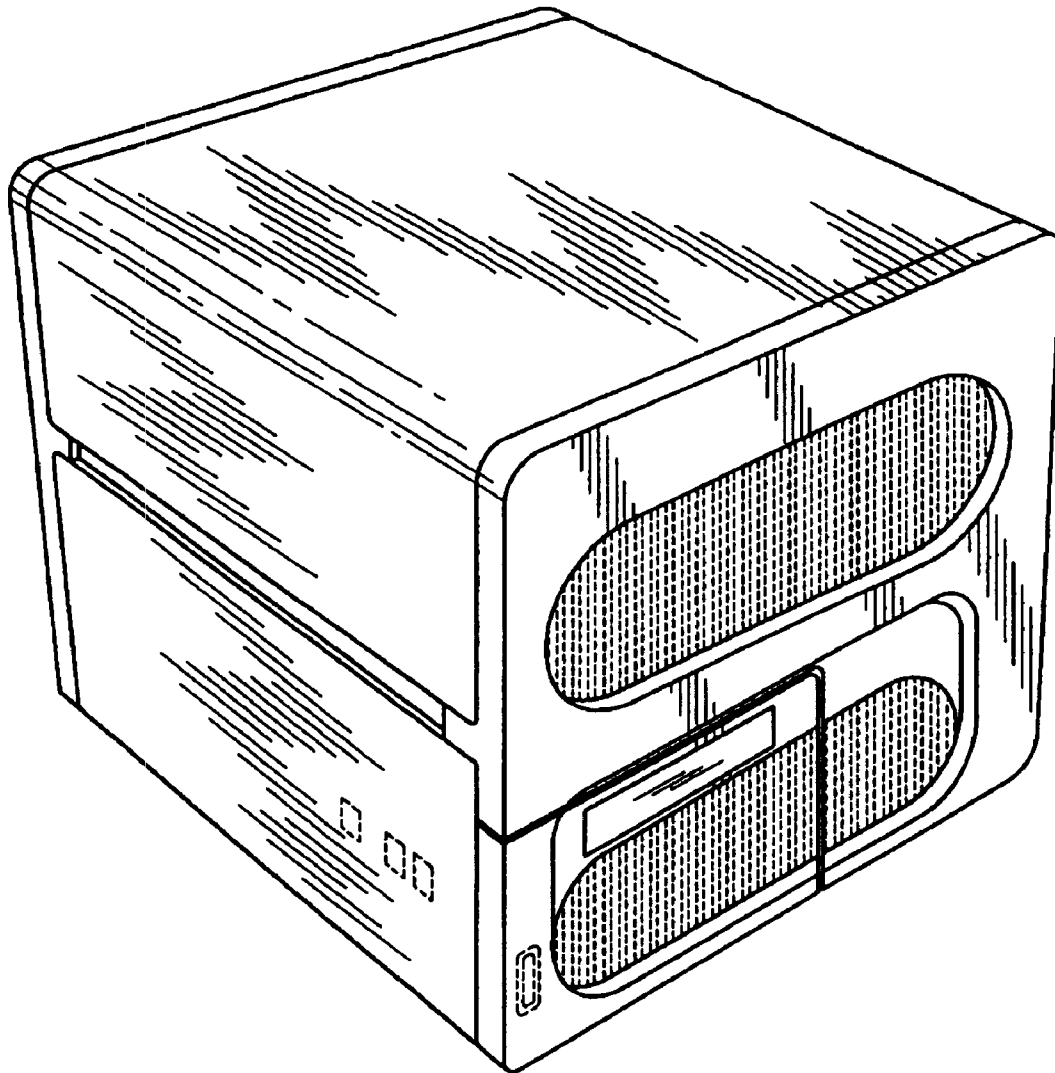

Fig. 1

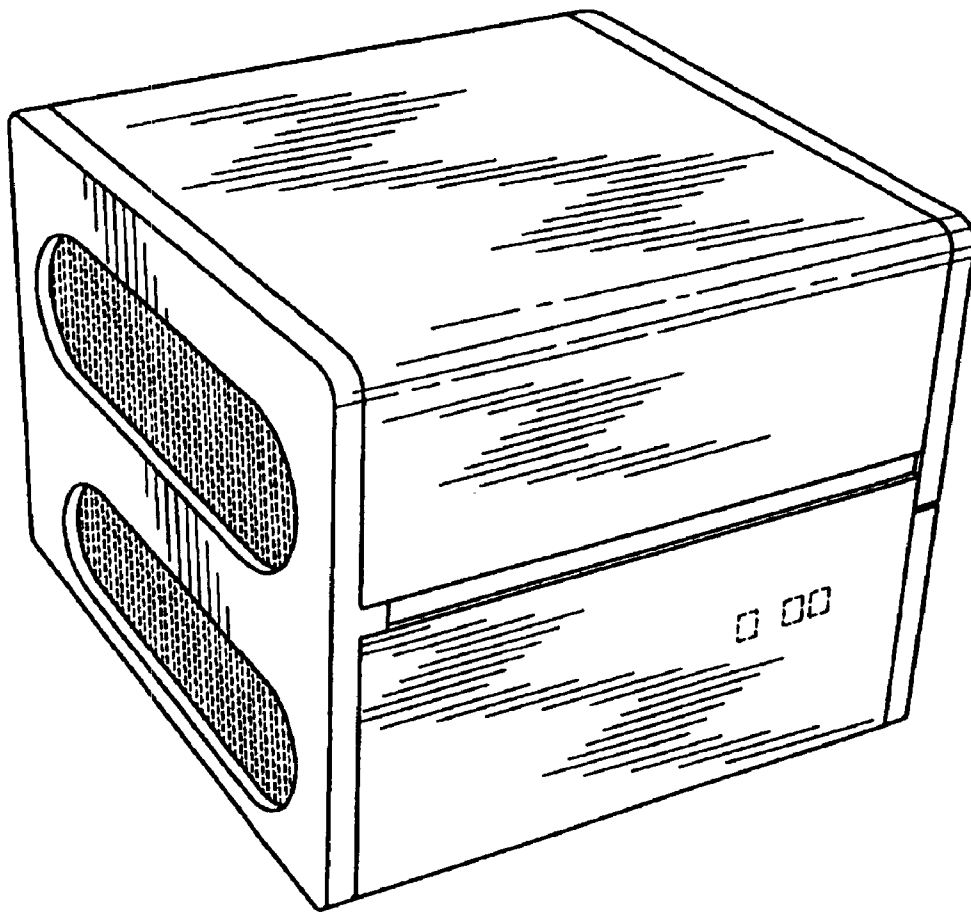

Fig. 2

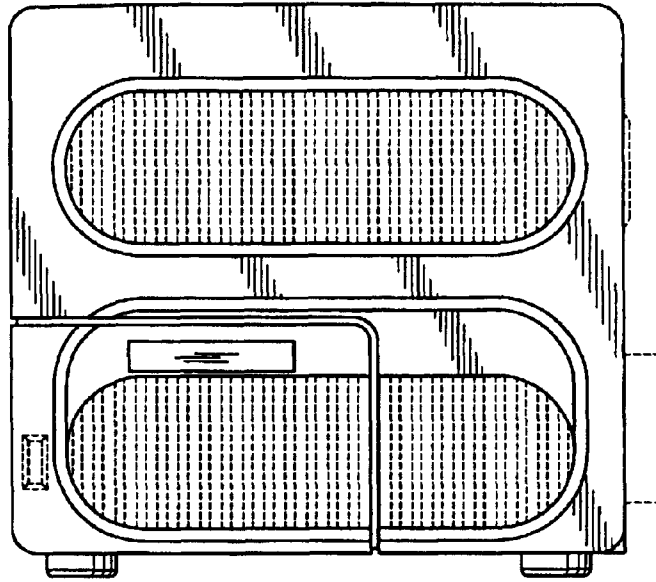

Fig. 3

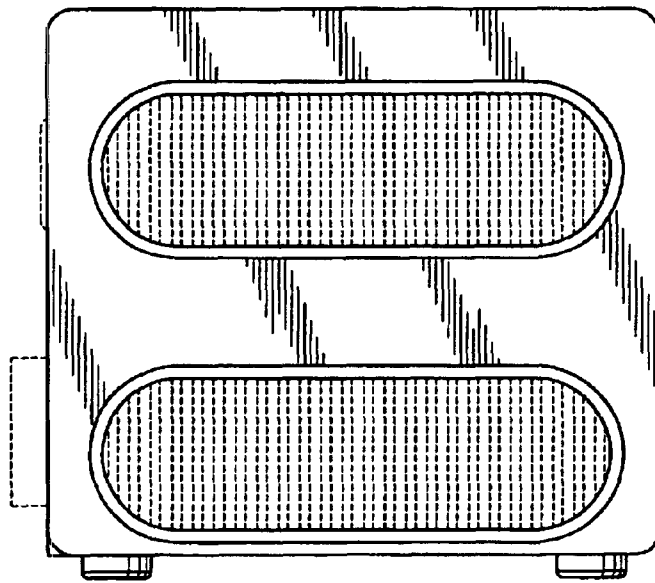

Fig. 4

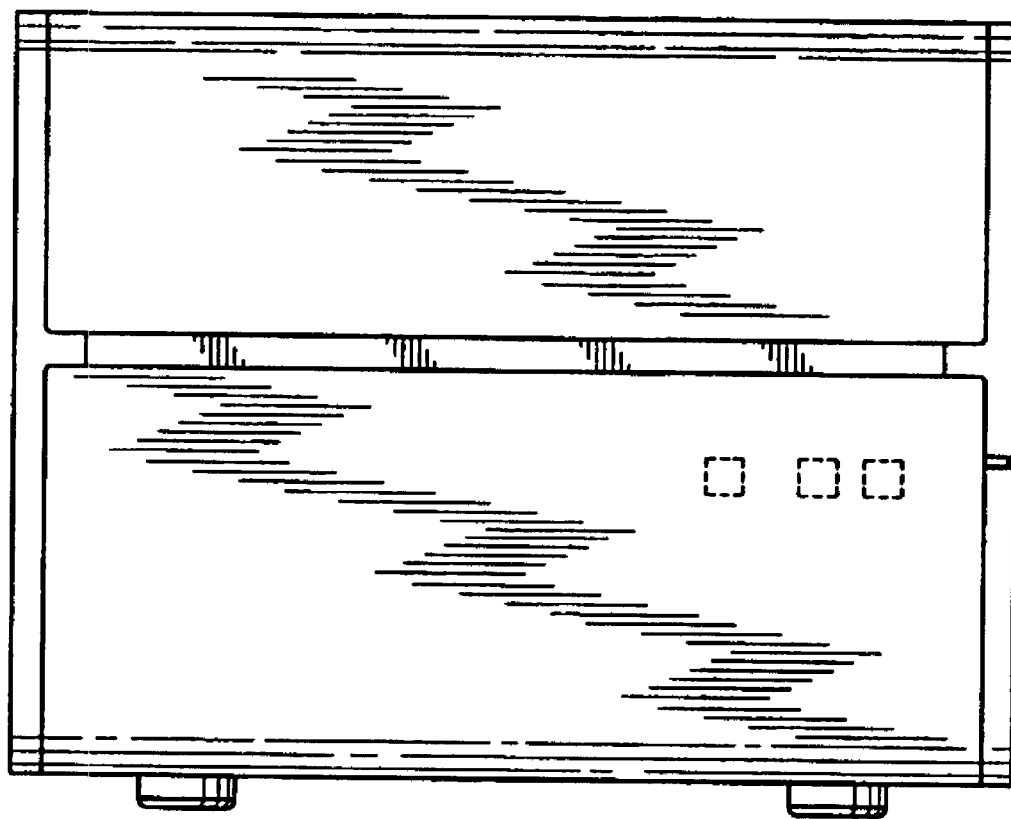

Fig. 5

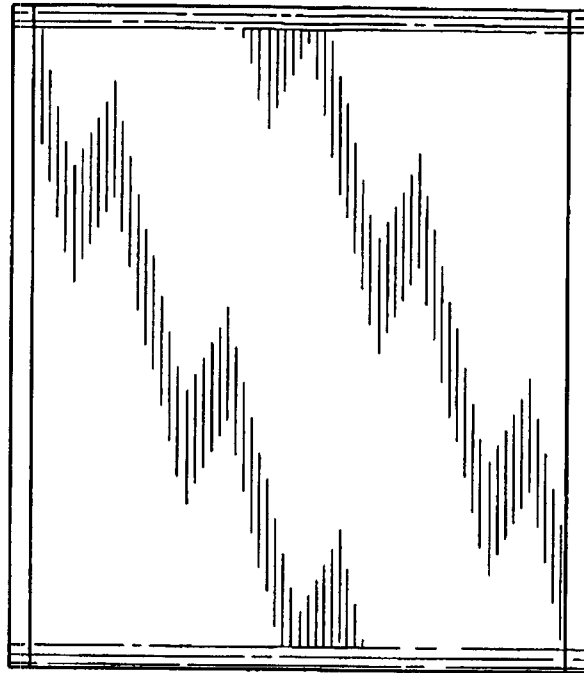

Fig. 6

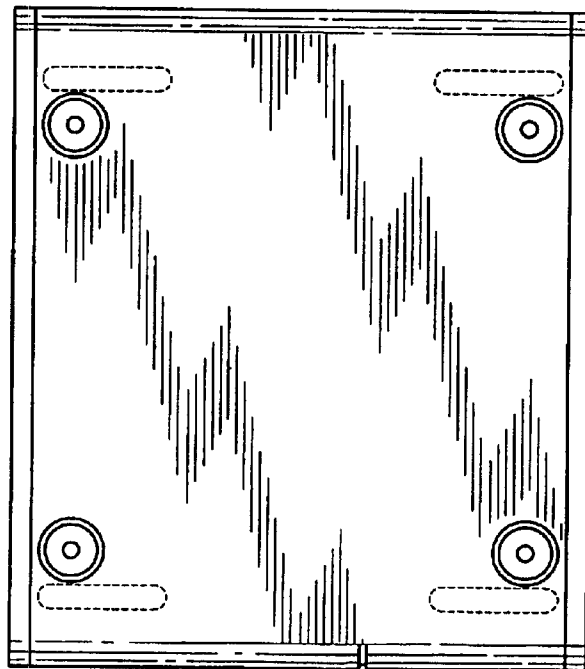

Fig. 7

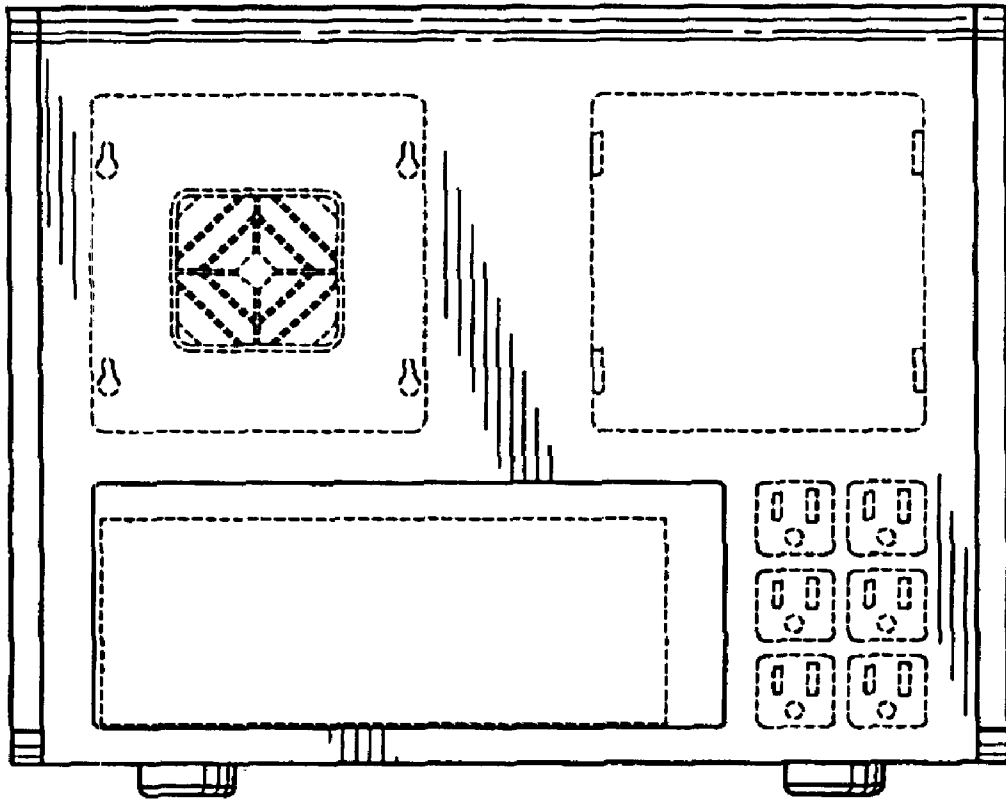

Fig. 8



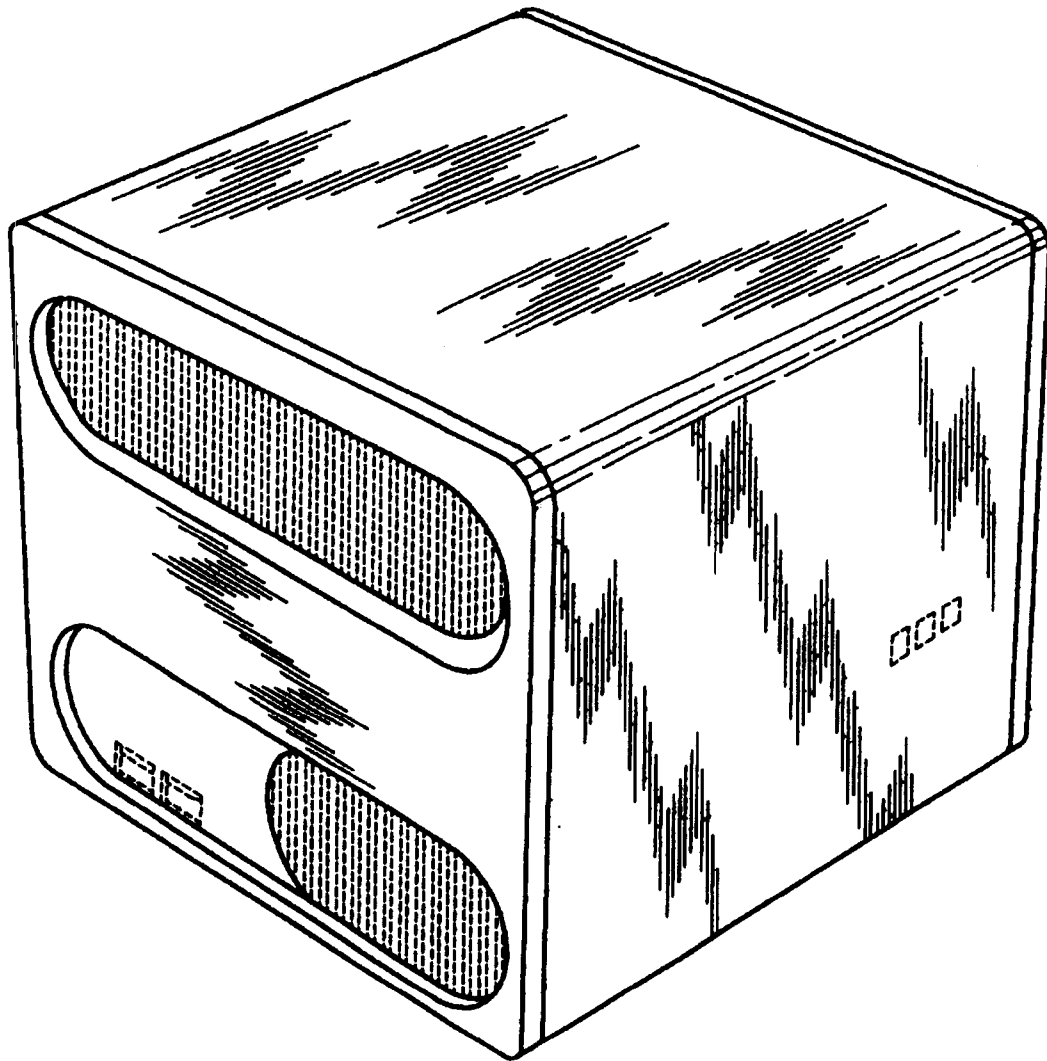

Fig. 9

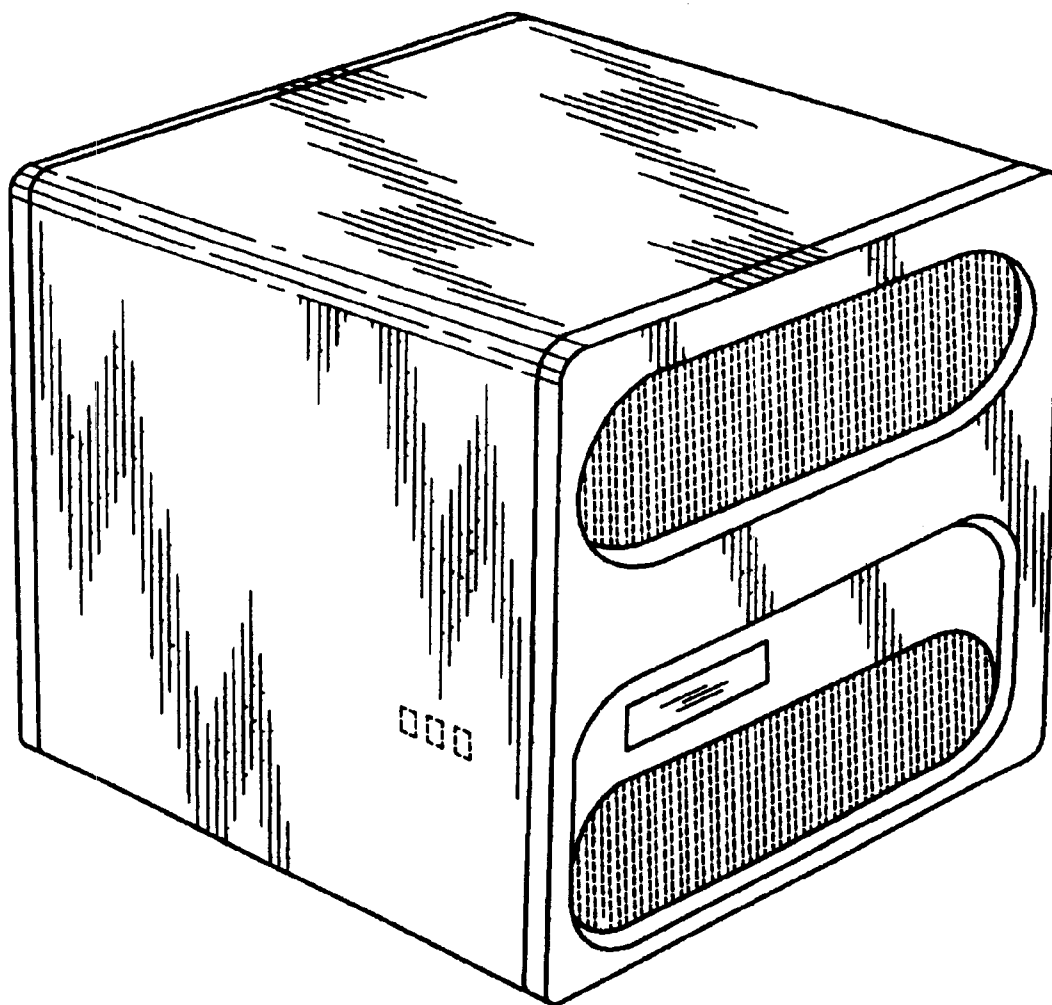

Fig. 10

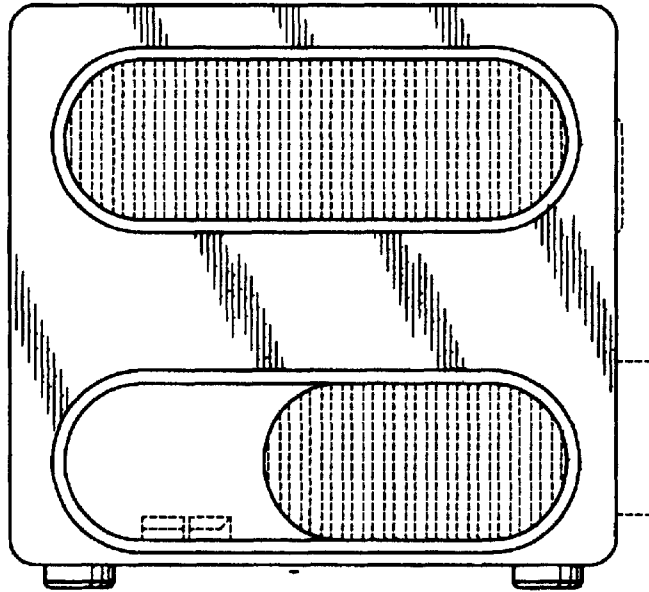

Fig. 11

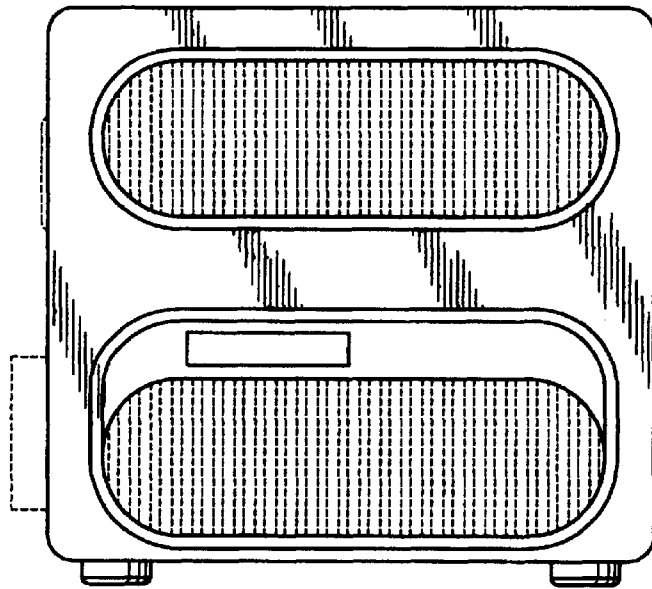

Fig. 12

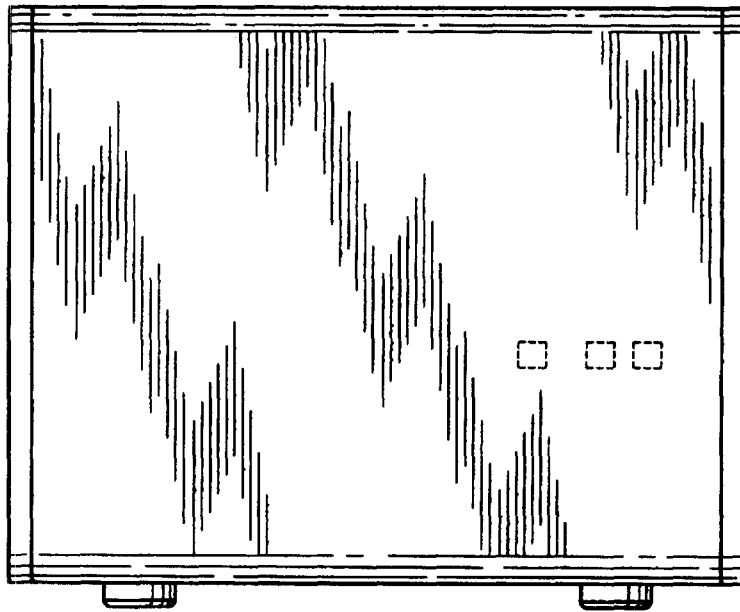

Fig. 13

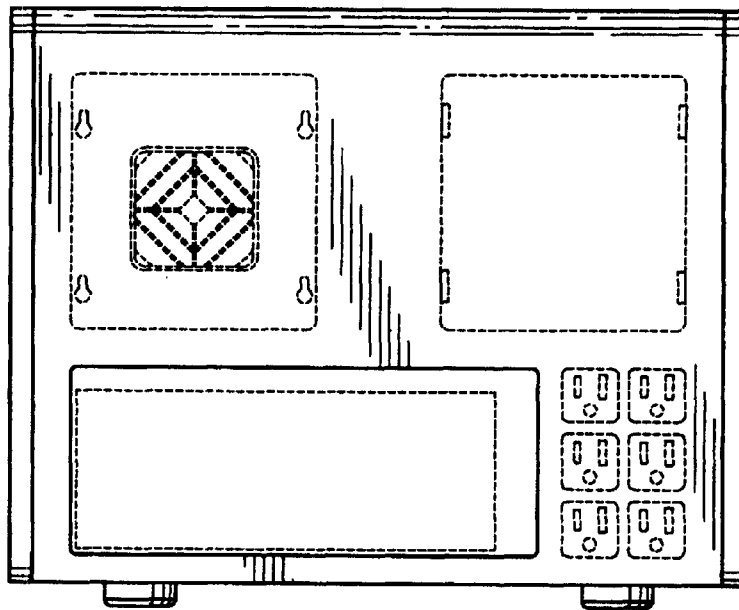

Fig. 14

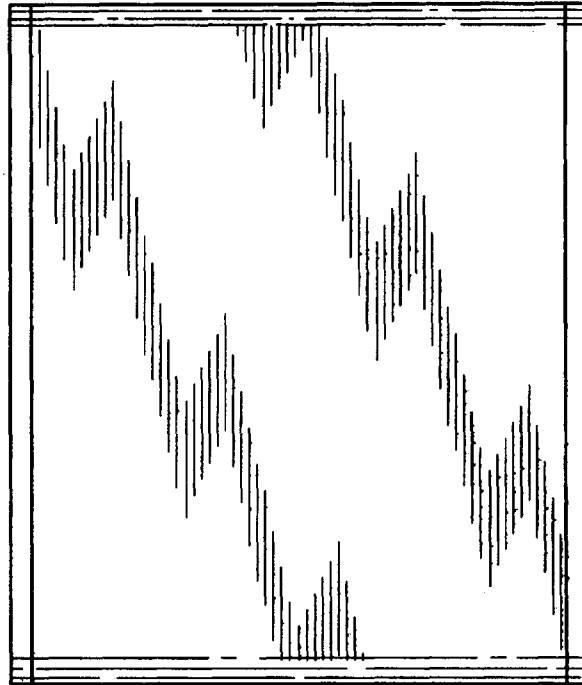

Fig. 15

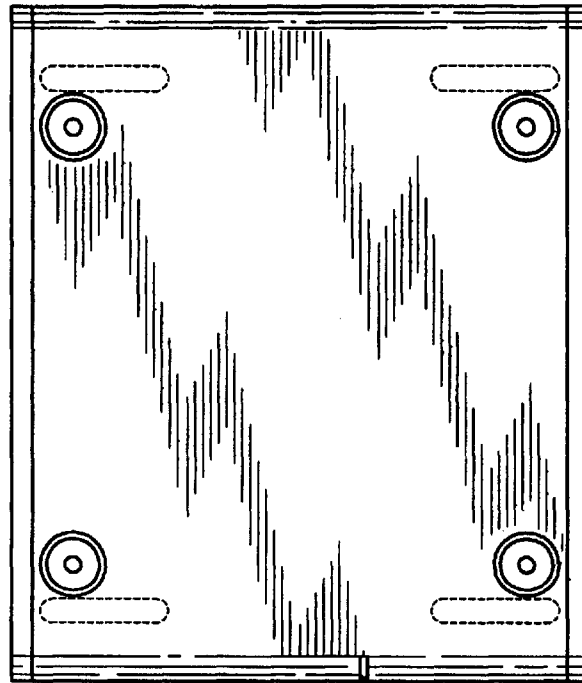

Fig. 16

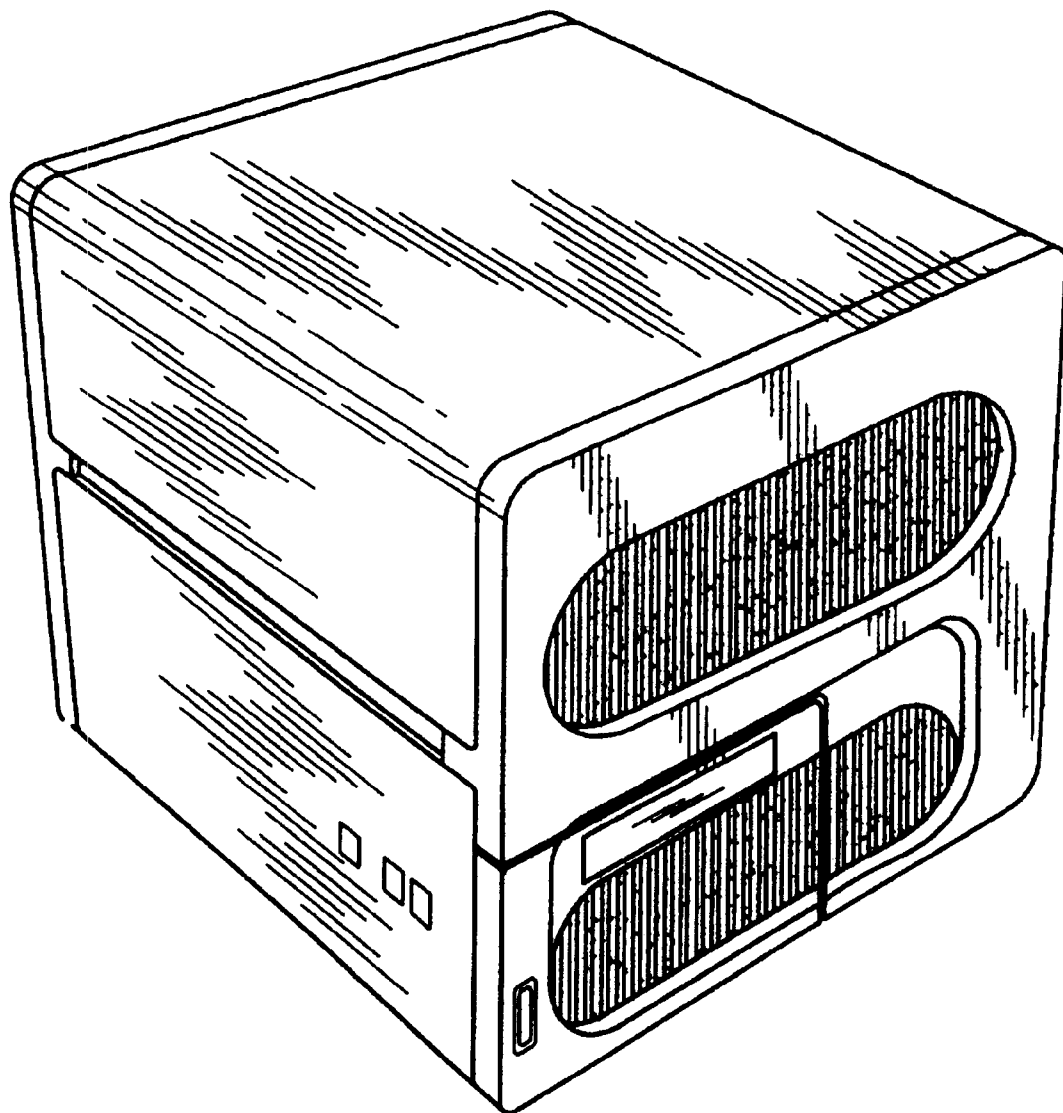
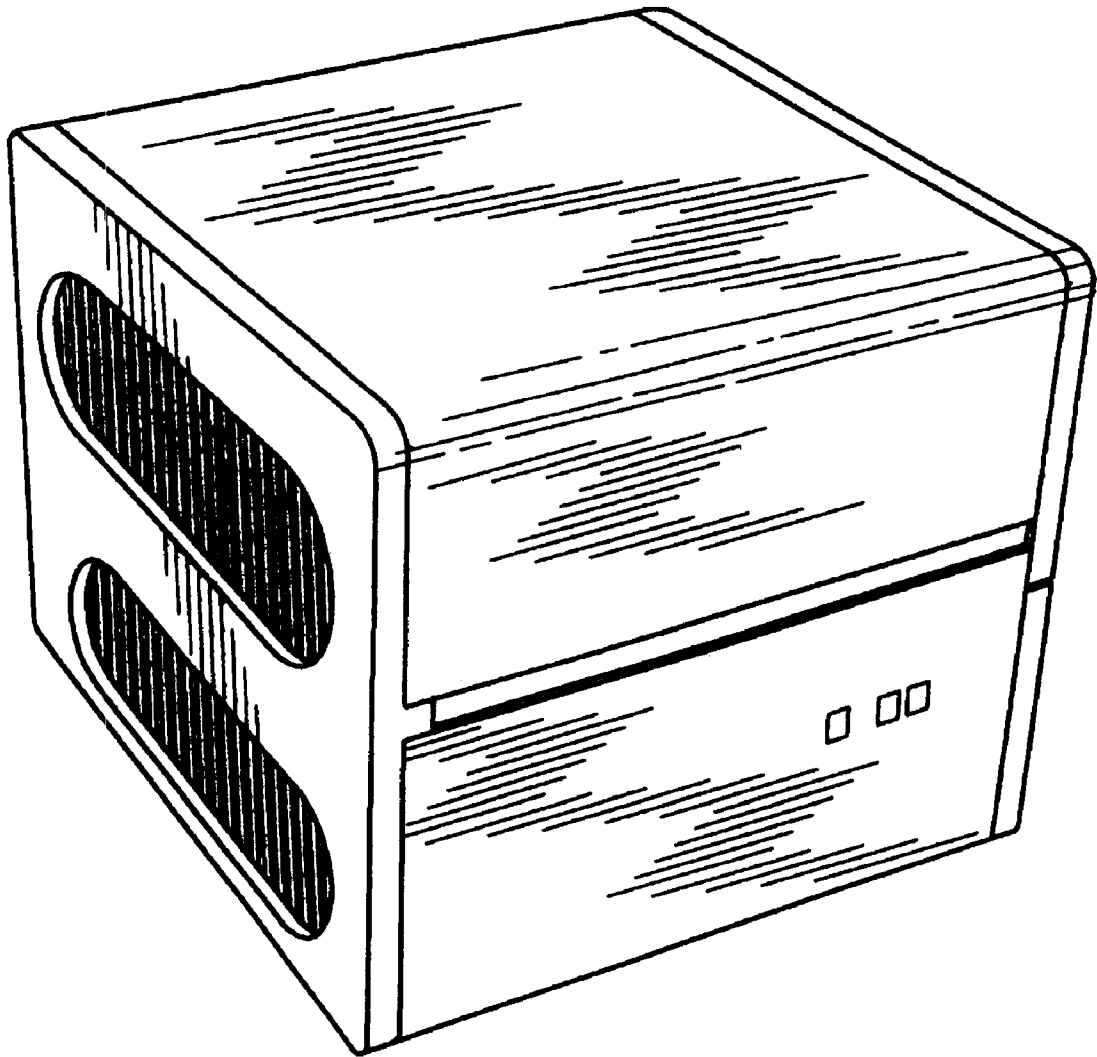

Fig. 17



**Fig. 18**

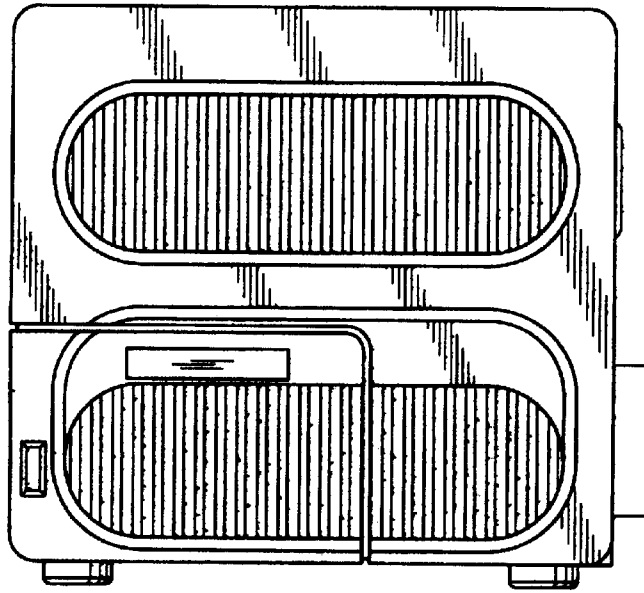

Fig. 19

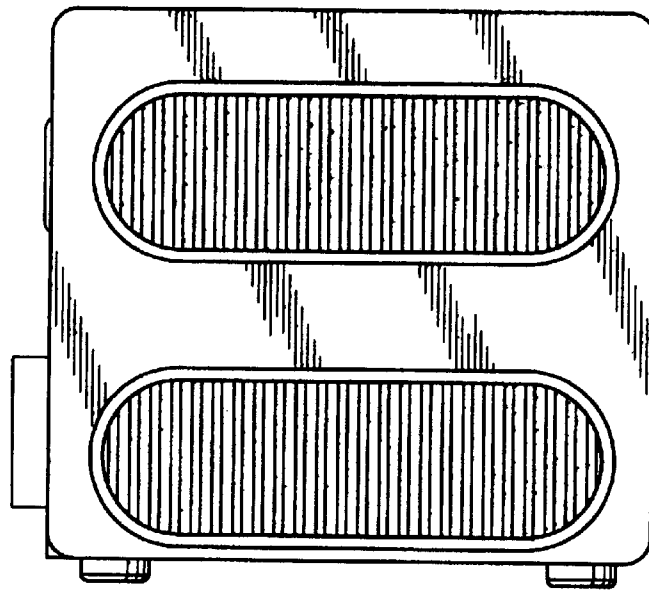

Fig. 20



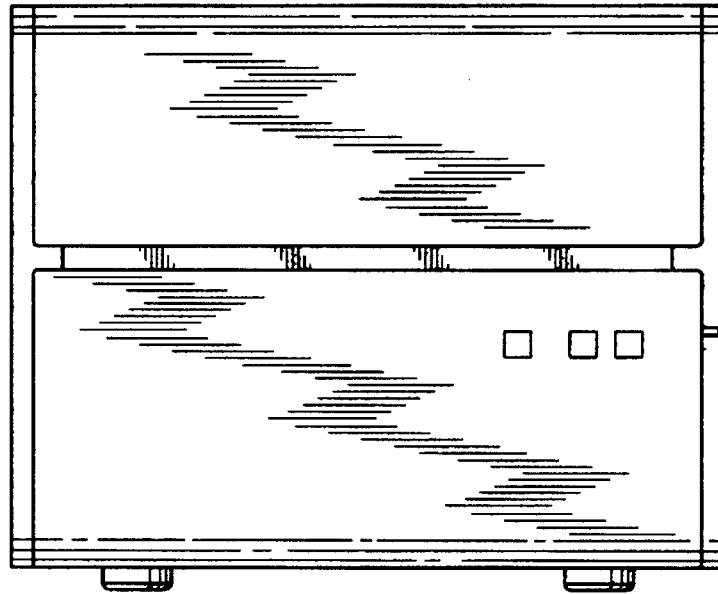

Fig. 21

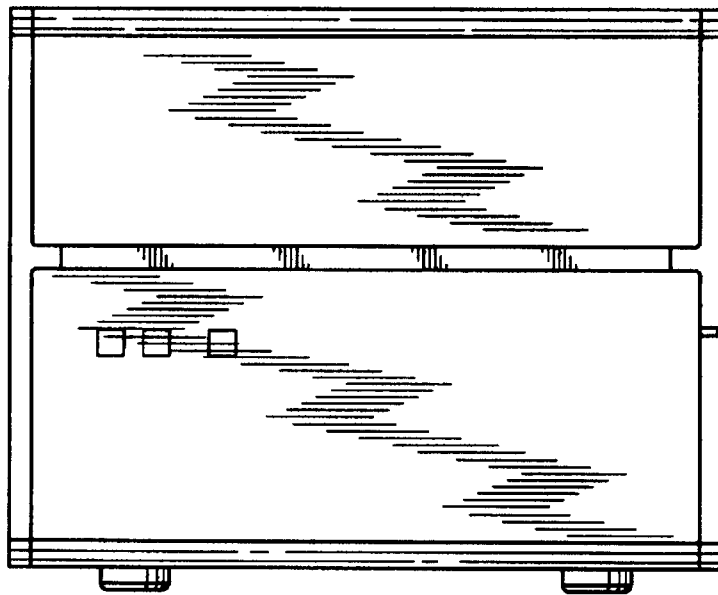

Fig. 22

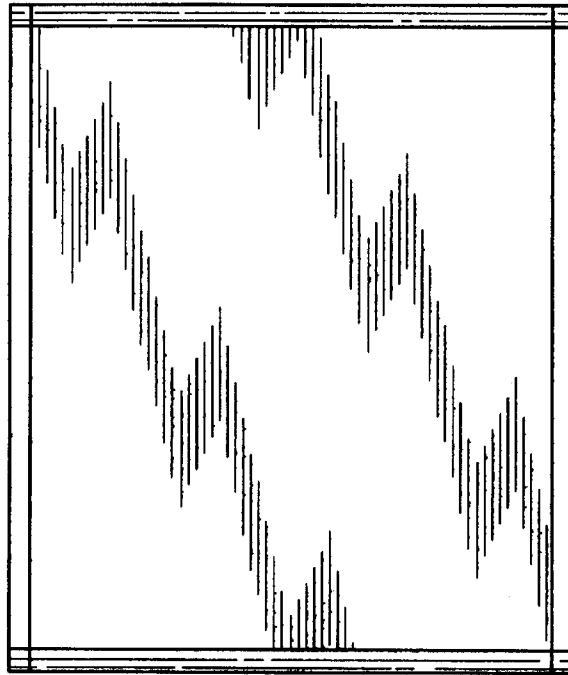

Fig. 23

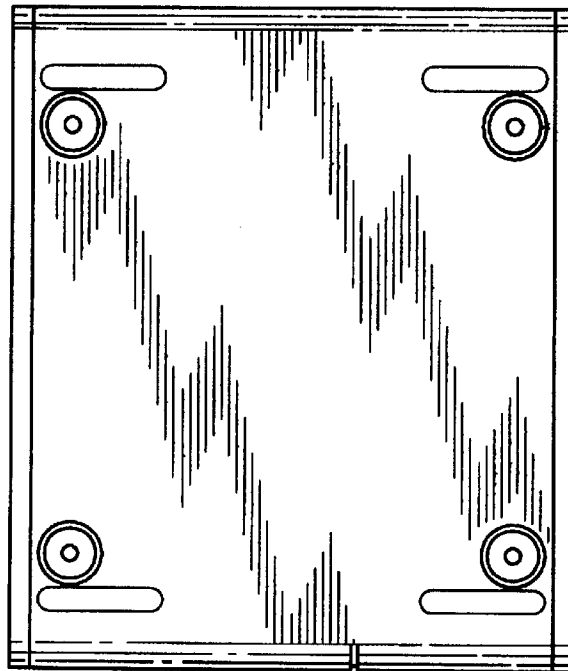

Fig. 24

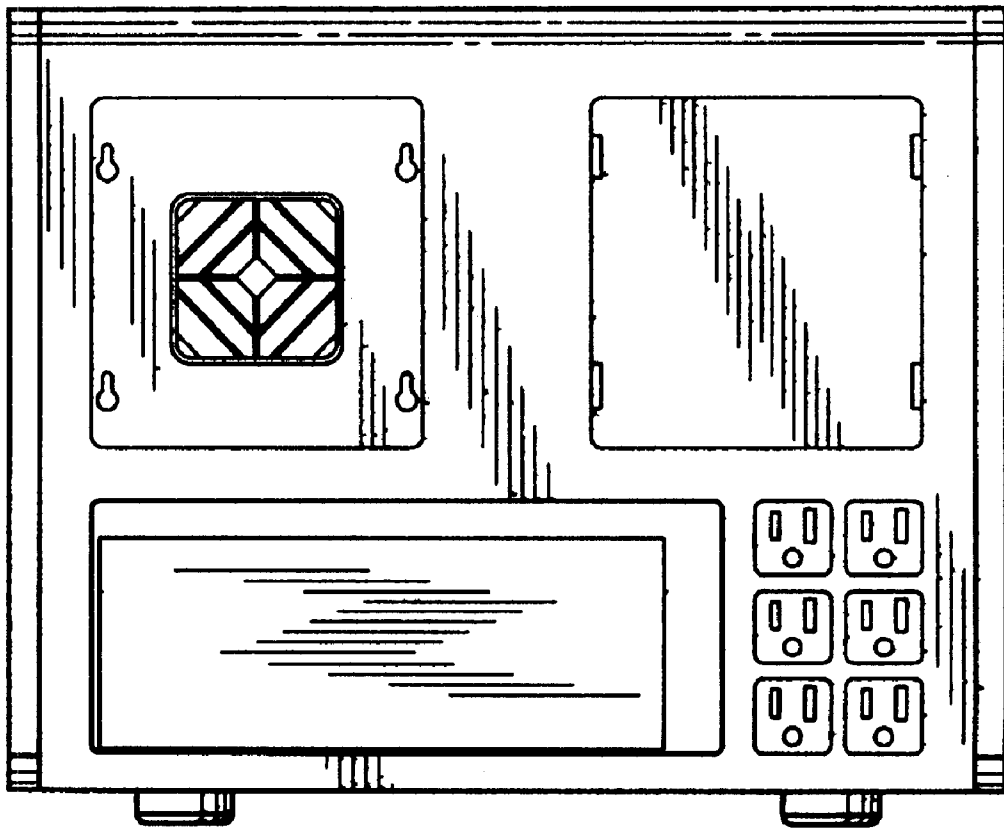

Fig. 25

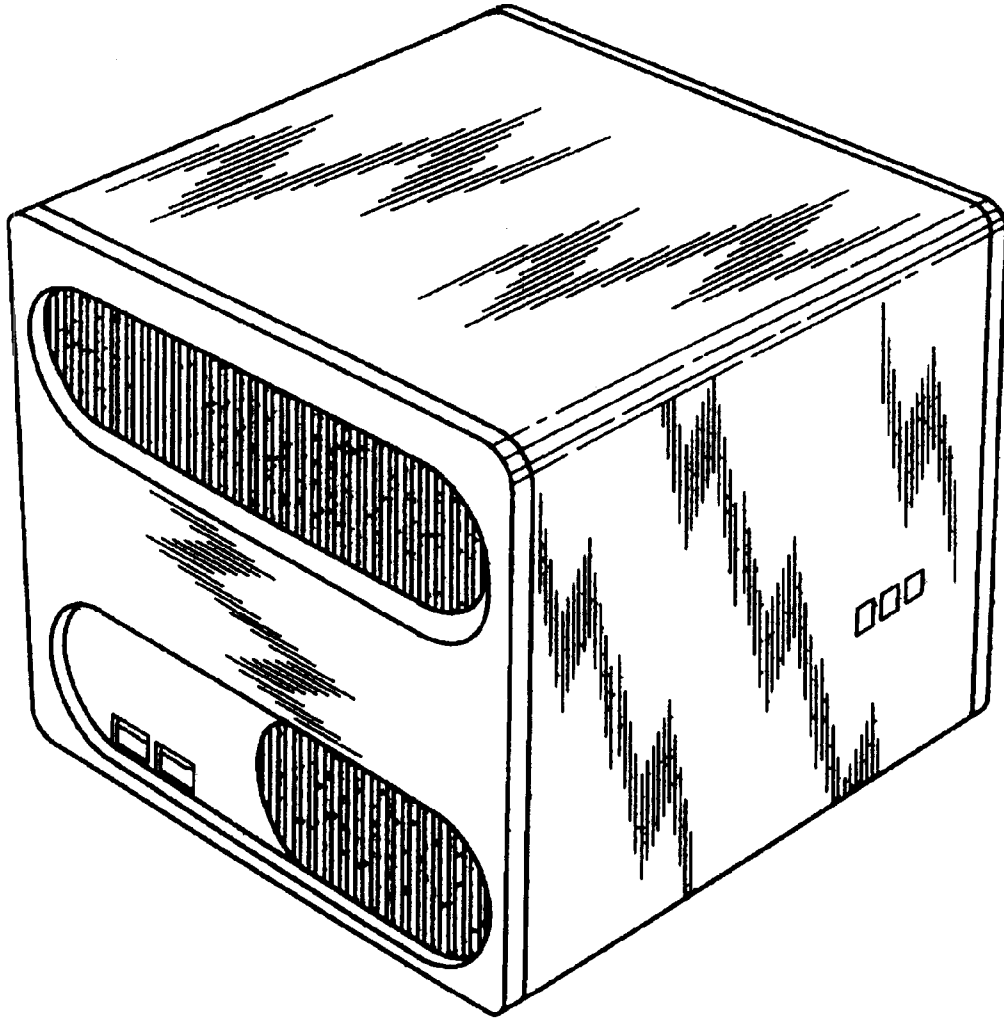

Fig. 26

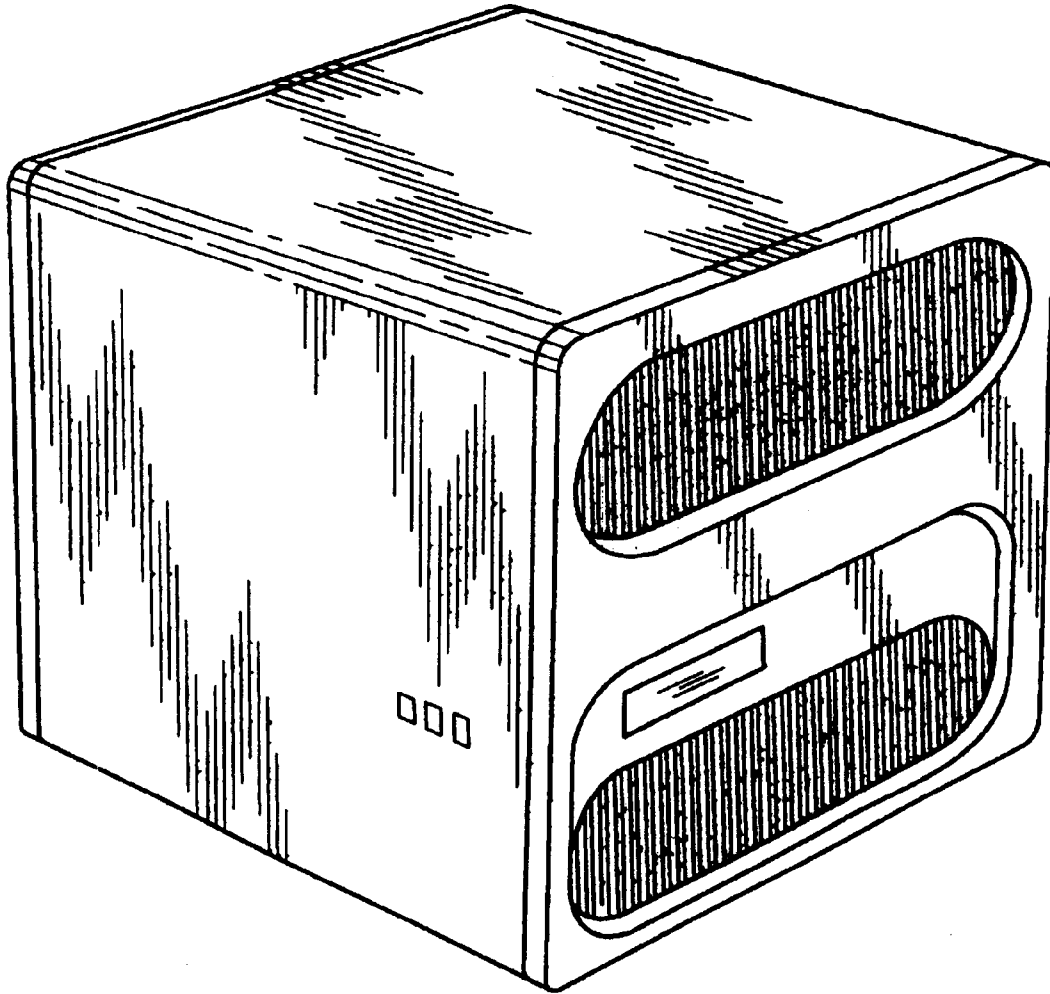

Fig. 27

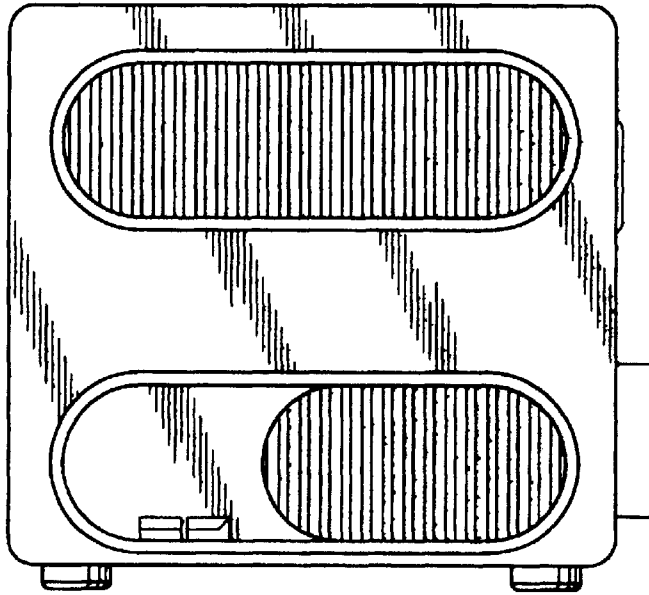

Fig. 28

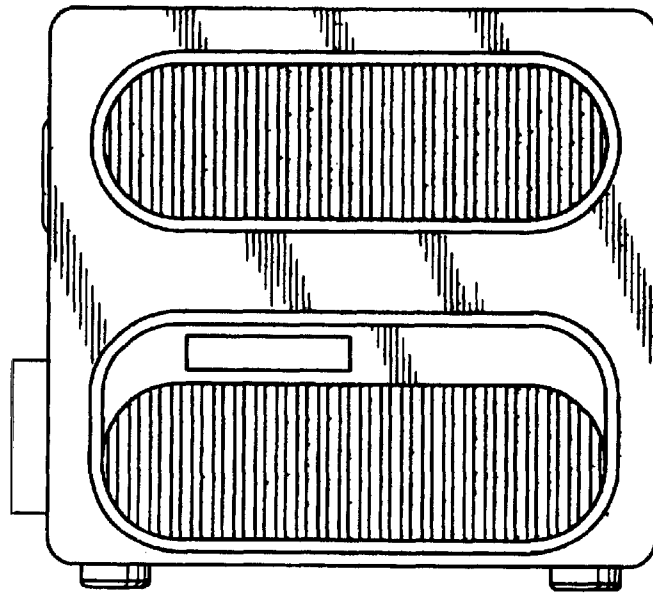

Fig. 29

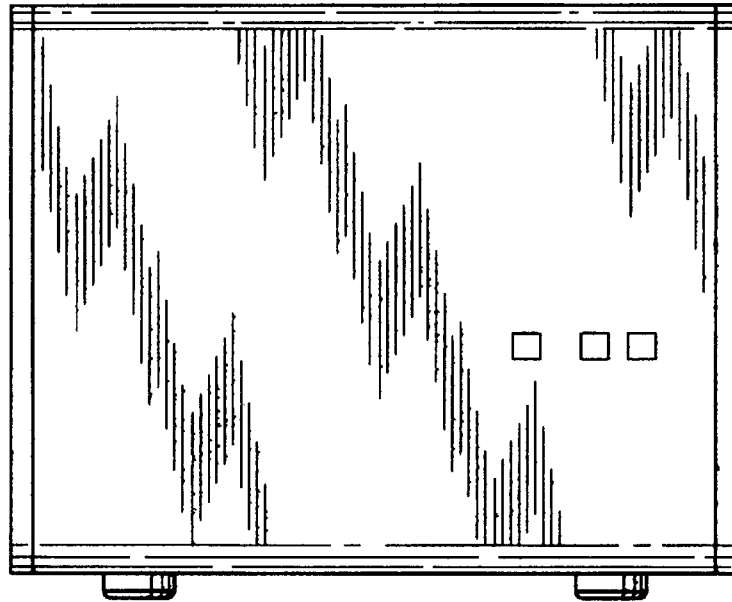

Fig. 30

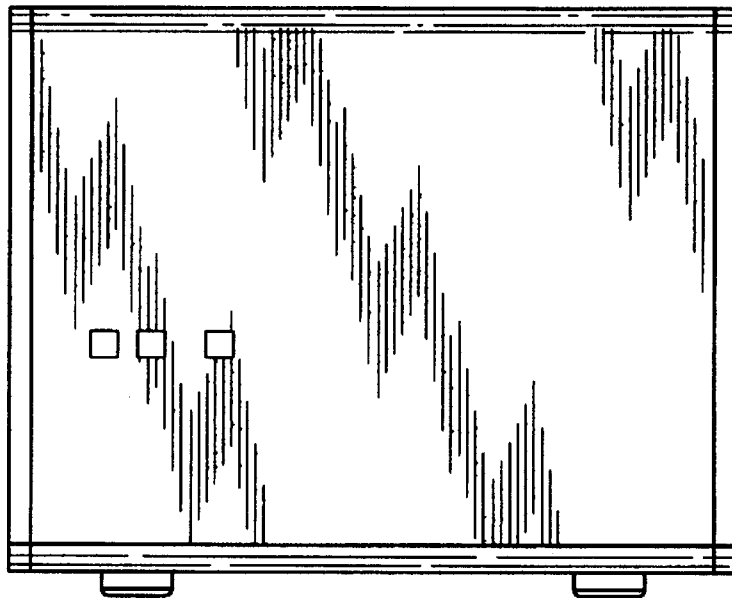

Fig. 31

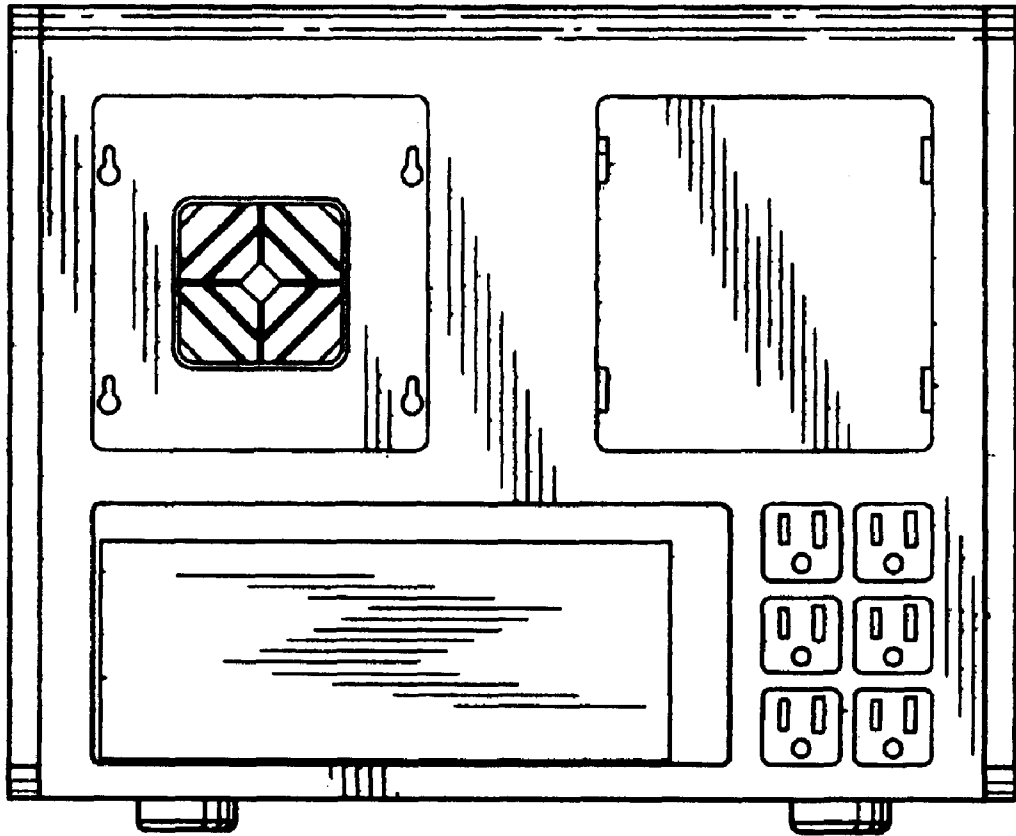
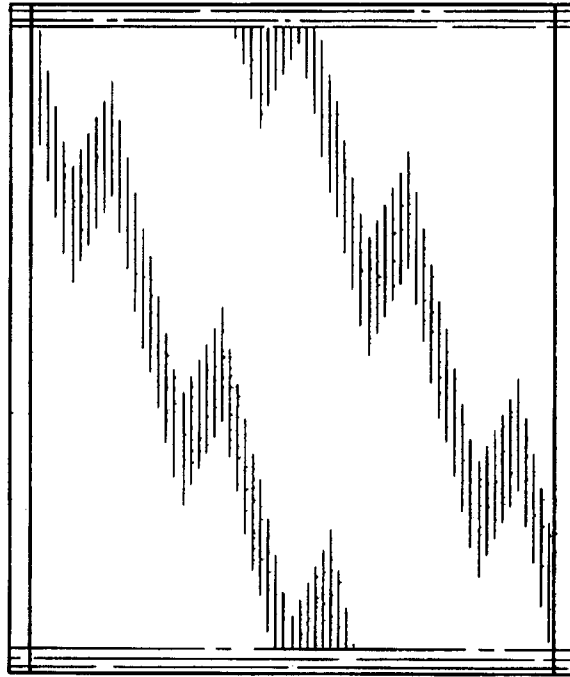
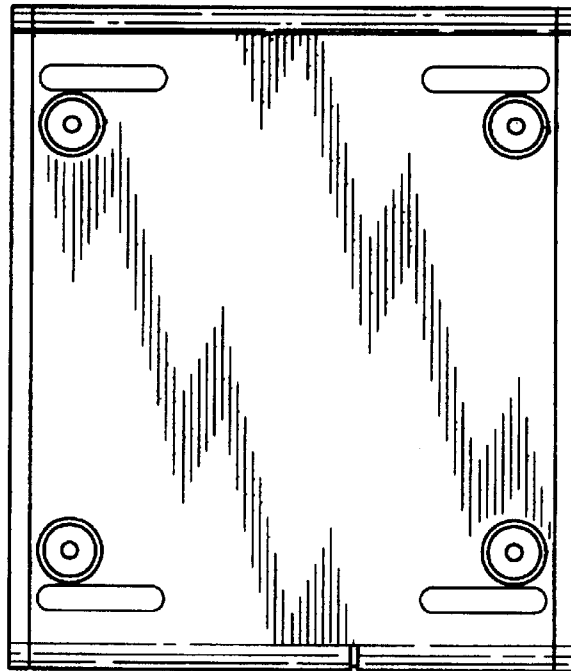

Fig. 32





**Fig. 33**



**Fig. 34**