

1 591 471

- (21) Application No. 25563/77
- (22) Filed 18 June 1977
- (23) Complete Specification filed 31 May 1978
- (44) Complete Specification published 24 June 1981
- (51) INT. CL.³ H01F 7/16
- (52) Index at acceptance
H1P 1B 2B 2E 2H 2J
- (72) Inventor FRANCIS GUY SYDENHAM ENGLISH



(54) IMPROVEMENTS IN AND RELATING TO
ELECTROMAGNETIC ACTUATORS

(71) I, JOHN CHARLES HUMPHREYS HART, a British subject, of Riverside Cottage, Trochry, near Dunkeld, Perthshire, (formerly of Waterfield, Baslow Road, Bakewell, Derbyshire), do hereby declare the invention for which I pray that a patent may be granted to me, and the method by which it is to be performed, to be described in and by the following statement:—

The invention relates to electromagnetic actuators and to valves incorporating such actuators.

According to the invention a bistable actuator comprises a magnetic member moveably mounted in a housing of magnetic material, for axial movement between two positions, in each of which such member is positively located adjacent a respective permanent magnet, pole piece means centrally located between the permanent magnets and extending radially inwardly from said housing to within a slot formed in the moveably mounted member and a separate coil located within the housing between the pole piece means and each permanent magnet for energisation to at least counteract the magnetic flux produced by the adjacent permanent magnet and allow movement of said member from one of its positions to the other.

The actuator may be generally cylindrical and the permanent magnets may each comprise an axially magnetised ring magnet preferably formed by a samarium cobalt. Each ring magnet may be located on a backing member of magnetic material which abuts the housing.

The permanent magnets may be arranged to have like poles facing towards the moveably mounted member, with both coils arranged to be energised in series or parallel to cause movement of the moveably mounted member.

Alternatively the permanent magnets may be arranged to have unlike poles facing towards the moveably mounted member with the coil adjacent the permanent magnet which is locating said member being energised to cause movement of said member from one of its positions to the other.

Buffer means may be located on the moveably mounted member or on the pole piece means to ensure that such member is retained spaced from the permanent magnets.

The moveably mounted magnetic member may comprise or incorporate the flow control member of a fluid control valve.

A pair of fluid passages may enter the housing adjacent each permanent magnet, one such pair being closed by the moveably mounted member and the other pair being open to the interior of the housing for one position of the moveably mounted member and *vice versa* for the other such position of the moveably mounted member.

The moveably mounted member may comprise or include the spool of a spool and sleeve valve, the sleeve thereof comprising or including said pole piece means.

The moveably mounted member may comprise the control member of a poppet valve with the pole piece means including inlet/outlet ports of the valve.

The foregoing and further features of the invention may be more readily understood from the following description of some preferred embodiments thereof by way of example, with reference to the accompanying drawings, in which:—

Fig. 1 is a side sectional view of a bistable actuator;

Fig. 2 is a side sectional view of a bistable pilot valve;

Fig. 3 is a side sectional view of a spool and sleeve valve;

Fig. 4 is a side sectional view of a poppet valve;

Fig. 5 shows part end sectional views at lines A and B respectively of Fig. 4;

Fig. 6 is a side sectional view of an alternative bistable pilot valve;

Fig. 7 is a side sectional view of an alternative spool and sleeve valve, and

Fig. 8 is a schematic representation of an actuator including return springs.

Referring firstly to Fig. 1 there is shown a bistable actuator comprising a cylindrical housing 10 of magnetic material with end closure members 11 of magnetic material 100

55

65

70

75

80

85

90

95

100

housing bearings 12 mounting a shaft 13 of non-magnetic material for longitudinal movement.

5 Axially magnetised ring magnets 14 and 15 of samarium cobalt are attached to respective backing members 16 and 17 of magnetic material which are located one abutting each end closure member 11.

10 A member of magnetic material or armature 18 is located on shaft 13 for movement between magnets 14 and 15. The armature 18 is formed with an annular slot 19 extending therealong and a pole piece 20 in the form of an apertured disc of magnetic material extends from housing 10 to within slot 19 with a minimum clearance therebetween. A resilient buffer ring 21 is located in slot 19 at each end thereof but these could alternatively be carried on pole piece 20. The buffer rings 21 ensure that the armature 18 does not engage the magnets 14 and 15 during operation.

25 A coil A is located between one member 11 and pole piece 20 to surround member 16, magnet 14 and part of armature 18. Similarly a coil B is located between the other end member 11 and pole piece 20 to surround member 17, magnet 15 and part of armature 18.

30 In this embodiment the permanent magnets 14 and 15 are arranged with like poles facing the armature 18. In use the armature 18 is retained in position adjacent magnet 14, as shown in Fig. 1, without the need for any energisation of coils A or B. When it is required to move armature 18 to its other position adjacent magnet 15, coils A and B are pulse energised in series or parallel so as to produce magnetic flux to oppose the permanent magnet flux of magnet 14 and to aid the flux of magnet 15. The armature then moves to the other position adjacent magnet 15 where it is retained until coils A and B are pulse energised with opposite polarity to return armature 18 to the position adjacent magnet 14. The shaft 13 is attached to a switch, valve or other device to be actuated by such actuator.

50 Referring now to Fig. 2 there is shown a similar device to that of Fig. 1 but in the form of a pilot valve. In this device shaft 13 is omitted and armature 18' is guided within cylindrical brass guides 22 extending between members 16' and 17' to pole piece 20.

55 Members 16' and 17' are formed with passages 23 leading to respective ports 24. The armature 18' carries buffer and sealing members 25 to buffer the action of the device and seal the passages 23 of whichever member 16' or 17' it is adjacent.

65 In this embodiment the magnets 14 and 15 are arranged with unlike poles facing armature 18. In operation, to move armature 18 from the position shown in Fig. 2

to abut member 17', the coil A is pulse energised so as to produce a magnetic flux to oppose the magnetic flux of magnet 14. The armature 18 then moves due to attraction of the magnetic flux of magnet 15. The armature 18 will remain in this position until coil B is energised to return armature 18 to the position shown in Fig. 2.

70 The Fig. 1 embodiment could be arranged to operate in the manner of Fig. 2 and *vice versa*.

75 Referring now to Fig. 3 there is shown a spool and sleeve valve which can be actuated in the manner described with reference to Fig. 1 or Fig. 2.

80 In this embodiment member 18'' includes a spool 30 having lands 31 which control fluid flow between passages 32, 33 and 34 formed in pole piece 20'. Member 18'' also carries an 'O' ring 35 at each end thereof for sealingly engaging with respective ports 36 and 37 of passages 38 and 39 formed in the housing to pass within respective magnets 14 and 15. With the member 18'' in the position shown in the drawing fluid enters via passage 32 and exits via passage 33 whilst further fluid enters via passage 34 and exits via armature port 118 and passage 39, port 36 of passage 38 being closed by adjacent 'O' ring 35. In the other position of member 18'' fluid entering passage 32 exits via passage 34, with port 37 of passage 39 closed, and fluid flow entering passage 33 exits via passage 38 via armature ports 118a.

100 Referring to Figs. 4 and 5 there is shown a poppet valve which again can operate in either the manner of Fig. 1 or Fig. 2.

105 This valve is operated to provide the various fluid flows between passages 32', 33', 34', 38' and 39' as described for the Fig. 3 embodiment. However in this embodiment the spool is replaced by respective 'O' rings 40 carried on member 18a which close either port 41 or port 42 respectively connecting port 32' with port 33' and 34' and contained in pole piece 20''. In this embodiment there is also shown a distribution member 43 for providing external connections to the fluid flow passages.

115 Referring now to Fig. 6 there is shown an alternative form of pilot valve which can again operate in either the manner of Fig. 1 or Fig. 2.

120 In this embodiment there are two ports A'' and B'' adjacent magnet 14 and a single port C'' adjacent magnet 15.

This valve can be connected to operate to give three different fluid flows:

(a) Port A'' connected to pressure line. When the armature 18c is energised to move to the right, pressure is supplied to port B'' via the four slots in the lining of the end cap and the annular recess R'' as illustrated by the arrows. When the armature

70

75

80

85

90

95

100

105

110

115

120

125

130

18c is energised to move to the left then port A" is closed and the supply port B" is open to exhaust through port C".

5 (b) Port C" connected to the pressure line. When the armature 18c moves to the left port B" is open to port C" as illustrated by the dashed arrows and port A" is closed. When the armature 18c returns to the right the port A" acts as the exhaust.

10 (c) Port B" connected to the pressure line. With the armature 18c to the right there is a direct flow to port A".

Referring now to Fig. 7 there is shown an alternative form of spool and sleeve valve which again can operate in either the manner of Fig. 1 or Fig. 2.

In this embodiment fluid flow is directed between pairs of the five ports 70 of sleeve 20' under control of the three lands 71 on spool 18" in known manner.

Referring now to Fig. 8 there is shown schematically an actuator similar to that of Fig. 1 except that springs 80 and 81 are included to act on shaft 13. The arrangement is such that the magnetic flux produced by magnet 14 and coil A is greater than the force of springs 80 and the magnetic flux produced by magnet 15 and coil B is greater than the force of spring 81. When the current is reversed in coil A or B the armature is urged towards the central position by spring 80 or 81 respectively. Such an arrangement could be used with any of the previously described embodiments.

WHAT I CLAIM IS:—

1. A bistable actuator comprising a magnetic member moveably mounted, in a housing of magnetic material, for axial movement between two positions, in each of which such member is positively located adjacent a respective permanent magnet, pole piece means centrally located between the permanent magnets and extending radially inwardly from said housing to within a slot formed in the moveably mounted member and a separate coil located within the housing between the pole piece means and each permanent magnet for energisation to at least counteract the magnetic flux produced by the adjacent permanent magnet and allow movement of said member from one of its positions to the other.

2. A bistable actuator as claimed in claim 1 wherein the actuator is generally cylindrical and the permanent magnets each comprise an axially magnetised ring magnet.

3. A bistable actuator as claimed in claim 2 wherein each ring magnet is located on a backing member of magnetic material which abuts the housing.

4. A bistable actuator as claimed in any preceding claim wherein each permanent magnet is formed of samarium cobalt.

5. A bistable actuator as claimed in any preceding claim wherein the permanent magnets are arranged to have like poles facing towards the moveably mounted member, with both coils arranged to be energised in series or parallel to cause movement of the moveably mounted member.

6. A bistable actuator as claimed in any of claims 1 to 4 inclusive wherein the permanent magnets are arranged to have unlike poles facing towards the moveably mounted member with the coil adjacent the permanent magnet which is locating said member being energised to cause movement of said member from one of its positions to the other.

7. A bistable actuator as claimed in any preceding claim wherein buffer means is located on the moveably mounted member or on the pole piece means to ensure that such member is retained spaced from the permanent magnets.

8. A bistable actuator as claimed in any preceding claim wherein the moveably mounted member comprises or incorporates the flow control member of a fluid control valve.

9. A bistable actuator as claimed in claim 8 wherein a pair of fluid passages enter the housing adjacent each permanent magnet, one such pair being closed by the moveably mounted member and the other pair being open to the interior of the housing for one position of the moveably mounted member and *vice versa* for the other such position of the moveably mounted member.

10. A bistable actuator as claimed in any one of claims 1 to 8 inclusive wherein the moveably mounted member comprises or includes the spool of a spool and sleeve valve, the sleeve thereof comprising or including said pole piece means.

11. A bistable actuator as claimed in claim 10 wherein a pair of fluid passages enter the housing adjacent one of the permanent magnets and a single fluid passage enters the housing adjacent the other permanent magnet.

12. A bistable actuator as claimed in claim 10 wherein said sleeve includes five fluid inlet/outlet ports and said spool is formed with three lands.

13. A bistable actuator as claimed in any one of claims 1 to 12 inclusive wherein a spring is arranged to cooperate with the moveably mounted member in at least one of its positively located positions.

14. A bistable actuator as claimed in claim 8 wherein the moveably mounted member comprises the control member of a poppet valve with the pole piece means including inlet/outlet ports of the valve.

15. A bistable actuator substantially as hereinbefore described with reference to

Fig. 1 of the accompanying drawing.

16. A bistable actuator substantially as hereinbefore described with reference to Fig. 2 of the accompanying drawing.

5 17. A bistable actuator substantially as hereinbefore described with reference to Fig. 3 of the accompanying drawing.

10 18. A bistable actuator substantially as hereinbefore described with reference to Figs. 4 and 5 of the accompanying drawing.

19. A bistable actuator substantially as hereinbefore described with reference to Fig. 6 of the accompanying drawing.

20. A bistable actuator substantially as hereinbefore described with reference to Fig. 7 of the accompanying drawing.

21. A bistable actuator as claimed in any one of claims 15 to 20 inclusive modified substantially as hereinbefore described with reference to Fig. 8 of the accompanying drawings.

For the Applicant:
SORRELL & SON,
Chartered Patent Agents,
Otham, Maidstone,
Kent, ME15 8RR.

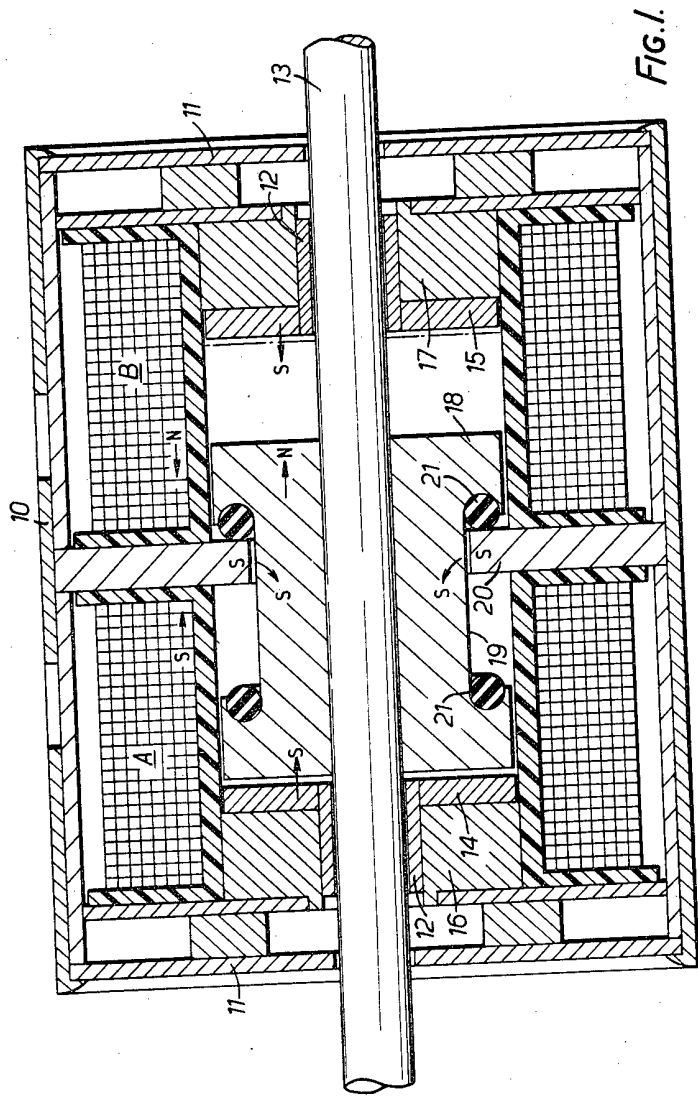

FIG. 1.

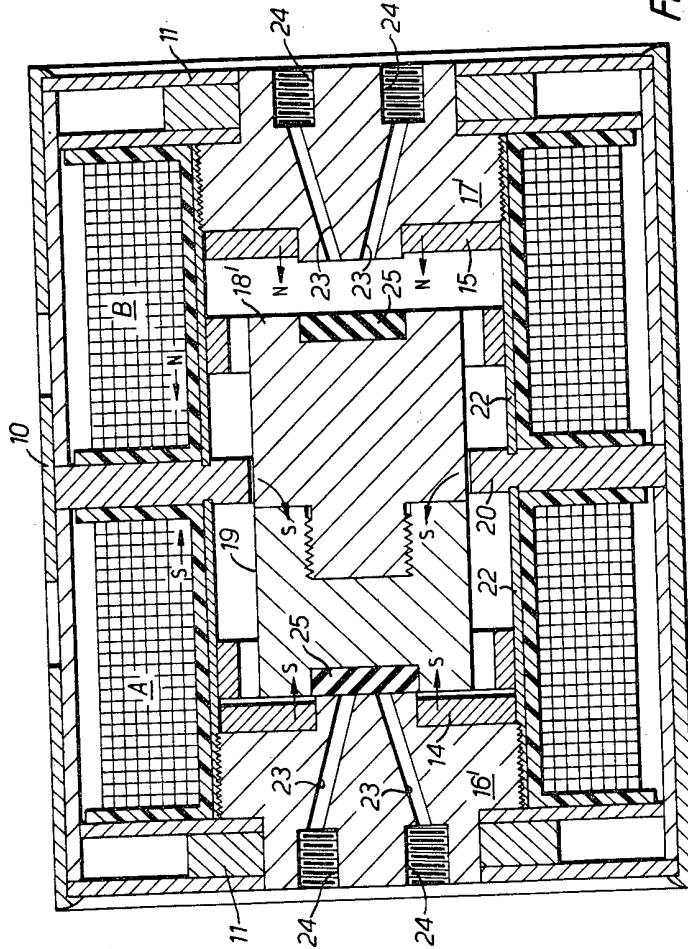
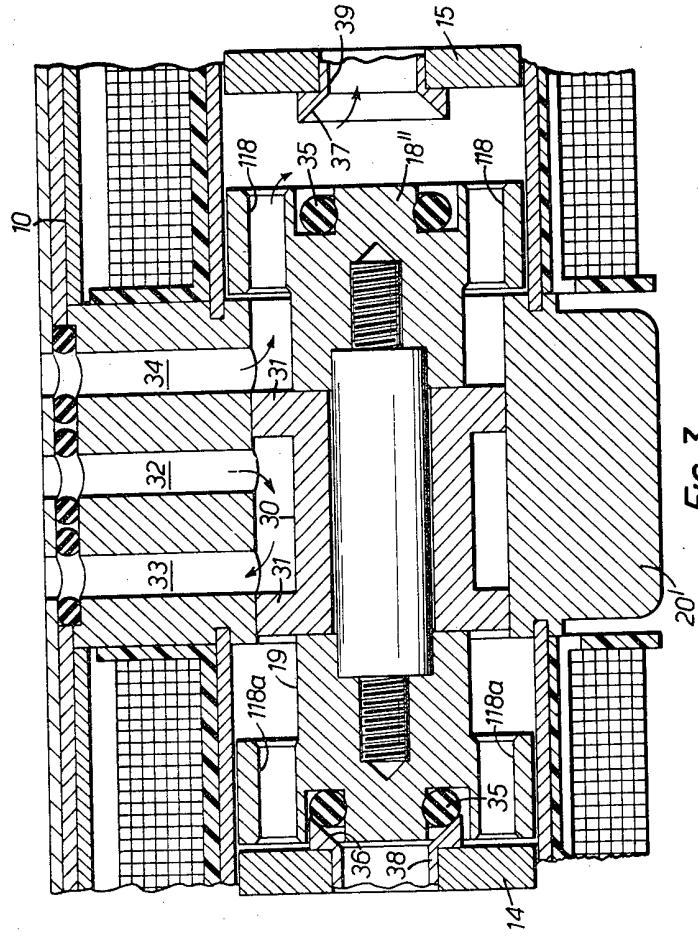

FIG. 2.



1591471

COMPLETE SPECIFICATION

7 SHEETS

This drawing is a reproduction of
the Original on a reduced scale
Sheet 4

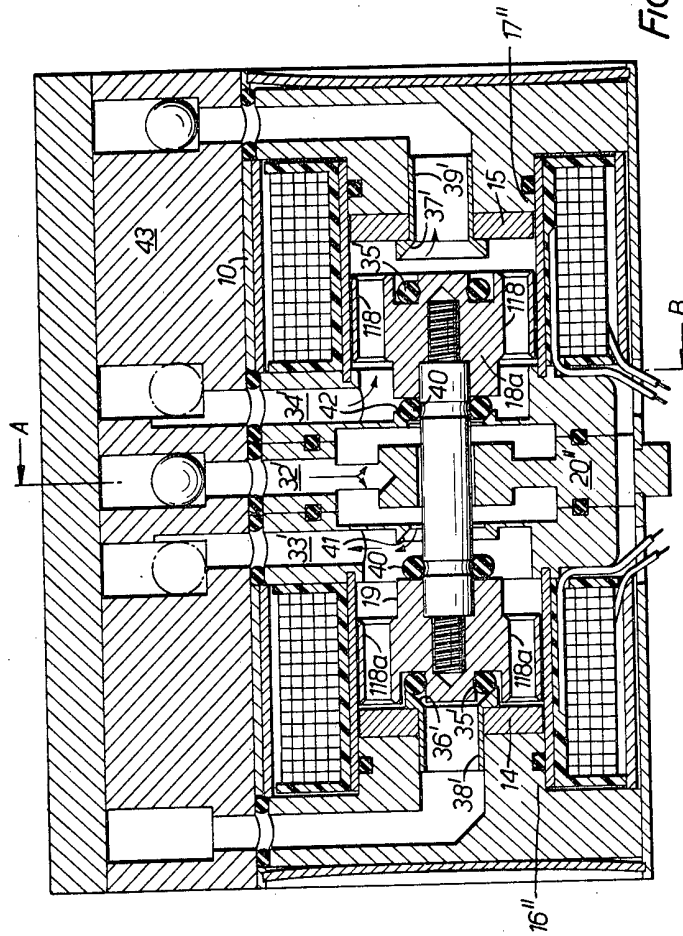

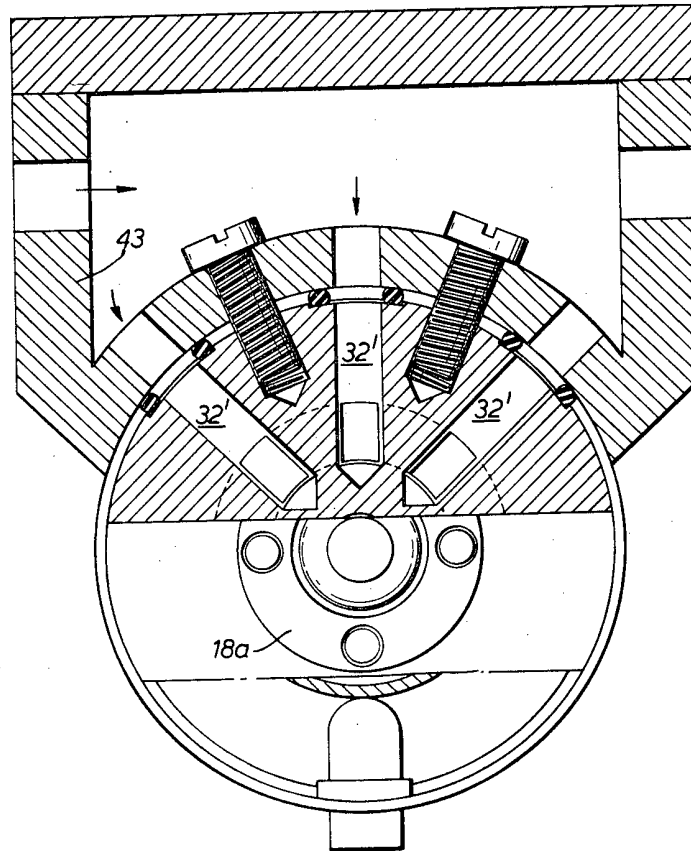

FIG. 5.

FIG. 6.

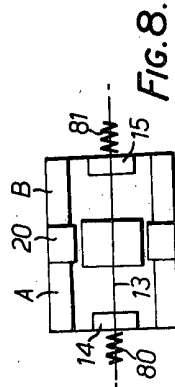
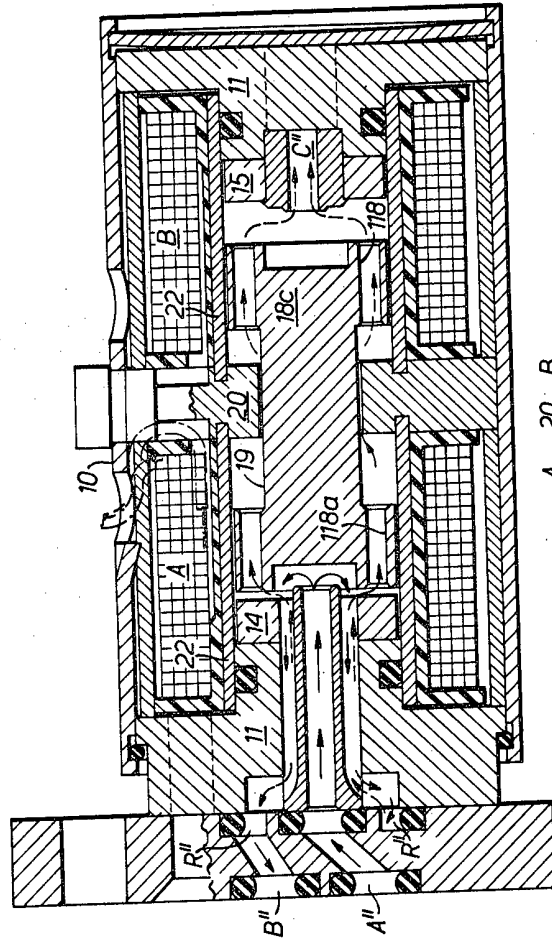

FIG. 8.

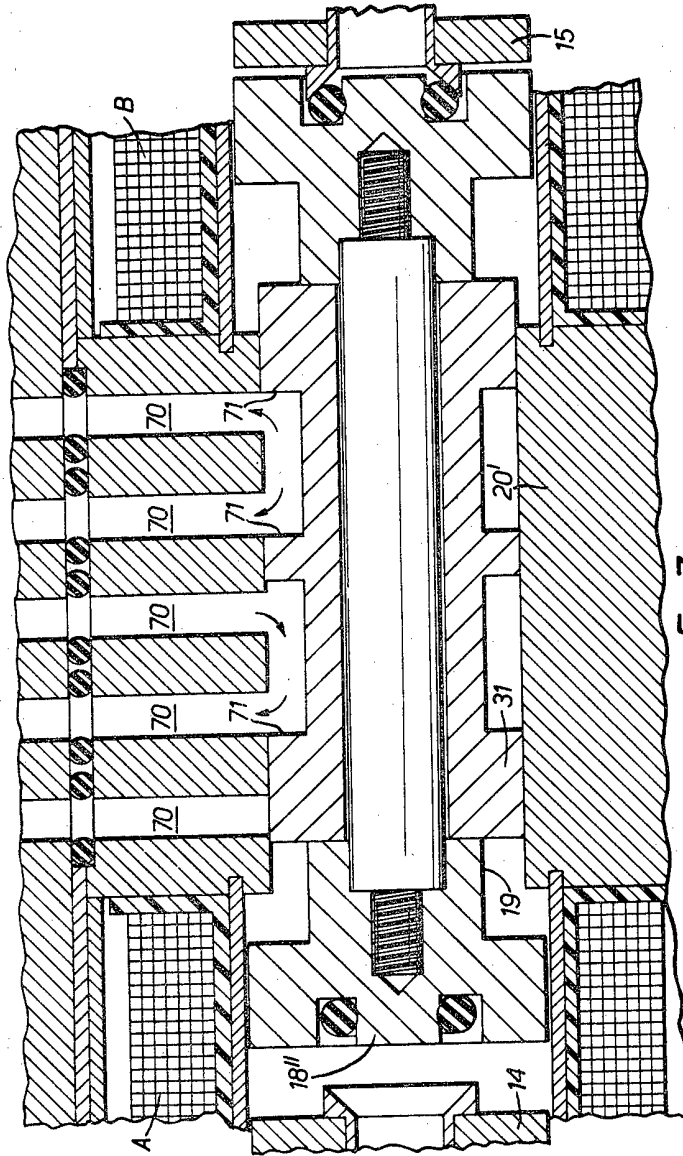

FIG. 7.