

[54] **HAND HELD SPRAYER**

[75] Inventor: **Benjamin H. Stansbury, Jr.**, Beverly Hills, Calif.

[73] Assignee: **Modern Faucet Mfg. Co.**, Los Angeles, Calif.

[**] Term: **14 Years**

[21] Appl. No.: **387,636**

[22] Filed: **Jul. 27, 1989**

[52] U.S. Cl. **D23/226**

[58] Field of Search **D23/213, 200, 223-229; 239/414-415, 301, 332, 373, 394, 525-526, 588-589, 598, 283**

[56] **References Cited**

U.S. PATENT DOCUMENTS

- D. 233,606 11/1974 Raub .
- D. 242,352 11/1976 Uyeda D23/226
- D. 288,228 2/1987 Shames et al. D23/226
- D. 289,545 4/1987 Koch D23/223
- D. 292,227 10/1987 Rudelick D23/226
- D. 308,093 5/1990 Mill et al. D23/226
- 4,151,957 5/1979 Gecewicz et al. 239/530 X

Primary Examiner—Susan J. Lucas
Assistant Examiner—M. H. Tung

Attorney, Agent, or Firm—Lackebach Siegel Marzullo & Aronson

[57] **CLAIM**

The ornamental design for a hand held sprayer, as shown and described.

DESCRIPTION

FIG. 1 is a perspective view of a hand held sprayer showing my new design;
FIG. 2 is a side elevational view thereof;
FIG. 3 is a front elevational view thereof;
FIG. 4 is a rear elevational view thereof;
FIG. 5 is a top plan view thereof;
FIG. 6 is a bottom plan view thereof;
FIG. 7 is a fragmentary cross-sectional view thereof, taken along 7—7 of FIG. 2;
FIG. 8 is a fragmentary cross sectional view thereof, taken along 8—8 of FIG. 2;
FIG. 9 is a fragmentary cross sectional view thereof, taken along 8—8 of FIG. 2;
FIG. 10 is a fragmentary cross sectional view thereof, taken along 10—10 of FIG. 2;
FIG. 11 is a fragmentary cross sectional view thereof, taken along 11—11 of FIG. 2;
FIG. 12 is a cross sectional view thereof, taken along 12—12 of FIG. 2.

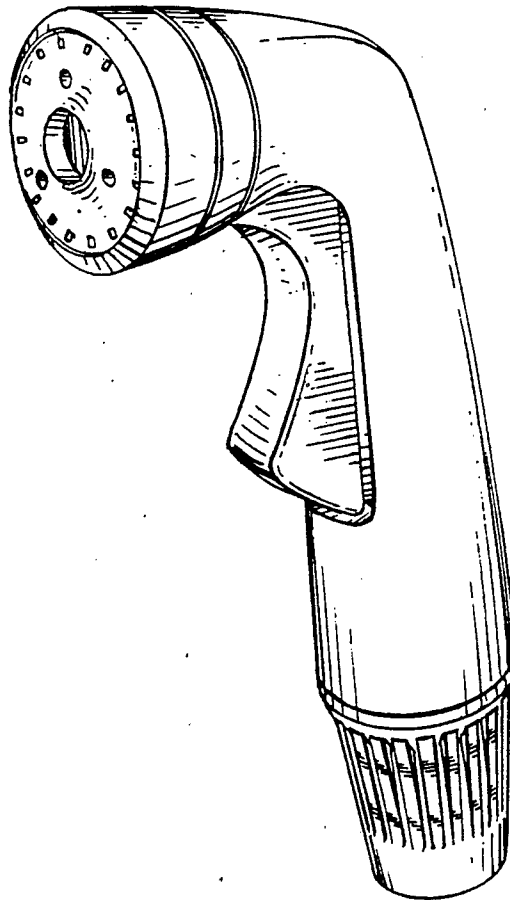

FIG. 1

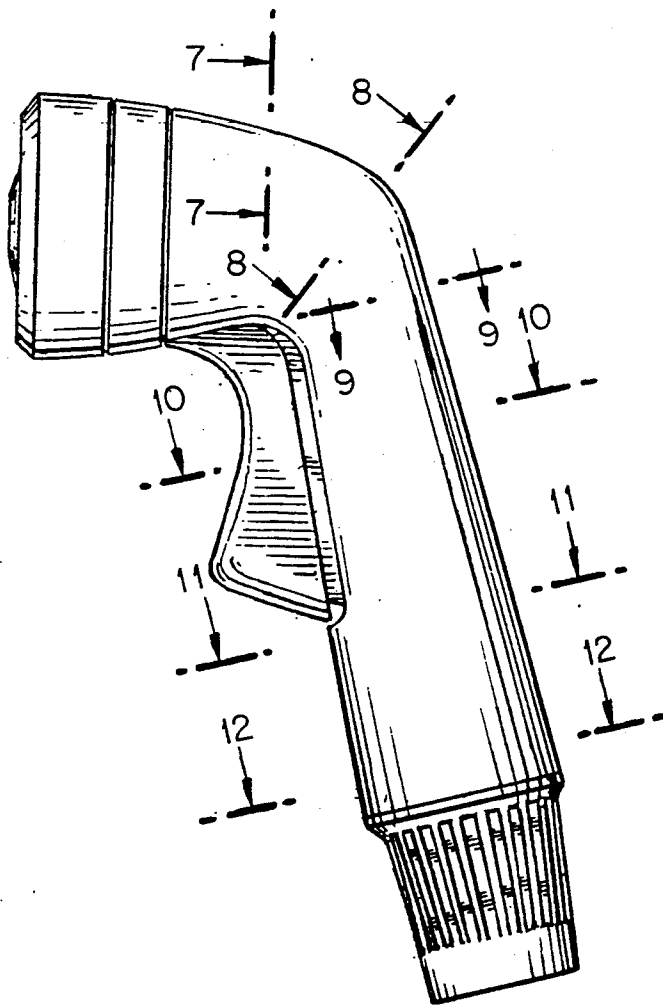
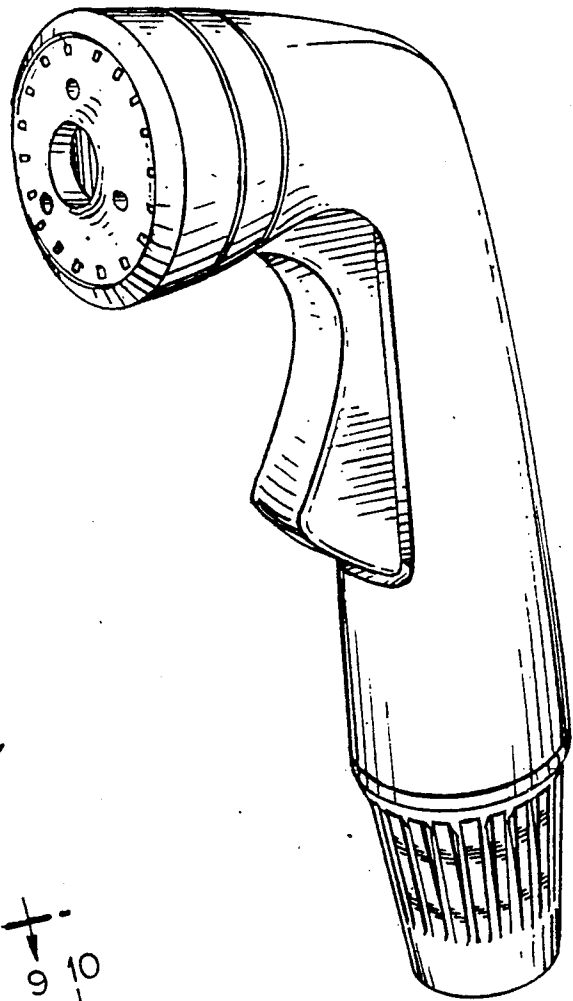

FIG. 2

FIG. 3

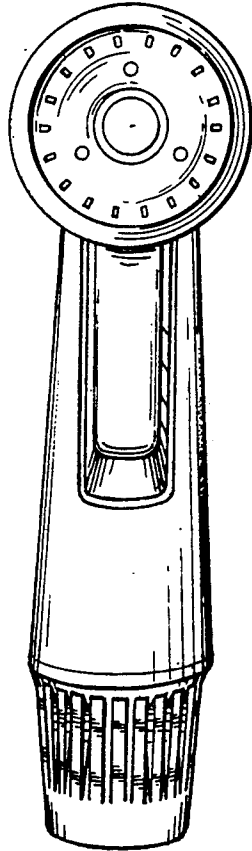

FIG. 4

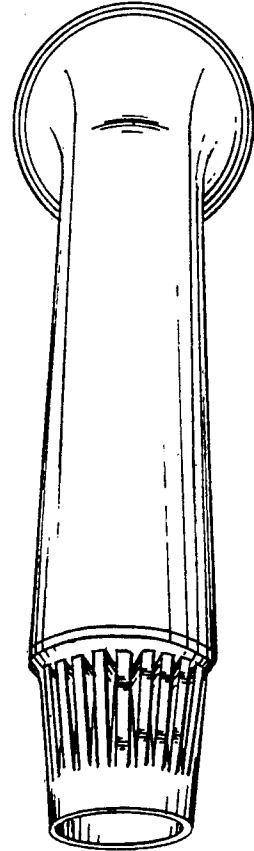

FIG. 5

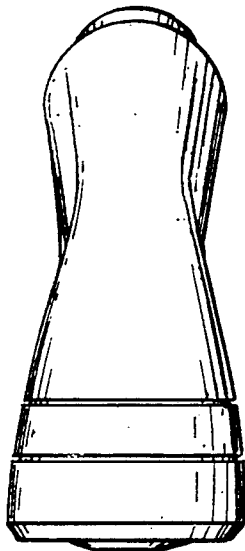

FIG. 6

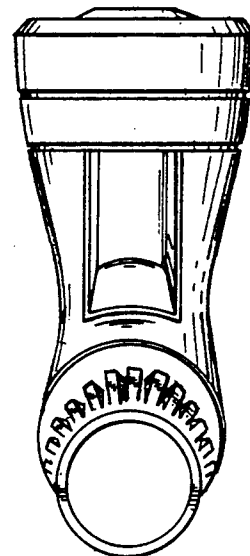

FIG. 7

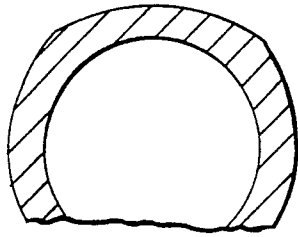

FIG. 8

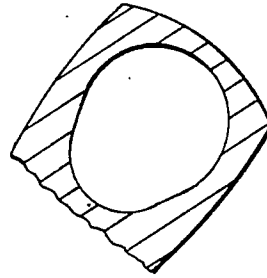

FIG. 9

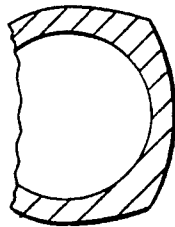

FIG. 10

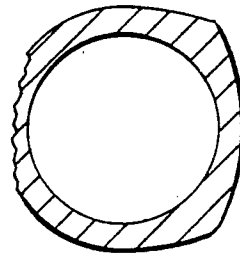

FIG. 11

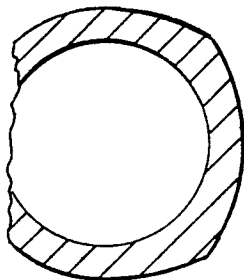

FIG. 12

