



US00D632292S

(12) **United States Design Patent**  
**Yang et al.**

(10) **Patent No.:** **US D632,292 S**

(45) **Date of Patent:** **\*\* Feb. 8, 2011**

(54) **CARD READER**

(75) Inventors: **Tianzhu Yang**, Shenzhen (CN);  
**Zhixiong Li**, Shenzhen (CN)

(73) Assignee: **Shenzhen Netcom Electronics Co., Ltd.**, Shenzhen (CN)

(\*\*) Term: **14 Years**

(21) Appl. No.: **29/346,111**

(22) Filed: **Oct. 27, 2009**

(51) **LOC (9) Cl.** ..... **14-02**

(52) **U.S. Cl.** ..... **D14/385**

(58) **Field of Classification Search** ..... D14/383–389,  
D14/356–358, 361, 363, 432–438; 235/441,  
235/451, 492, 380, 439, 375; 361/679.31,  
361/600, 679.01, 679.02

See application file for complete search history.

(56) **References Cited**

U.S. PATENT DOCUMENTS

D408,378 S *	4/1999	Tyler et al.	.....	D14/438
D410,916 S *	6/1999	Oba	.....	D14/432
D445,422 S *	7/2001	Hsin	.....	D14/385
D467,921 S *	12/2002	Lin	.....	D14/385
D496,364 S *	9/2004	Saito	.....	D14/385
D503,172 S *	3/2005	Izumi	.....	D14/385
D529,029 S *	9/2006	Sekine	.....	D14/433
D545,310 S *	6/2007	Chen	.....	D14/480.5
D546,325 S *	7/2007	Chen	.....	D14/356

D546,326 S *	7/2007	Chen	.....	D14/356
D558,199 S *	12/2007	Fiorentino	.....	D14/356
D574,384 S *	8/2008	Knoch	.....	D14/436
D594,866 S *	6/2009	Lin	.....	D14/385
D603,410 S *	11/2009	Knoch	.....	D14/436
D610,156 S *	2/2010	Mudrick	.....	D14/480.5
7,659,607 B2 *	2/2010	Iwasaki	.....	257/679
2003/0089773 A1 *	5/2003	Kanayama	.....	235/449

\* cited by examiner

*Primary Examiner*—Cathron C Brooks

*Assistant Examiner*—Deanna Fluegeman

(74) *Attorney, Agent, or Firm*—Hamre, Schumann, Mueller & Larson, P.C.

(57) **CLAIM**

The ornamental design for a “card reader,” as shown and described.

**DESCRIPTION**

FIG. 1 is a front, top and right side perspective view of a card reader showing our new design;

FIG. 2 is a front elevational view thereof;

FIG. 3 is a rear elevational view thereof;

FIG. 4 is a left side elevational view thereof;

FIG. 5 is a right side elevational view thereof;

FIG. 6 is a top plan view thereof; and,

FIG. 7 is a bottom plan view thereof.

**1 Claim, 7 Drawing Sheets**

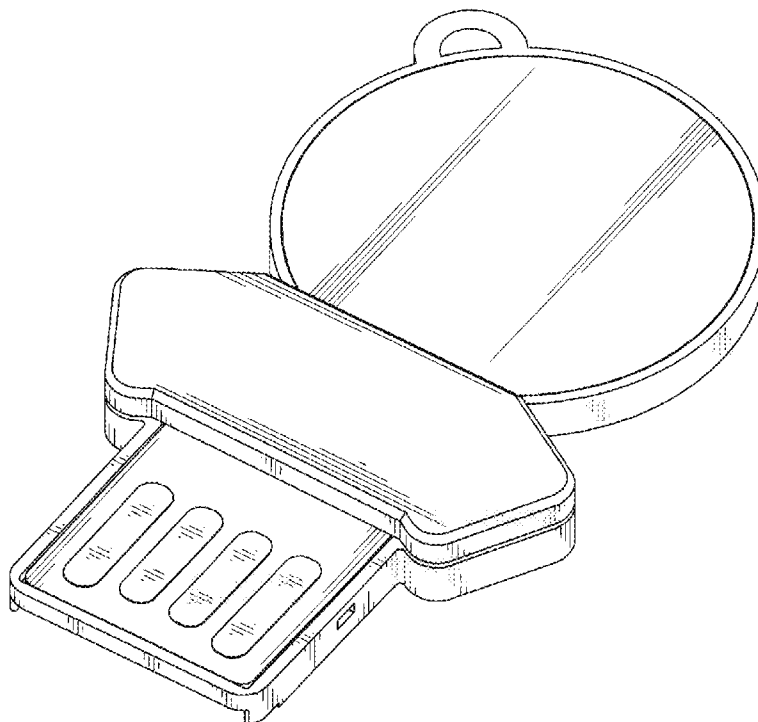

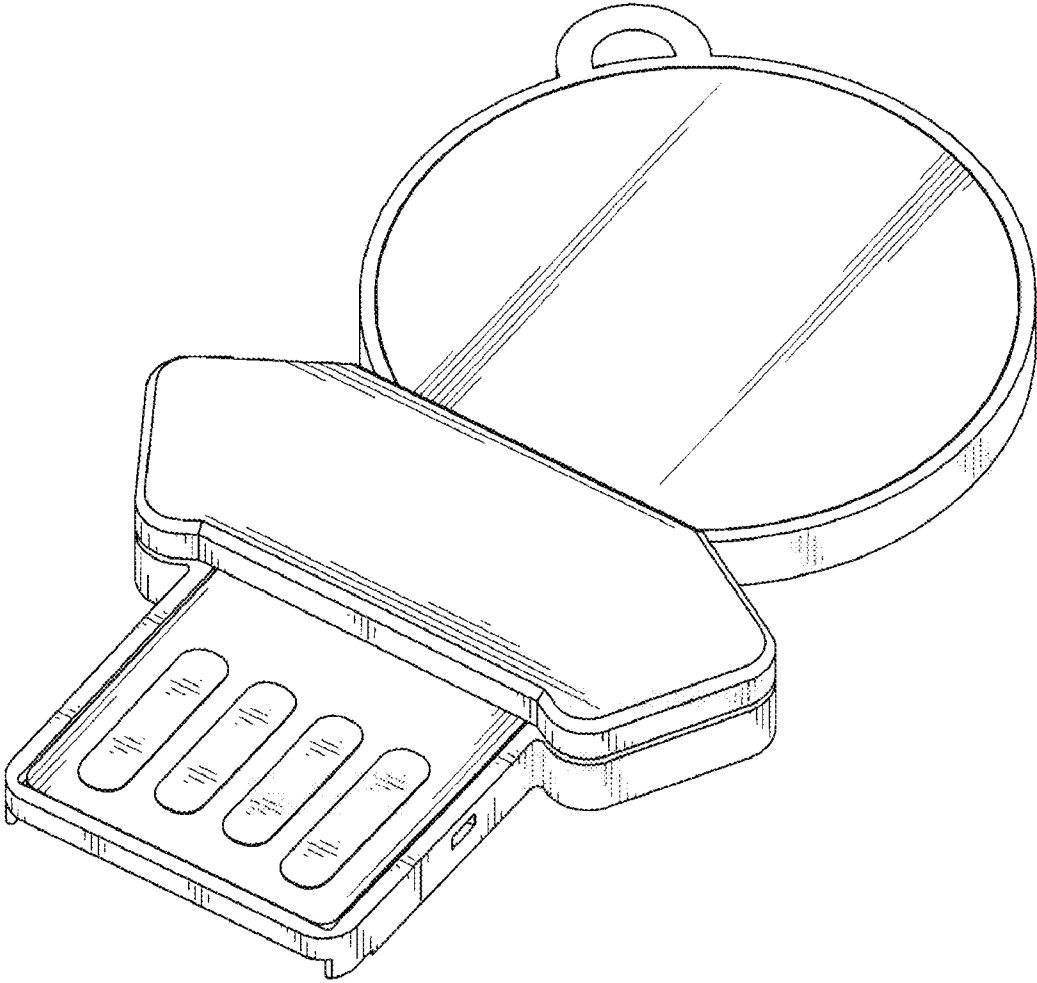

FIG. 1

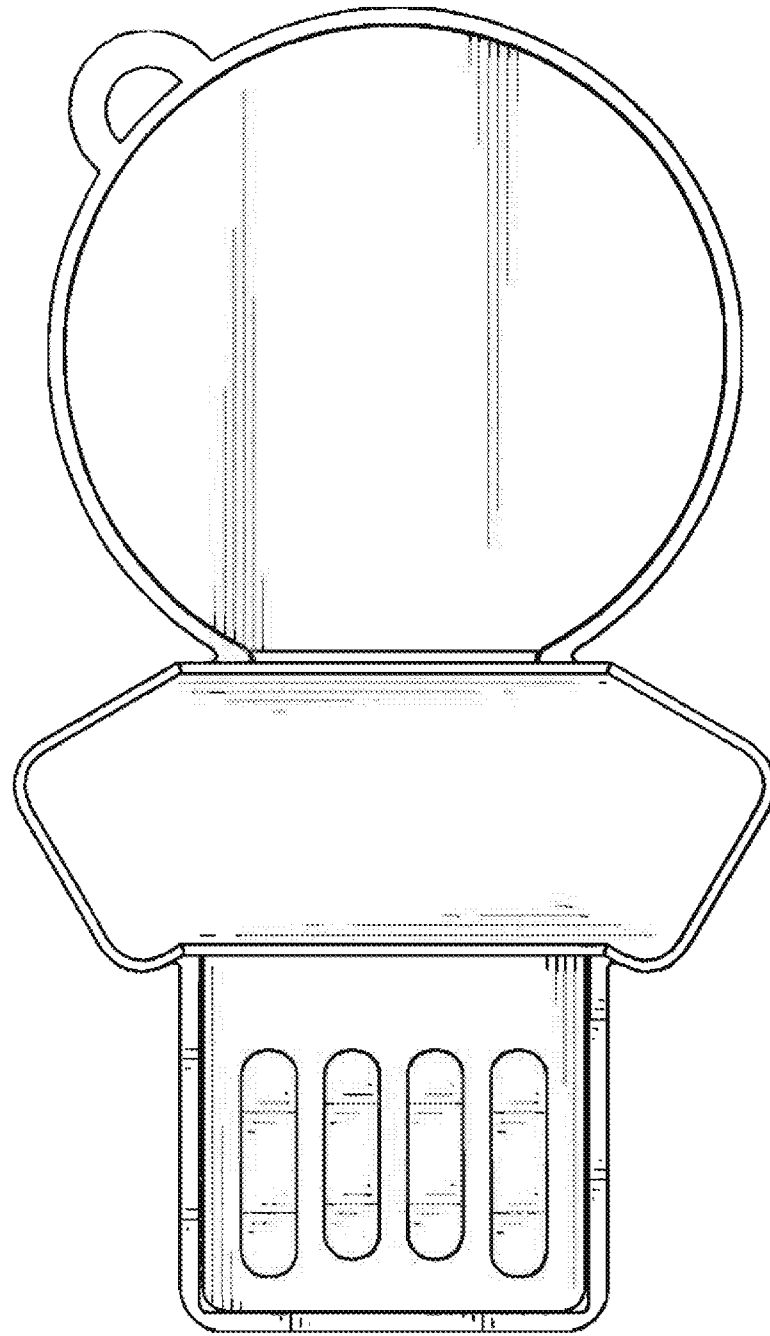

FIG. 2

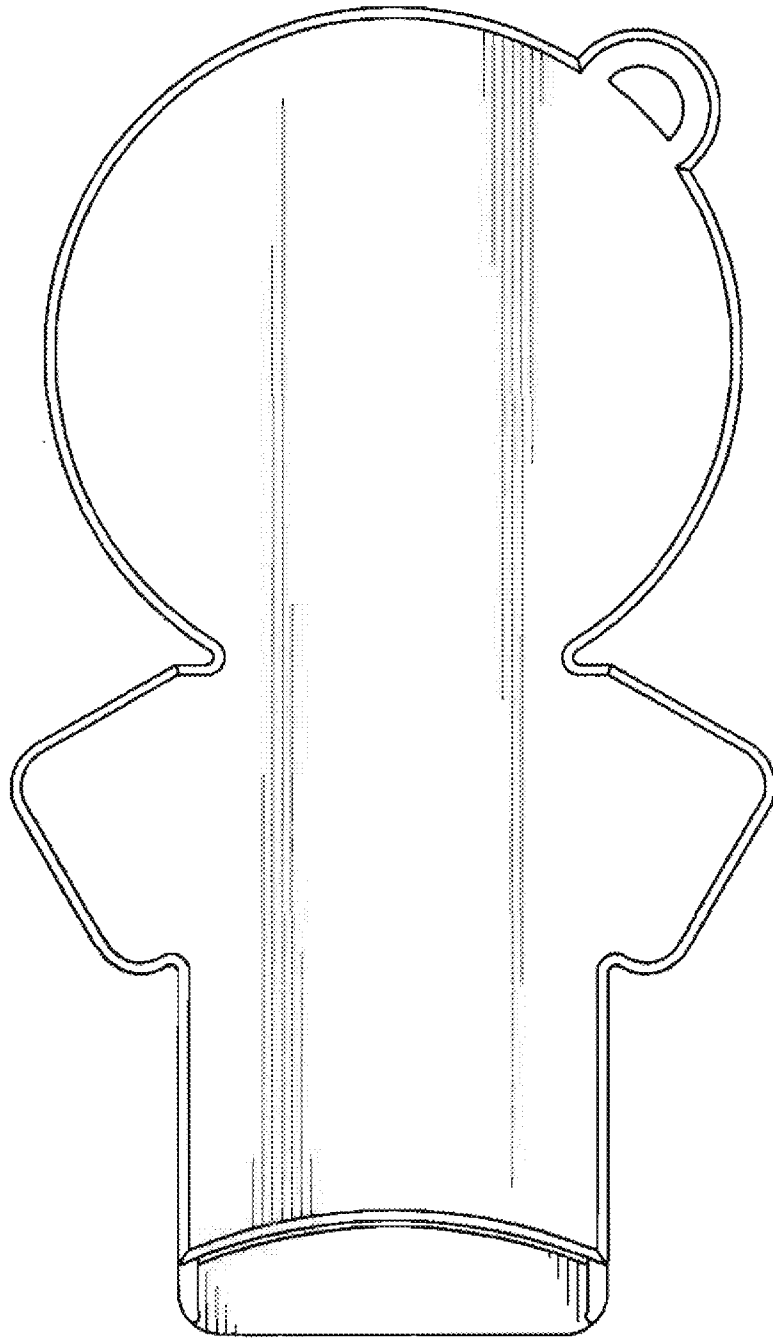

FIG. 3

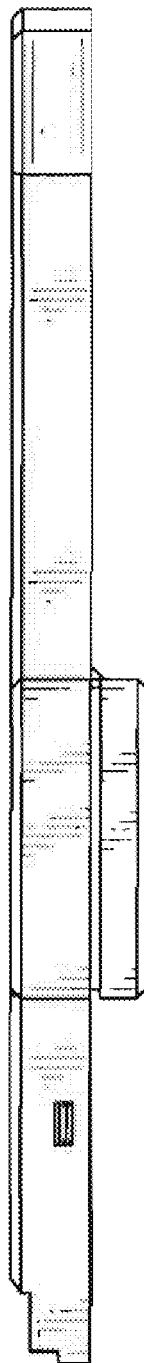

FIG. 4

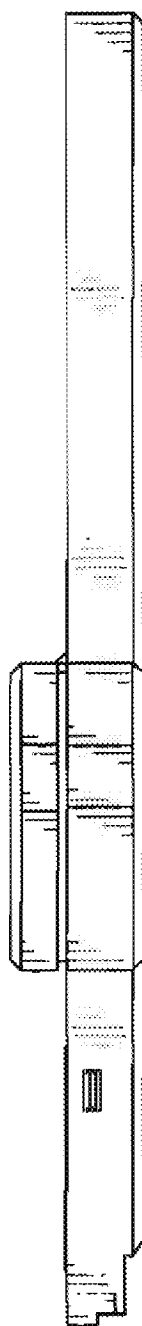

FIG. 5

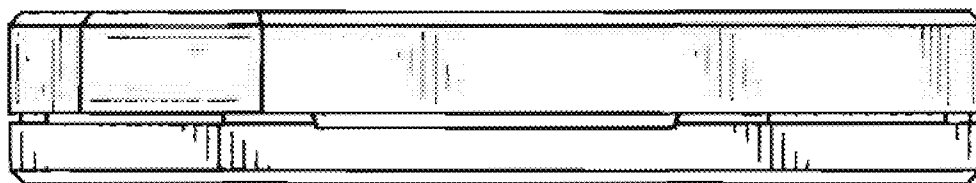

FIG. 6

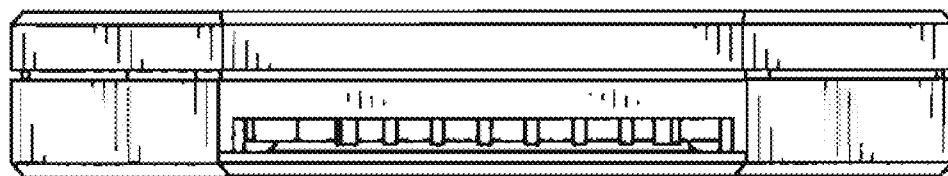

FIG. 7