



US00D463641S

(12) **United States Design Patent** (10) **Patent No.:** **US D463,641 S**  
**Powell** (45) **Date of Patent:** **\*\* Sep. 24, 2002**

- (54) **STEAM STATION BASE**
- (75) **Inventor:** **Dick Powell, London (GB)**
- (73) **Assignee:** **Calor S.A., Lyons (FR)**
- (\*\*) **Term:** **14 Years**
- (21) **Appl. No.:** **29/145,494**
- (22) **Filed:** **Jul. 25, 2001**
- (30) **Foreign Application Priority Data**  
Jan. 25, 2001 (FR) ..... 01 0452
- (51) **LOC (7) Cl. .... 07-03**
- (52) **U.S. Cl. .... D32/71; D32/73**
- (58) **Field of Search .... D32/68, 71, 73;**  
**38/75, 77.5, 77.6, 77.7, 79, 96, 141, 142;**  
**219/245-247, 259; 248/117.1, 117.2, 117.3;**  
**392/394, 403, 404**

D408,107 S \* 4/1999 Clouet ..... D32/73  
 D439,023 S 3/2001 Powell  
 6,212,332 B1 \* 4/2001 Sham et al. .... 392/404

**FOREIGN PATENT DOCUMENTS**

GB 2330843 \* 5/1999  
 WO WO 01/53596 \* 7/2001

\* cited by examiner

*Primary Examiner*—Alan P. Douglas

*Assistant Examiner*—Lavone Tabor

(74) *Attorney, Agent, or Firm*—Browdy and Neimark, P.L.L.C.

**CLAIM**

(57) The ornamental design for a steam station base, as shown and described.

**DESCRIPTION**

FIG. 1 is a perspective view of a steam station base in accordance with the present design;  
 FIG. 2 is a right side view thereof;  
 FIG. 3 is a left side view thereof;  
 FIG. 4 is a front view thereof;  
 FIG. 5 is a rear view thereof;  
 FIG. 6 is top plan view thereof; and,  
 FIG. 7 is a bottom plan view thereof.

**1 Claim, 7 Drawing Sheets**

- (56) **References Cited**  
**U.S. PATENT DOCUMENTS**  
374,527 A 12/1887 Emerson  
388,576 A 8/1888 Nordenfelt  
D370,324 S \* 5/1996 Villa ..... D32/73  
D374,527 S \* 10/1996 Gudefin ..... D32/68  
D379,702 S \* 6/1997 Gudefin et al. .... D32/73

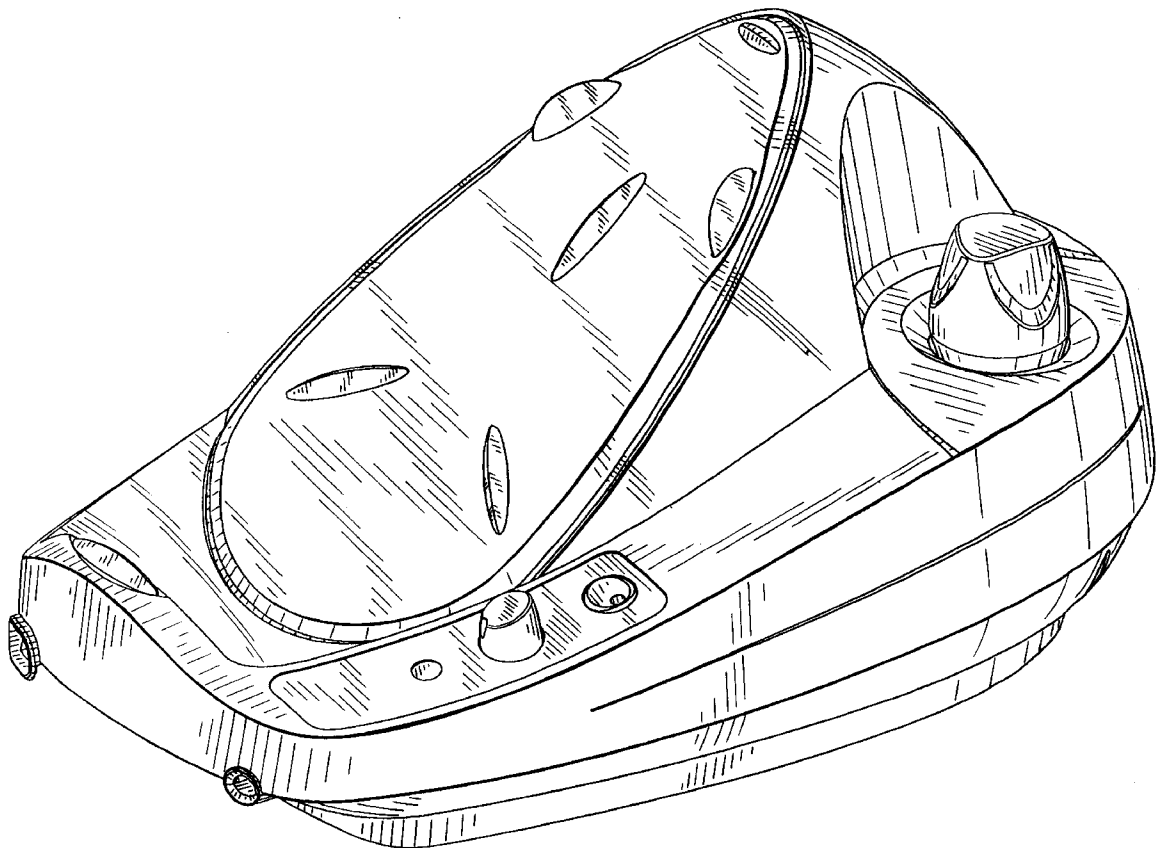

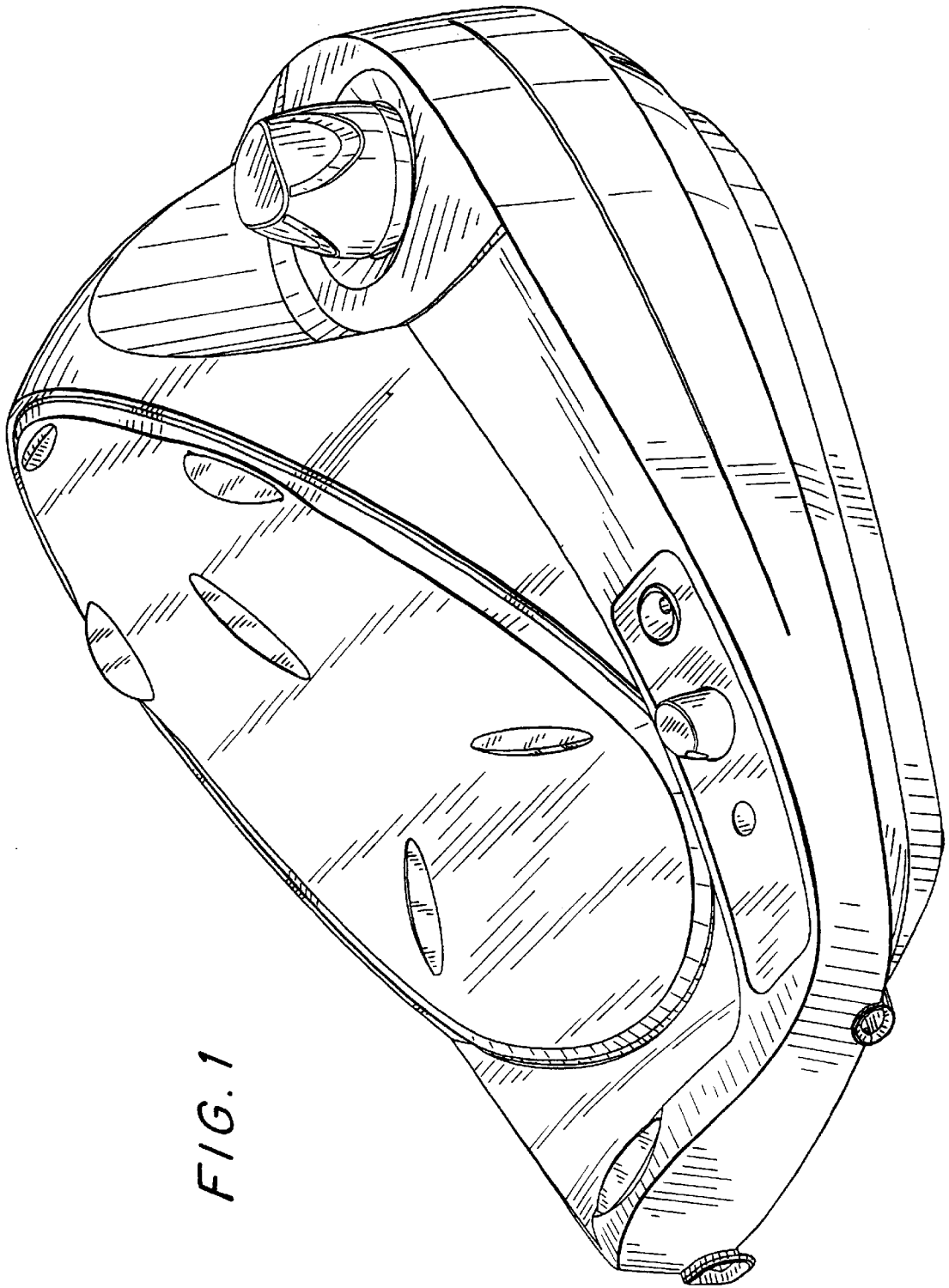

FIG. 1

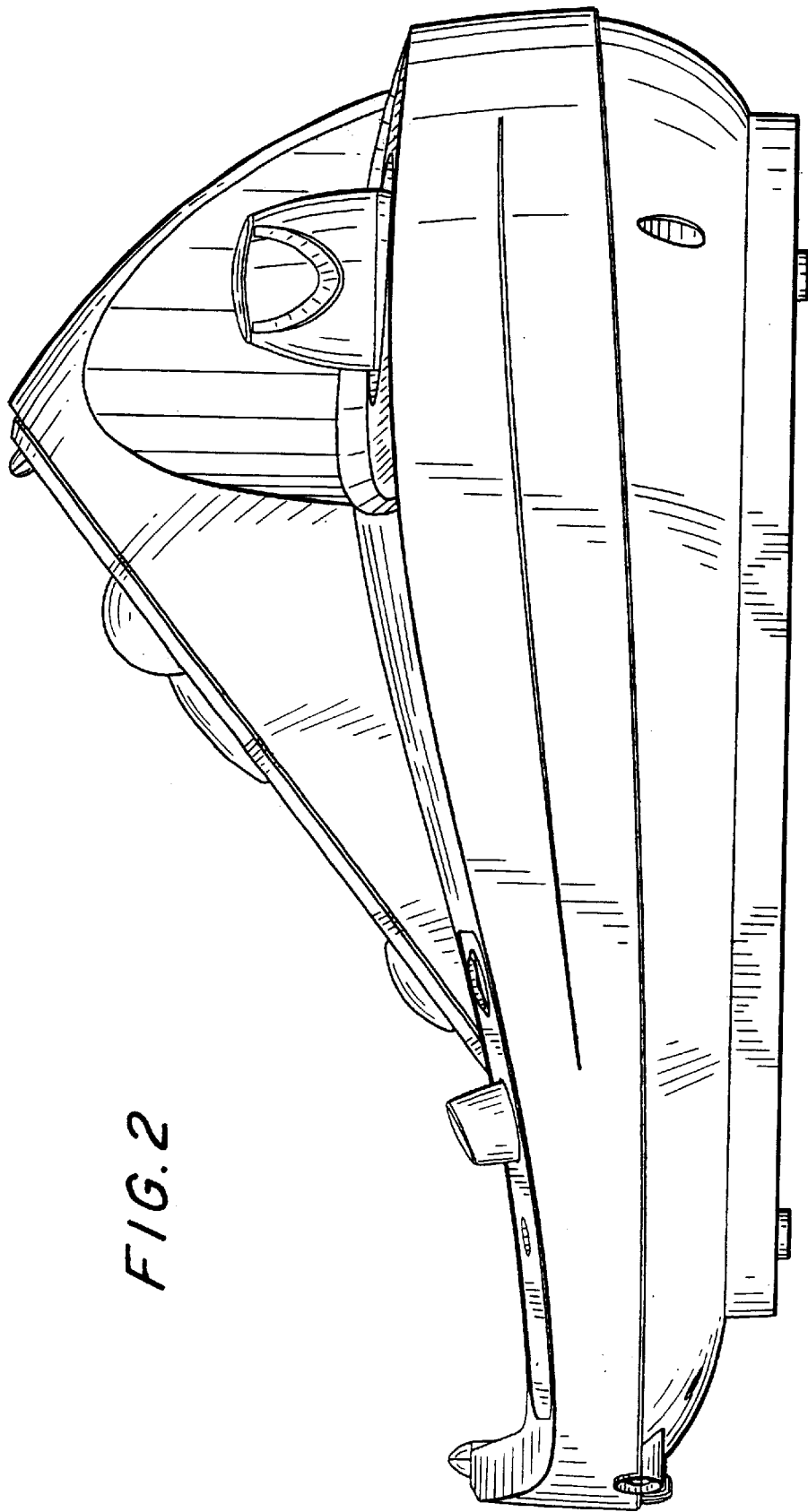

FIG. 2

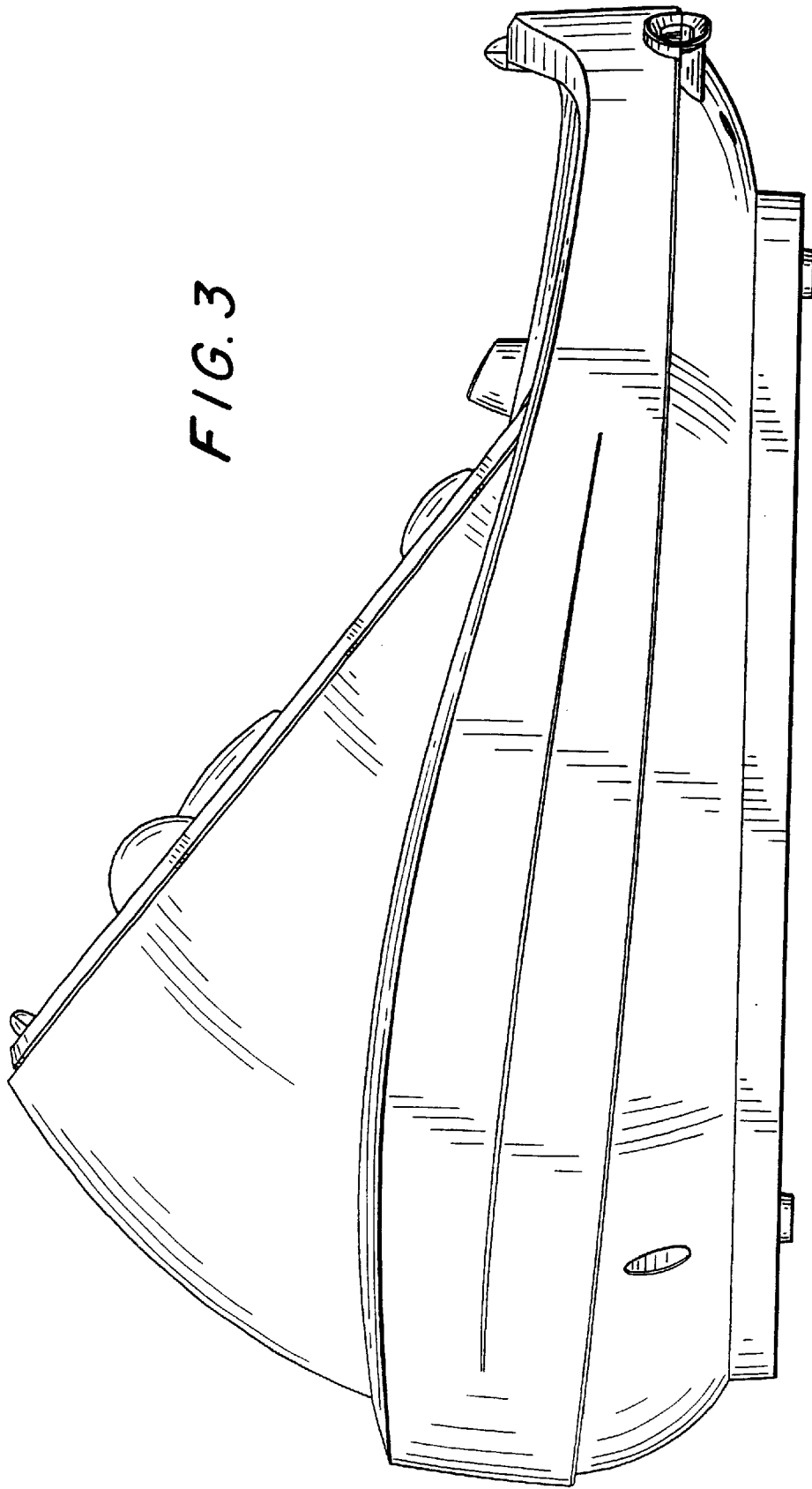

FIG. 3

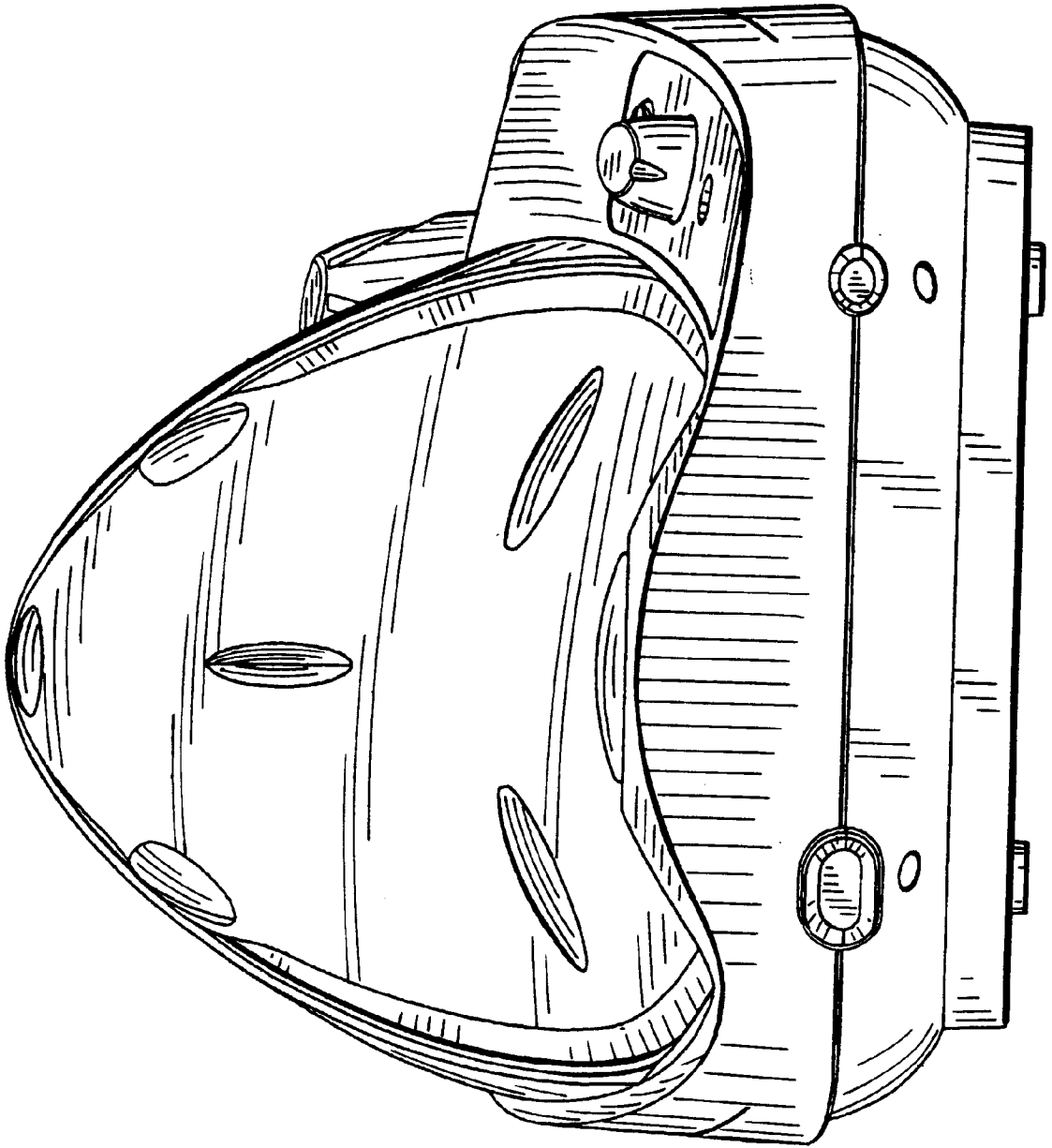

FIG. 4

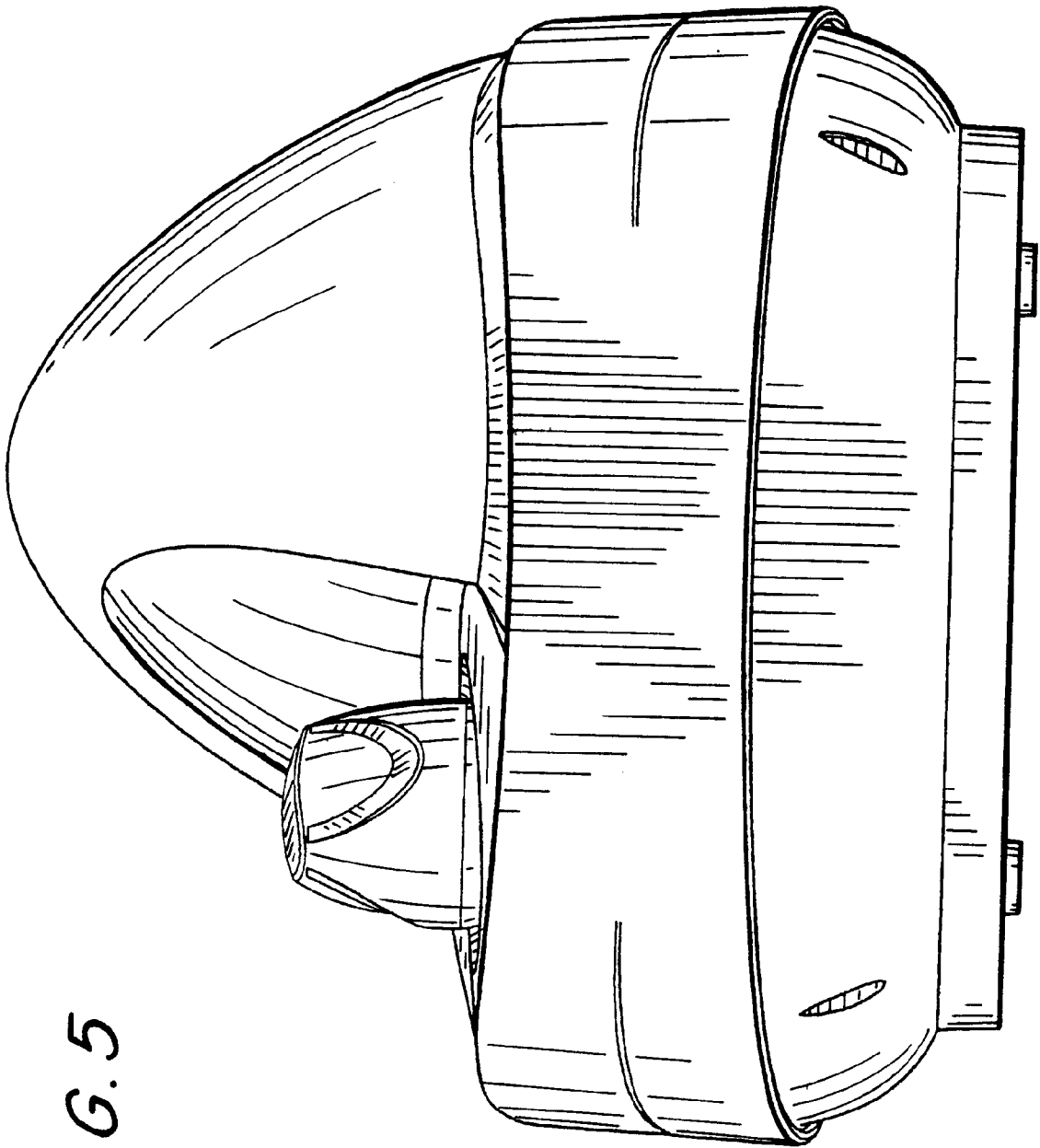

FIG. 5

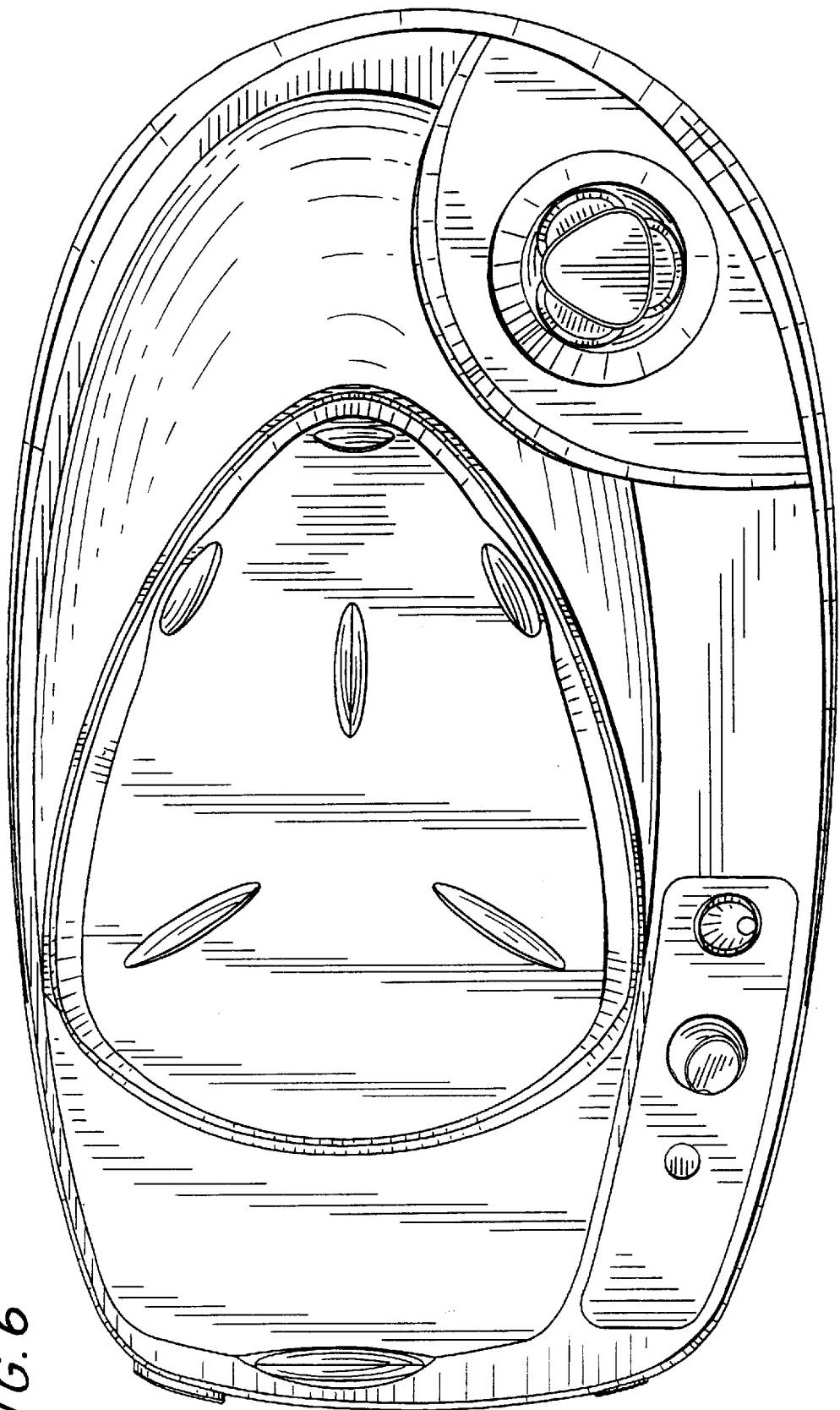

FIG. 6

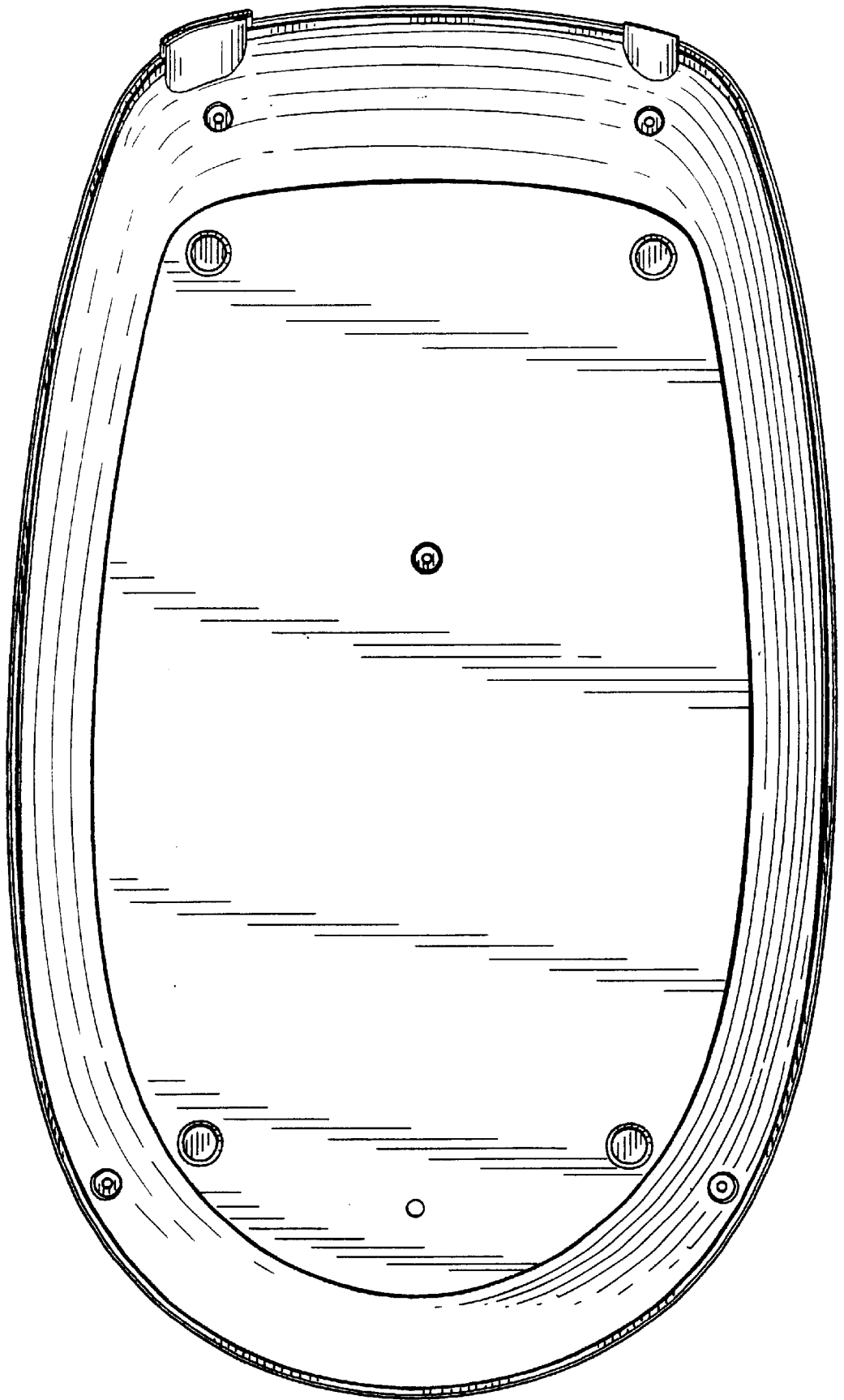

FIG. 7