



US00D577261S

(12) **United States Design Patent**
Wang

(10) **Patent No.:** **US D577,261 S**

(45) **Date of Patent:** **** Sep. 23, 2008**

(54) **VACUUMED FOOD CONTAINER**
(75) Inventor: **Tie-Chun Wang**, SanChung (TW)
(73) Assignee: **Michilin Prosperity Co., Ltd.**,
Sanchung, Taipei Hsien (TW)

6,568,347 B2 * 5/2003 Ciguere 206/541
6,786,351 B2 * 9/2004 Krueger 220/571
D502,394 S * 3/2005 Jackson et al. D9/425
D527,227 S * 8/2006 Bertulis D7/629
D527,956 S * 9/2006 Doliwa D7/629
D550,516 S * 9/2007 Tsai D7/629

(**) Term: **14 Years**

* cited by examiner

(21) Appl. No.: **29/274,565**

Primary Examiner—Terry A Wallace

(74) *Attorney, Agent, or Firm*—Bacon & Thomas, PLLC.

(22) Filed: **May 3, 2007**

(57) **CLAIM**

(30) **Foreign Application Priority Data**

The ornamental design for vacuumed food container, as shown and described.

Dec. 31, 2006 (CN) 2006 3 0315793

(51) **LOC (8) Cl.** **07-01**

(52) **U.S. Cl.** **D7/629**

(58) **Field of Classification Search** D7/602,
D7/629, 538–542, 612–615; 220/780–806,
220/571–575; D9/424–432; 206/541–550

See application file for complete search history.

DESCRIPTION

FIG. 1 is a perspective view of vacuumed food container showing my new design;

FIG. 2 is a front elevational view thereof;

FIG. 3 is a rear elevational view thereof;

FIG. 4 is a left side elevational view thereof;

FIG. 5 is a right side elevational view thereof;

FIG. 6 is a top plan view thereof; and,

FIG. 7 is a bottom plan view thereof.

(56) **References Cited**

U.S. PATENT DOCUMENTS

3,372,690 A * 3/1968 Ruiz 206/544
4,147,277 A * 4/1979 Bateman et al. 220/574.2
D472,774 S * 4/2003 Pelstring et al. D7/629

1 Claim, 4 Drawing Sheets

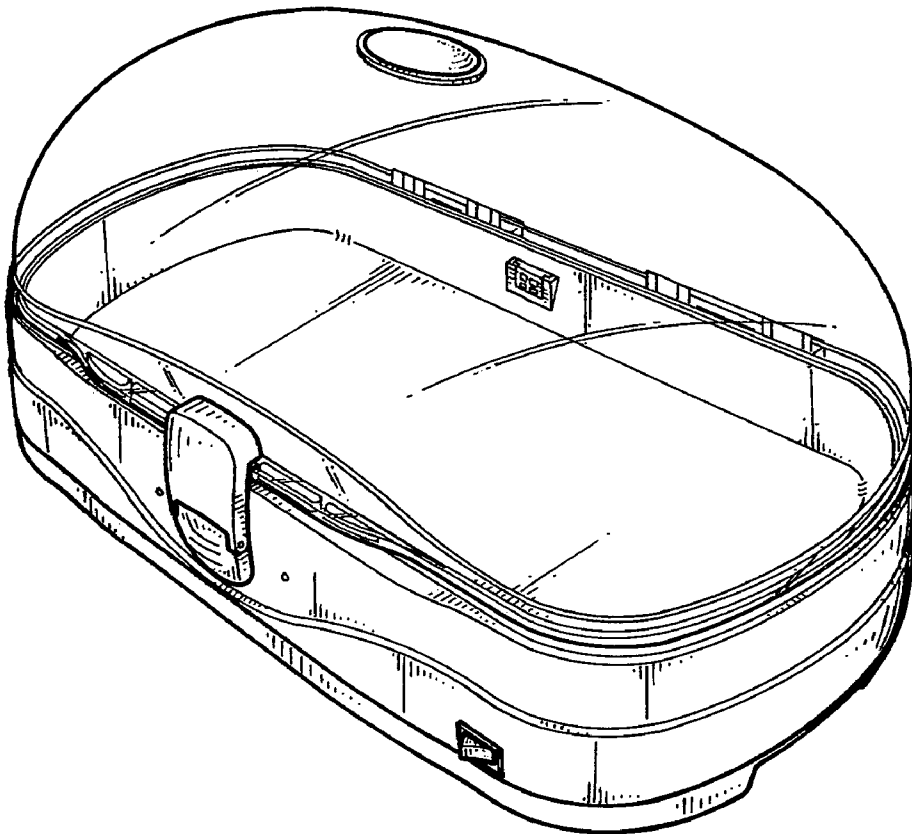

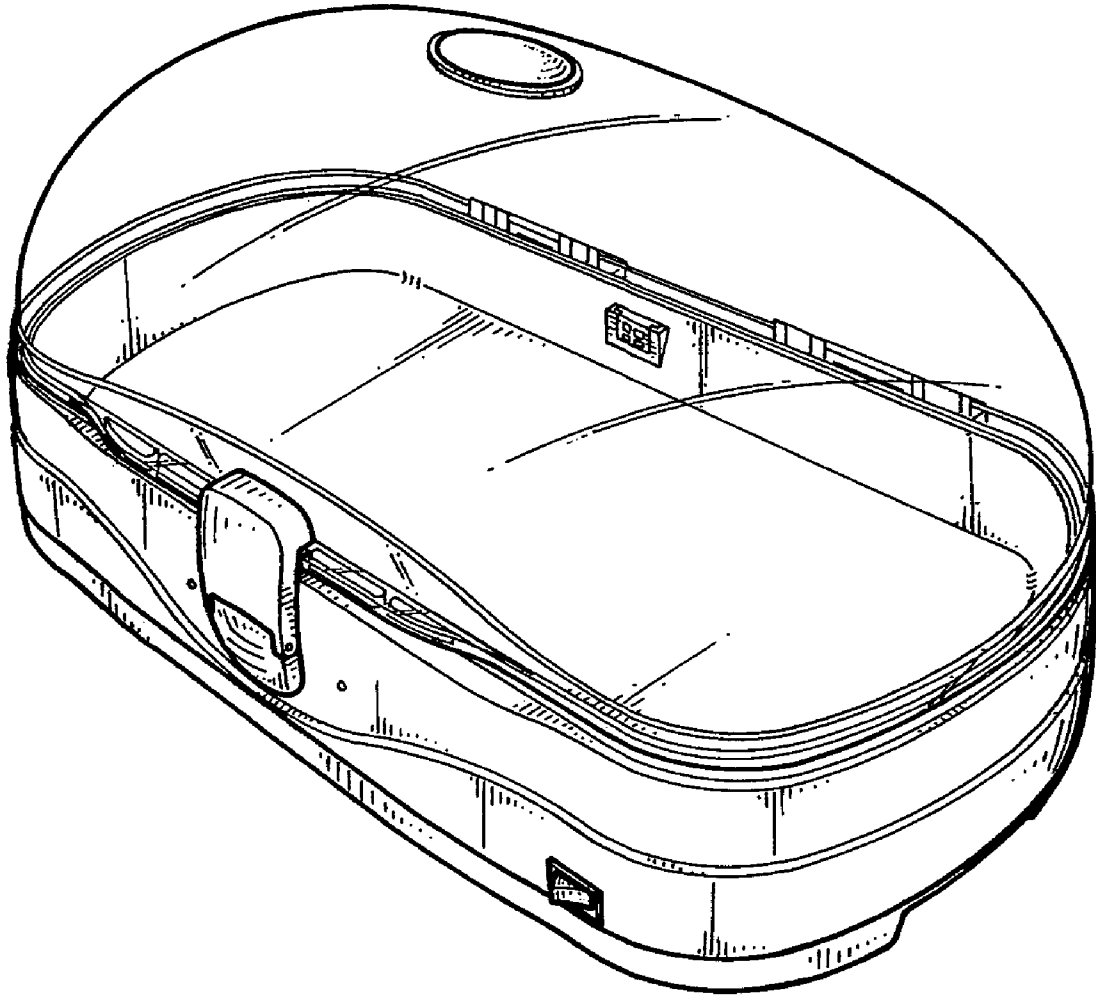

Fig. 1

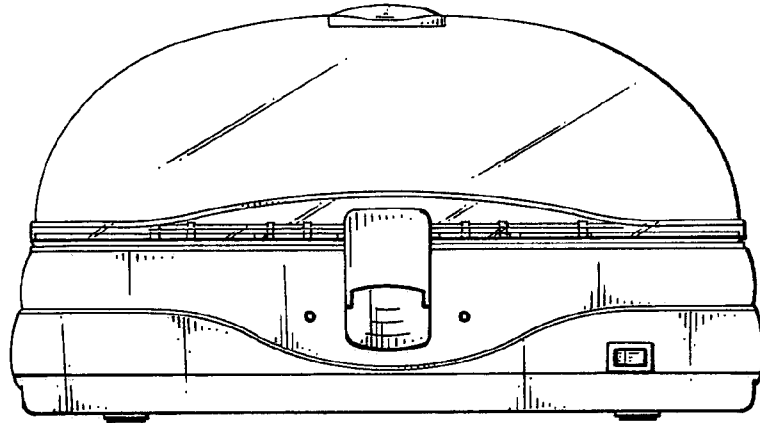

Fig. 2

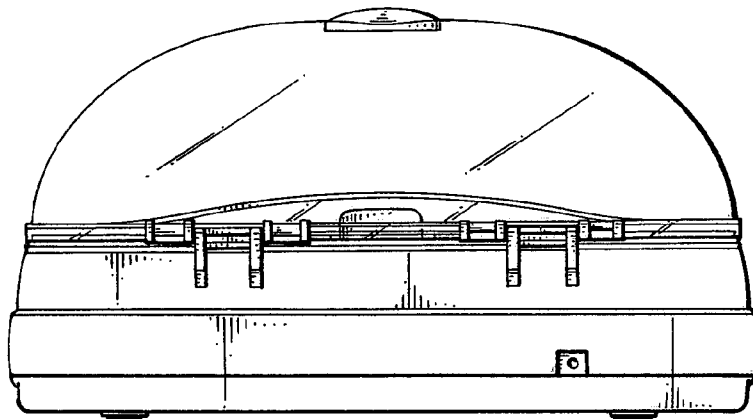

Fig. 3

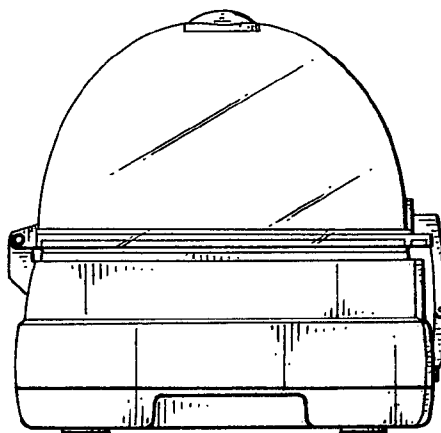

Fig. 4

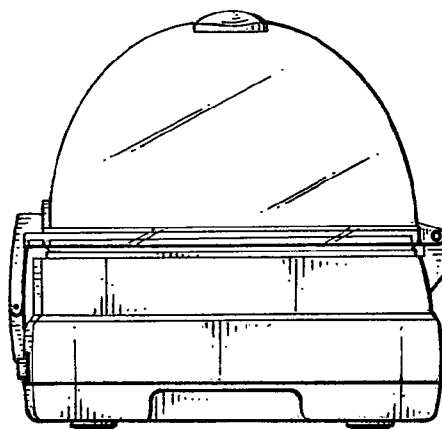

Fig. 5

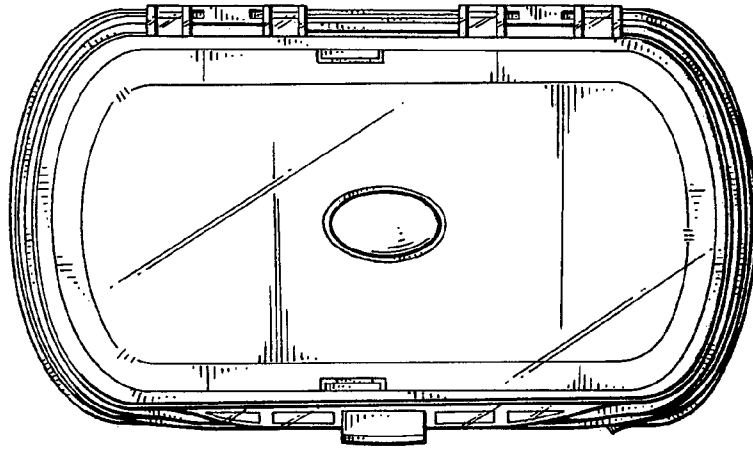

Fig. 6

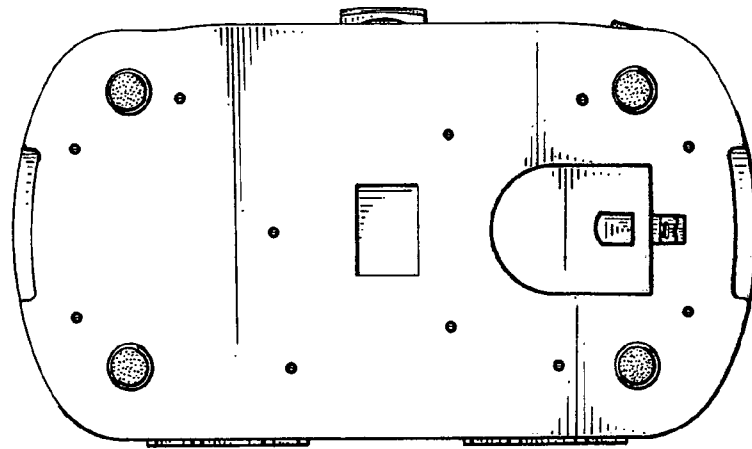

Fig. 7