



US00D855168S

(12) **United States Design Patent**
Hyon et al.

(10) **Patent No.:** **US D855,168 S**

(45) **Date of Patent:** **** Jul. 30, 2019**

(54) **HUMIDIFYING AIR PURIFIER**
(71) Applicant: **LG ELECTRONICS INC.**, Seoul (KR)
(72) Inventors: **Chinsoo Hyon**, Seoul (KR); **Seungho Back**, Seoul (KR); **Yunseo Jang**, Seoul (KR); **Jaeyeong Jo**, Seoul (KR)
(73) Assignee: **LG ELECTRONICS INC.**, Seoul (KR)
(**) Term: **15 Years**

D537,512 S *	2/2007	Nakajima	D23/359
D549,308 S *	8/2007	Chiu	D23/333
D550,343 S *	9/2007	Chen	D23/364
D557,783 S *	12/2007	Yoo	D23/359
D572,352 S *	7/2008	Chiu	D23/333
D575,857 S *	8/2008	Chiu	D23/333
D578,629 S *	10/2008	Yoo	D23/333
D578,632 S *	10/2008	Chen	D23/364
D586,451 S *	2/2009	Murai	D23/364
D587,794 S *	3/2009	Yoo	D23/359
D589,132 S *	3/2009	Chiu	D23/333
D617,437 S *	6/2010	Matsuzaki	D23/364
D635,655 S *	4/2011	Chen	D23/364

(Continued)

(21) Appl. No.: **35/504,909**
(22) Filed: **Nov. 9, 2017**

Primary Examiner — Richard E Chilcot
(74) *Attorney, Agent, or Firm* — Birch, Stewart, Kolasch & Birch, LLP

(80) **Hague Agreement Data**
Int. Filing Date: **Nov. 9, 2017**
Int. Reg. No.: **DM/099802**
Int. Reg. Date: **Nov. 9, 2017**
Int. Reg. Pub. Date: **May 11, 2018**

(57) **CLAIM**

The ornamental design for a humidifying air purifier, as shown and described.

(30) **Foreign Application Priority Data**
May 10, 2017 (KR) 30-2017-0020946
(51) **LOC (11) Cl.** **23-04**
(52) **U.S. Cl.**
USPC **D23/356**
CPC **A61L 9/00** (2013.01)
(58) **Field of Classification Search**
USPC D23/209, 210, 355-365
CPC A61L 9/00; A61L 9/02; A61L 9/03; A61L 9/034; A61L 9/04; A61L 9/12; A61L 9/032; A61L 9/122; A61L 9/127; A61L 9/22; B01D 46/00; B01D 46/0002; B01D 46/20; F02M 35/04; F24F 13/20; A62B 21/00
See application file for complete search history.

DESCRIPTION

- 1. Humidifying air purifier
- 1.1 : Perspective
- 1.2 : Front
- 1.3 : Back
- 1.4 : Left
- 1.5 : Right
- 1.6 : Top
- 1.7 : Bottom
- 1.8 : Perspective
- 1.9 : Front
- 1.10 : Back
- 1.11 : Left
- 1.12 : Right
- 1.13 : Top
- 1.14 : Bottom
- 1.15 : Reference

The broken lines indicate unclaimed portions of the article that form no part of the claimed design.

(56) **References Cited**
U.S. PATENT DOCUMENTS
D462,754 S * 9/2002 Briggs D23/364
D536,433 S * 2/2007 Murai D23/364

1 Claim, 15 Drawing Sheets

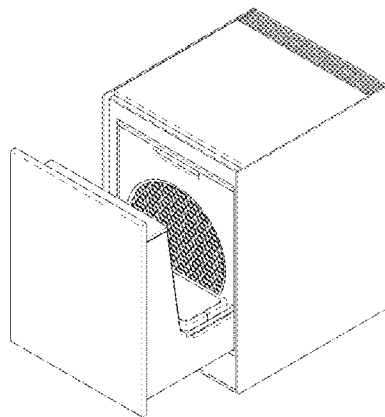

(56)

References Cited

U.S. PATENT DOCUMENTS

D656,597	S	*	3/2012	Liu	D23/356
D662,576	S	*	6/2012	Shore	D23/364
D664,247	S	*	7/2012	Paterson	D23/364
D683,439	S	*	5/2013	Choi	D23/364
D725,253	S	*	3/2015	Choi	D23/359
D737,944	S	*	9/2015	Shore	D23/364
D744,077	S	*	11/2015	Yasukochi	D23/364
D797,914	S	*	9/2017	Nygren	D23/364
D803,369	S	*	11/2017	Kim	D23/364
D806,844	S	*	1/2018	Kim	D23/364
D806,845	S	*	1/2018	Kim	D23/364
D807,998	S	*	1/2018	Kim	D23/364
D820,422	S	*	6/2018	Kim	D23/364
D821,556	S	*	6/2018	Shore	D23/364

* cited by examiner

1.1

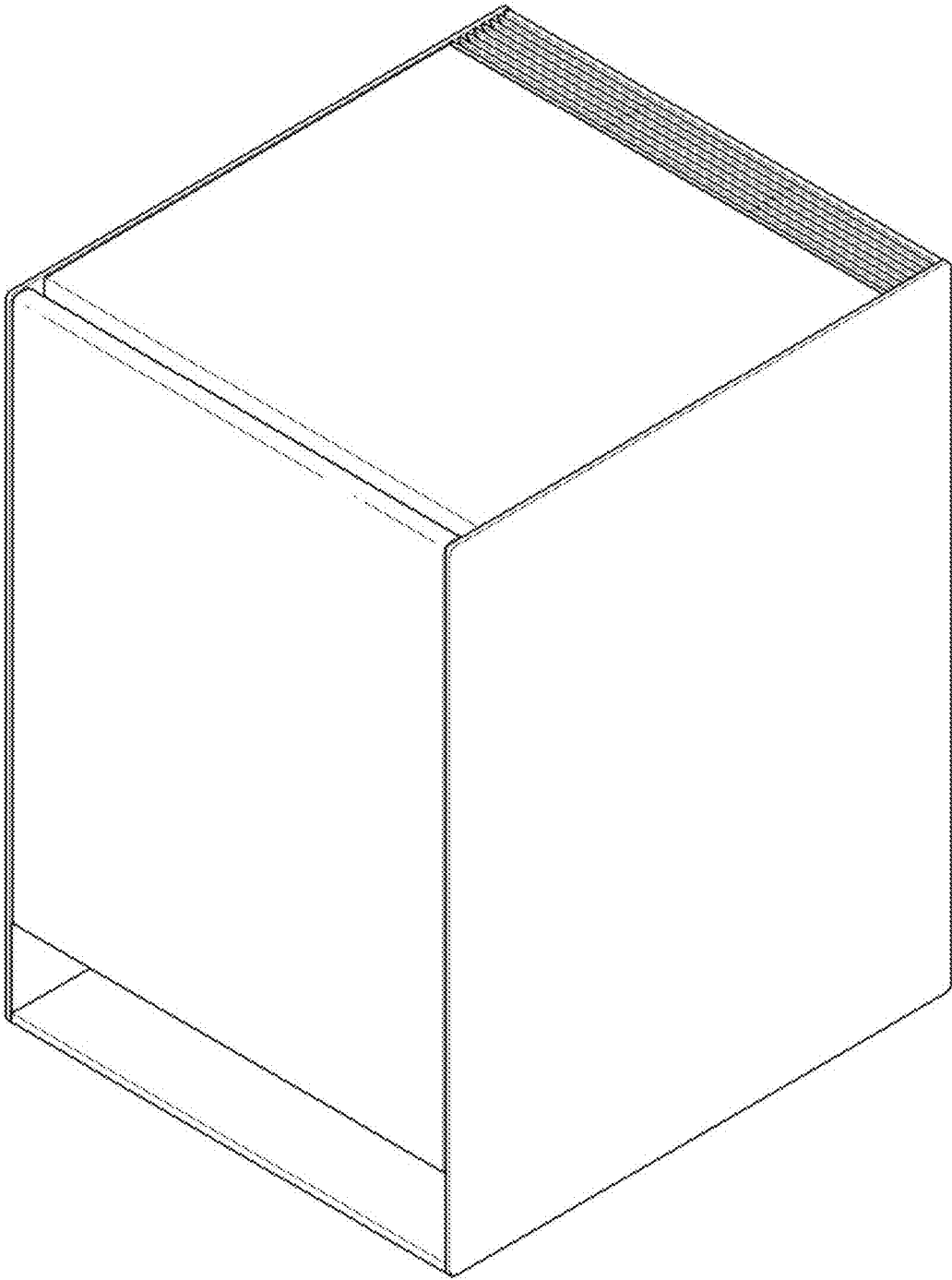

1.2

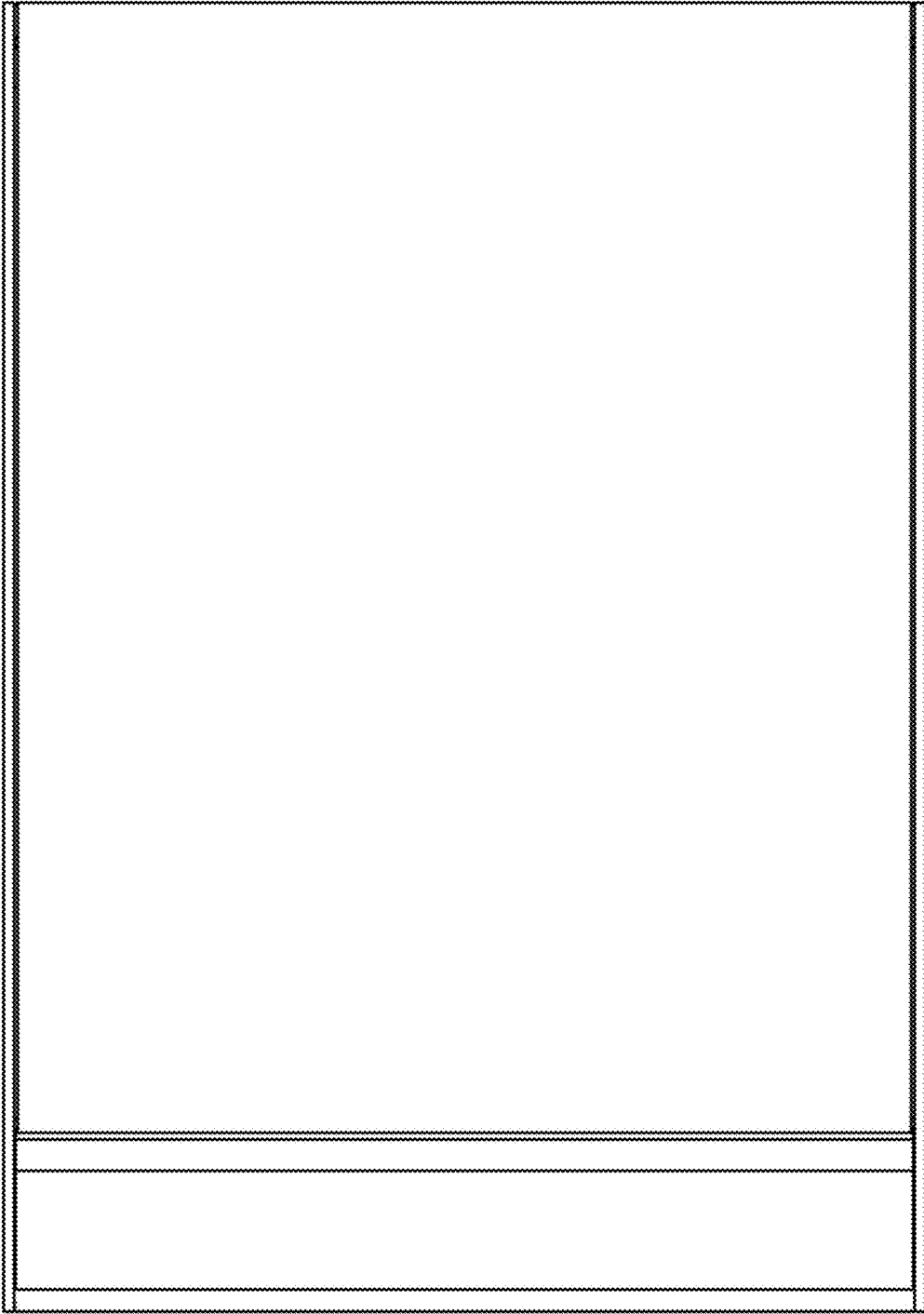

1.3

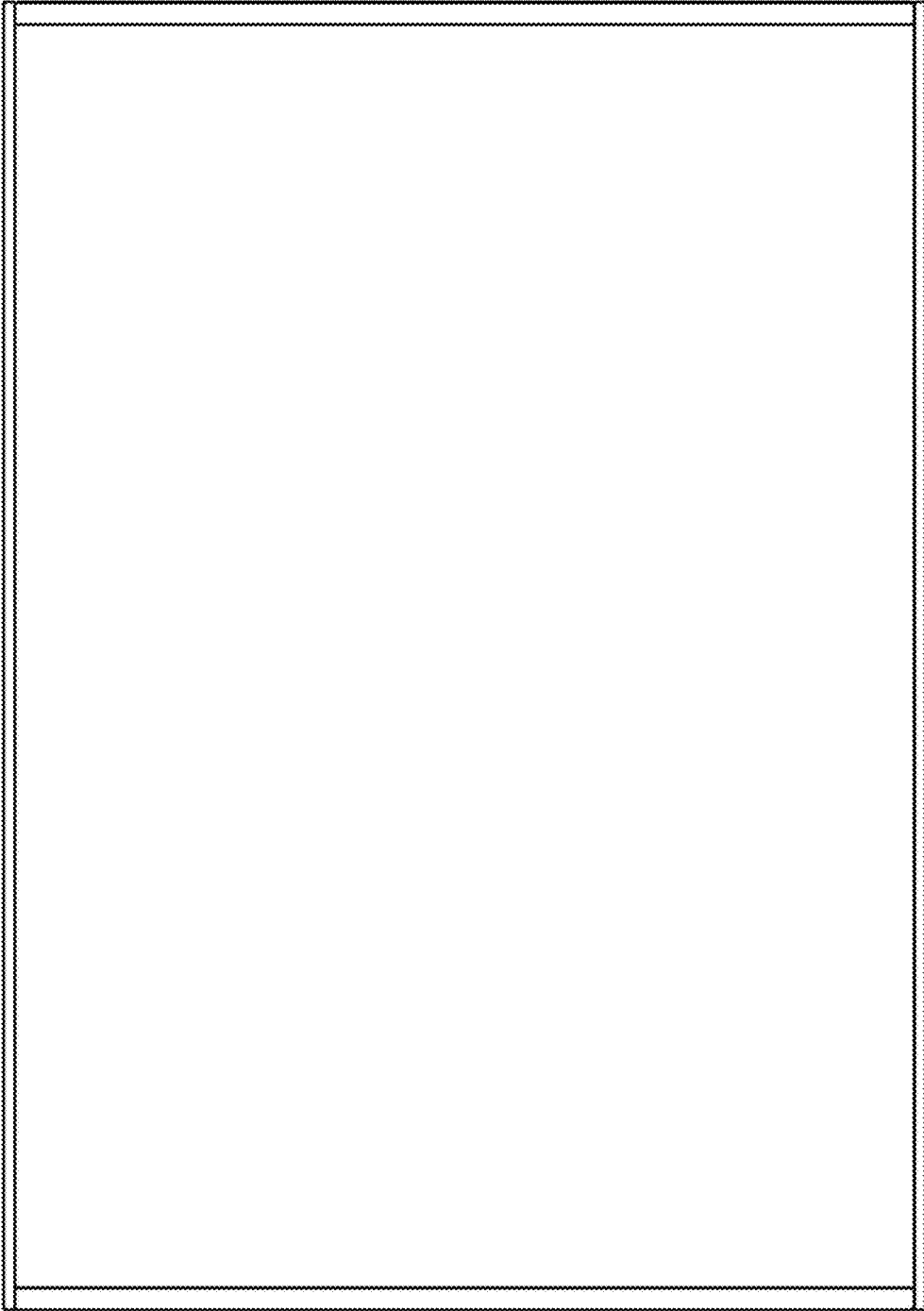

1.4

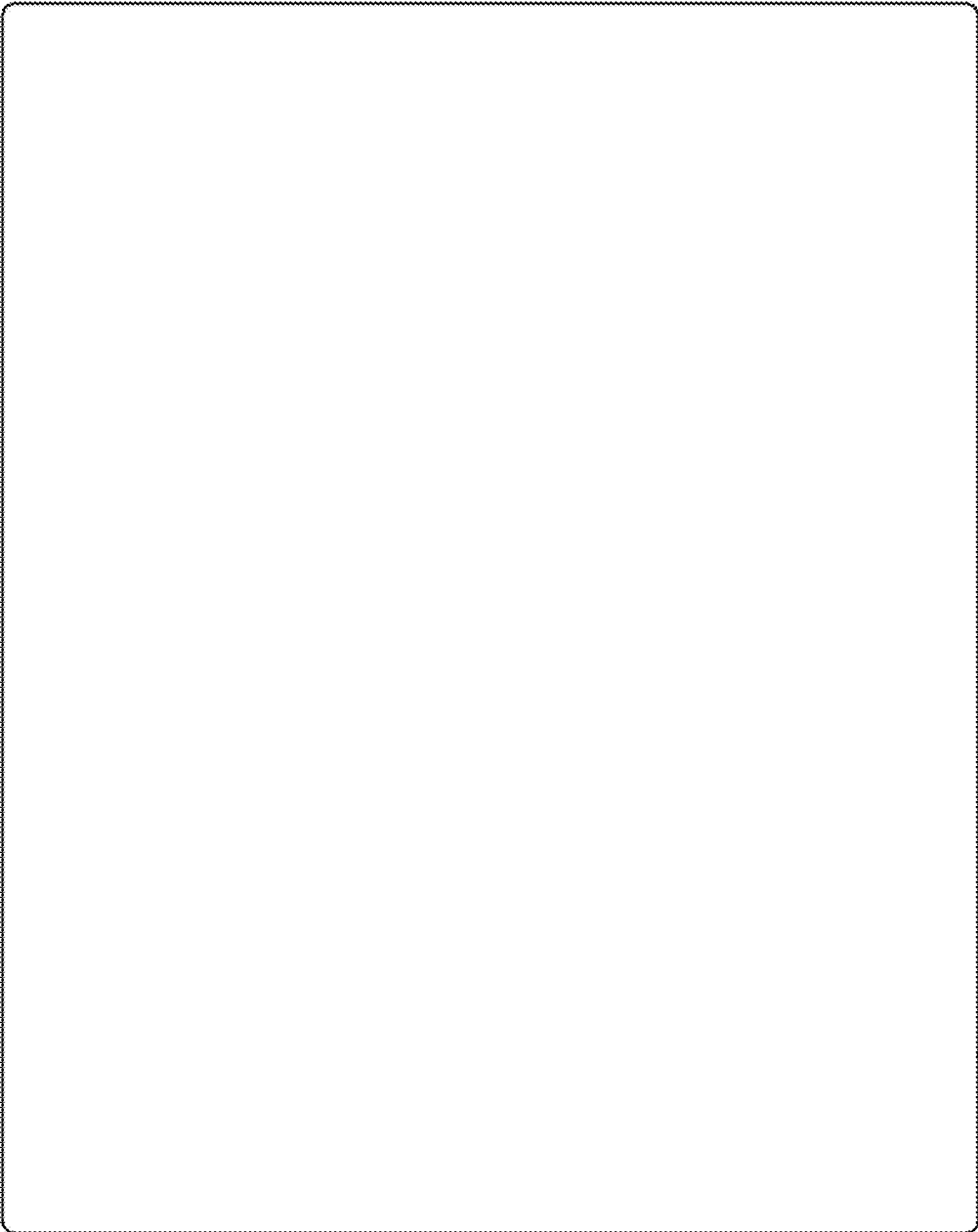

1.5

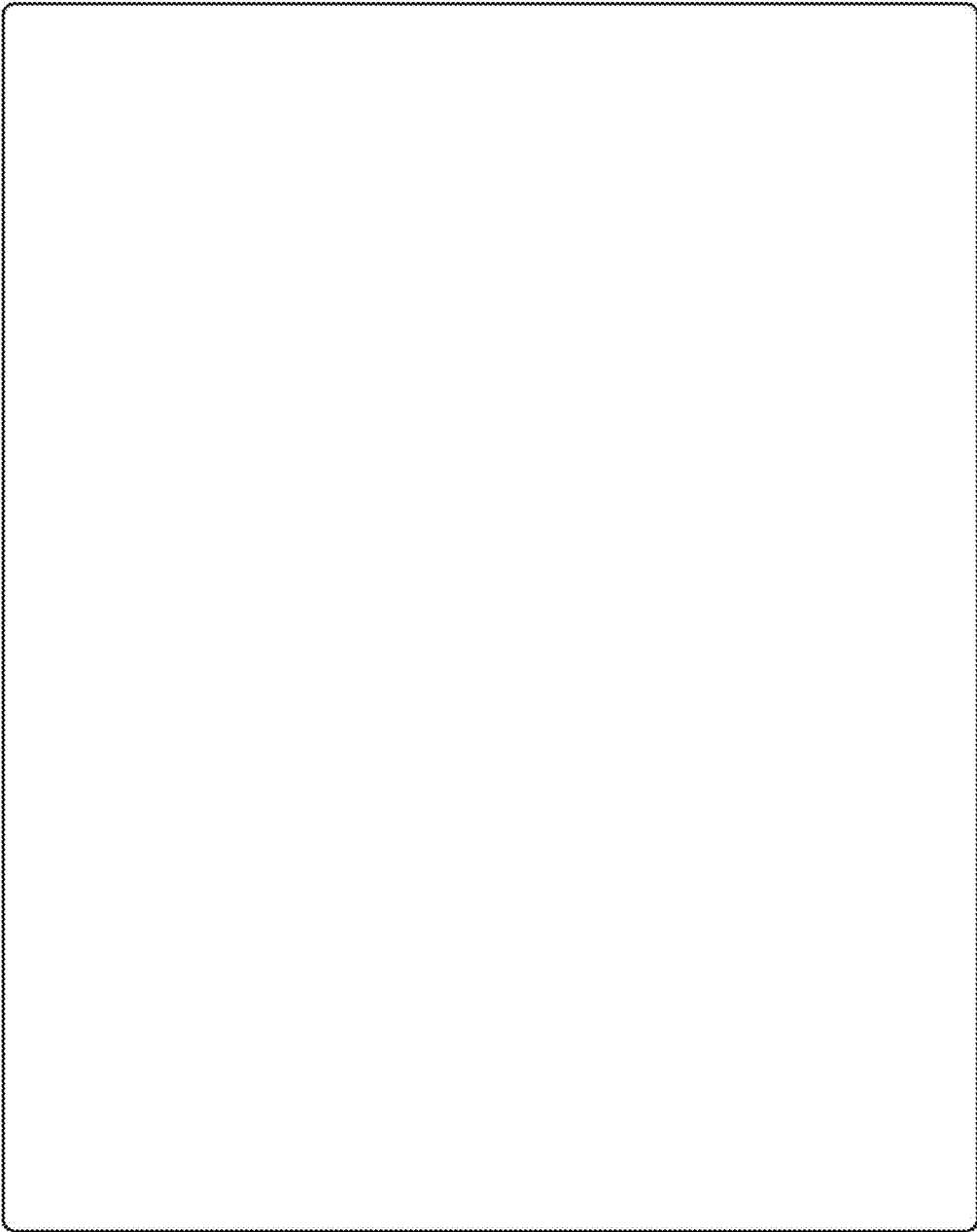

1.6

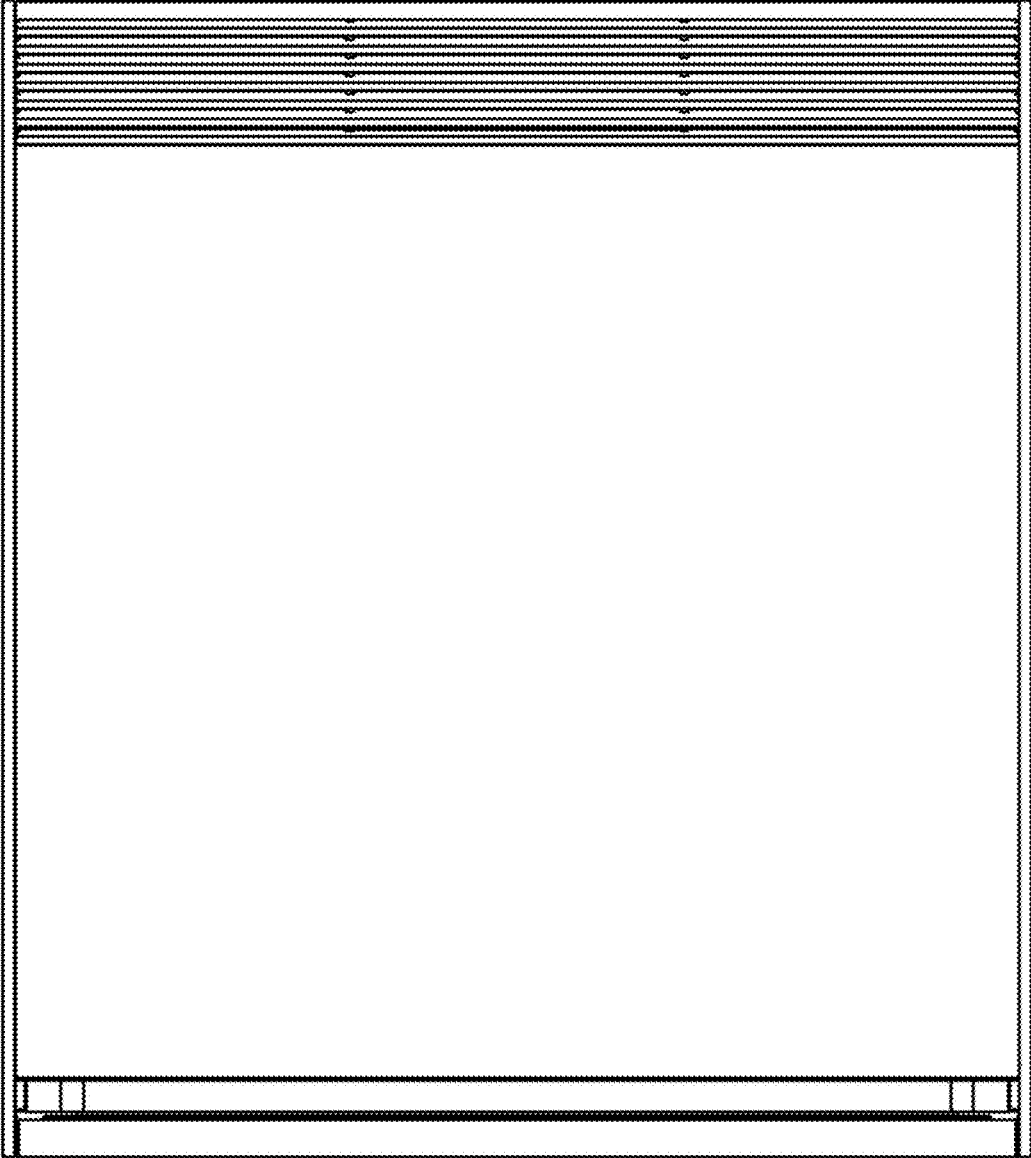

1.7

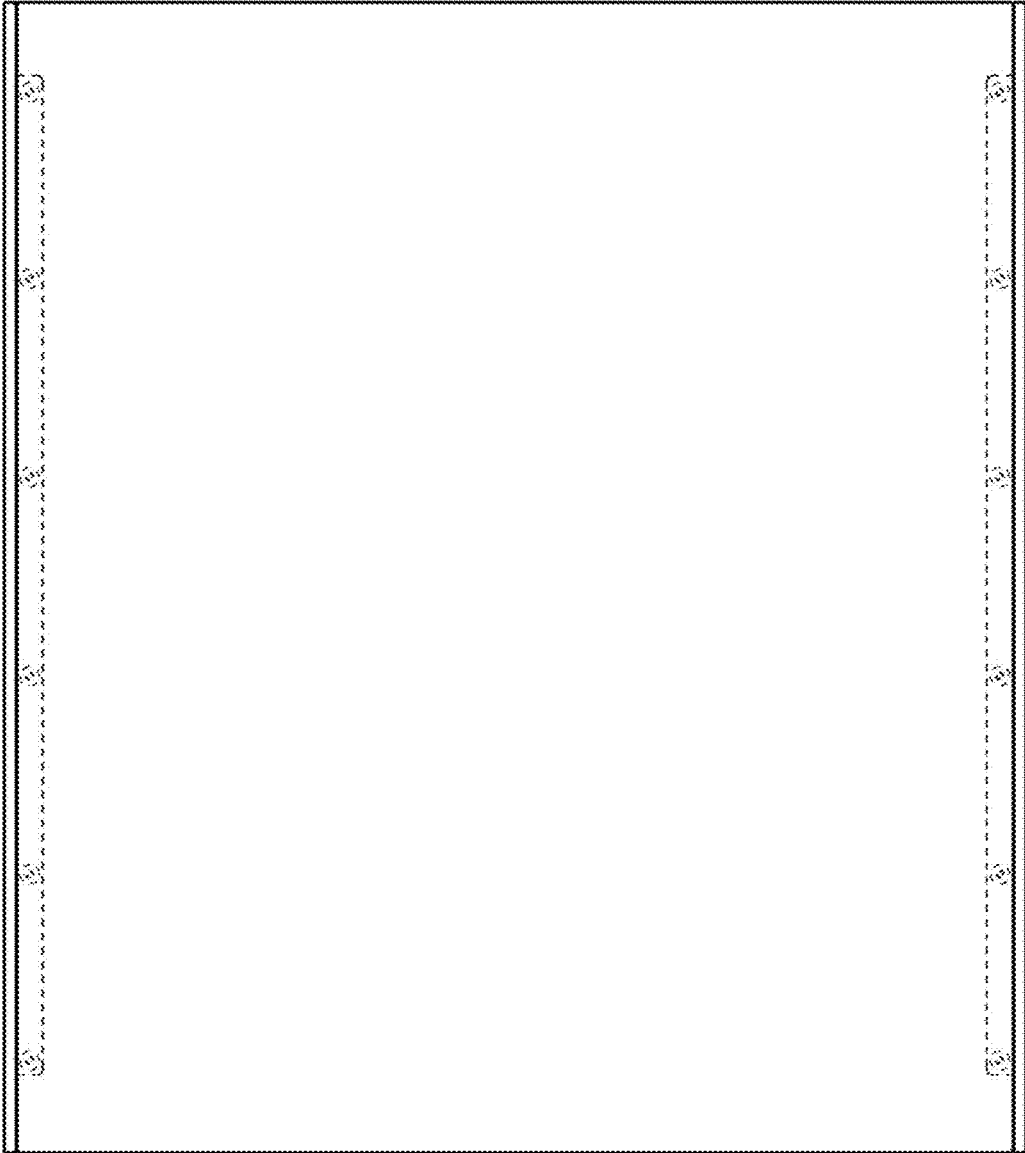

1.8

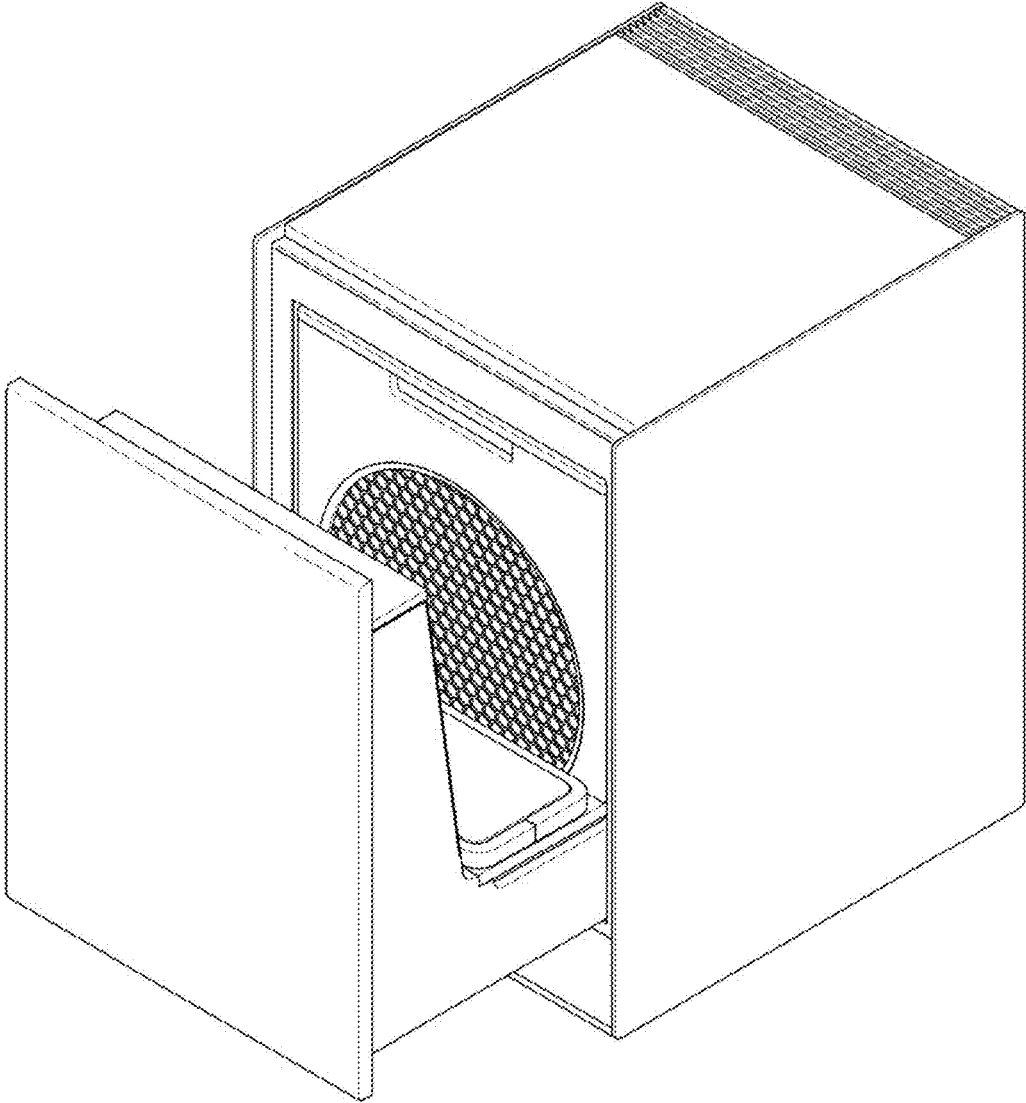

1.9

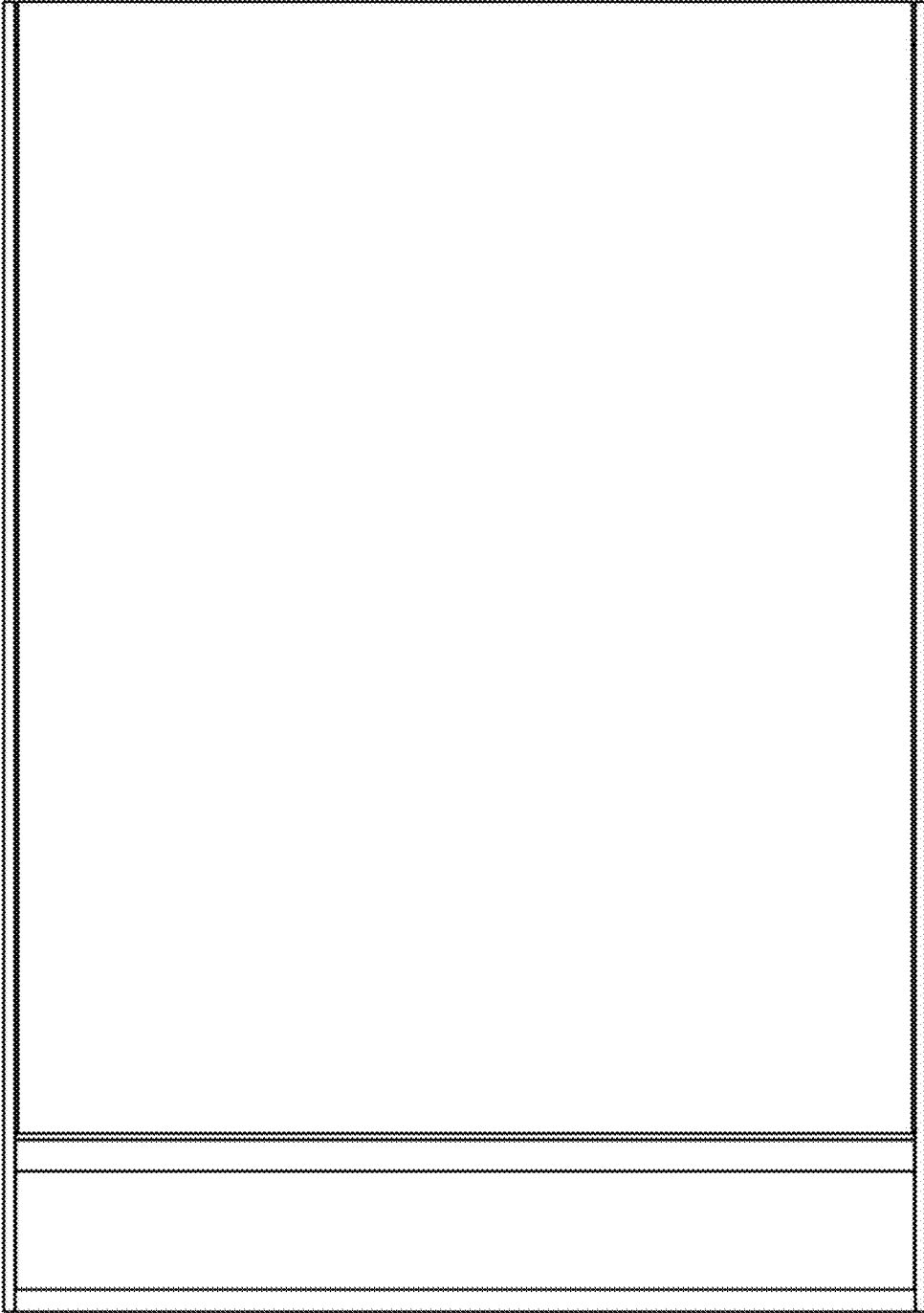

1.10

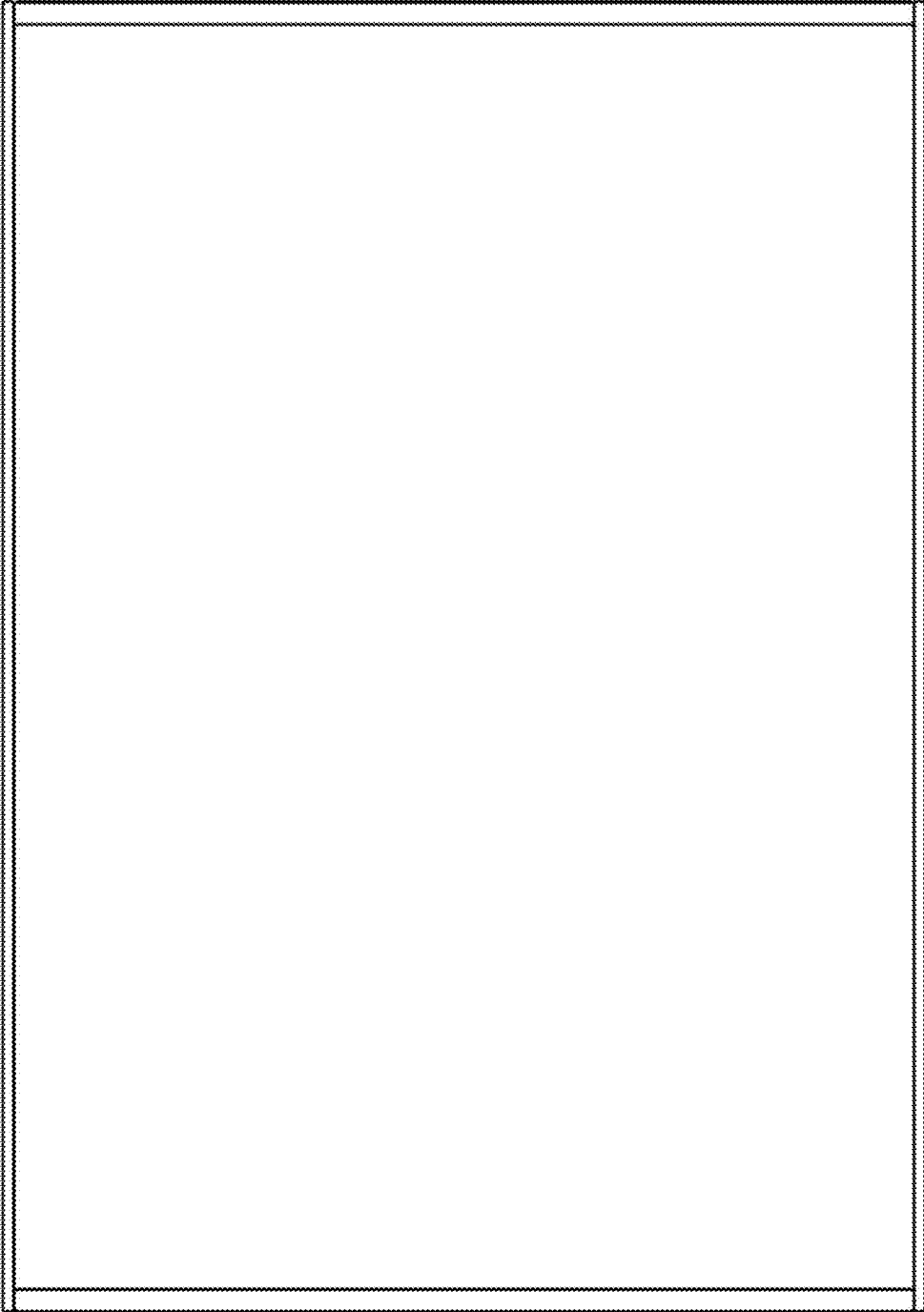

1.11

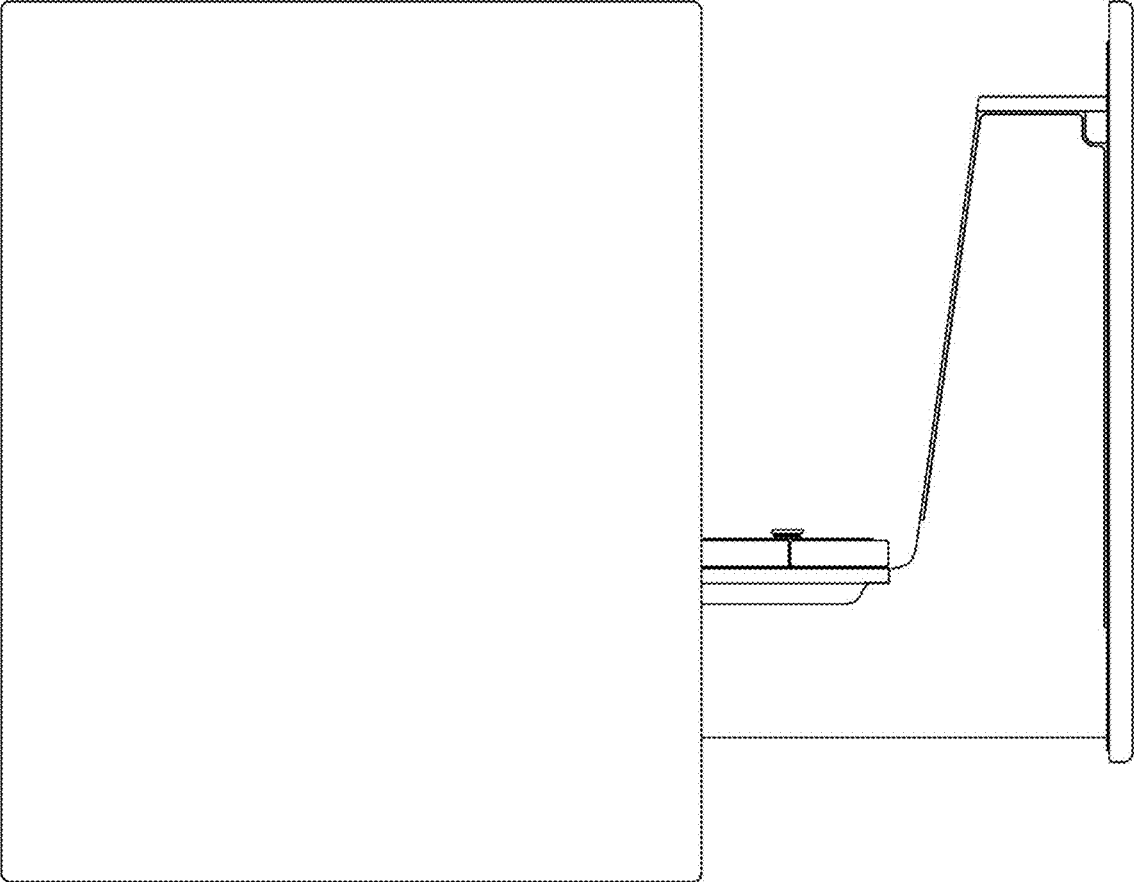

1.12

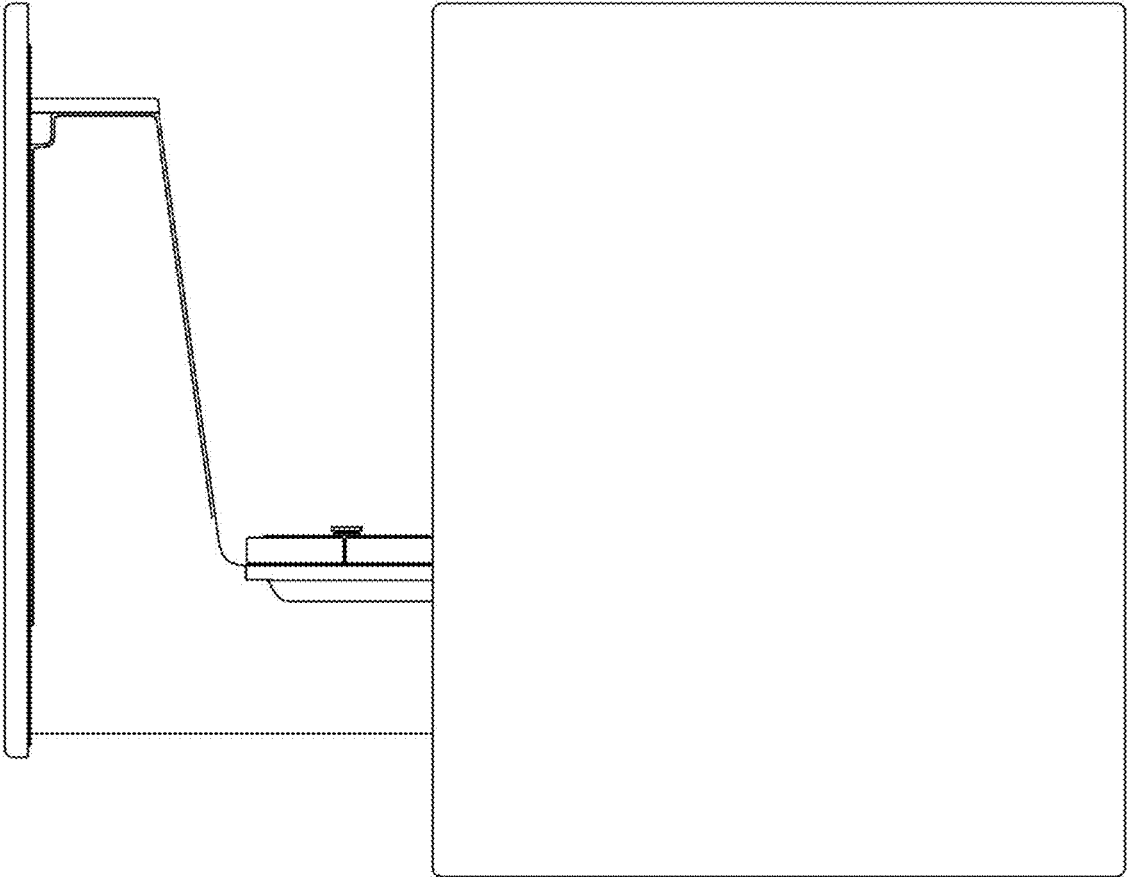

1.13

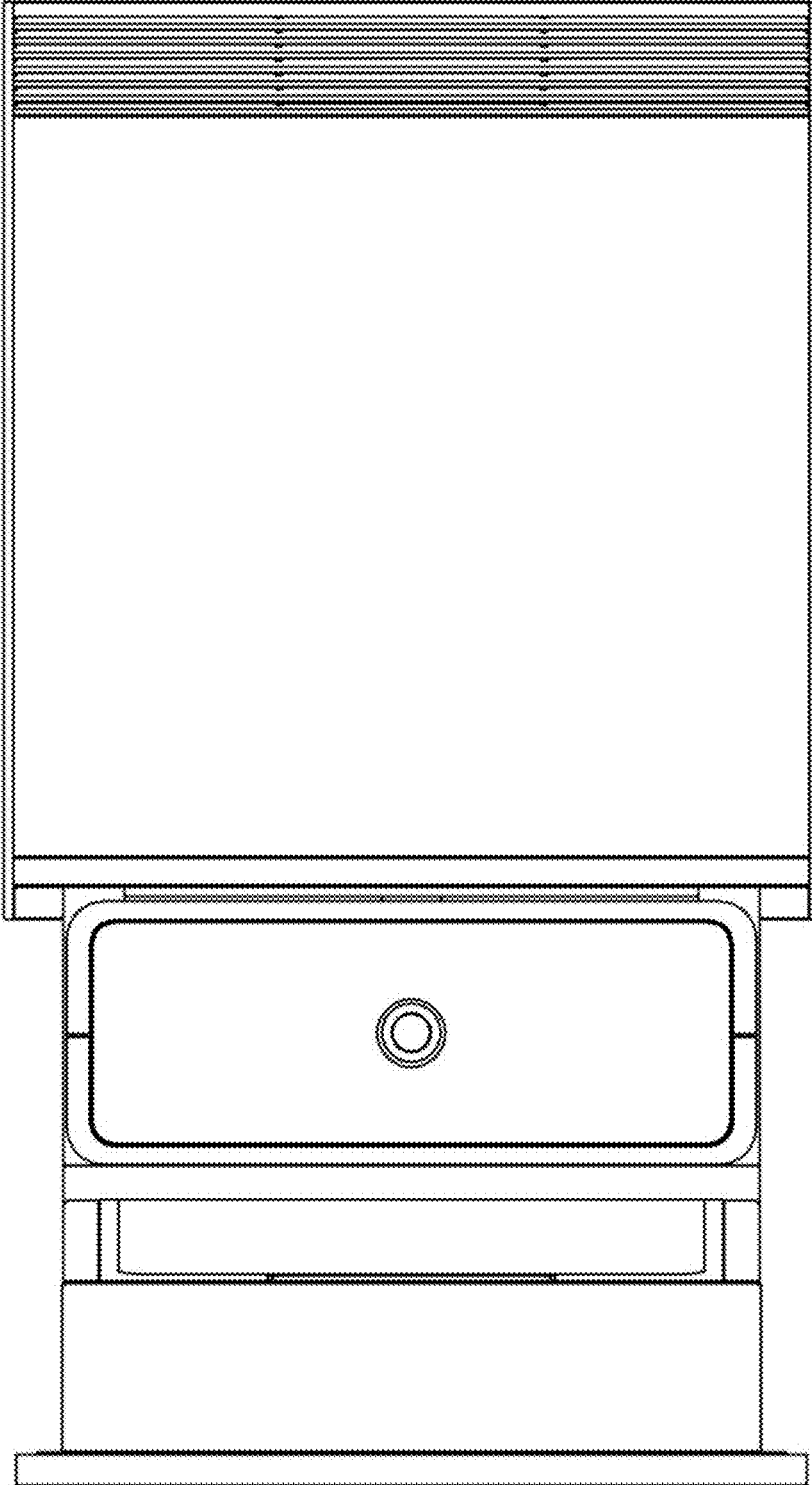

1.14

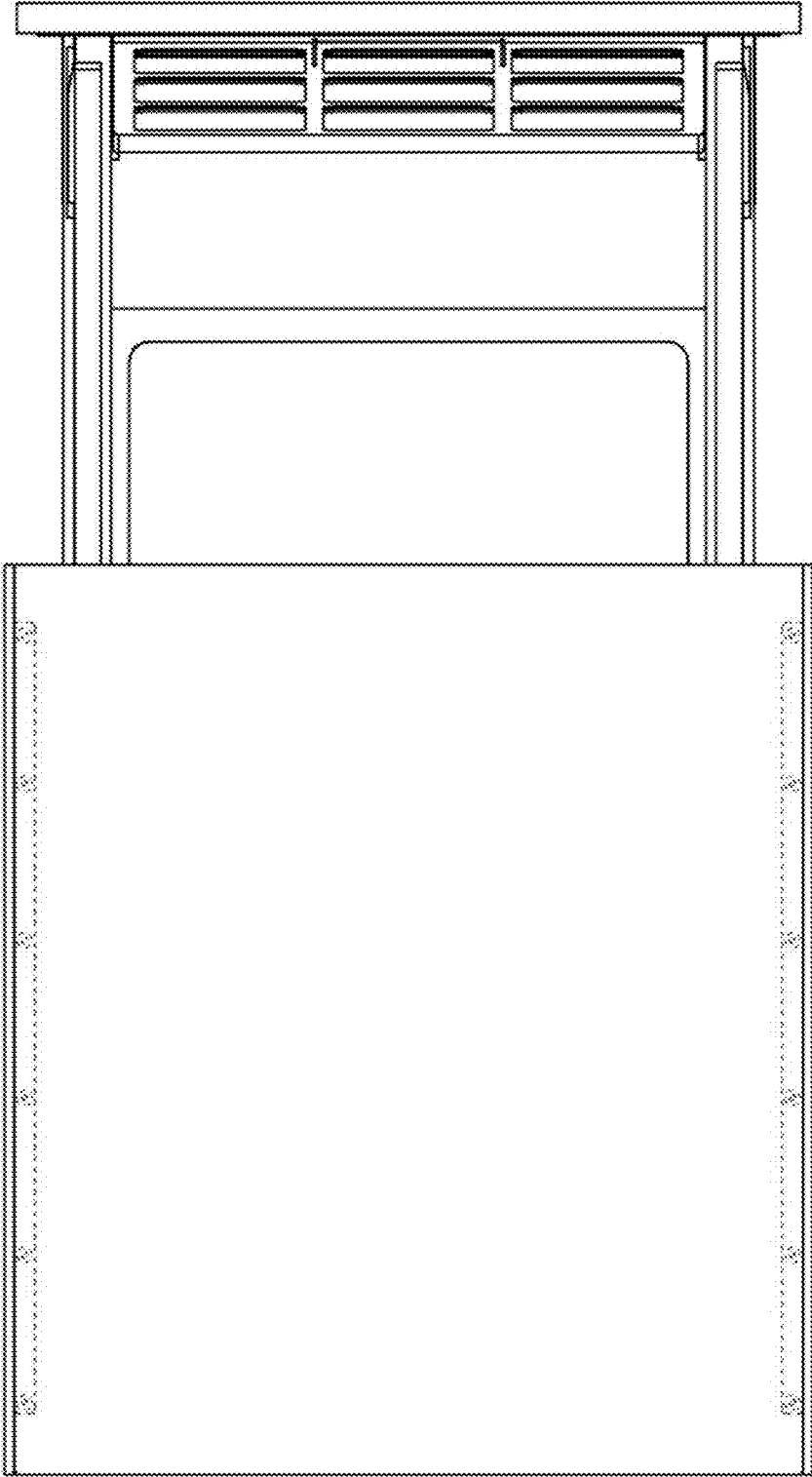

1.15

