



US00D525969S

(12) **United States Design Patent**  
Sugihara et al.

(10) **Patent No.:** **US D525,969 S**

(45) **Date of Patent:** **\*\* Aug. 1, 2006**

(54) **COMPUTER SERVER**

(75) Inventors: **Yuichi Sugihara**, Tokyo (JP);  
**Kenichiro Matsushita**, Tokyo (JP)

(73) Assignee: **NEC Corporation**, Tokyo (JP)

(\*\*) Term: **14 Years**

(21) Appl. No.: **29/234,174**

(22) Filed: **Jul. 13, 2005**

(30) **Foreign Application Priority Data**

Jan. 14, 2005 (JP) ..... 2005-000739

(51) **LOC (8) Cl.** ..... **14-02**

(52) **U.S. Cl.** ..... **D14/301**

(58) **Field of Classification Search** ..... D14/300,  
D14/301, 313, 314, 356-368, 349, 435; D13/162,  
D13/184, 199; 312/223.1-223.3; 360/99.01,  
360/99.12; 369/34.01, 36.01, 680-686, 690-696,  
369/77.2; 720/613

See application file for complete search history.

(56) **References Cited**

**U.S. PATENT DOCUMENTS**

D334,918 S \* 4/1993 Hirose et al. .... D14/368

5,532,994 A \* 7/1996 Inoue et al. .... 720/646  
D389,128 S \* 1/1998 Ito et al. .... D14/368  
D391,957 S \* 3/1998 Ito et al. .... D14/368  
D408,380 S \* 4/1999 Crohas ..... D14/368  
D456,022 S \* 4/2002 Dodson ..... D14/355  
2003/0202447 A1 \* 10/2003 Watanabe et al. .... 369/75.2  
2005/0039199 A1 \* 2/2005 Chiou et al. .... 720/613

\* cited by examiner

*Primary Examiner*—Freda S. Nunn

(74) *Attorney, Agent, or Firm*—Seyfarth Shaw LLP

(57) **CLAIM**

The ornamental design for the computer server, as shown and described.

**DESCRIPTION**

FIG. 1 is a perspective view of the computer server showing our new design with shading to show translucency; FIG. 2 is a front view of the computer server showing our new design; FIG. 3 is a rear view thereof; FIG. 4 is a left side view thereof; FIG. 5 is a right side view thereof; FIG. 6 is a top view thereof; and, FIG. 7 is a bottom view thereof.

**1 Claim, 2 Drawing Sheets**

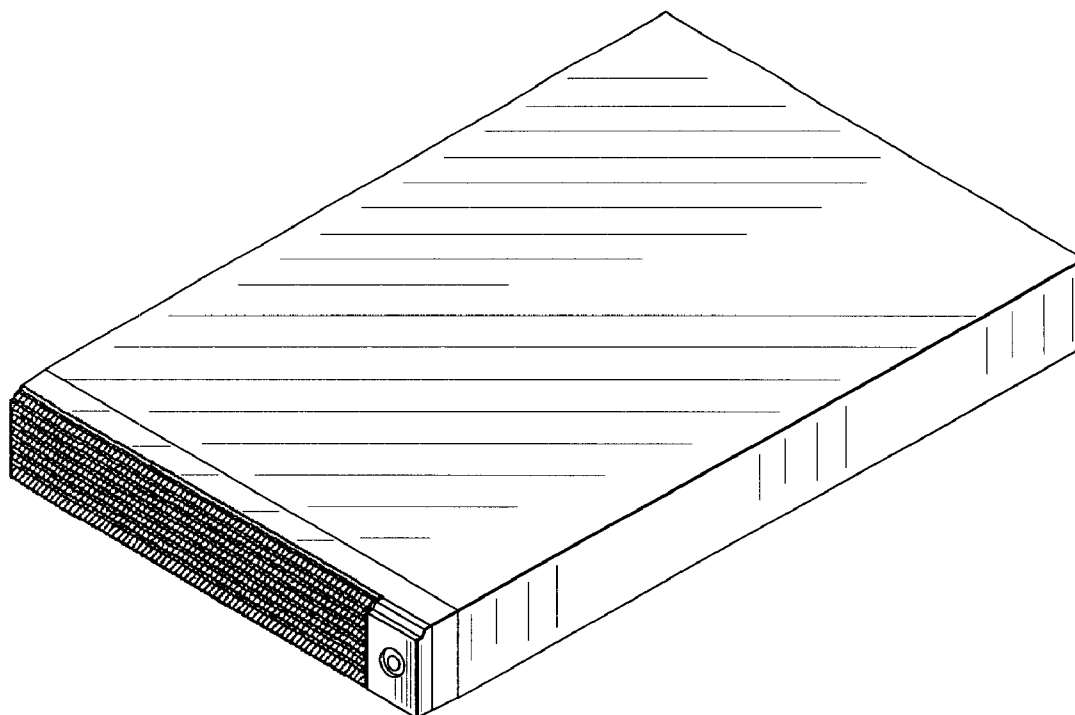

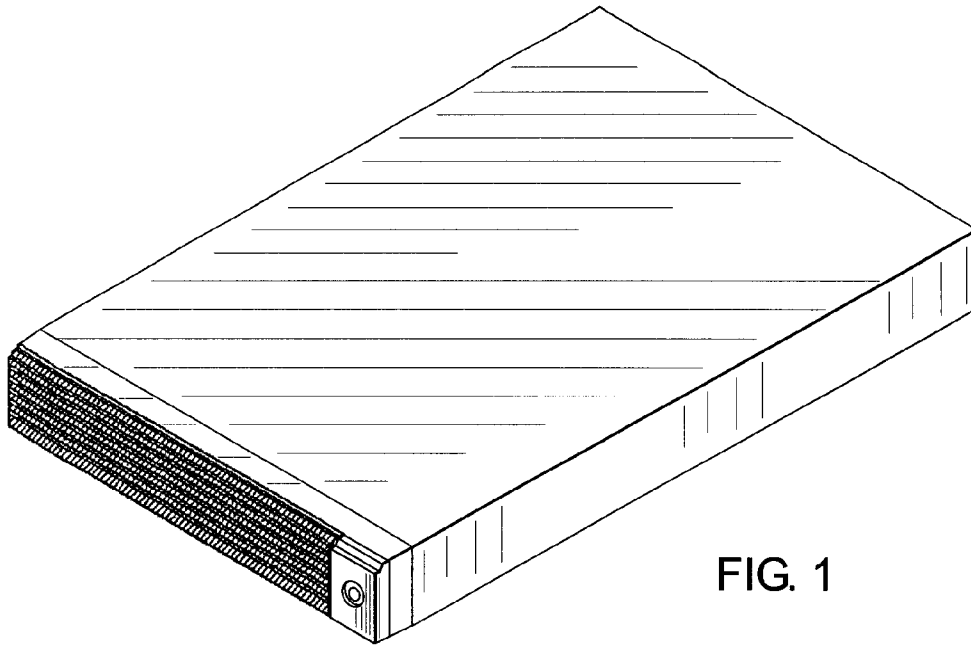

FIG. 1

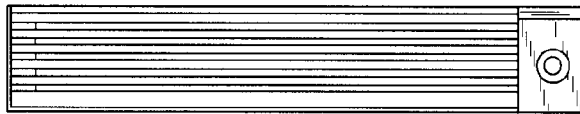

FIG. 2

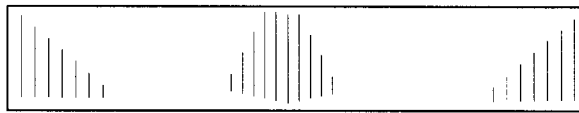

FIG. 3

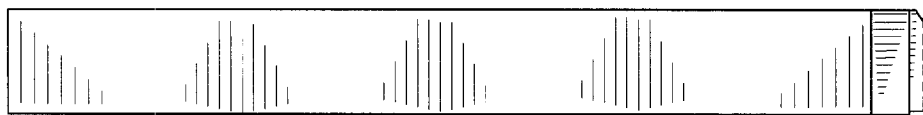

FIG. 4

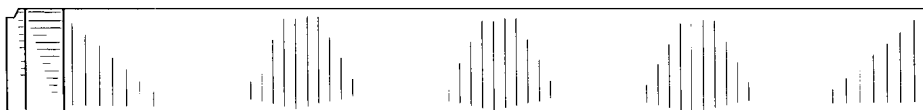

FIG. 5

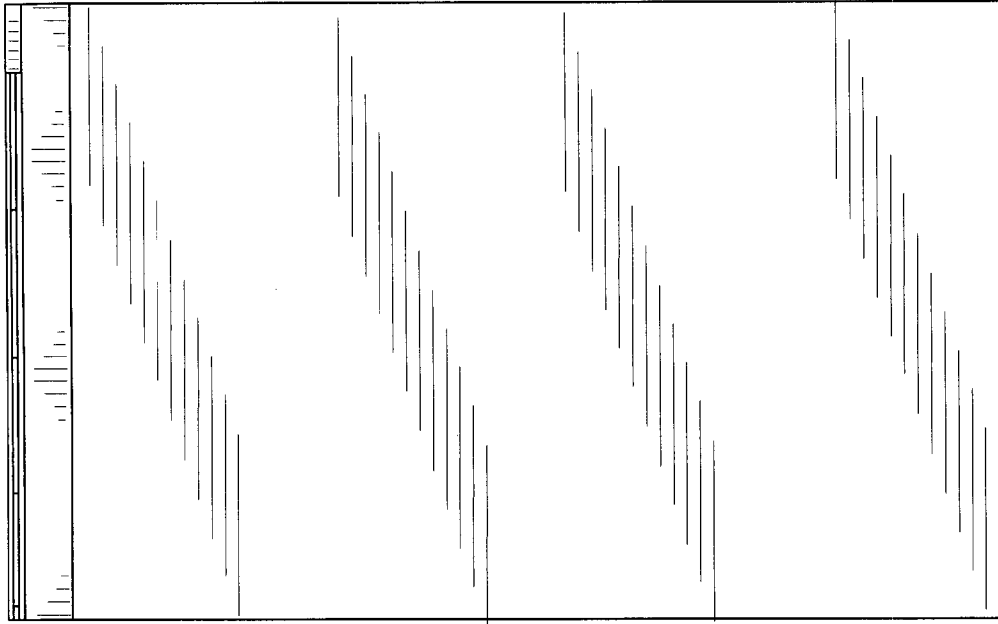

FIG. 7

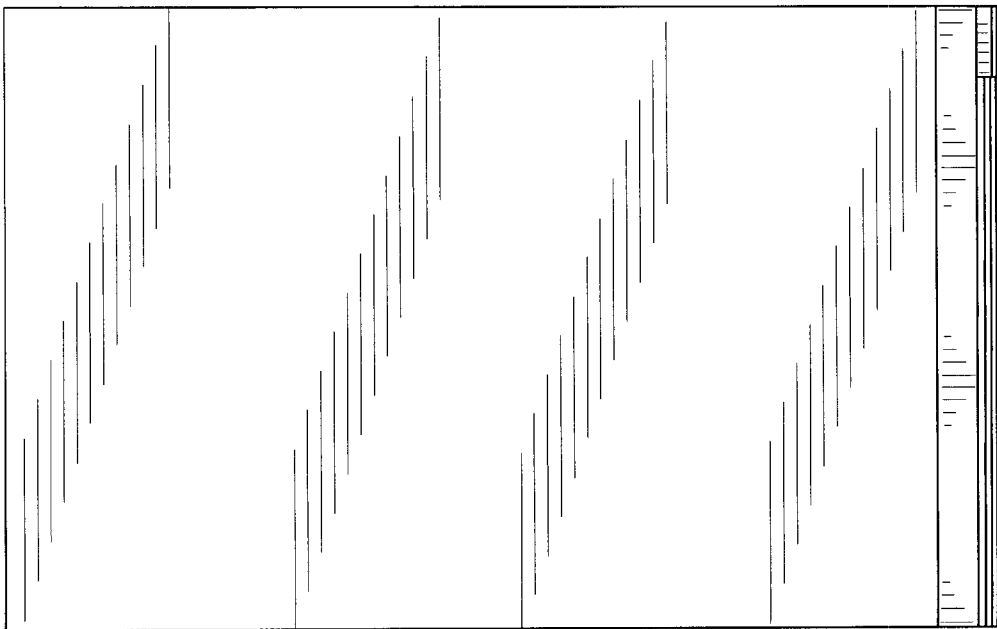

FIG. 6