



US00D990832S

(12) **United States Design Patent**  
**Huang**

(10) **Patent No.:** **US D990,832 S**

(45) **Date of Patent:** **\*\* Jul. 4, 2023**

(54) **BOOT**

(71) Applicant: **Zhicong Huang**, Zhangpu (CN)

(72) Inventor: **Zhicong Huang**, Zhangpu (CN)

(\*\*) Term: **15 Years**

(21) Appl. No.: **29/863,353**

(22) Filed: **Dec. 19, 2022**

(51) **LOC (14) Cl.** ..... **02-04**

(52) **U.S. Cl.**

USPC ..... **D2/909**; D2/910

(58) **Field of Classification Search**

USPC ..... D2/896, 900, 902, 904, 906-909,  
D2/916-924, 925-945, 947-960, 969-979  
CPC .... A43B 1/00; A43B 1/02; A43B 1/04; A43B  
3/00; A43B 3/02; A43B 3/06; A43B 3/10;  
A43B 3/12; A43B 3/14; A43B 5/00;  
A43B 5/001; A43B 5/002; A43B 5/008;  
A43B 5/06; A43B 5/10; A43B 5/12;  
A43B 23/00; A43B 23/02; A43B 23/04;  
A43B 23/14; A43B 23/16; A43B 23/17;  
A43B 23/24; A43B 23/25; A43B 23/26;  
A43C 1/00; A43C 5/00; A43C 7/00;  
A43C 9/00; A43C 11/00

See application file for complete search history.

(56) **References Cited**

**U.S. PATENT DOCUMENTS**

D331,826	S	*	12/1992	Challant	.....	D2/912
D356,664	S	*	3/1995	Cesaretti	.....	D2/912
D398,438	S	*	9/1998	De Baere	.....	D2/912
D447,322	S	*	9/2001	Auberry	.....	D2/912
D467,057	S	*	12/2002	Jacobs	.....	D2/902
D647,288	S	*	10/2011	Carpenter	.....	D2/912
D661,472	S	*	6/2012	Ghedin	.....	D2/912
D670,072	S	*	11/2012	Debellis	.....	
D680,714	S	*	4/2013	Della Valle	.....	D2/908
D688,035	S	*	8/2013	Recchi	.....	D2/951

D699,419	S	*	2/2014	Horn	.....	D2/899
D703,420	S	*	4/2014	Truelsen	.....	D2/912
D730,037	S	*	5/2015	Spring	.....	D2/970
D732,805	S	*	6/2015	Bruder	.....	D2/911
D738,079	S	*	9/2015	Bates	.....	D2/951
D746,029	S	*	12/2015	Hardy	.....	D2/943
D759,948	S	*	6/2016	Sassi	.....	D2/944
D781,541	S	*	3/2017	McGhee	.....	D2/947
D782,165	S	*	3/2017	Slimane	.....	D2/944
D793,676	S	*	8/2017	Slimane	.....	D2/944
D799,170	S	*	10/2017	Foust	.....	D2/910

(Continued)

**OTHER PUBLICATIONS**

Thorogood American Heritage 8" Steel Toe Work Boots for Men, Amazon.com, Date First Available: Mar. 20, 2009, [online], [site visited Jan. 17, 2023]. <URL: <https://www.amazon.com/Thorogood-American-Toe-Safety-Boot/dp/B002QXL6JS>> (Year: 2009).\*

(Continued)

*Primary Examiner* — Jonathan J Han

(74) *Attorney, Agent, or Firm* — Jose Cherson Weissbrot

(57)

**CLAIM**

The ornamental design for a boot, as shown and described.

**DESCRIPTION**

FIG. 1 is a first perspective view of a boot showing my new design;

FIG. 2 is a second perspective view thereof;

FIG. 3 is a top view thereof;

FIG. 4 is a bottom view thereof;

FIG. 5 is a left side view thereof;

FIG. 6 is a right side view thereof;

FIG. 7 is a back view thereof; and,

FIG. 8 is a front view thereof.

The broken lines shown in the drawings depict portions of the boot that form no part of the claimed design.

**1 Claim, 8 Drawing Sheets**

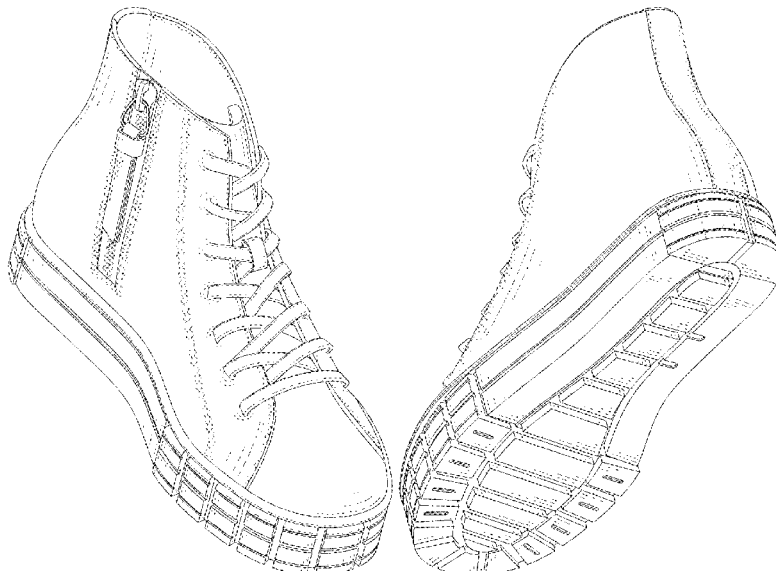

(56)

**References Cited**

## U.S. PATENT DOCUMENTS

D838,445	S	*	1/2019	Kains	.....	D2/912
D838,458	S	*	1/2019	Ledbetter	.....	D2/912
D843,098	S	*	3/2019	Natowich McPhee	.....	D2/947
D850,065	S		6/2019	Isaack		
D850,067	S	*	6/2019	Nakamura	.....	D2/947
D851,868	S		6/2019	Isaack		
D861,308	S	*	10/2019	Chang	.....	D2/947
D862,060	S	*	10/2019	Weeks	.....	D2/951
D886,419	S	*	6/2020	McGhee	.....	D2/912
D886,424	S	*	6/2020	McKenzie	.....	D2/947
D887,682	S	*	6/2020	Sogorb	.....	D2/902
D887,688	S	*	6/2020	McKenzie	.....	D2/947
D889,787	S	*	7/2020	McKenzie	.....	D2/947
D925,883	S	*	7/2021	Mokos	.....	D2/947
D943,247	S	*	2/2022	Patillon	.....	D2/943
D949,527	S	*	4/2022	Heftman	.....	D2/944
D953,706	S	*	6/2022	Wu	.....	D2/900
D961,209	S	*	8/2022	Venturini Fendi	.....	D2/947

## OTHER PUBLICATIONS

Women's Kolbi Combat Boots—Universal Thread, Target.com, [online], [site visited Jan. 17, 2023]. <URL: <https://www.target.com/p/women-s-kolbi-combat-boots-universal-thread/-/A-85414138>> (Year: 2023).\*

\* cited by examiner



FIG. 1

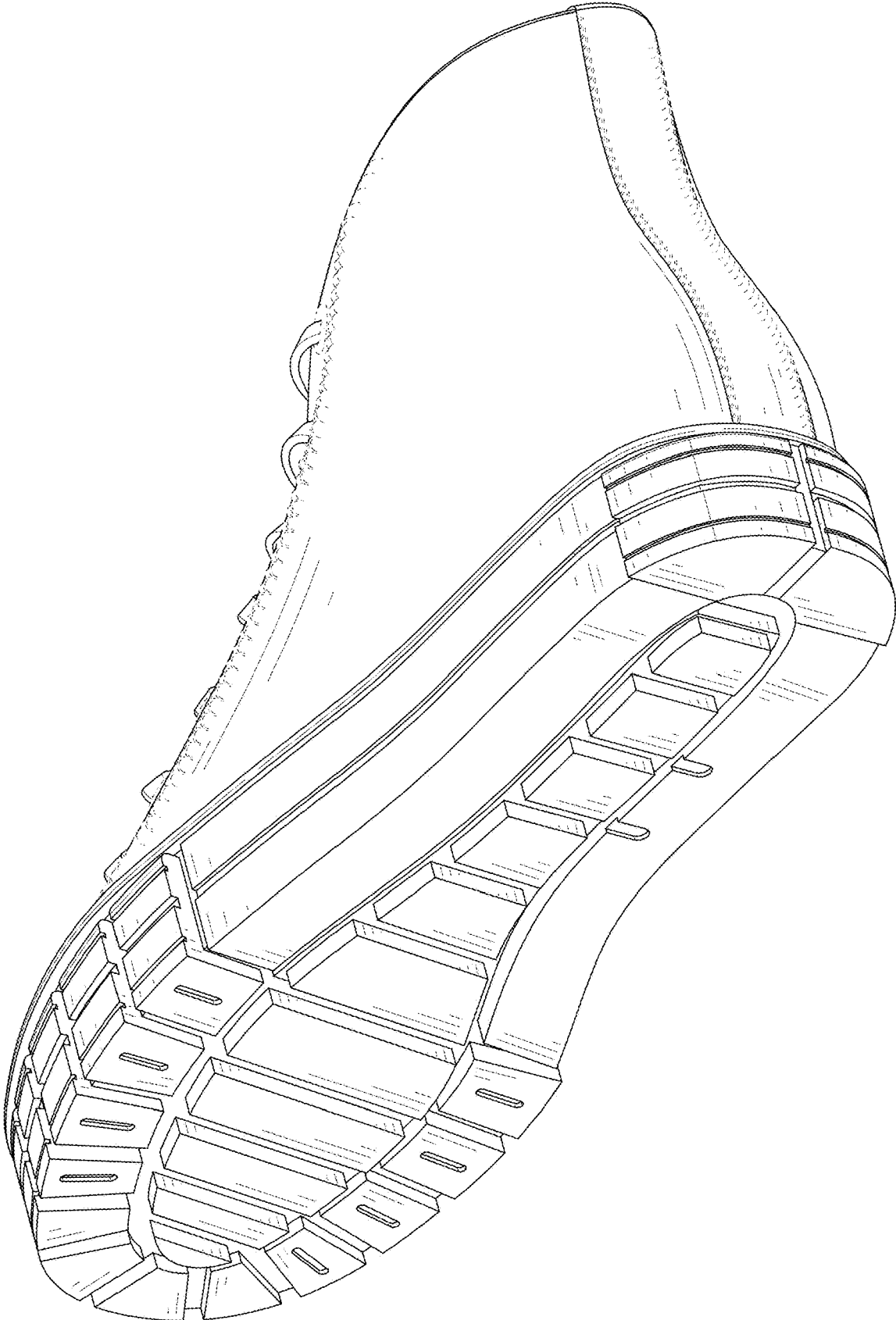

FIG. 2

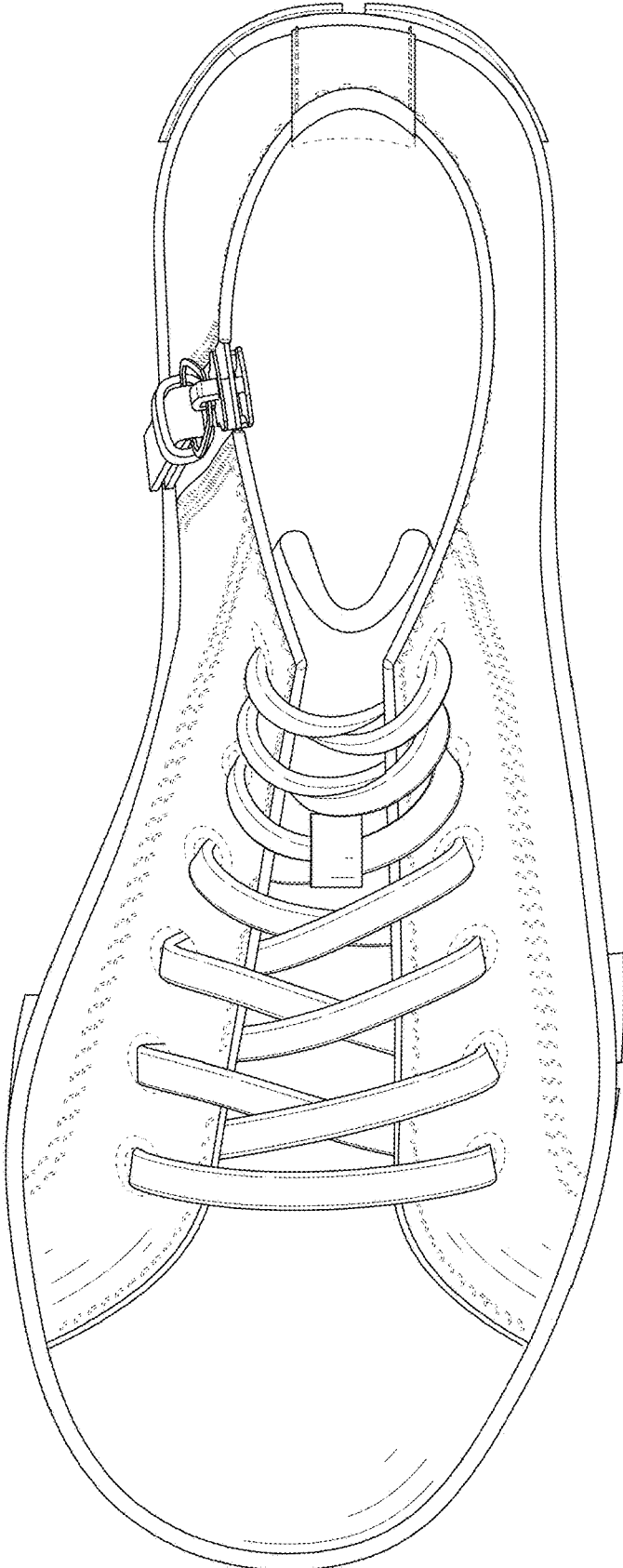

FIG. 3

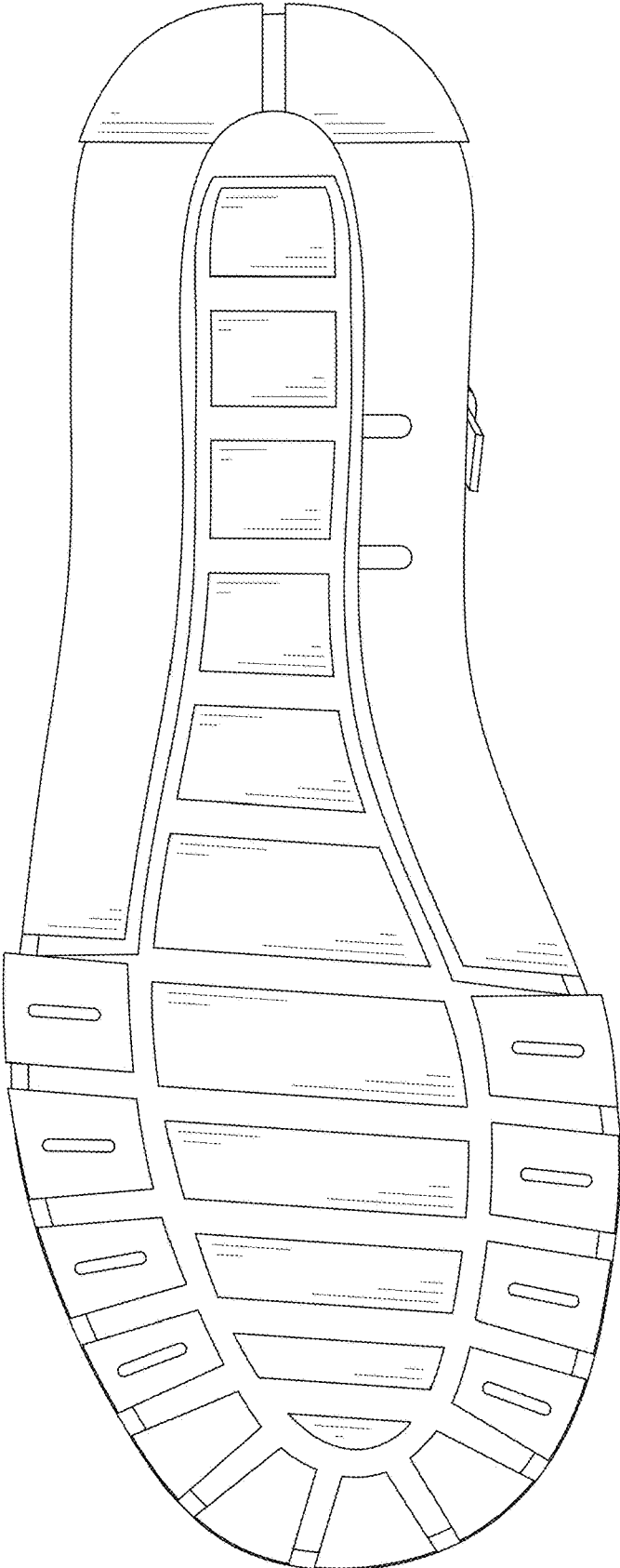

FIG. 4

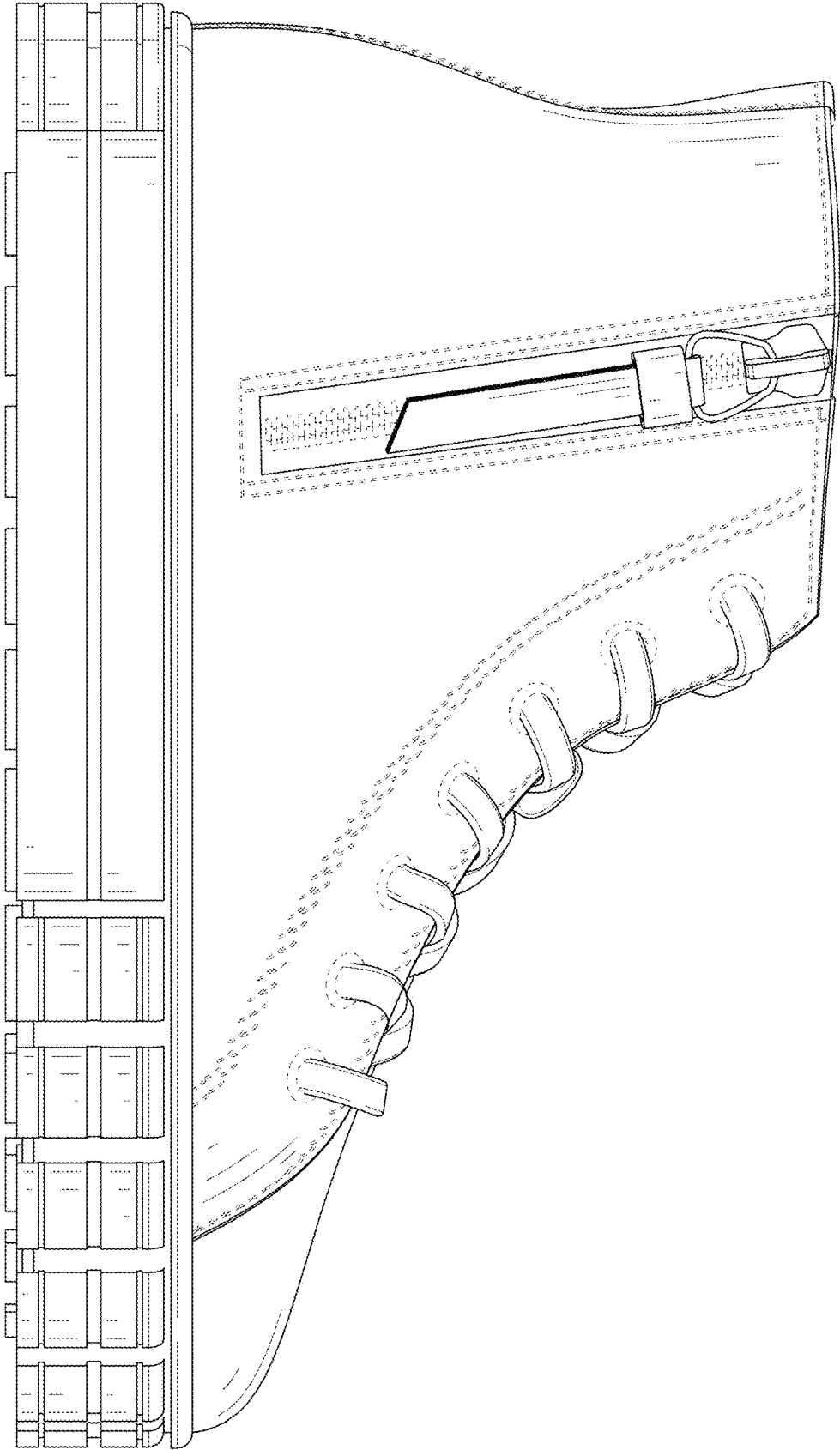

FIG. 5

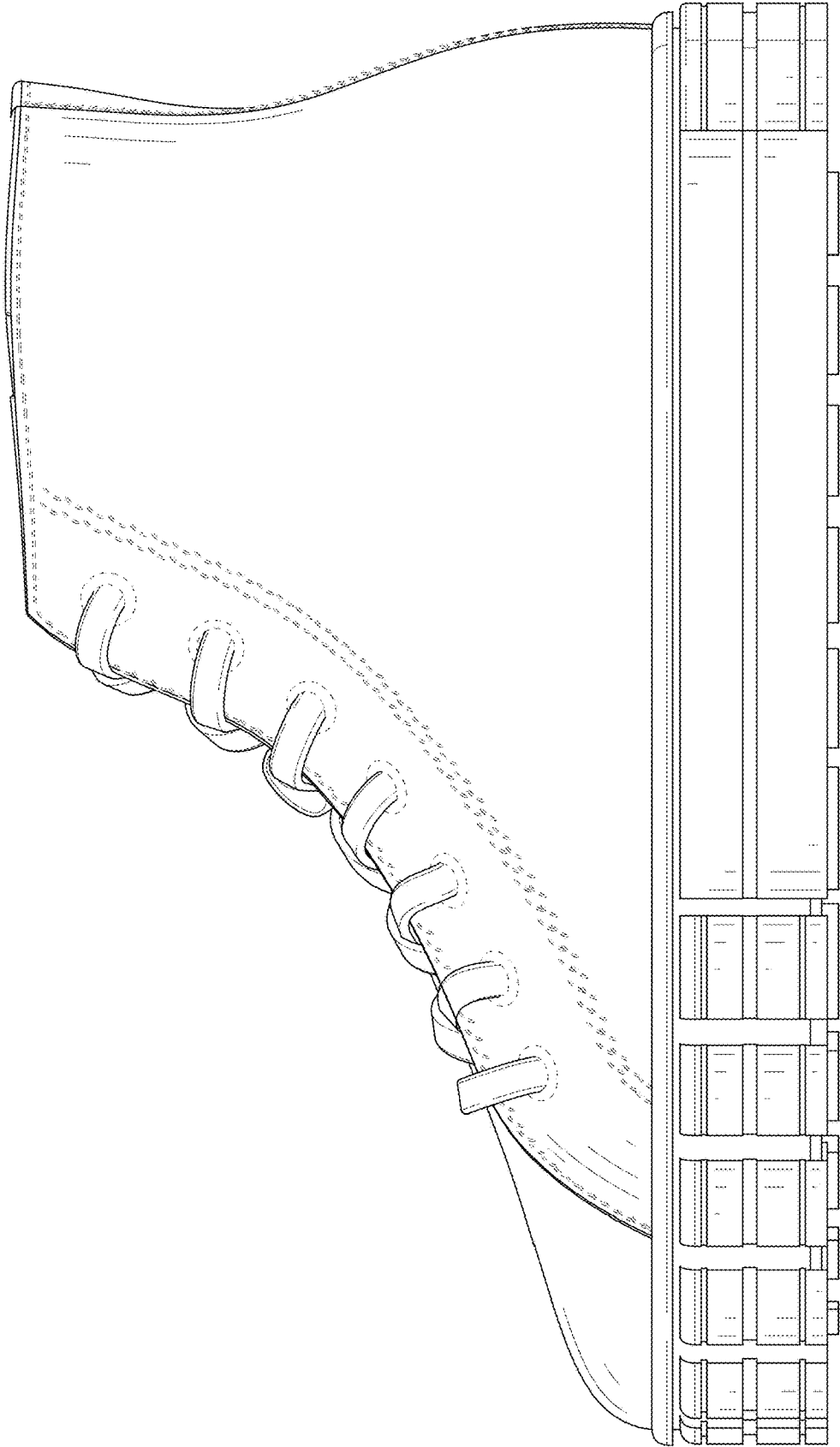

FIG. 6

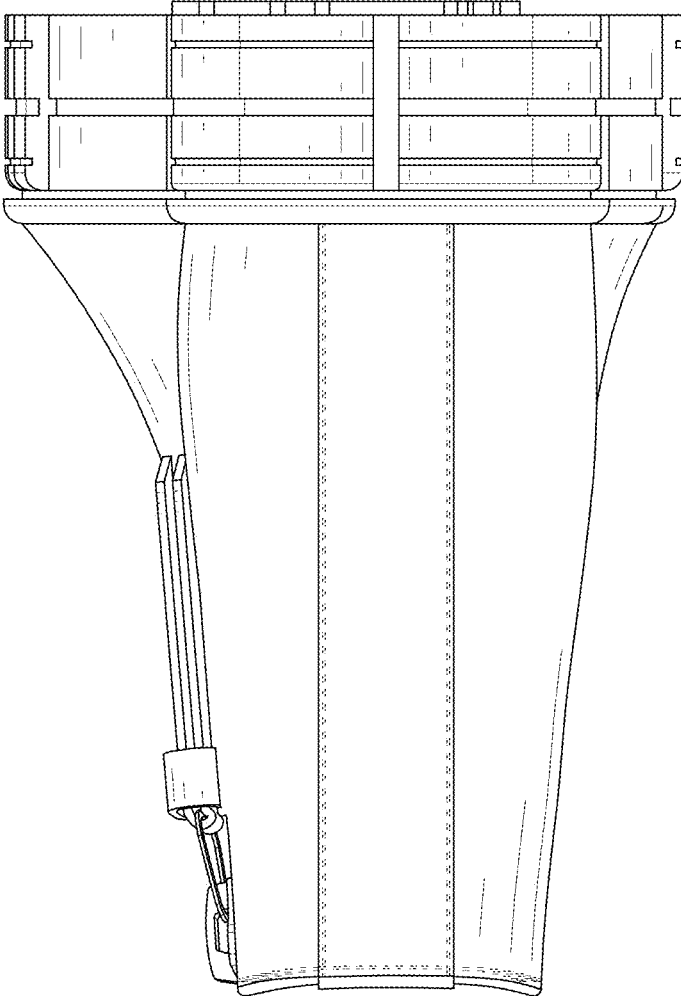

FIG. 7

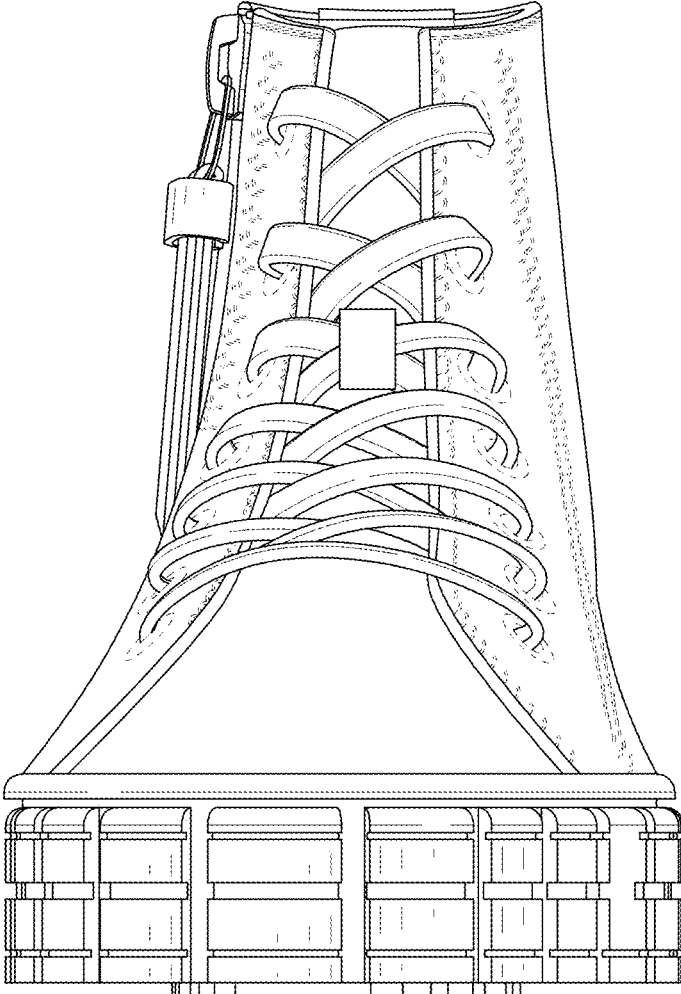

FIG. 8