

United States Patent [19]
Sakanishi et al.

[11] **Patent Number:** **Des. 366,281**
 [45] **Date of Patent:** ****Jan. 16, 1996**

[54] **TRANSFER TAPE HOLDER**
 [75] Inventors: **Yutaka Sakanishi; Kiyofumi Hayashi,**
 both of Osaka, Japan
 [73] Assignee: **Fuji Copian Co., Ltd.,** Osaka, Japan
 [**] Term: **14 Years**

[21] Appl. No.: **15,463**
 [22] Filed: **Nov. 17, 1993**

[30] **Foreign Application Priority Data**
 May 21, 1993 [JP] Japan 5-14733
 [52] **U.S. Cl.** **D19/69; D19/67**
 [58] **Field of Search** **D19/65, 67, 68,**
D19/69, 95, 99, 100; 225/6, 7, 12, 19, 25,
34-37, 45, 54, 56, 65, 77, 89; 242/84.8,
173; 156/510, 523, 527, 384

[56] **References Cited**

U.S. PATENT DOCUMENTS

D. 238,360	1/1976	Gibbs	D19/69
D. 298,440	11/1988	Kida	D19/69
D. 310,687	9/1990	Berracasa	D19/69
D. 328,312	7/1992	Halm	D19/69
D. 328,471	8/1992	Halm	D19/67 X
D. 329,463	9/1992	Halm	D19/67 X
2,582,979	1/1952	Fritzinger	D19/69 X
2,582,980	1/1952	Fritzinger	D19/69 X

FOREIGN PATENT DOCUMENTS

611384	7/1926	France	401/88
--------	--------	--------	-------	--------

Primary Examiner—Martie Thompson
Attorney, Agent, or Firm—Jordan and Hamburg

[57] **CLAIM**

The ornamental design for a transfer tape holder, as shown and described.

DESCRIPTION

FIG. 1 is a plan view of a transfer tape holder showing our

new design;
 FIG. 2 is a front view thereof;
 FIG. 3 is a bottom view thereof;
 FIG. 4 is a left side view thereof;
 FIG. 5 is a right side view thereof;
 FIG. 6 is a rear view thereof;
 FIG. 7 is a view showing the opened holder with the cover (or cap) member removed for convenience of illustration;
 FIG. 8 is a perspective view of FIG. 1;
 FIG. 9 is a plan view of the holder body with the cover (or cap) member removed for convenience of illustration;
 FIG. 10 is a front view of the holder body with the cover (or cap) member removed for convenience of illustration;
 FIG. 11 is a bottom view of the holder body with the cover (or cap) member removed for convenience of illustration;
 FIG. 12 is a rear view of the holder body with the cover (or cap) member removed for convenience of illustration;
 FIG. 13 is a left side view of the holder body with the cover (or cap) member removed for convenience of illustration;
 FIG. 14 is a right side view of the holder body with the cover (or cap) member removed for convenience of illustration;
 FIG. 15 is a front view of the cover (or cap) member with the holder body removed for convenience of illustration;
 FIG. 16 is a left side view of the cover (or cap) member with the holder body removed for convenience of illustration;
 FIG. 17 is a right side view of the cover (or cap) member with the holder body removed for convenience of illustration; and,
 FIG. 18 is a plan view of the cover (or cap) member with the holder body removed for convenience of illustration.

1 Claim, 5 Drawing Sheets

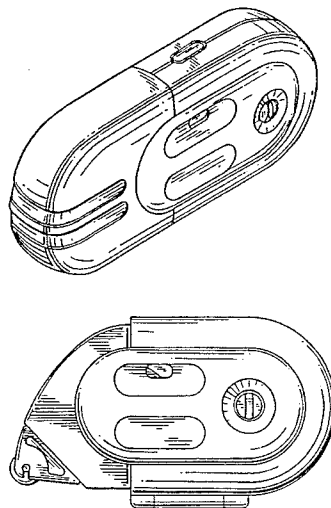

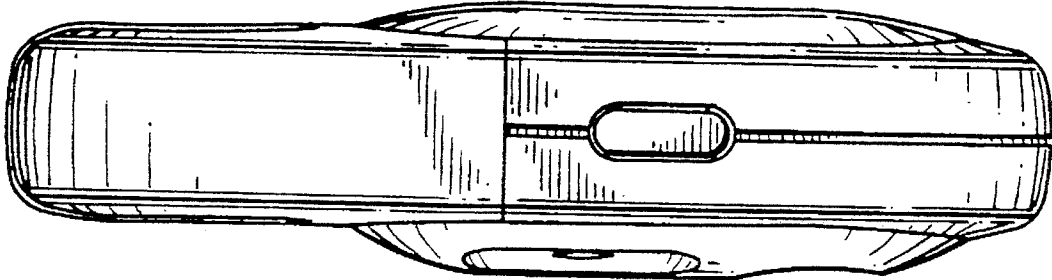

FIG. 1

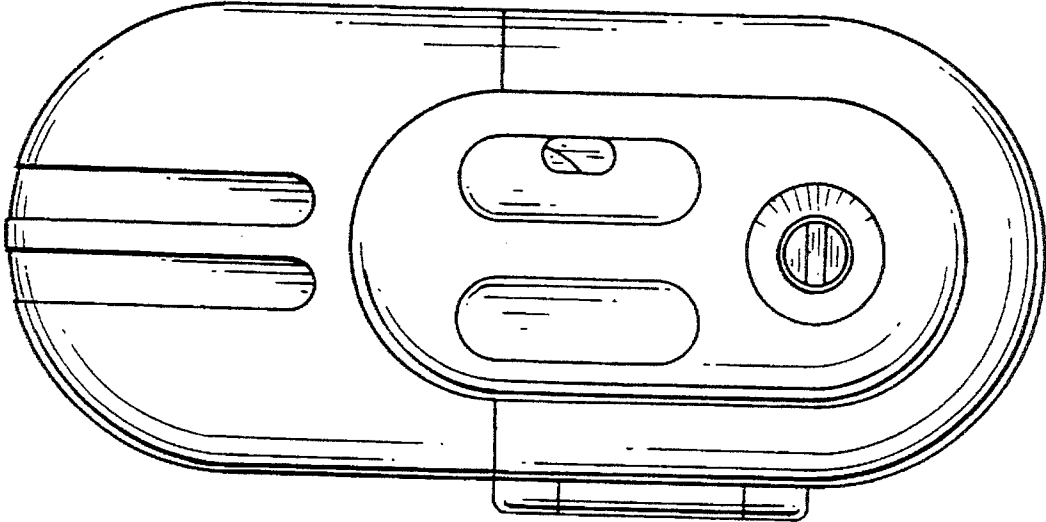

FIG. 2

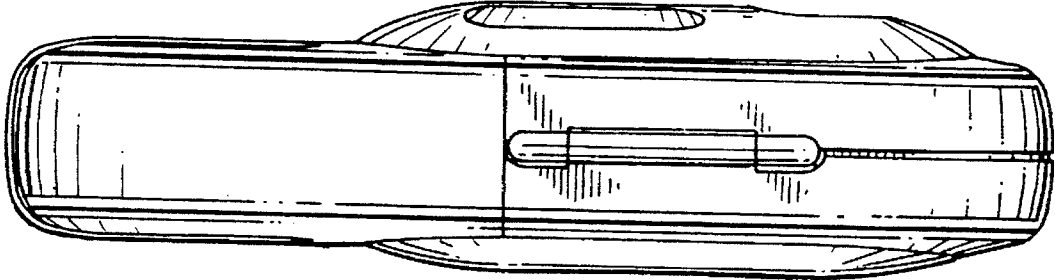

FIG. 3

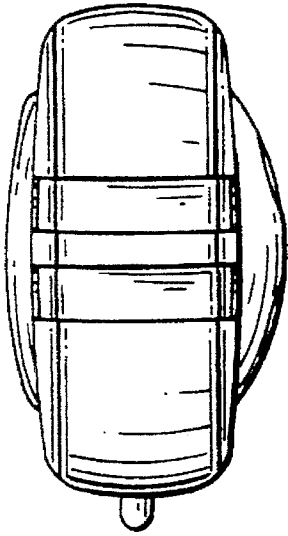

FIG. 4

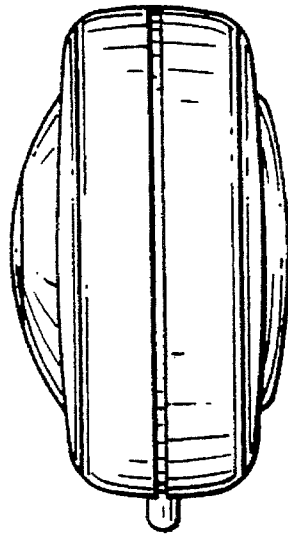

FIG. 5

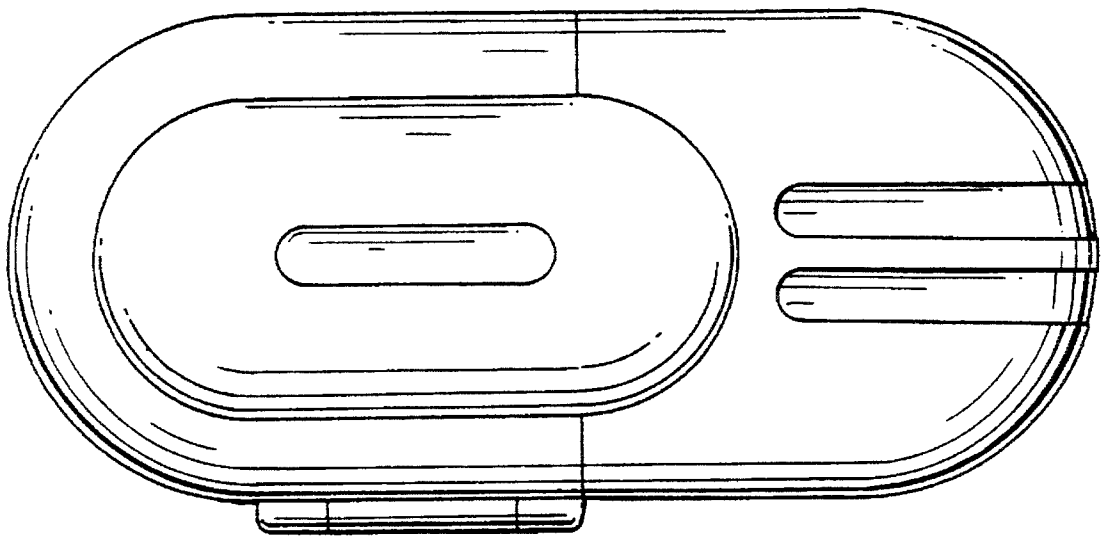

FIG. 6

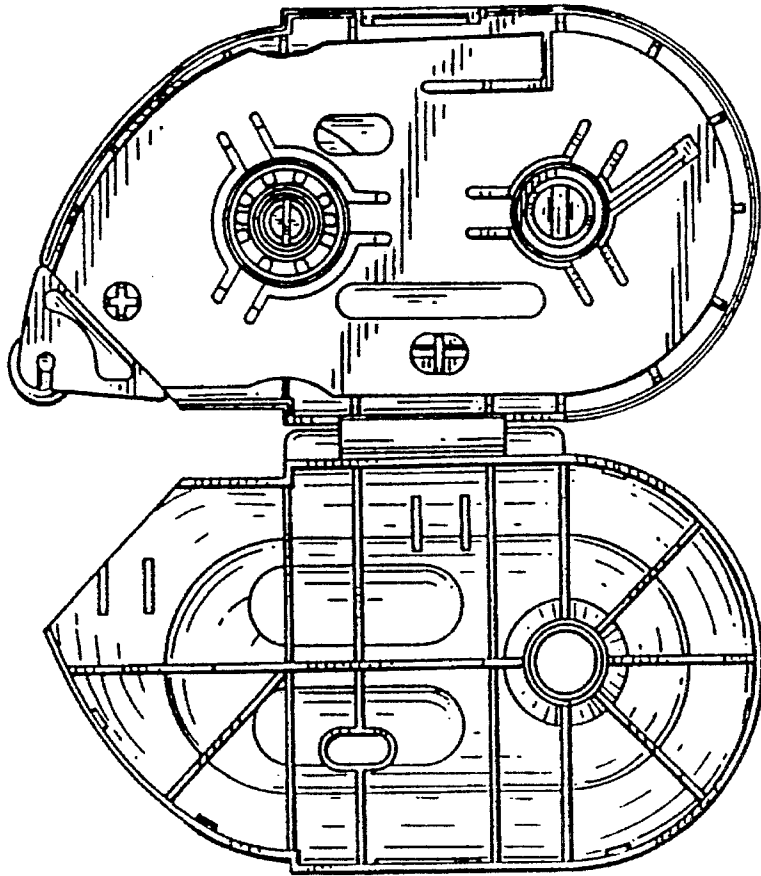

FIG. 7

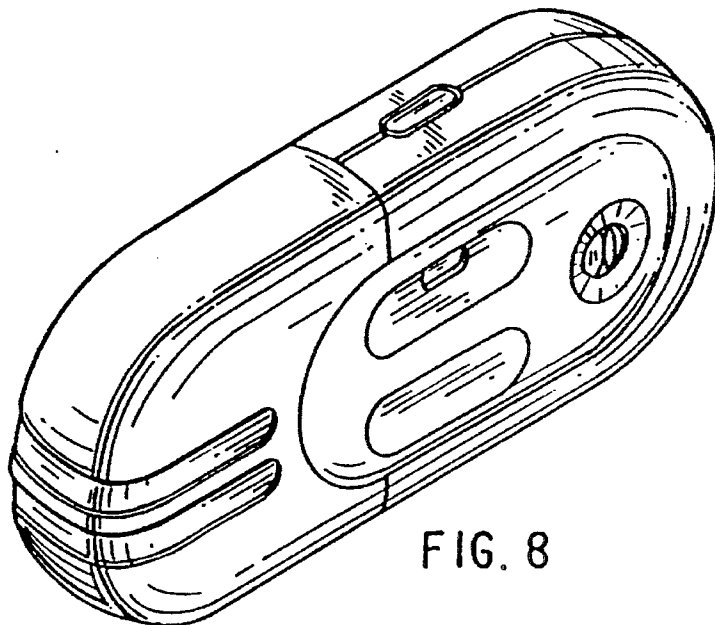

FIG. 8

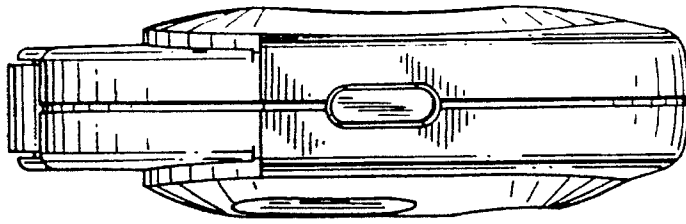

FIG. 9

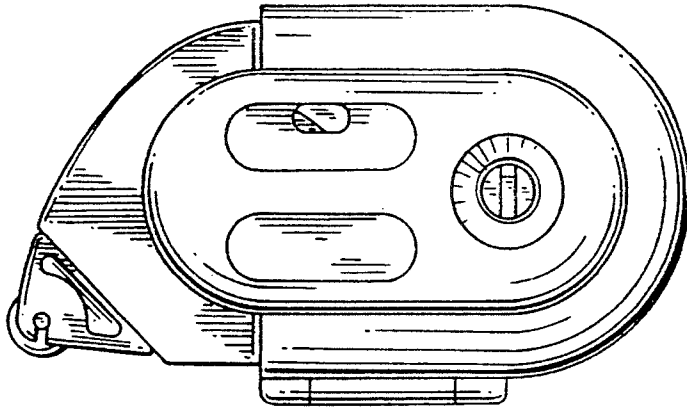

FIG. 10

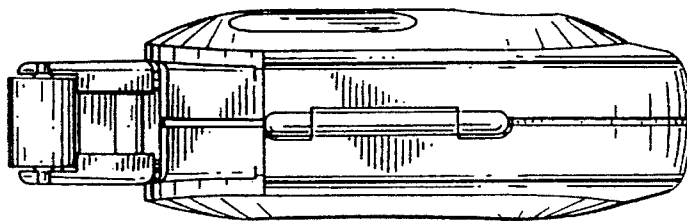

FIG. 11

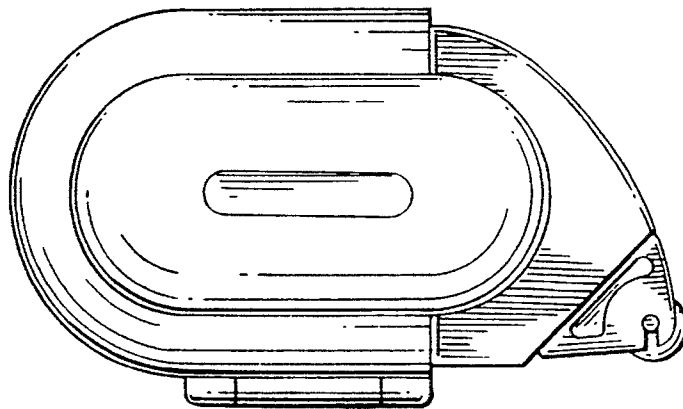

FIG. 12

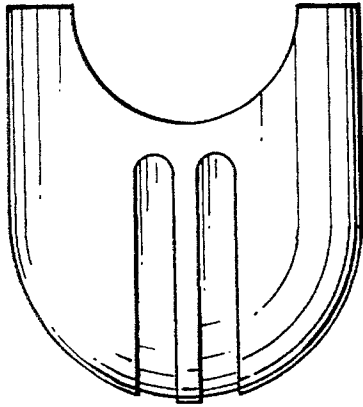

FIG. 15

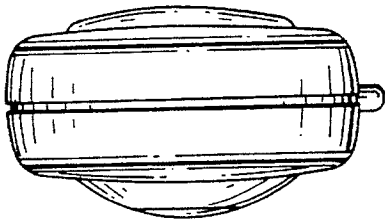

FIG. 14

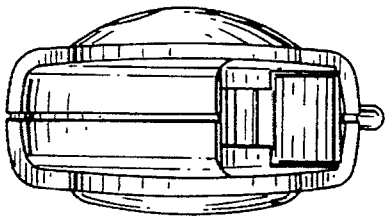

FIG. 13



FIG. 18

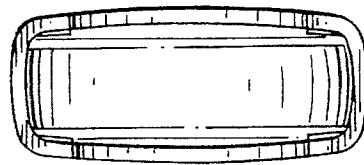

FIG. 17

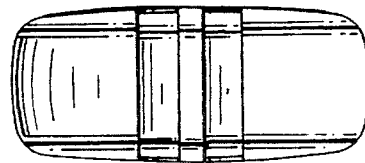

FIG. 16