



US0D1010809S

(12) **United States Design Patent**  
**Wang**

(10) **Patent No.:** **US D1,010,809 S**

(45) **Date of Patent:** **\*\* Jan. 9, 2024**

(54) **ORAL CLEANING TOOL**

(71) Applicant: **Zhiwei Wang**, Guangdong (CN)

(72) Inventor: **Zhiwei Wang**, Guangdong (CN)

(\*\*) Term: **15 Years**

(21) Appl. No.: **29/763,532**

(22) Filed: **Dec. 23, 2020**

(51) **LOC (14) Cl.** ..... **24-02**

(52) **U.S. Cl.**  
USPC ..... **D24/111**

(58) **Field of Classification Search**

USPC ..... D24/108, 111–115, 117, 121, 152, 156,  
D24/176; D4/101, 102, 110, 111, 138  
CPC ... A61C 17/0202; A61C 17/028; A61C 17/02;  
A61C 17/0211; A61C 17/36; A61C  
1/0015; A61C 17/16; A61C 17/34; A61C  
15/00; A61C 15/041; A61C 1/0061; A61C  
17/3481; A61C 15/046; A61C 15/04;  
A61C 17/0205; A61C 17/024

See application file for complete search history.

(56) **References Cited**

**U.S. PATENT DOCUMENTS**

D548,334 S \* 8/2007 Izumi ..... D24/111  
D694,398 S \* 11/2013 Taylor ..... D24/111  
D772,396 S \* 11/2016 Kim ..... D24/111  
D791,485 S \* 7/2017 McGarry ..... D4/138  
D804,016 S \* 11/2017 Ladwig ..... D24/111  
D806,228 S \* 12/2017 Yan ..... D24/176  
D815,274 S \* 4/2018 Ladwig ..... D24/111  
D819,196 S \* 5/2018 Kim ..... D24/111  
D881,383 S \* 4/2020 Chen ..... D24/111  
D888,935 S \* 6/2020 Fang ..... D24/111  
D907,195 S \* 1/2021 Li ..... D24/111  
D907,198 S \* 1/2021 Bessho ..... D24/111  
D913,486 S \* 3/2021 Bondurant ..... D24/111  
D914,198 S \* 3/2021 Li ..... D24/111  
D922,565 S \* 6/2021 Wang ..... D24/111  
D929,575 S \* 8/2021 Liu ..... D24/111

D939,690 S \* 12/2021 Honisch ..... D24/111  
D944,973 S \* 3/2022 Yu ..... D24/111  
D948,032 S \* 4/2022 Fang ..... D24/111  
D950,710 S \* 5/2022 Massie ..... D24/111  
2008/0008979 A1\* 1/2008 Thomas ..... A61C 17/028  
433/80  
2016/0151133 A1\* 6/2016 Luettgen ..... F04B 17/03  
433/80

(Continued)

**FOREIGN PATENT DOCUMENTS**

CN 306225986 \* 12/2020  
JP D1497334 \* 5/2014

**OTHER PUBLICATIONS**

Practical Test Panasonic Oral Irrigator EW1211A, Sep. 1, 2015,  
youtube.com [online], [site visited May 27, 2022], Available from  
Internet, URL: <https://www.youtube.com/watch?v=IPkWjDa4P2c>  
(Year: 2015).\*

(Continued)

*Primary Examiner* — Wendy L Arminio  
*Assistant Examiner* — Maheen Khurshid

(57) **CLAIM**

The ornamental design for an oral cleaning tool, as shown  
and described.

**DESCRIPTION**

FIG. 1 is a front elevational view of an oral cleaning tool  
showing my new design;  
FIG. 2 is a rear elevational view thereof;  
FIG. 3 is a left side view thereof;  
FIG. 4 is a right side view thereof;  
FIG. 5 is an enlarged top plan view thereof;  
FIG. 6 is an enlarged bottom plan view thereof;  
FIG. 7 is a perspective view thereof; and,  
FIG. 8 is another perspective view thereof.

**1 Claim, 8 Drawing Sheets**

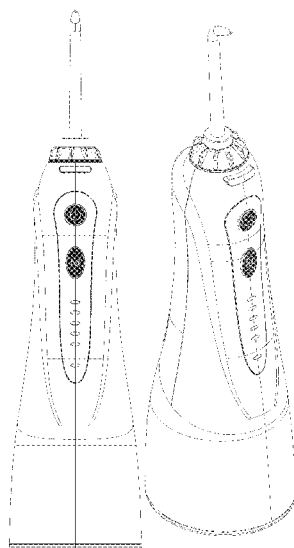

(56)

**References Cited**

U.S. PATENT DOCUMENTS

2019/0358006 A1\* 11/2019 Arias Haber ..... A61C 17/028  
2020/0268490 A1\* 8/2020 Bondurant ..... A61C 17/028  
2021/0030518 A1\* 2/2021 Zhou ..... A61C 17/028  
2021/0059801 A1\* 3/2021 Yu ..... A61C 17/0202

OTHER PUBLICATIONS

Panasonic Rechargeable Oral Irrigator EW1513W for Orthodontic Patients, Sep. 8, 2020, youtube.com [online], [site visited May 27, 2022], Available from Internet, URL: <<https://www.youtube.com/watch?v=sJPL5UVQpio>> (Year: 2020).\*

Waterpik Cordless Advanced Review, Jul. 1, 2021, youtube.com [online], [site visited May 27, 2022], Available from Internet, URL: <<https://www.youtube.com/watch?v=BryQWjmIJyU>> (Year: 2021).\*

Water Dental Flosser Cordless, Nov. 22, 2021, amazon.com [online], [site visited May 27, 2022], Available from Internet, URL: <[https://www.amazon.com/Water-Dental-Flosser-Cordless-Teeth/dp/B09MD4P75G/ref=psdc\\_13213826011\\_t1\\_B09VX51FGC](https://www.amazon.com/Water-Dental-Flosser-Cordless-Teeth/dp/B09MD4P75G/ref=psdc_13213826011_t1_B09VX51FGC)> (Year: 2021).\*

\* cited by examiner

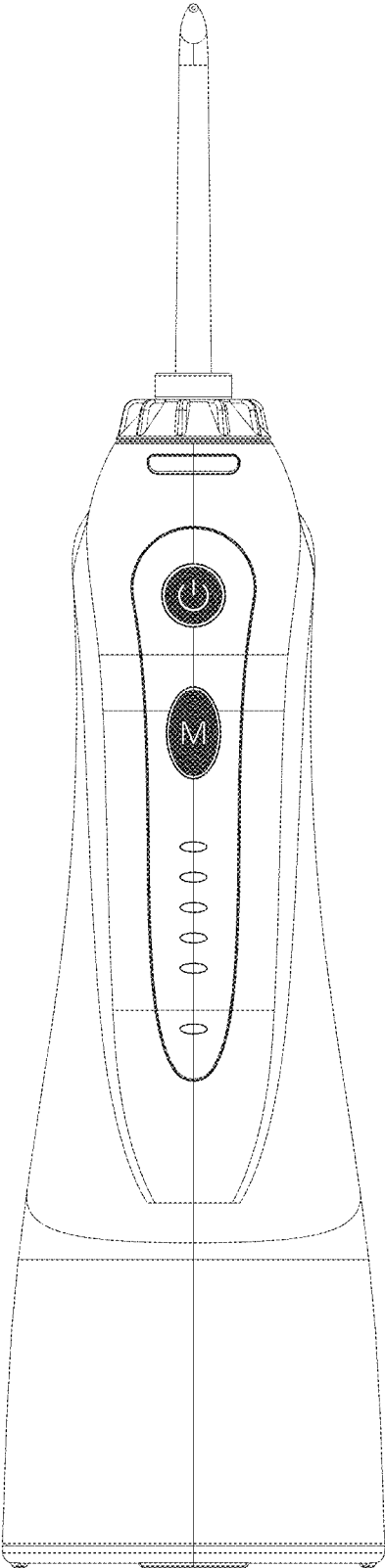

FIG.1

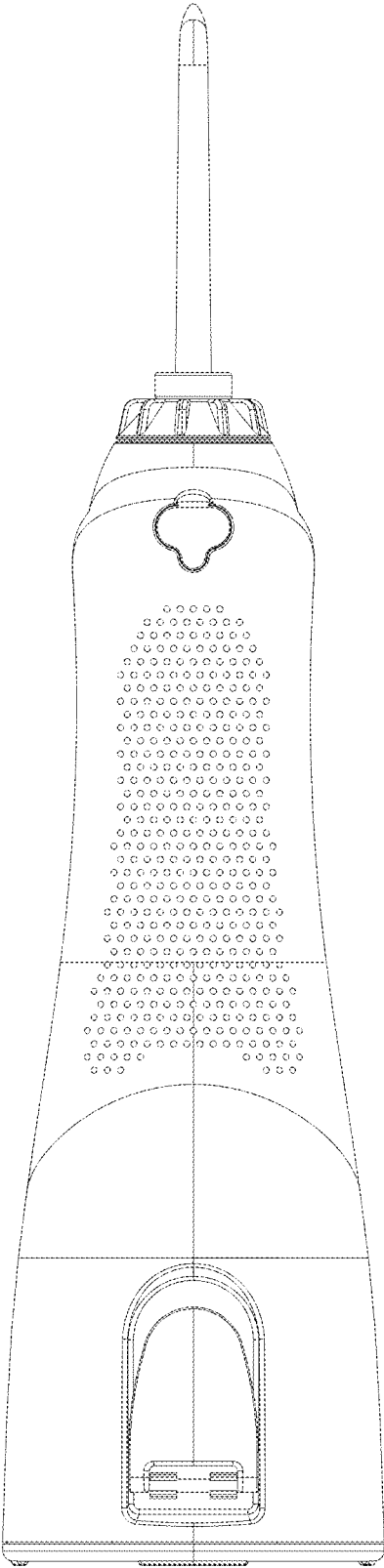

FIG. 2

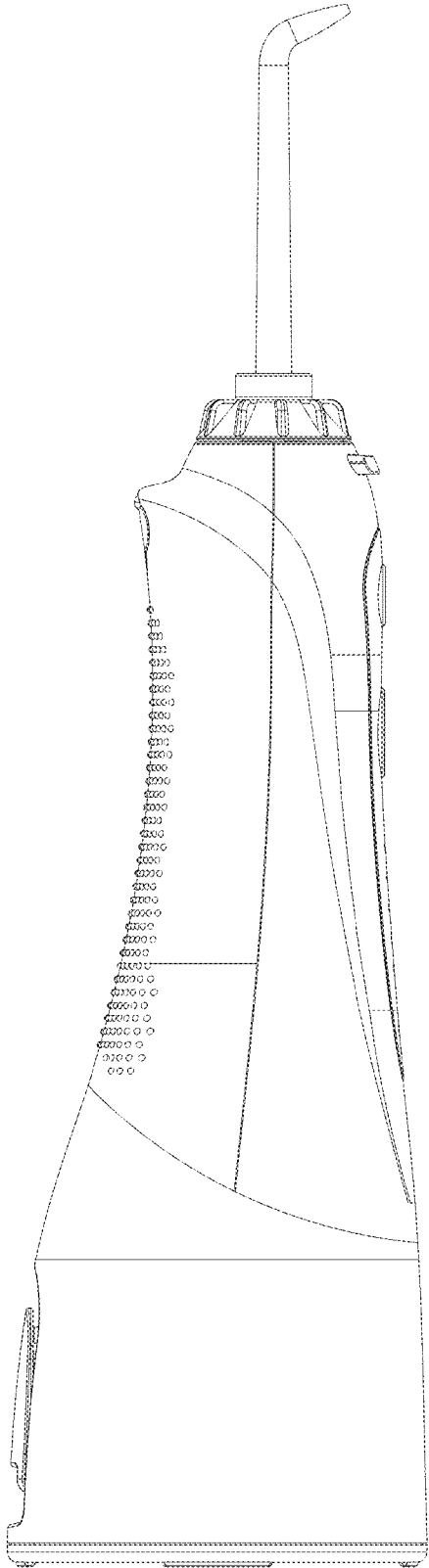

FIG.3

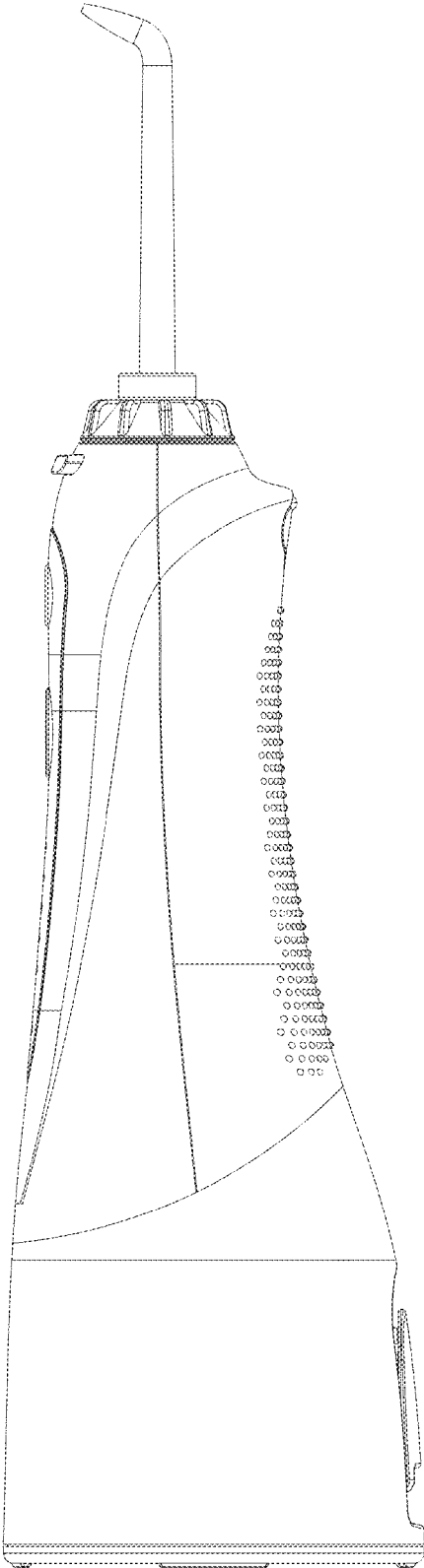

FIG. 4

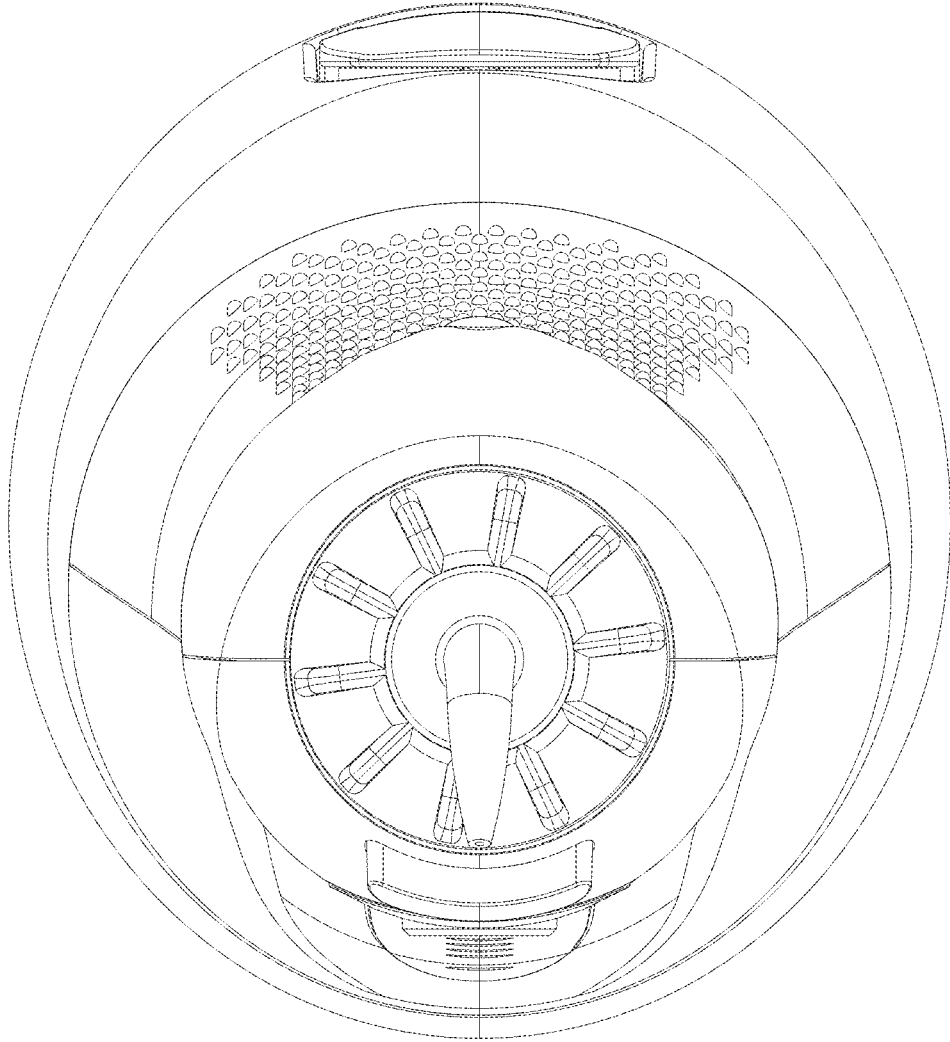

FIG. 5

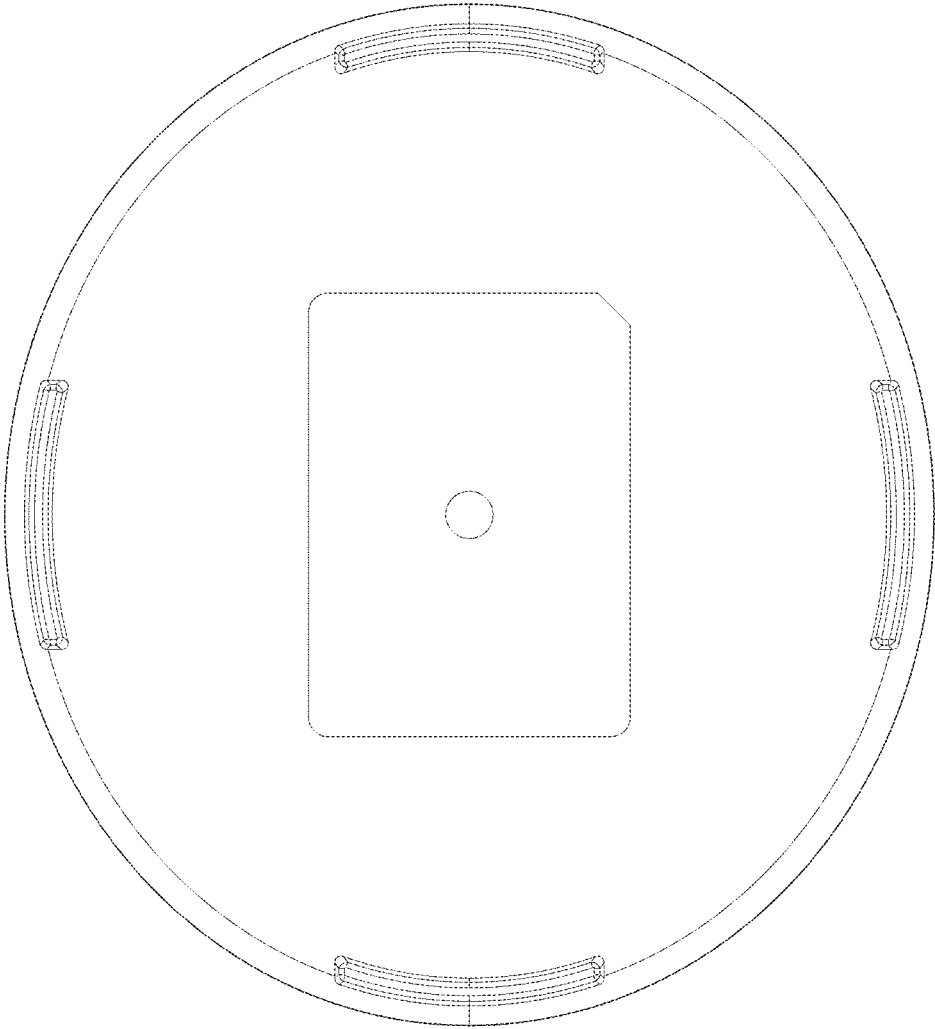

FIG. 6

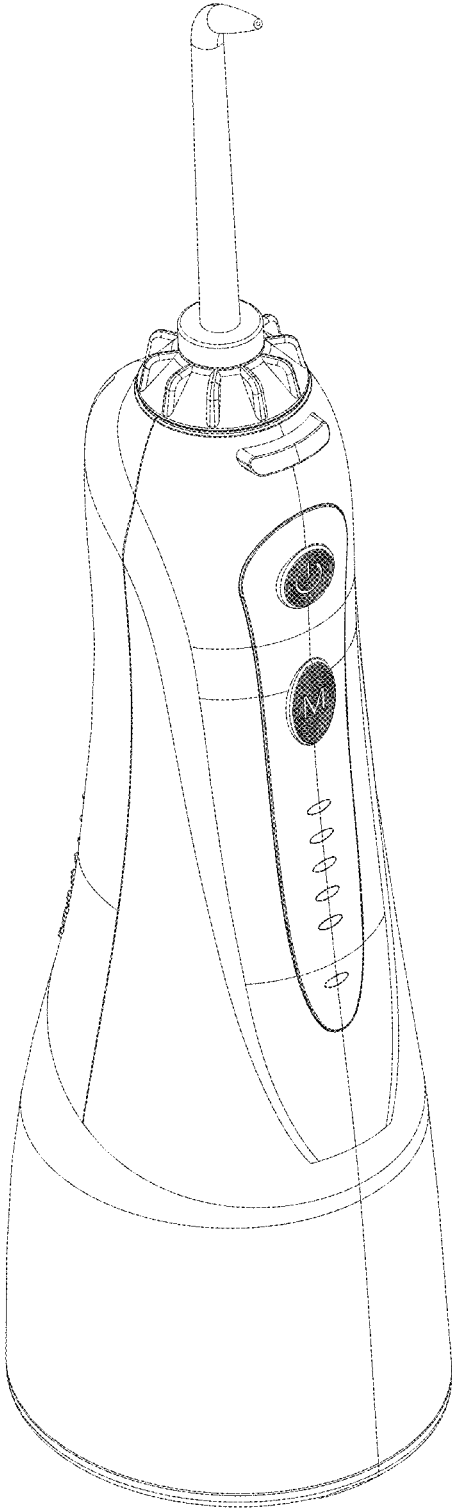

FIG. 7

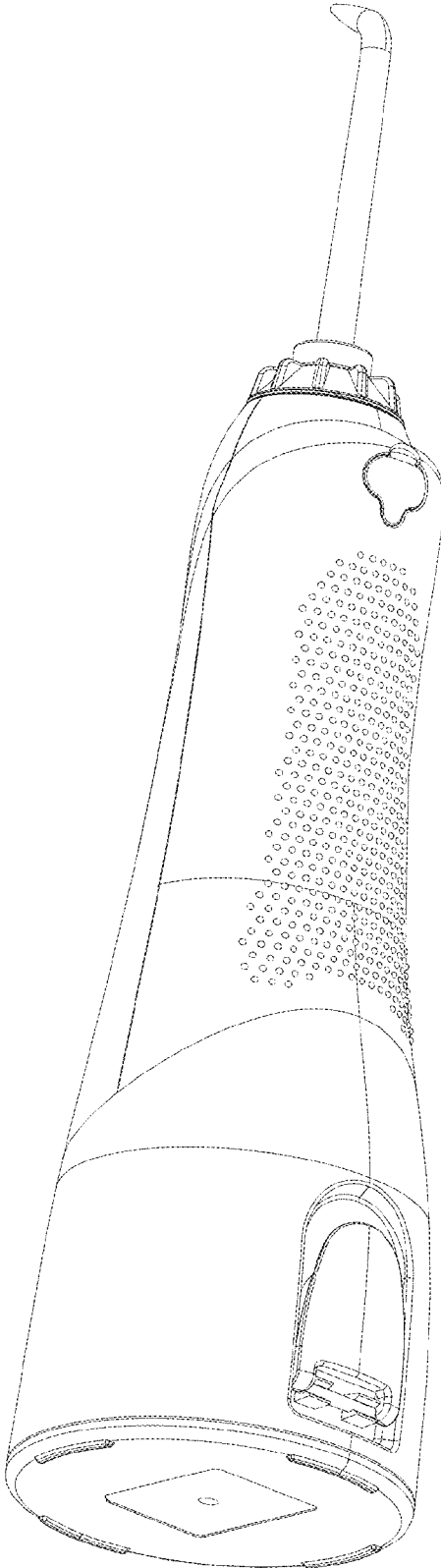

FIG.8