



US00D766729S

(12) **United States Design Patent** (10) **Patent No.:** **US D766,729 S**
Delgado Carmona (45) **Date of Patent:** **** Sep. 20, 2016**

(54) **BOTTLE WITH OWL SHAPE** D336,941 S * 6/1993 Leung D21/606
D603,465 S * 11/2009 Kelly D21/606
(71) Applicant: **Dart Industries Inc.**, Orlando, FL (US) D663,790 S * 7/2012 Williams D21/606
D699,946 S * 2/2014 Lee D3/271.1
(72) Inventor: **Sara L. Delgado Carmona**, Orlando, D713,260 S 9/2014 Delgado Carmona
FL (US) D713,261 S 9/2014 Delgado Carmona
D721,592 S * 1/2015 Peng D9/602

(73) Assignee: **Dart Industries Inc.**, Orlando, FL (US) * cited by examiner

(**) Term: **15 Years** *Primary Examiner* — Sandra Morris

(21) Appl. No.: **29/528,527** (74) *Attorney, Agent, or Firm* — Taylor J. Ross

(22) Filed: **May 29, 2015**

(51) **LOC (10) Cl.** **09-01**

(52) **U.S. Cl.**
USPC **D9/602**

(58) **Field of Classification Search**
USPC D9/600–603, 607–613; 206/457, 494,
206/459.5, 527, 540; 229/116.1; 446/77;
215/381–384, 400; D7/514–516, 539,
D7/544, 571, 579, 604, 613, 619.2,
D7/628–630, 391–392.1; D3/270–271.3;
D21/606
CPC B65D 67/00; B65D 81/36; B65D 81/60;
B65D 81/368; B65D 2203/00; B65D
2203/02; A63H 33/16
See application file for complete search history.

(56) **References Cited**

U.S. PATENT DOCUMENTS

D238,906 S * 2/1976 Cone D21/606
3,976,807 A * 8/1976 Sweeney B44F 9/00
206/457

(57) **CLAIM**

The ornamental design for a bottle with owl shape, as shown and described.

DESCRIPTION

FIG. 1 is a top, front and left side perspective view of a bottle with owl shape showing my new design;
FIG. 2 is a top plan view thereof;
FIG. 3 is a bottom plan view thereof. The broken lines in FIG. 3 are included for the purpose of illustrating a portion of the bottom that forms no part of the claimed design;
FIG. 4 is a front elevation view thereof;
FIG. 5 is a rear elevation view thereof;
FIG. 6 is a left side elevation view thereof; and,
FIG. 7 is a right side elevation view thereof.

1 Claim, 4 Drawing Sheets

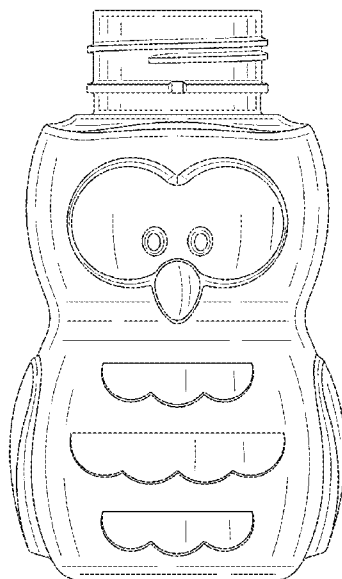

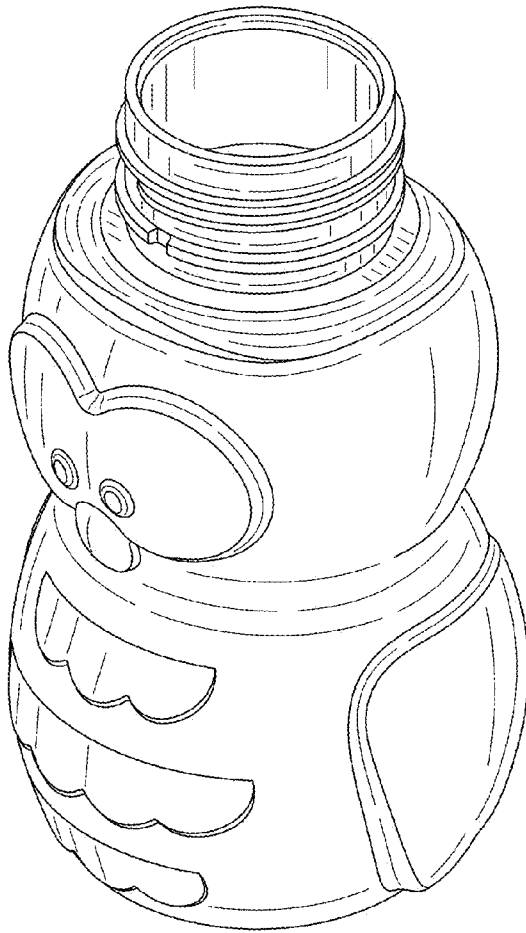

FIG. 1

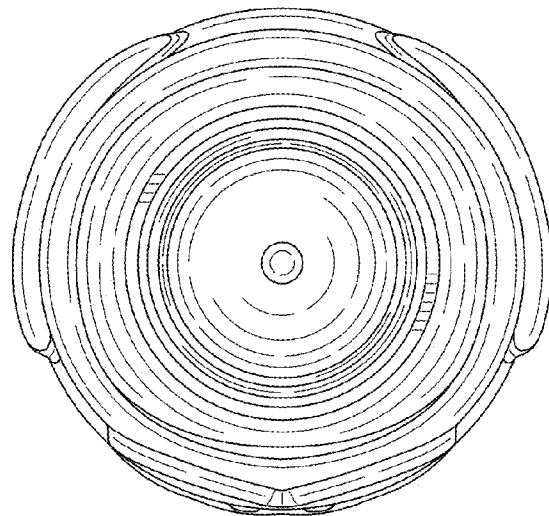

FIG. 2

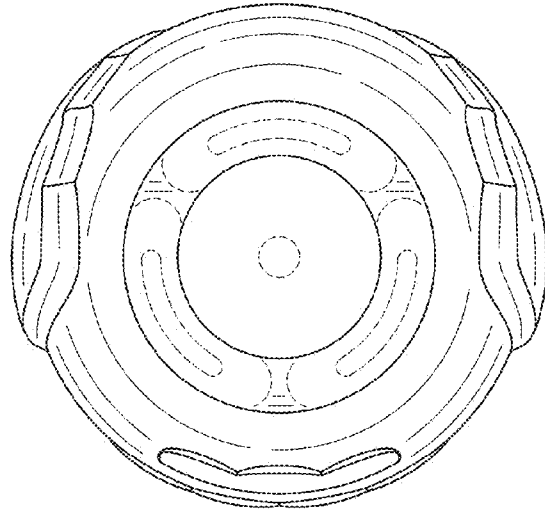

FIG. 3

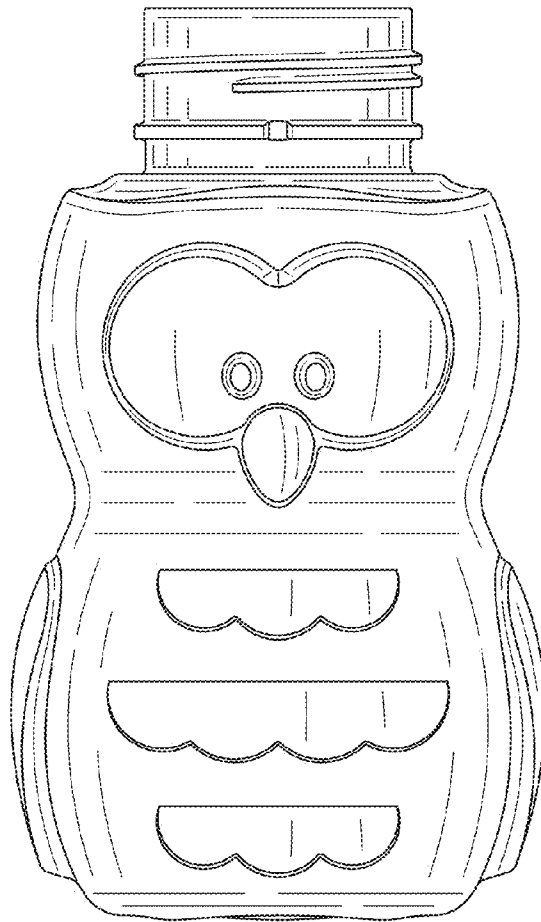

FIG. 4

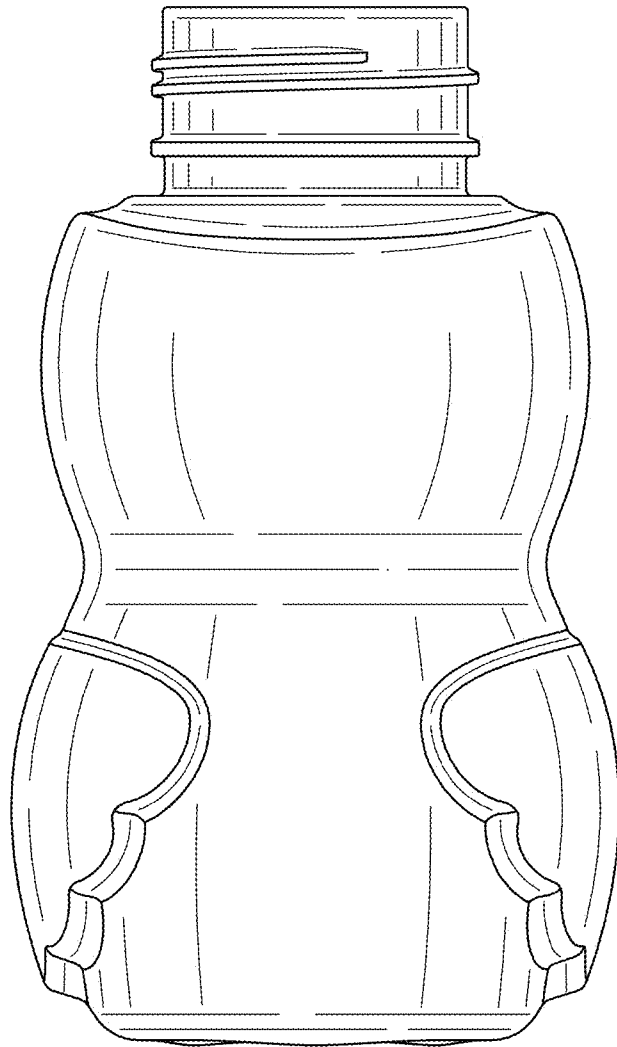

FIG. 5

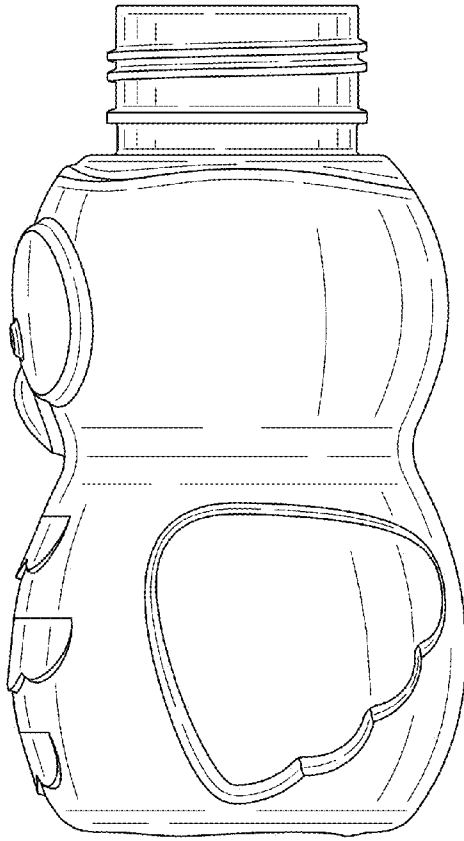

FIG. 6

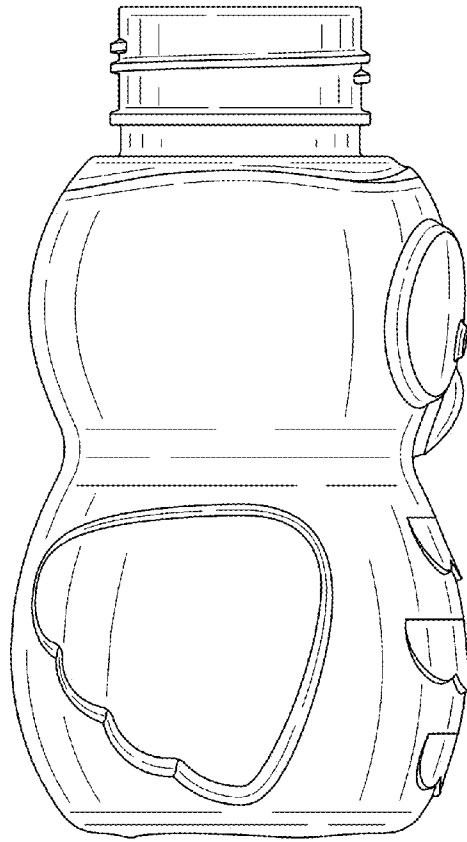

FIG. 7