



- (51) **International Patent Classification:**  
*H04B 7/26* (2006.01)    *H04J 11/00* (2006.01)
- (21) **International Application Number:**  
PCT/US2014/048106
- (22) **International Filing Date:**  
25 July 2014 (25.07.2014)
- (25) **Filing Language:** English
- (26) **Publication Language:** English
- (30) **Priority Data:**  
61/859,121    26 July 2013 (26.07.2013)    US  
14/318,445    27 June 2014 (27.06.2014)    US
- (71) **Applicant (for all designated States except US):** INTEL IP CORPORATION [US/US]; 2200 Mission College Boulevard, Santa Clara, California 95054 (US).
- (72) **Inventors; and**
- (71) **Applicants (for US only):** HAN, Seunghee [KR/US]; 10129 S. Blaney Ave #E, Cupertino, California 95014 (US). DAVYDOV, Alexei [RU/RU]; Lenin Ave 28/11-40, Nizhny Novgorod, 603132 (RU). HEO, Youn Hyong [KR/US]; 185 Estancia Drive, #236, San Jose, California 95134 (US). ZHU, Yuan [CN/CN]; Room 605, Building

16, Mo Li Yuan, Chao Yang District, Beijing 100012 (CN). FWU, Jong-Kae [US/US]; 1519 Dominion Ave, Sunnyvale, California 94087 (US).

- (74) **Agent:** KACVINSKY, John F.; Kacvinsky Daisak, PLLC, C/O CPA Global, P.O. Box 52050, Minneapolis, Minnesota 55402 (US).
- (81) **Designated States (unless otherwise indicated, for every kind of national protection available):** AE, AG, AL, AM, AO, AT, AU, AZ, BA, BB, BG, BH, BN, BR, BW, BY, BZ, CA, CH, CL, CN, CO, CR, CU, CZ, DE, DK, DM, DO, DZ, EC, EE, EG, ES, FI, GB, GD, GE, GH, GM, GT, HN, HR, HU, ID, IL, IN, IR, IS, JP, KE, KG, KN, KP, KR, KZ, LA, LC, LK, LR, LS, LT, LU, LY, MA, MD, ME, MG, MK, MN, MW, MX, MY, MZ, NA, NG, NI, NO, NZ, OM, PA, PE, PG, PH, PL, PT, QA, RO, RS, RU, RW, SA, SC, SD, SE, SG, SK, SL, SM, ST, SV, SY, TH, TJ, TM, TN, TR, TT, TZ, UA, UG, US, UZ, VC, VN, ZA, ZM, ZW.
- (84) **Designated States (unless otherwise indicated, for every kind of regional protection available):** ARIPO (BW, GH, GM, KE, LR, LS, MW, MZ, NA, RW, SD, SL, SZ, TZ, UG, ZM, ZW), Eurasian (AM, AZ, BY, KG, KZ, RU, TJ, TM), European (AL, AT, BE, BG, CH, CY, CZ, DE, DK, EE, ES, FI, FR, GB, GR, HR, HU, IE, IS, IT, LT, LU, LV,

[Continued on next page]

(54) **Title:** UPLINK COMMUNICATION TECHNIQUES FOR NON-IDEAL BACKHAUL SCENARIOS

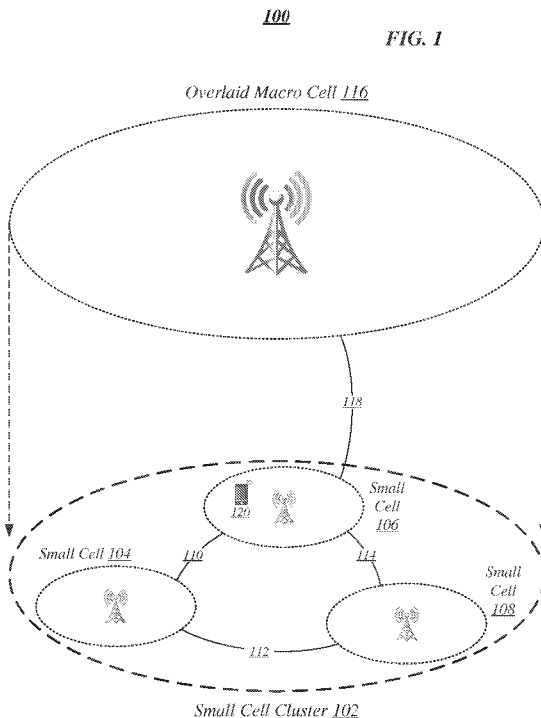

(57) **Abstract:** Uplink communication techniques for non-ideal backhaul scenarios are described. In one embodiment, for example, user equipment (UE) may comprise logic, at least a portion of which is in hardware, the logic to receive an uplink (UL) communication process configuration message identifying a configured UL communication process for the UE, the UL communication process configuration message comprising a cell identifier and one or more configuration information elements (IEs), each configuration IE comprising configuration information for UL communications on the part of the UE, the logic to send a UL message based on the configuration information comprised in at least one of the configuration IEs. Other embodiments are described and claimed.



**WO 2015/013563 A1** 

---

MC, MK, MT, NL, NO, PL, PT, RO, RS, SE, SI, SK, **Published:**  
SM, TR), OAPI (BF, BJ, CF, CG, CI, CM, GA, GN, GQ, — *with international search report (Art. 21(3))*  
GW, KM, ML, MR, NE, SN, TD, TG).

## UPLINK COMMUNICATION TECHNIQUES FOR NON-IDEAL BACKHAUL SCENARIOS

### RELATED CASE

5 This application claims priority to United States Provisional Patent Application Number 61/859,121, filed July 26, 2013, the entirety of which is hereby incorporated by reference.

### TECHNICAL FIELD

10 Embodiments herein generally relate to communications between devices in broadband wireless communications networks.

### BACKGROUND

In an evolved Universal Mobile Telecommunications System Terrestrial Radio Access Network (E-UTRAN), there may be regions in which the coverage areas of multiple evolved  
15 node Bs (eNBs) overlap. In one example, a small cell may overlap with another small cell and/or with an overlaid macrocell. In another example, in an edge region of one macrocell, coverage may be available not only from an eNB of that macrocell but also from an eNB of an adjacent macrocell. In some cases, it may be desirable that a user equipment (UE) residing in a region of overlapping coverage make use of the overlapping coverage to send uplink (UL) data  
20 to multiple eNBs at the same time. For example, it may be desirable that an eNB enter a dual-connectivity operation mode enabling concurrent UL transmission to both a small cell eNB and a second small cell eNB or an overlaid macrocell eNB. In another example, it may be desirable that an eNB utilize coordinated multipoint (CoMP) techniques to enable concurrent UL transmission to multiple eNBs and/or remote radio heads (RRHs).

25

### BRIEF DESCRIPTION OF THE DRAWINGS

**FIG. 1** illustrates an embodiment of a first operating environment.

**FIG. 2** illustrates an embodiment of a second operating environment.

**FIG. 3** illustrates an embodiment of a first apparatus and an embodiment of a first system.

30 **FIG. 4** illustrates an embodiment of a second apparatus and an embodiment of a second system.

**FIG. 5** illustrates an embodiment of a first logic flow.

**FIG. 6** illustrates an embodiment of a second logic flow.

**FIG. 7** illustrates an embodiment of a third logic flow.

**FIG. 8** illustrates an embodiment of a storage medium.

**FIG. 9** illustrates an embodiment a device.

**FIG. 10** illustrates an embodiment of a wireless network.

5

### **DETAILED DESCRIPTION**

Various embodiments are generally directed to uplink (UL) communication techniques for non-ideal backhaul scenarios. More particularly, various embodiments are directed to UL communication techniques to support dual-connectivity and/or UL-CoMP in non-ideal backhaul scenarios. In one embodiment, for example, user equipment (UE) may comprise logic, at least a portion of which is in hardware, the logic to receive an uplink (UL) communication process configuration message identifying a configured UL communication process for the UE, the UL communication process configuration message comprising a cell identifier and one or more configuration information elements (IEs), each configuration IE comprising configuration information for UL communications on the part of the UE, the logic to send a UL message based on the configuration information comprised in at least one of the configuration IEs. Other embodiments are described and claimed.

Various embodiments may comprise one or more elements. An element may comprise any structure arranged to perform certain operations. Each element may be implemented as hardware, software, or any combination thereof, as desired for a given set of design parameters or performance constraints. Although an embodiment may be described with a limited number of elements in a certain topology by way of example, the embodiment may include more or less elements in alternate topologies as desired for a given implementation. It is worthy to note that any reference to “one embodiment” or “an embodiment” means that a particular feature, structure, or characteristic described in connection with the embodiment is included in at least one embodiment. The appearances of the phrases “in one embodiment,” “in some embodiments,” and “in various embodiments” in various places in the specification are not necessarily all referring to the same embodiment.

The techniques disclosed herein may involve transmission of data over one or more wireless connections using one or more wireless mobile broadband technologies. For example, various embodiments may involve transmissions over one or more wireless connections according to one or more 3rd Generation Partnership Project (3GPP), 3GPP Long Term Evolution (LTE), and/or 3GPP LTE-Advanced (LTE-A) technologies and/or standards, including their revisions, progeny and variants. Various embodiments may additionally or alternatively involve transmissions according to one or more Global System for Mobile

Communications (GSM)/Enhanced Data Rates for GSM Evolution (EDGE), Universal Mobile Telecommunications System (UMTS)/High Speed Packet Access (HSPA), and/or GSM with General Packet Radio Service (GPRS) system (GSM/GPRS) technologies and/or standards, including their revisions, progeny and variants.

5           Examples of wireless mobile broadband technologies and/or standards may also include, without limitation, any of the Institute of Electrical and Electronics Engineers (IEEE) 802.16 wireless broadband standards such as IEEE 802.16m and/or 802.16p, International Mobile Telecommunications Advanced (IMT-ADV), Worldwide Interoperability for Microwave Access (WiMAX) and/or WiMAX II, Code Division Multiple Access (CDMA) 2000 (e.g., CDMA2000  
10 1xRTT, CDMA2000 EV-DO, CDMA EV-DV, and so forth), High Performance Radio Metropolitan Area Network (HIPERMAN), Wireless Broadband (WiBro), High Speed Downlink Packet Access (HSDPA), High Speed Orthogonal Frequency-Division Multiplexing (OFDM) Packet Access (HSOPA), High-Speed Uplink Packet Access (HSUPA) technologies and/or standards, including their revisions, progeny and variants.

15           Some embodiments may additionally or alternatively involve wireless communications according to other wireless communications technologies and/or standards. Examples of other wireless communications technologies and/or standards that may be used in various embodiments may include, without limitation, other IEEE wireless communication standards such as the IEEE 802.11, IEEE 802.11a, IEEE 802.11b, IEEE 802.11g, IEEE 802.11n, IEEE  
20 802.11u, IEEE 802.11ac, IEEE 802.11ad, IEEE 802.11af, and/or IEEE 802.11ah standards, High-Efficiency Wi-Fi standards developed by the IEEE 802.11 High Efficiency WLAN (HEW) Study Group, Wi-Fi Alliance (WFA) wireless communication standards such as Wi-Fi, Wi-Fi Direct, Wi-Fi Direct Services, Wireless Gigabit (WiGig), WiGig Display Extension (WDE), WiGig Bus Extension (WBE), WiGig Serial Extension (WSE) standards and/or standards  
25 developed by the WFA Neighbor Awareness Networking (NAN) Task Group, machine-type communications (MTC) standards such as those embodied in 3GPP Technical Report (TR) 23.887, 3GPP Technical Specification (TS) 22.368, and/or 3GPP TS 23.682, and/or near-field communication (NFC) standards such as standards developed by the NFC Forum, including any revisions, progeny, and/or variants of any of the above. The embodiments are not limited to  
30 these examples.

In addition to transmission over one or more wireless connections, the techniques disclosed herein may involve transmission of content over one or more wired connections through one or more wired communications media. Examples of wired communications media may include a wire, cable, metal leads, printed circuit board (PCB), backplane, switch fabric, semiconductor

material, twisted-pair wire, co-axial cable, fiber optics, and so forth. The embodiments are not limited in this context.

**FIG. 1** illustrates an operating environment 100 such as may comprise an example of an operating environment in which UL communication techniques for non-ideal backhaul scenarios may be implemented in some embodiments. More particularly, operating environment 100 may be representative of various embodiments in which a UE concurrently receives/transmits from/to multiple eNBs in conjunction with operating in a dual-connectivity mode. As shown in FIG. 1, in operating environment 100, a small cell cluster 102 comprises small cells 104, 106, and 108. Small cell 104 communicates with small cell 106 via a backhaul 110 and communicates with small cell 108 via a backhaul 112, while small cell 106 communicates with small cell 108 via a backhaul 114. In some embodiments, some or all of backhauls 110, 112, and 114 may comprise non-ideal backhauls. For example, in various embodiments, some or all of backhauls 110, 112, and 114 may comprise backhauls that are categorized as non-ideal according to Table 6.1-1 in 3GPP TR 36.932. In some embodiments, an overlaid macrocell 116 may be overlaid upon all or part of small cell cluster 102. In various such embodiments, the overlaid macrocell 116 may communicate with small cell cluster 102 via a backhaul 118. In some embodiments, the backhaul 118 may comprise a non-ideal backhaul.

In the example of FIG. 1, a UE 120 is located in small cell 106. In various embodiments, the UE 120 may operate in a dual-connectivity mode, according to which it consumes resource radio resources of multiple eNBs that are interconnected by a non-ideal backhaul. For example, in some embodiments, the UE 120 may utilize a UL channel of small cell 106 and also utilize a UL channel of overlaid macrocell 116, and the backhaul 118 that connects the two may comprise a non-ideal backhaul. In another example, in various embodiments, the UE 120 may utilize a UL channel of small cell 106 and also utilize a UL channel of small cell 104, and the backhaul 110 that connects small cell 104 and small cell 106 may comprise a non-ideal backhaul. The embodiments are not limited to these examples.

**FIG. 2** illustrates an operating environment 200 such as may comprise another example of an operating environment in which UL communication techniques for non-ideal backhaul scenarios may be implemented in some embodiments. More particularly, operating environment 200 may be representative of various embodiments in which a UE concurrently receives/transmits from/to multiple eNBs in conjunction with operating in a DL/UL-CoMP mode with non-ideal backhaul. As shown in FIG. 2, in operating environment 200, cells 202, 204, and 206 are served by respective eNBs 208, 210, and 212. eNBs 208 and 210 are connected by a backhaul 214, which may comprise a non-ideal backhaul. A UE 220 is located in a cell edge

region of cell 204 that is close to cell 202. In some embodiments, its proximity to cell 202 may enable the UE 220 to implement UL-CoMP to make use of UL channel resources of cell 202 while concurrently using UL channel resources of cell 204. It is worthy of note that the embodiments are not limited to the example of FIG. 2. For example, in various embodiments, 5 UL-CoMP may be implemented in conjunction with one or more of the example scenarios described in clause 5.1.2 of 3GPP TR 36.819. The embodiments are not limited in this context.

**FIG. 3** illustrates a block diagram of an apparatus 300. Apparatus 300 may be representative of a UE that may implement UL communication techniques for non-ideal backhaul scenarios in some embodiments. For example, apparatus 300 may be representative of 10 UE 120 of FIG. 1 and/or UE 220 of FIG. 2. In various embodiments, apparatus 300 may be representative of a UE operating in a dual-connectivity mode, according to which it consumes radio resources provided by a master eNB (MeNB) and at least one secondary eNB (SeNB) connected with a non-ideal backhaul. In the following discussion, such embodiments shall be referred to as “dual-connectivity embodiments.” In some embodiments, apparatus 300 may be 15 representative of a UE operating in a UL-CoMP mode according to which it communicates with multiple eNBs and/or RRHs connected with a non-ideal backhaul. In the following discussion, such embodiments shall be referred to as “UL-CoMP embodiments.” As shown in FIG. 3, apparatus 300 comprises multiple elements including a processor circuit 302, a memory unit 304, and a communications component 306. The embodiments, however, are not limited to the type, 20 number, or arrangement of elements shown in this figure.

In various embodiments, apparatus 300 may comprise processor circuit 302. Processor circuit 302 may be implemented using any processor or logic device, such as a complex instruction set computer (CISC) microprocessor, a reduced instruction set computing (RISC) microprocessor, a very long instruction word (VLIW) microprocessor, an x86 instruction set 25 compatible processor, a processor implementing a combination of instruction sets, a multi-core processor such as a dual-core processor or dual-core mobile processor, or any other microprocessor or central processing unit (CPU). Processor circuit 302 may also be implemented as a dedicated processor, such as a controller, a microcontroller, an embedded processor, a chip multiprocessor (CMP), a co-processor, a digital signal processor (DSP), a 30 network processor, a media processor, an input/output (I/O) processor, a media access control (MAC) processor, a radio baseband processor, an application specific integrated circuit (ASIC), a field programmable gate array (FPGA), a programmable logic device (PLD), and so forth. In one embodiment, for example, processor circuit 302 may be implemented as a general purpose

processor, such as a processor made by Intel® Corporation, Santa Clara, Calif. The embodiments are not limited in this context.

In some embodiments, apparatus 300 may comprise or be arranged to communicatively couple with a memory unit 304. Memory unit 304 may be implemented using any machine-  
5 readable or computer-readable media capable of storing data, including both volatile and non-volatile memory. For example, memory unit 304 may include read-only memory (ROM), random-access memory (RAM), dynamic RAM (DRAM), Double-Data-Rate DRAM (DDRAM), synchronous DRAM (SDRAM), static RAM (SRAM), programmable ROM (PROM), erasable programmable ROM (EPROM), electrically erasable programmable ROM (EEPROM), flash memory, polymer memory such as ferroelectric polymer memory, ovonic  
10 memory, phase change or ferroelectric memory, silicon-oxide-nitride-oxide-silicon (SONOS) memory, magnetic or optical cards, or any other type of media suitable for storing information. It is worthy of note that some portion or all of memory unit 304 may be included on the same integrated circuit as processor circuit 302, or alternatively some portion or all of memory unit  
15 304 may be disposed on an integrated circuit or other medium, for example a hard disk drive, that is external to the integrated circuit of processor circuit 302. Although memory unit 304 is comprised within apparatus 300 in FIG. 3, memory unit 304 may be external to apparatus 300 in various embodiments. The embodiments are not limited in this context.

In some embodiments, apparatus 300 may comprise a communications component 306.  
20 Communications component 306 may comprise logic, circuitry, and/or instructions operative to send messages to one or more remote devices and/or to receive messages from one or more remote devices. In various embodiments, communications component 306 may be operative to send and/or receive messages over one or more wired connections, one or more wireless connections, or a combination of both. In some embodiments, communications component 306  
25 may additionally comprise logic, circuitry, and/or instructions operative to perform various operations in support of such communications. Examples of such operations may include selection of transmission and/or reception parameters and/or timing, packet and/or protocol data unit (PDU) construction and/or deconstruction, encoding and/or decoding, error detection, and/or error correction. The embodiments are not limited to these examples.

FIG. 3 also illustrates a block diagram of a system 340. System 340 may comprise any of  
30 the aforementioned elements of apparatus 300. System 340 may further comprise a radio frequency (RF) transceiver 342. RF transceiver 342 may comprise one or more radios capable of transmitting and receiving signals using various suitable wireless communications techniques. Such techniques may involve communications across one or more wireless networks.

Exemplary wireless networks include (but are not limited to) cellular radio access networks, wireless local area networks (WLANs), wireless personal area networks (WPANs), wireless metropolitan area network (WMANs), and satellite networks. In communicating across such networks, RF transceiver 342 may operate in accordance with one or more applicable standards  
5 in any version. The embodiments are not limited in this context.

In various embodiments, system 340 may comprise one or more RF antennas 344. Examples of any particular RF antenna 344 may include, without limitation, an internal antenna, an omni-directional antenna, a monopole antenna, a dipole antenna, an end-fed antenna, a circularly polarized antenna, a micro-strip antenna, a diversity antenna, a dual antenna, a tri-band  
10 antenna, a quad-band antenna, and so forth. In some embodiments, RF transceiver 342 may be operative to send and/or receive messages and/or data using one or more RF antennas 344. The embodiments are not limited in this context.

In various embodiments, system 340 may comprise a display 346. Display 346 may comprise any display device capable of displaying information received from processor circuit  
15 302. Examples for display 346 may include a television, a monitor, a projector, and a computer screen. In one embodiment, for example, display 346 may be implemented by a liquid crystal display (LCD), light emitting diode (LED) or other type of suitable visual interface. Display 346 may comprise, for example, a touch-sensitive display screen (“touchscreen”). In some implementations, display 346 may comprise one or more thin-film transistors (TFT) LCD  
20 including embedded transistors. The embodiments, however, are not limited to these examples.

In various embodiments, during general operation of apparatus 300 and/or system 340, communications component 306 may be operative to receive a UL communication process configuration message 308 from an eNB 350. In some embodiments, the UL communication process configuration message 308 may comprise a UL communication process information  
25 element (IE). In various embodiments, communications component 306 may be operative to receive the UL communication process configuration message 308 from the eNB 350 over a downlink control channel, such as a physical downlink control channel (PDCCH) of an E-UTRAN. In some other embodiments, communications component 306 may be operative to receive the UL communication process configuration message 308 from the eNB 350 over a  
30 different type of channel. In various dual-connectivity embodiments, the eNB 350 may comprise an MeNB for apparatus 300 and/or system 340. In some other dual-connectivity embodiments, the eNB 350 may comprise an SeNB for apparatus 300 and/or system 340. In various embodiments, rather than being received directly from eNB 350, UL communication process configuration message 308 may be received indirectly, via one or more intermediate nodes. For

example, in some embodiments, communications component 306 may be operative to receive UL communication process configuration message 308 from eNB 350 indirectly, via an intermediate RRH. The embodiments are not limited to this example.

In various embodiments, UL communication process configuration message 308 may describe a UL communication process that has been configured for apparatus 300 and/or system 340. In some such embodiments, UL communication process configuration message 308 may describe a UL communication process that has been configured for apparatus 300 and/or system 340 by eNB 350 and/or one or more other eNBs. In various dual-connectivity embodiments, UL communication process configuration message 308 may describe a UL communication process that has been configured for apparatus 300 and/or system 340 by an MeNB for apparatus 300 and/or system 340 and/or by an SeNB for apparatus 300 and/or system 340. In some UL-CoMP embodiments, UL communication process configuration message 308 may describe a UL communications process that has been configured for apparatus 300 and/or system 340 by a macrocell eNB for apparatus 300 and/or system 340. In various embodiments, UL communication process configuration message 308 may comprise a UL process identifier (ID) 310. In some embodiments, UL process ID 310 may comprise a name, number, or other value that uniquely identifies the configured UL communication process to which UL communication process configuration message 308 corresponds. The embodiments are not limited in this context.

In various embodiments, UL communication process configuration message 308 may comprise a cell identifier 312. In some embodiments, cell identifier 312 may identify a cell or cell sector with which the UL communication process described by UL communication process configuration message 308 is associated. Examples of cell identifier 312 may include, without limitation, a cell index, a physical cell identifier, and a global cell identifier. In various dual-connectivity embodiments, cell identifier 312 may identify a macrocell or a small cell. In some UE-CoMP embodiments, cell identifier 312 may identify a macrocell or a cell sector. In various embodiments, by virtue of identifying a particular cell or cell sector, cell identifier 312 may also identify an eNB or RRH that provides coverage to that cell or cell sector. For example, in some dual-connectivity embodiments, cell identifier 312 may identify an SeNB or an MeNB. In various UL-CoMP embodiments, cell identifier 312 may identify a macrocell eNB or an RRH. In some embodiments, the inclusion of cell identifier 312 in UL communication process configuration message 308 may enable apparatus 300 and/or system 340 to identify an eNB or RRH to which UL communication process configuration message 308 and to determine a

pathloss associated with UL communications with that eNB or RRH. The embodiments are not limited in this context.

In various embodiments, the UL communication process described by UL communication process configuration message 308 may define parameters according to which apparatus 300 and/or system 340 is to perform various types of UL communications. In some embodiments, the defined parameters may apply to UL communications within a cell or cell sector specified by cell identifier 312 and/or may apply to UL communications with an eNB or RRH specified by cell identifier 312. In various embodiments, some or all of the defined parameters may apply to UL communications over one or more particular wireless channels. In some embodiments, for example, some or all the defined parameters may apply to UL communications on the part of apparatus 300 and/or system 340 over one or more of a physical uplink control channel (PUCCH), a physical uplink shared channel (PUSCH), and a random access channel (RACH). In various embodiments, some or all of the defined parameters may apply to particular types of signals. In some embodiments, for example, the defined parameters may include one or more parameters that apply to the transmission of sounding reference signals on the part of apparatus 300 and/or system 340. The embodiments are not limited to these examples.

In various embodiments, UL communication process configuration message 308 may comprise one or more configuration parameters 314. In some embodiments, some or all of configuration parameters 314 may correspond to particular respective UL channels or signals, and may comprise configuration information applicable to communications by apparatus 300 and/or system 340 via those respective UL channels or signals. In various embodiments, one or more configuration parameters 314 may not correspond to particular UL channels or signals, but rather may correspond to particular UL transmission parameters. For example, in some embodiments, a given configuration parameter 314 may comprise configuration information that is applicable to UL power control operations on the part of apparatus 300 and/or system 340. It is worthy of note that in various embodiments, one or more configuration parameters 314 may comprise configuration information that may be applied to open-loop power control operations, closed-loop power control operations, or both. In some embodiments, one or more configuration parameters 314 may comprise UE-specific parameters that are specific to apparatus 300 and/or system 340. In various embodiments, one or more configuration parameters 314 may additionally or alternatively comprise cell-specific parameters that are specific to UL communications within a cell or cell sector specified by cell identifier 312. The embodiments are not limited in this context.

In some embodiments, apparatus 300 and/or system 340 may be provided with a UL channel/signal group communication process configuration message 308 that comprises a set of configuration parameters 314, each corresponding to a respective one of a set of UL channels and/or signals. For example, in various embodiments, apparatus 300 and/or system 340 may be provided with a UL channel/signal group communication process configuration message 308 that comprises a configuration parameter 314 for a PUCCH, a configuration parameter 314 for a PUSCH, and a configuration parameter 314 for an RACH. Presented in Abstract Syntax Notation One (ASN.1) format below is an information element (IE) such as may comprise an example of a format for a UL channel/signal group communication process configuration message 308 in some embodiments:

```

-- ASN1START

UL-Process-r12 ::=          SEQUENCE {
15   ul-ProcessId-r12          UL-ProcessId-r12,
   soundingRS-UL-Config      SoundingRS-UL-Config
   pucch-Config              PUCCH-Config
   rach-Config              RACH-Config
   pusch-Config              PUSCH-Config
20   uplinkPowerControlDedicated UplinkPowerControl
   cell-index-Config         CELL-index-Config
   ...
}

25 -- ASN1STOP

-- ASN1START

30 ul-processId-r12 ::=      INTEGER (1...maxUL-Proc-r12)

-- ASN1STOP

```

where maxUL-Proc-r12 represents a maximum number of UL communication processes that may be configured. It is worthy of note that the suffix “r12” is featured in the above example to indicate that the depicted IE may be associated with 3GPP Release 12 in various embodiments. However, the embodiments are not limited to this example.

5 In some embodiments, apparatus 300 and/or system 340 may be provided with a set of individual UL channel/signal communication process configuration messages 308, each comprising a single configuration parameter 314 corresponding to a respective one of a set of UL channels and/or signals. For example, in various embodiments, apparatus 300 and/or system 340 may be provided with a first UL communication process configuration message 308 that  
 10 comprises a configuration parameter 314 for a PUCCH, a second UL communication process configuration message 308 that comprises a configuration parameter 314 for a PUSCH, and a third UL communication process configuration message 308 that comprises a configuration parameter 314 for an RACH. Presented in ASN.1 format below is are a set of IEs such as may be representative of the formats of a set of individual UL channel/signal communication process  
 15 configuration messages 308 in some embodiments:

-- ASN1START

20 UL-Process-soundingRS-Config-r12 ::= SEQUENCE {  
     ul-ProcessId-r12                  UL-ProcessId-r12,  
     soundingRS-UL-Config              SoundingRS-UL-Config  
     ...  
 }

25 UL-Process-PUCCH-Config-r12 ::= SEQUENCE {  
     ul-ProcessId-r12                  UL-ProcessId-r12,  
     pucch-Config                      PUCCH-Config  
     ...  
 }

30 UL-Process-RACH-Config-r12 ::= SEQUENCE {  
     ul-ProcessId-r12                  UL-ProcessId-r12,  
     rach-Config                       RACH-Config  
     ...

```

    }

    UL-Process-PUSCH-Config-r12 ::=                SEQUENCE {
        ul-ProcessId-r12                UL-ProcessId-r12,
5      pusched-Config                    PUSCH-Config
        ...
    }

-- ASN1STOP
10

-- ASN1START

ul-processId-r12 ::=                INTEGER (1...maxUL-Proc-r12)
15

-- ASN1STOP

```

where maxUL-Proc-r12 represents a maximum number of UL communication processes that may be configured. It is worthy of note that the suffix “r12” is featured in the above example to indicate that the depicted IE may be associated with 3GPP Release 12 in various embodiments. However, the embodiments are not limited to this example.

In some embodiments, communications component 306 may be operative to send a UL message or signal based on the configuration information comprised in one or more configuration parameters 314. In various embodiments, communications component 306 may be operative to send a UL message or signal over a wireless channel based on configuration information comprised in a configuration parameter 314 associated with the wireless channel. For example, communications component 306 may be operative to send a UL message over a PUCCH of a small cell corresponding to cell identifier 312 based on configuration information comprised in a configuration parameter 314 associated with the PUCCH of the small cell. In some embodiments, communications component 306 may be operative to format a UL signal that it sends based on configuration information comprised in a configuration parameter 314 associated with the UL signal. For example, communications component 306 may be operative to format a periodic or aperiodic sounding reference signal (SRS) 316 that it sends based on

configuration information comprised in a configuration parameter 314 associated with the periodic or aperiodic SRS 316. The embodiments are not limited to these examples.

In various embodiments, communications component 306 may be operative to receive multiple UL communication process configuration messages 308, each corresponding to a  
5 respective UL communication process that has been configured for apparatus 300 and/or system 340. For example, in some embodiments, in addition to the UL communication process configuration message 308 that it receives from eNB 350, communications component 306 may be operative to receive a second UL communication process configuration message 308-2 from an eNB 360. In various embodiments, the eNB(s) that configure apparatus 300 and/or system  
10 340 with the multiple UL communication processes may utilize collision avoidance techniques to configure the multiple processes in such a way as to ensure that they will not collide. In some such embodiments, communications component 306 may be operative to perform UL communications based on an assumption that the processes defined by the multiple UL communication process configuration messages 308 will not collide. In various such  
15 embodiments, if a collision between UL communication processes does occur, communications component 306 may be operative to regard the collision as an error case. The embodiments are not limited in this context.

In some embodiments, rather than relying on collision avoidance on the eNB side, communications component 306 may be operative to apply one or more priority rules to handle  
20 collisions between UL communication processes. In various embodiments, in response to detecting a collision between two UL communication processes, communications component 306 may be operative to apply one or more such priority rules to select a UL communication process for which to drop some or all of a transmission. In some embodiments, communications component 306 may be operative to prioritize UL communication processes based on the cell  
25 types of the respective cells to which they correspond. For example, in various embodiments, communications component 306 may be operative to prioritize macrocell processes over small cell processes, or vice versa. In some embodiments, communications component 306 may be operative to prioritize UL communication processes based on the types of eNBs to which they correspond. For example, in various embodiments, communications component 306 may be  
30 operative to prioritize MeNB processes over SeNB processes, or vice versa. In some embodiments, communications component 306 may be operative to prioritize UL communication processes based on their UL process IDs. For example, in various embodiments, communications component 306 may be operative to prioritize UL communication processes with lower UL process IDs over those with higher UL process IDs, or vice versa. In some

embodiments, communications component 306 may additionally or alternatively be operative to prioritize UL communication processes based on priorities that are configured via radio resource control (RRC) signaling. The embodiments are not limited in this context.

In various embodiments, in order to select a specific transmission to partially or fully drop, communications component 306 may be operative to apply one or more content type-based priority rules. In some embodiments, communications component 306 may be operative to apply one or more content type-based priority rules to select from among multiple transmissions associated with a same UL communication process. In various embodiments, communications component 306 may additionally or alternatively be operative to apply one or more content type-based priority rules in conjunction with the determination of a UL communication processes for which a transmission is to be partially or fully dropped. In some embodiments, each content type-based priority rule may be usable to prioritize transmissions based on characteristics of the contents of those transmissions. In various embodiments, communications component 306 may be operative to prioritize transmissions based on the quality of service (QoS) levels associated with their contents. In some embodiments, communications component 306 may be operative to prioritize transmissions that contain channel state information (CSI) based on the types of CSI that they contain. For example, in various embodiments, communications component 306 may be operative to prioritize transmissions that contain CSI based on the CSI types defined in 3GPP TS 36.213. In a particular example, communications component 306 may be operative to assign a top level of priority to transmissions that contain CSI of types 3, 5, 6, or 2a, may be operative to assign a middle level of priority to transmissions that contain CSI of types 2, 2b, 2c, or 4, and may be operative to assign a bottom level of priority to transmissions that contain CSI of types 1 or 1a. In some embodiments, communications component 306 may be operative to prioritize transmissions based on their data/signal type. For example, in various embodiments, communications component 306 may be operative to prioritize UL control information (UCI) transmissions over data channel transmissions and/or SRS transmissions. It is to be understood that the embodiments are not limited to these examples.

In some embodiments, more than one of the aforementioned prioritization rules may be applied in combination. For example, in various embodiments, communications component 306 may be operative to prioritize among multiple CSI transmissions based on their CSI types, their associated cell indexes, and their associated UL process IDs. In various embodiments, for example, communications component 306 may be operative to prioritize among multiple CSI transmissions based first on their CSI types, second on their associated UL process IDs, and third on their associated cell indexes. As an additional example, in some other embodiments,

communications component 306 may be operative to prioritize among multiple CSI transmissions based first on their CSI types, second on their associated cell indexes, and third on their associated UL process IDs. It is to be appreciated that these criteria may be applied in any order, and the embodiments are not limited to the orders reflected in the previous two examples.

5 In some embodiments, if a particular prioritization criterion does not provide differentiation between the various transmissions being considered, it may be omitted from the prioritization. For example, communications component 306 may be operative to omit a process ID criterion when selecting from among transmissions that are all associated with a same UL communication process. In various embodiments, communications component 306 may be operative to utilize  
10 one or more default values when considering criteria for which values have not yet been generated and/or are not available. For example, when considering a transmission associated with a UL communication process for which a UL process ID is not available, communications component 306 may be operative to utilize a default UL process ID. The embodiments are not limited to these examples.

15 In some embodiments, communications component 306 may be operative to handle some process collisions at a configuration level. In various embodiments, communications component 306 may be operative to receive conflicting configuration parameters 314 associated with a same UL channel or signal. In some embodiments, communications component 306 may be operative to receive such conflicting configuration parameters 314 in different respective UL  
20 communication process configuration messages 308. In various other embodiments, communications component 306 may be operative to receive such conflicting configuration parameters 314 in a same UL communication process configuration message 308. In some embodiments, in order to resolve such a conflict, communications component 306 may be operative to disregard part or all of the configuration information comprised in one of the  
25 conflicting configuration parameters 314. The embodiments are not limited in this context.

In various embodiments, communications component 306 may be operative to implement UL power control for one or more UL channels and/or signals based on configuration information comprised in one or more configuration parameters 314. In some embodiments, for example, communications component 306 may be operative to determine transmit powers for  
30 PUSCH, PUCCH, and/or SRS transmissions according to the equations specified in sections 5.1.1.1, 5.1.2.1, and/or 5.1.3.1 of 3GPP TS 36.213. In various embodiments, a configuration parameter 314 that corresponds to a particular UL channel or signal may comprise the values needed to determine a transmit power for that UL channel or signal based on its corresponding equation. For example, a configuration parameter 314 that corresponds to a PUSCH of a small

cell may comprise the values needed to determine a transmit power for transmission over the PUSCH of the small cell via the equations specified in section 5.1.1.1 of 3GPP TS 36.213. In some embodiments, in conjunction with determining such UL transmit powers, a pathloss to the destination may be determined based on cell identifier 312. The embodiments are not limited in  
5 this context.

In various embodiments, communications component 306 may be operative to utilize information received in one or more UL communication process configuration messages 308 when performing power headroom (PH) reporting on behalf of apparatus 300 and/or system 340. In some embodiments, communications component 306 may be operative to perform a PH  
10 reporting procedure according to section 5.4.6 of 3GPP TS 36.321. In various embodiments, in conjunction with the PH reporting procedure, communications component 306 may be operative to determine a type 1 PH and/or a type 2 PH for any given serving cell of apparatus 300 and/or system 340. In some dual-connectivity embodiments, the received UL communication process configuration messages 308 may identify multiple serving cells for apparatus 300 and/or system  
15 340, and communications component 306 may be operative to determine respective type 1 and/or type 2 PHs for each of the multiple serving cells. In various embodiments, communications component 306 may be operative to send a respective PH report (PHR) 318 for each configured UL communication process regarding which it receives a UL communication process configuration message 308. In some embodiments, communications component 306  
20 may be operative to include PHs for multiple processes in a single PHR 318. In various embodiments, communications component 306 may be operative to include the UL process IDs 310 for the multiple processes in a media access control (MAC) element of the PHR 318.

In some embodiments, communications component 306 may be operative to determine the PH values that it includes in PHRs 318 based on the PUSCHs over which it sends those PHRs  
25 318. In various embodiments, when sending a PHR 318 over a given PUSCH, communications component 306 may be operative to identify a UL communication process corresponding to that PUSCH and to calculate a PH to include in the PHR 318 based only on power setting configurations associated with that UL communication process. In some embodiments, communications component 306 may be operative to send a PHR 318 whenever a pathloss  
30 associated with any UL communication process changes by more than a threshold. As such, in various embodiments, even when UL transmissions are distributed across multiple destination cells in time or involve concurrent transmission to multiple destination cells, proper PH values may be reported to the serving eNBs. The embodiments are not limited in this context.

In some embodiments, a common timing advance (TA) may be implemented for all the UL communication processes that are configured for apparatus 300 and/or system 340. In various other embodiments, different TAs may be implemented for different UL communication processes. In some such embodiments, the UL communication process configuration message 5 308 corresponding to any particular UL communication process may include a configuration parameter 314 specifying a configured TA for that process. In various embodiments, for example, a configuration parameter 314 that comprises an RRC parameter may be used to specify the configured TA for the corresponding process. In some dual-connectivity embodiments, an RRC parameter specifying TA type 0 may indicate that the corresponding 10 process has been configured with a TA that corresponds to a serving macrocell, while an RRC parameter specifying TA type 1 may indicate that the corresponding process has been configured with a TA that corresponds to a serving small cell. The embodiments are not limited to this example.

In various UE-CoMP embodiments, apparatus 300 and/or system 340 may utilize dynamic 15 or semi-static point selection, according to which it may be dynamically or semi-statically served by a small cell eNB and a macrocell eNB that operate on a same carrier frequency. In some such embodiments, communications component 306 may be operative to receive multiple UL communication process configuration messages 308 that correspond to UL channel/signal configurations for the multiple respective eNBs. In various embodiments, for example, 20 communications component 306 may be operative to receive a first UL communication process configuration message 308 that corresponds to a periodic CSI (pCSI) configuration for reporting pCSI 320 to the small cell eNB, and may be operative to receive a second UL communication process configuration message 308 that corresponds to a pCSI configuration for reporting pCSI 320 to the macrocell eNB. In some embodiments, each pCSI configuration may comprise and/or 25 specify a PUCCH format 2 resource, a reporting periodicity, a configuration offset, and/or one or more other parameters. In various embodiments, in order to initiate an adjustment of the transmission orientation of the small cell eNB, communications component 306 may be operative to send pCSI 320 for both the small cell and the macrocell. The embodiments are not limited in this context.

30 **FIG. 4** illustrates a block diagram of an apparatus 400. Apparatus 400 may be representative of an eNB that may configure UL communication processes in conjunction with UL communication techniques for non-ideal backhaul scenarios in some embodiments. For example, apparatus 400 may be representative of eNB 350 and/or eNB 360 of FIG. 3. As shown in FIG. 4, apparatus 400 comprises multiple elements including a processor circuit 402, a

memory unit 404, and a communications component 406. The embodiments, however, are not limited to the type, number, or arrangement of elements shown in this figure.

In some embodiments, apparatus 400 may comprise processor circuit 402. Processor circuit 402 may be implemented using any processor or logic device. Examples of processor  
5 circuit 402 may include, without limitation, any of the examples previously presented with respect to processor circuit 302 of FIG. 3. The embodiments are not limited in this context.

In various embodiments, apparatus 400 may comprise or be arranged to communicatively couple with a memory unit 404. Memory unit 404 may be implemented using any machine-readable or computer-readable media capable of storing data, including both volatile and non-  
10 volatile memory. Examples of memory unit 404 may include, without limitation, any of the examples previously presented with respect to memory unit 304 of FIG. 3. It is worthy of note that some portion or all of memory unit 404 may be included on the same integrated circuit as processor circuit 402, or alternatively some portion or all of memory unit 404 may be disposed on an integrated circuit or other medium, for example a hard disk drive, that is external to the  
15 integrated circuit of processor circuit 402. Although memory unit 404 is comprised within apparatus 400 in FIG. 4, memory unit 404 may be external to apparatus 400 in some embodiments. The embodiments are not limited in this context.

In various embodiments, apparatus 400 may comprise a communications component 406. Communications component 406 may comprise logic, circuitry, and/or instructions operative to  
20 send messages to one or more remote devices and/or to receive messages from one or more remote devices. In various embodiments, communications component 406 may be operative to send and/or receive messages over one or more wired connections, one or more wireless connections, or a combination of both. In some embodiments, communications component 406 may additionally comprise logic, circuitry, and/or instructions operative to perform various  
25 operations in support of such communications. Examples of such operations may include selection of transmission and/or reception parameters and/or timing, packet and/or protocol data unit (PDU) construction and/or deconstruction, encoding and/or decoding, error detection, and/or error correction. The embodiments are not limited to these examples.

In various embodiments, apparatus 400 may comprise a configuration component 422.  
30 Configuration component 422 may comprise logic, circuitry, and/or instructions operative to configure one or more UL communication processes for one or more UEs. In some embodiments, each UL communication process may define a configuration for one or more UL channels and/or signals used by one or more UEs. The embodiments are not limited in this context.

FIG. 4 also illustrates a block diagram of a system 440. System 440 may comprise any of the aforementioned elements of apparatus 400. System 440 may further comprise an RF transceiver 442. RF transceiver 442 may comprise one or more radios capable of transmitting and receiving signals using various suitable wireless communications techniques. Such techniques may involve communications across one or more wireless networks. Examples of such wireless networks may include, without limitation, any of the examples previously presented with respect to RF transceiver 342 of FIG. 3. In communicating across such networks, RF transceiver 442 may operate in accordance with one or more applicable standards in any version. The embodiments are not limited in this context.

In various embodiments, system 440 may comprise one or more RF antennas 444. Examples of RF antenna(s) 444 may include, without limitation, any of the examples previously presented with respect to RF antenna(s) 344 of FIG. 3. In various embodiments, RF transceiver 442 may be operative to send and/or receive messages and/or data using one or more RF antennas 444. The embodiments are not limited in this context.

Operations for the above embodiments may be further described with reference to the following figures and accompanying examples. Some of the figures may include a logic flow. Although such figures presented herein may include a particular logic flow, it can be appreciated that the logic flow merely provides an example of how the general functionality as described herein can be implemented. Further, the given logic flow does not necessarily have to be executed in the order presented unless otherwise indicated. In addition, the given logic flow may be implemented by a hardware element, a software element executed by a processor, or any combination thereof. The embodiments are not limited in this context.

In various embodiments, during operation of apparatus 400 and/or system 440, configuration component 422 may be operative to configure a UL communication process for a UE 470. In some dual-connectivity embodiments, apparatus 400 and/or system 440 an MeNB or an SeNB for the UE 470. In various embodiments, the configured UL communication process may be specific to the UE 470. In some other embodiments, the configured UL communication process may define a configuration that applies to other UEs in addition to the UE 470. In various embodiments, configuration component 422 may be operative to configure multiple UL communication processes for the UE 470, some, all, or none of which may apply to other UEs in addition to the UE 470. The embodiments are not limited in this context.

In some embodiments, for a given UL communication process that configuration component 422 has configured for UE 470, communications component 406 may be operative to generate a UL communication process configuration message 408. In various embodiments, UL

communication process configuration message 408 may be the same as or similar to UL communication process configuration message 308 of FIG. 3. In some embodiments, UL communication process configuration message 408 may comprise a defined information element. In various embodiments, UL communication process configuration message 408 may comprise a  
5 UL process ID 410. In some embodiments, UL process ID 410 may comprise a name, number, or other value that uniquely identifies the configured UL communication process to which UL communication process configuration message 408 corresponds. In various embodiments, UL communication process configuration message 408 may comprise a cell identifier 412. In some  
10 embodiments, cell identifier 412 may identify a cell or cell sector with which the UL communication process described by UL communication process configuration message 408 is associated. In various embodiments, that cell or cell sector may comprise a cell or cell sector that is served by apparatus 400 and/or system 440. The embodiments are not limited in this context.

In some embodiments, UL communication process configuration message 408 may  
15 comprise one or more configuration parameters 414. In various embodiments, some or all of configuration parameters 414 may correspond to particular respective UL channels or signals, and may comprise configuration information applicable to communications by UE 470 via those respective UL channels or signals. In some embodiments, one or more configuration parameters 414 may not correspond to particular UL channels or signals, but rather may correspond to  
20 particular UL transmission parameters. For example, in various embodiments, a given configuration parameter 414 may comprise configuration information that is applicable to UL power control operations on the part of UE 470. In some embodiments, one or more configuration parameters 414 may comprise UE-specific parameters that are specific to UE 470. In various embodiments, one or more configuration parameters 414 may additionally or  
25 alternatively comprise cell-specific parameters that are specific to UL communications within a cell or cell sector specified by cell identifier 412. The embodiments are not limited in this context.

In some embodiments, in conjunction with configuring any particular UL communication process for UE 470 and/or one or more other UEs, configuration component 422 may be  
30 operative to implement one or more collision avoidance techniques to prevent that UL communication process from colliding with other configured UL communication processes. In various such embodiments, communications component 406 may be operative to communicate with one or more remote devices such as eNBs to enable configuration component 422 to coordinate the UL communication processes that it configures with those configured by the one

or more remote devices. In an example embodiment, in conjunction with configuring a UL communication process for UE 470, configuration component 422 may be operative to coordinate with an eNB 460 that configures a second UL communication process for UE 470. In some embodiments, communications component 406 may be operative to receive control  
5 information from eNB 460 over a non-ideal backhaul and/or to send control information to eNB 460 over the non-ideal backhaul. In various embodiments, following respective transmissions of corresponding UL communication process configuration messages 408 and 408-2 to UE 470, UE 470 may proceed with UL communications based on an assumption that the configured processes will not collide. In some embodiments, configuration component 422 may be  
10 operative to implement collision avoidance techniques to prevent collisions between multiple UL communications processes that it configures itself. In various embodiments, configuration component 422 may additionally or alternatively be operative to implement collision avoidance techniques to prevent collisions among a set of configuration parameters 414 defined by a same UL communication process configuration. The embodiments are not limited in this context.

15 In some embodiments, apparatus 400 and/or system 440 may be operative to utilize its ability to configure UL communication processes for UE 470 and/or one or more other UEs to implement one-way Coordinated Scheduling/Coordinated Beamforming (CS/CB) CoMP coordination. In various embodiments, apparatus 400 and/or system 440 may comprise an aggressor eNB that performs long-term interference avoidance in the spatial domain towards  
20 cell-edge UEs of a victim eNB for some semi-statically configured time or frequency resources. In some embodiments, eNB 460 may comprise a victim eNB with respect to apparatus 400 and/or system 440, and UE 470 may comprise a cell-edge UE of eNB 460. In various embodiments, apparatus 400 and/or system 440, eNB 460, and UE 470 may be comprised in a heterogeneous network (HetNet) environment. In some embodiments, the HetNet environment  
25 may reflect a co-channel small cell deployment scenario. In various embodiments, communications component 406 may be operative to obtain CSI information 424 associated with such cell-edge UEs from the victim eNB. In some embodiments, the CSI information 424 may include precoding matrix indicators (PMIs) and/or rank indications (RIs). In various embodiments, communications component 406 may be operative to receive the CSI information  
30 424 periodically, aperiodically, or both. In some embodiments, communications component 406 may be operative to receive the CSI information 424 from the victim eNB over a non-ideal backhaul. In various embodiments, configuration component 422 may be operative to select time and/or frequency resources for which to perform long-term interference avoidance based on the CSI information 424. In some embodiments, communications component 406 may be

operative to send beamforming nulling information 424 that identifies those time and/or frequency resources to the victim eNB. In various embodiments, communications component 406 may be operative to send the beamforming nulling information 424 in a beamforming nulling assignment. The victim eNB may consider the received beamforming nulling information 424 in conjunction with performing user scheduling operations. The embodiments are not limited in this context.

**FIG. 5** illustrates an embodiment of a logic flow 500, which may be representative of the operations executed by one or more embodiments described herein. For example, logic flow 500 may be representative of operations that may be executed in some embodiments by apparatus 300 and/or system 340 of FIG. 3. As shown in logic flow 500, a UL communication process configuration IE may be received at 502 that comprises a cell index and one or more configuration parameters. For example, communications component 306 of FIG. 3 may be operative to receive a UL communication process configuration message 308 from eNB 350 that includes a cell identifier 312 comprising a cell index and includes one or more configuration parameters 314. At 504, a pathloss to an eNB may be determined based on the cell index. For example, communications component 306 of FIG. 3 may be operative to determine a pathloss to eNB 350 based on cell identifier 312. At 506, a wireless signal may be transmitted based on at least one of the one or more configuration parameters. For example, communications component 306 of FIG. 3 may be operative to transmit a wireless signal based on one or more configuration parameters 314. The embodiments are not limited to these examples.

**FIG. 6** illustrates an embodiment of a logic flow 600, which may be representative of the operations executed by one or more embodiments described herein. For example, logic flow 600 may be representative of operations that may be executed in various embodiments by apparatus 400 and/or system 440 of FIG. 4. As shown in logic flow 600, a UL communication process may be configured for at least one UE at 602. For example, configuration component 422 of FIG. 4 may be operative to configure a UL communication process for UE 470 and/or one or more other UEs. At 604, a UL communication process IE may be generated that describes the UL communication process configured at 602. For example, communications component 406 of FIG. 4 may be operative to generate a UL communication process configuration message 408 comprising an IE that describes a UL communication process configured by configuration component 422. At 606, the UL communication process IE may be transmitted over a wireless channel. For example, apparatus 400 and/or system 440 of FIG. 4 may be operative to transmit UL communication process configuration message 408 to UE 470 and/or to one or more other UEs over a wireless channel. The embodiments are not limited to these examples.

**FIG. 7** illustrates an embodiment of a logic flow 700, which may be representative of the operations executed by one or more embodiments described herein. For example, logic flow 700 may be representative of operations that may be executed in some embodiments by apparatus 400 and/or system 440 of FIG. 4. As shown in logic flow 700, CSI for at least one UE may be received over a non-ideal backhaul at 702. For example, communications component 406 of FIG. 4 may be operative to receive CSI information 424 from eNB 460 over a non-ideal backhaul. At 704, one or more resources for which to perform long-term interference avoidance may be selected based on the CSI. For example, configuration component 422 of FIG. 4 may be operative to select one or more time and/or frequency resources for which to perform long-term interference avoidance with respect to eNB 460, based on CSI information 424. At 706, a beamforming nulling assignment may be sent that identifies the one or more selected resources. For example, communications component 406 of FIG. 4 may be operative to send beamforming nulling information 426 to eNB 460. The embodiments are not limited to these examples.

**FIG. 8** illustrates an embodiment of a storage medium 800. Storage medium 800 may comprise any non-transitory computer-readable storage medium or machine-readable storage medium, such as an optical, magnetic or semiconductor storage medium. In various embodiments, storage medium 800 may comprise an article of manufacture. In some embodiments, storage medium 800 may store computer-executable instructions, such as computer-executable instructions to implement one or more of logic flow 500 of FIG. 5, logic flow 600 of FIG. 6, and logic flow 700 of FIG. 7. Examples of a computer-readable storage medium or machine-readable storage medium may include any tangible media capable of storing electronic data, including volatile memory or non-volatile memory, removable or non-removable memory, erasable or non-erasable memory, writeable or re-writeable memory, and so forth. Examples of computer-executable instructions may include any suitable type of code, such as source code, compiled code, interpreted code, executable code, static code, dynamic code, object-oriented code, visual code, and the like. The embodiments are not limited in this context.

**FIG. 9** illustrates an embodiment of a communications device 900 that may implement one or more of apparatus 300 and/or system 340 of FIG. 3, apparatus 400 and/or system 440 of FIG. 4, logic flow 500 of FIG. 5, logic flow 600 of FIG. 6, logic flow 700 of FIG. 7, and storage medium 800 of FIG. 8. In various embodiments, device 900 may comprise a logic circuit 928. The logic circuit 928 may include physical circuits to perform operations described for one or more of apparatus 300 and/or system 340 of FIG. 3, apparatus 400 and/or system 440 of FIG. 4, logic flow 500 of FIG. 5, logic flow 600 of FIG. 6, and logic flow 700 of FIG. 7, for example.

As shown in FIG. 9, device 900 may include a radio interface 910, baseband circuitry 920, and computing platform 930, although the embodiments are not limited to this configuration.

The device 900 may implement some or all of the structure and/or operations for one or more of apparatus 300 and/or system 340 of FIG. 3, apparatus 400 and/or system 440 of FIG. 4, 5 logic flow 500 of FIG. 5, logic flow 600 of FIG. 6, logic flow 700 of FIG. 7, storage medium 800 of FIG. 8, and logic circuit 928 in a single computing entity, such as entirely within a single device. Alternatively, the device 900 may distribute portions of the structure and/or operations for one or more of apparatus 300 and/or system 340 of FIG. 3, apparatus 400 and/or system 440 of FIG. 4, logic flow 500 of FIG. 5, logic flow 600 of FIG. 6, logic flow 700 of FIG. 7, storage 10 medium 800 of FIG. 8, and logic circuit 928 across multiple computing entities using a distributed system architecture, such as a client-server architecture, a 3-tier architecture, an N-tier architecture, a tightly-coupled or clustered architecture, a peer-to-peer architecture, a master-slave architecture, a shared database architecture, and other types of distributed systems. The embodiments are not limited in this context.

15 In one embodiment, radio interface 910 may include a component or combination of components adapted for transmitting and/or receiving single-carrier or multi-carrier modulated signals (e.g., including complementary code keying (CCK), orthogonal frequency division multiplexing (OFDM), and/or single-carrier frequency division multiple access (SC-FDMA) symbols) although the embodiments are not limited to any specific over-the-air interface or 20 modulation scheme. Radio interface 910 may include, for example, a receiver 912, a frequency synthesizer 914, and/or a transmitter 916. Radio interface 910 may include bias controls, a crystal oscillator and/or one or more antennas 918-*f*. In another embodiment, radio interface 910 may use external voltage-controlled oscillators (VCOs), surface acoustic wave filters, intermediate frequency (IF) filters and/or RF filters, as desired. Due to the variety of potential 25 RF interface designs an expansive description thereof is omitted.

Baseband circuitry 920 may communicate with radio interface 910 to process receive and/or transmit signals and may include, for example, an analog-to-digital converter 922 for down converting received signals, a digital-to-analog converter 924 for up converting signals for transmission. Further, baseband circuitry 920 may include a baseband or physical layer (PHY) 30 processing circuit 926 for PHY link layer processing of respective receive/transmit signals. Baseband circuitry 920 may include, for example, a medium access control (MAC) processing circuit 927 for MAC/data link layer processing. Baseband circuitry 920 may include a memory controller 932 for communicating with MAC processing circuit 927 and/or a computing platform 930, for example, via one or more interfaces 934.

In some embodiments, PHY processing circuit 926 may include a frame construction and/or detection module, in combination with additional circuitry such as a buffer memory, to construct and/or deconstruct communication frames. Alternatively or in addition, MAC processing circuit 927 may share processing for certain of these functions or perform these processes independent of PHY processing circuit 926. In some embodiments, MAC and PHY processing may be integrated into a single circuit.

The computing platform 930 may provide computing functionality for the device 900. As shown, the computing platform 930 may include a processing component 940. In addition to, or alternatively of, the baseband circuitry 920, the device 900 may execute processing operations or logic for one or more of apparatus 300 and/or system 340 of FIG. 3, apparatus 400 and/or system 440 of FIG. 4, logic flow 500 of FIG. 5, logic flow 600 of FIG. 6, logic flow 700 of FIG. 7, storage medium 800 of FIG. 8, and logic circuit 928 using the processing component 940. The processing component 940 (and/or PHY 926 and/or MAC 927) may comprise various hardware elements, software elements, or a combination of both. Examples of hardware elements may include devices, logic devices, components, processors, microprocessors, circuits, processor circuits, circuit elements (e.g., transistors, resistors, capacitors, inductors, and so forth), integrated circuits, application specific integrated circuits (ASIC), programmable logic devices (PLD), digital signal processors (DSP), field programmable gate array (FPGA), memory units, logic gates, registers, semiconductor device, chips, microchips, chip sets, and so forth. Examples of software elements may include software components, programs, applications, computer programs, application programs, system programs, software development programs, machine programs, operating system software, middleware, firmware, software modules, routines, subroutines, functions, methods, procedures, software interfaces, application program interfaces (API), instruction sets, computing code, computer code, code segments, computer code segments, words, values, symbols, or any combination thereof. Determining whether an embodiment is implemented using hardware elements and/or software elements may vary in accordance with any number of factors, such as desired computational rate, power levels, heat tolerances, processing cycle budget, input data rates, output data rates, memory resources, data bus speeds and other design or performance constraints, as desired for a given implementation.

The computing platform 930 may further include other platform components 950. Other platform components 950 include common computing elements, such as one or more processors, multi-core processors, co-processors, memory units, chipsets, controllers, peripherals, interfaces, oscillators, timing devices, video cards, audio cards, multimedia input/output (I/O) components (e.g., digital displays), power supplies, and so forth. Examples of memory units may include

without limitation various types of computer readable and machine readable storage media in the form of one or more higher speed memory units, such as read-only memory (ROM), random-access memory (RAM), dynamic RAM (DRAM), Double-Data-Rate DRAM (DDRAM), synchronous DRAM (SDRAM), static RAM (SRAM), programmable ROM (PROM), erasable programmable ROM (EPROM), electrically erasable programmable ROM (EEPROM), flash memory, polymer memory such as ferroelectric polymer memory, ovonic memory, phase change or ferroelectric memory, silicon-oxide-nitride-oxide-silicon (SONOS) memory, magnetic or optical cards, an array of devices such as Redundant Array of Independent Disks (RAID) drives, solid state memory devices (e.g., USB memory, solid state drives (SSD) and any other type of storage media suitable for storing information.

Device 900 may be, for example, an ultra-mobile device, a mobile device, a fixed device, a machine-to-machine (M2M) device, a personal digital assistant (PDA), a mobile computing device, a smart phone, a telephone, a digital telephone, a cellular telephone, user equipment, eBook readers, a handset, a one-way pager, a two-way pager, a messaging device, a computer, a personal computer (PC), a desktop computer, a laptop computer, a notebook computer, a netbook computer, a handheld computer, a tablet computer, a server, a server array or server farm, a web server, a network server, an Internet server, a work station, a mini-computer, a main frame computer, a supercomputer, a network appliance, a web appliance, a distributed computing system, multiprocessor systems, processor-based systems, consumer electronics, programmable consumer electronics, game devices, display, television, digital television, set top box, wireless access point, base station, node B, subscriber station, mobile subscriber center, radio network controller, router, hub, gateway, bridge, switch, machine, or combination thereof. Accordingly, functions and/or specific configurations of device 900 described herein, may be included or omitted in various embodiments of device 900, as suitably desired.

Embodiments of device 900 may be implemented using single input single output (SISO) architectures. However, certain implementations may include multiple antennas (e.g., antennas 918-f) for transmission and/or reception using adaptive antenna techniques for beamforming or spatial division multiple access (SDMA) and/or using MIMO communication techniques.

The components and features of device 900 may be implemented using any combination of discrete circuitry, application specific integrated circuits (ASICs), logic gates and/or single chip architectures. Further, the features of device 900 may be implemented using microcontrollers, programmable logic arrays and/or microprocessors or any combination of the foregoing where suitably appropriate. It is noted that hardware, firmware and/or software elements may be collectively or individually referred to herein as “logic” or “circuit.”

It should be appreciated that the exemplary device 900 shown in the block diagram of FIG. 9 may represent one functionally descriptive example of many potential implementations. Accordingly, division, omission or inclusion of block functions depicted in the accompanying figures does not infer that the hardware components, circuits, software and/or elements for implementing these functions would be necessarily be divided, omitted, or included in  
5 embodiments.

**FIG. 10** illustrates an embodiment of a broadband wireless access system 1000. As shown in FIG. 10, broadband wireless access system 1000 may be an internet protocol (IP) type network comprising an internet 1010 type network or the like that is capable of supporting  
10 mobile wireless access and/or fixed wireless access to internet 1010. In one or more embodiments, broadband wireless access system 1000 may comprise any type of orthogonal frequency division multiple access (OFDMA)-based or single-carrier frequency division multiple access (SC-FDMA)-based wireless network, such as a system compliant with one or more of the 3GPP LTE Specifications and/or IEEE 802.16 Standards, and the scope of the claimed subject  
15 matter is not limited in these respects.

In the exemplary broadband wireless access system 1000, radio access networks (RANs) 1012 and 1018 are capable of coupling with evolved node Bs (eNBs) 1014 and 1020, respectively, to provide wireless communication between one or more fixed devices 1016 and internet 1010 and/or between one or more mobile devices 1022 and Internet 1010. One  
20 example of a fixed device 1016 and a mobile device 1022 is device 900 of FIG. 9, with the fixed device 1016 comprising a stationary version of device 900 and the mobile device 1022 comprising a mobile version of device 900. RANs 1012 and 1018 may implement profiles that are capable of defining the mapping of network functions to one or more physical entities on broadband wireless access system 1000. eNBs 1014 and 1020 may comprise radio equipment to  
25 provide RF communication with fixed device 1016 and/or mobile device 1022, such as described with reference to device 900, and may comprise, for example, the PHY and MAC layer equipment in compliance with a 3GPP LTE Specification or an IEEE 802.16 Standard. eNBs 1014 and 1020 may further comprise an IP backplane to couple to Internet 1010 via RANs 1012 and 1018, respectively, although the scope of the claimed subject matter is not limited in these  
30 respects.

Broadband wireless access system 1000 may further comprise a visited core network (CN) 1024 and/or a home CN 1026, each of which may be capable of providing one or more network functions including but not limited to proxy and/or relay type functions, for example authentication, authorization and accounting (AAA) functions, dynamic host configuration

protocol (DHCP) functions, or domain name service controls or the like, domain gateways such as public switched telephone network (PSTN) gateways or voice over internet protocol (VoIP) gateways, and/or internet protocol (IP) type server functions, or the like. However, these are merely example of the types of functions that are capable of being provided by visited CN 1024  
5 and/or home CN 1026, and the scope of the claimed subject matter is not limited in these respects. Visited CN 1024 may be referred to as a visited CN in the case where visited CN 1024 is not part of the regular service provider of fixed device 1016 or mobile device 1022, for example where fixed device 1016 or mobile device 1022 is roaming away from its respective home CN 1026, or where broadband wireless access system 1000 is part of the regular service  
10 provider of fixed device 1016 or mobile device 1022 but where broadband wireless access system 1000 may be in another location or state that is not the main or home location of fixed device 1016 or mobile device 1022. The embodiments are not limited in this context.

Fixed device 1016 may be located anywhere within range of one or both of eNBs 1014 and 1020, such as in or near a home or business to provide home or business customer broadband  
15 access to Internet 1010 via eNBs 1014 and 1020 and RANs 1012 and 1018, respectively, and home CN 1026. It is worthy of note that although fixed device 1016 is generally disposed in a stationary location, it may be moved to different locations as needed. Mobile device 1022 may be utilized at one or more locations if mobile device 1022 is within range of one or both of eNBs 1014 and 1020, for example. In accordance with one or more embodiments, operation support  
20 system (OSS) 1028 may be part of broadband wireless access system 1000 to provide management functions for broadband wireless access system 1000 and to provide interfaces between functional entities of broadband wireless access system 1000. Broadband wireless access system 1000 of FIG. 10 is merely one type of wireless network showing a certain number of the components of broadband wireless access system 1000, and the scope of the claimed  
25 subject matter is not limited in these respects.

Various embodiments may be implemented using hardware elements, software elements, or a combination of both. Examples of hardware elements may include processors, microprocessors, circuits, circuit elements (e.g., transistors, resistors, capacitors, inductors, and so forth), integrated circuits, application specific integrated circuits (ASIC), programmable logic  
30 devices (PLD), digital signal processors (DSP), field programmable gate array (FPGA), logic gates, registers, semiconductor device, chips, microchips, chip sets, and so forth. Examples of software may include software components, programs, applications, computer programs, application programs, system programs, machine programs, operating system software, middleware, firmware, software modules, routines, subroutines, functions, methods, procedures,

software interfaces, application program interfaces (API), instruction sets, computing code, computer code, code segments, computer code segments, words, values, symbols, or any combination thereof. Determining whether an embodiment is implemented using hardware elements and/or software elements may vary in accordance with any number of factors, such as  
5 desired computational rate, power levels, heat tolerances, processing cycle budget, input data rates, output data rates, memory resources, data bus speeds and other design or performance constraints.

One or more aspects of at least one embodiment may be implemented by representative instructions stored on a machine-readable medium which represents various logic within the  
10 processor, which when read by a machine causes the machine to fabricate logic to perform the techniques described herein. Such representations, known as “IP cores” may be stored on a tangible, machine readable medium and supplied to various customers or manufacturing facilities to load into the fabrication machines that actually make the logic or processor. Some embodiments may be implemented, for example, using a machine-readable medium or article  
15 which may store an instruction or a set of instructions that, if executed by a machine, may cause the machine to perform a method and/or operations in accordance with the embodiments. Such a machine may include, for example, any suitable processing platform, computing platform, computing device, processing device, computing system, processing system, computer, processor, or the like, and may be implemented using any suitable combination of hardware  
20 and/or software. The machine-readable medium or article may include, for example, any suitable type of memory unit, memory device, memory article, memory medium, storage device, storage article, storage medium and/or storage unit, for example, memory, removable or non-removable media, erasable or non-erasable media, writeable or re-writable media, digital or analog media, hard disk, floppy disk, Compact Disk Read Only Memory (CD-ROM), Compact  
25 Disk Recordable (CD-R), Compact Disk Rewriteable (CD-RW), optical disk, magnetic media, magneto-optical media, removable memory cards or disks, various types of Digital Versatile Disk (DVD), a tape, a cassette, or the like. The instructions may include any suitable type of code, such as source code, compiled code, interpreted code, executable code, static code, dynamic code, encrypted code, and the like, implemented using any suitable high-level, low-  
30 level, object-oriented, visual, compiled and/or interpreted programming language.

The following examples pertain to further embodiments:

Example 1 is user equipment (UE), comprising logic, at least a portion of which is in hardware, the logic to receive an uplink (UL) communication process configuration message identifying a configured UL communication process for the UE, the UL communication process

configuration message comprising a cell identifier and one or more configuration information elements (IEs), each configuration IE comprising configuration information for UL communications on the part of the UE, the logic to send a UL message based on the configuration information comprised in at least one of the configuration IEs.

5           In Example 2, the logic of Example 1 may optionally determine a pathloss to an evolved node B (eNB) corresponding to the cell identifier.

          In Example 3, the logic of any of Examples 1 to 2 may optionally send the UL message in a dual-connectivity operation mode based on the configuration information comprised in at least one of the configuration IEs.

10           In Example 4, the logic of any of Examples 1 to 2 may optionally send the UL message in a UL coordinated multipoint (UL-CoMP) operation mode based on the configuration information comprised in at least one of the configuration IEs.

          In Example 5, the one or more configuration IEs of any of Examples 1 to 4 may optionally include at least one configuration IE comprising configuration information for communications  
15           on the part of the UE over a wireless channel of a cell corresponding to the cell identifier.

          In Example 6, the wireless channel of Example 5 may optionally comprise a physical uplink control channel (PUCCH), a physical uplink shared channel (PUSCH), or a random access channel (RACH).

          In Example 7, the one or more configuration IEs of any of Examples 1 to 6 may optionally  
20           include at least one configuration IE comprising configuration information for a sounding reference signal (SRS) of the UE.

          In Example 8, the logic of any of Examples 1 to 7 may optionally apply one or more priority rules to resolve a collision between multiple UL communication processes that have been configured for the UE.

25           Example 9 is a system, comprising a UE according to any of Examples 1 to 8, a radio frequency (RF) transceiver, one or more RF antennas, and a display.

          Example 10 is at least one non-transitory computer-readable storage medium comprising a set of wireless communication instructions that, in response to being executed at an evolved node B (eNB), cause the eNB to configure an uplink (UL) communication process for at least one user  
30           equipment (UE), generate a UL communication process information element (IE) that describes the UL communication process, the UL communication process IE comprising a cell index for a cell served by the eNB and at least one configuration parameter comprising configuration information for a UL channel of the cell, and transmit the UL communication process IE over a wireless channel.

In Example 11, the at least one non-transitory computer-readable storage medium of Example 10 may optionally comprise wireless communication instructions that, in response to being executed at the eNB, cause the eNB to receive control information over a non-ideal backhaul, and configure the UL communication process based on the control information.

5 In Example 12, the at least one non-transitory computer-readable storage medium of Example 11 may optionally comprise wireless communication instructions that, in response to being executed at the eNB, cause the eNB to receive channel state information (CSI) for the at least one UE over the non-ideal backhaul.

10 In Example 13, the at least one non-transitory computer-readable storage medium of Example 12 may optionally comprise wireless communication instructions that, in response to being executed at the eNB, cause the eNB to select one or more resources for which to perform long-term interference avoidance based on the CSI, and send a beamforming nulling assignment that identifies the one or more selected resources.

15 In Example 14, the UL channel of any of Examples 10 to 13 may optionally comprise a physical uplink control channel (PUCCH), a physical uplink shared channel (PUSCH), or a random access channel (RACH).

In Example 15, the UL communication process IE of any of Examples 10 to 14 may optionally include a configuration parameter comprising configuration information for a sounding reference signal (SRS).

20 In Example 16, the at least one non-transitory computer-readable storage medium of any of Examples 10 to 15 may optionally comprise wireless communication instructions that, in response to being executed at the eNB, cause the eNB to implement one or more collision avoidance techniques in conjunction with configuring the UL communication process.

25 In Example 17, the at least one configuration parameter of any of Examples 10 to 16 may optionally comprise configuration information that applies to a plurality of cells.

30 Example 18 is a wireless communication method, comprising receiving an uplink (UL) communication process configuration information element (IE) describing a configured UL communication process for a UE, the UL communication process configuration IE comprising a cell index and one or more configuration parameters, each configuration IE comprising configuration information for UL communications on the part of the UE, determining, by a processor circuit, a pathloss to an evolved node B (eNB) based on the cell index, and transmitting a wireless signal based on at least one of the one or more configuration parameters.

In Example 19, the eNB of Example 18 may optionally comprise a master eNB (MeNB) of a master cell group (MCG).

In Example 20, the eNB of Example 18 may optionally comprise a secondary eNB (SeNB) of a secondary cell group (SCG).

In Example 21, the wireless communication method of any of Examples 18 to 20 may optionally comprise transmitting the wireless signal while operating in a dual-connectivity mode.

5 In Example 22, the wireless communication method of any of Examples 18 to 20 may optionally comprise transmitting the wireless signal while operating in a UL coordinated multipoint (UL-CoMP) mode.

In Example 23, the wireless signal of any of Examples 18 to 22 may optionally comprise a periodic sounding reference signal (SRS) or an aperiodic SRS.

10 In Example 24, the one or more configuration parameters of any of Examples 18 to 23 may optionally include at least one UE-specific configuration parameter.

In Example 25, the one or more configuration parameters of any of Examples 18 to 24 may optionally include at least one configuration parameter comprising configuration information for a plurality of UEs.

15 Example 26 is at least one non-transitory computer-readable storage medium comprising a set of instructions that, in response to being executed on a computing device, cause the computing device to perform a wireless communication method according to any of Examples 18 to 25.

20 Example 27 is an apparatus, comprising means for performing a wireless communication method according to any of Examples 18 to 25.

Example 28 is a system, comprising an apparatus according to Example 27, a radio frequency (RF) transceiver, one or more RF antennas, and a display.

25 Example 29 is an evolved node B (eNB), comprising logic, at least a portion of which is in hardware, the logic to configure an uplink (UL) communication process for at least one user equipment (UE) and generate a UL communication process information element (IE) that describes the UL communication process, the UL communication process IE comprising a cell index for a cell served by the eNB and at least one configuration parameter comprising configuration information for a UL channel of the cell, and a radio frequency (RF) transceiver to transmit the UL communication process IE over a wireless channel.

30 In Example 30, the logic of Example 29 may optionally receive control information over a non-ideal backhaul and configure the UL communication process based on the control information.

In Example 31, the logic of Example 30 may optionally receive channel state information (CSI) for the at least one UE over the non-ideal backhaul.

In Example 32, the logic of Example 31 may optionally select one or more resources for which to perform long-term interference avoidance based on the CSI and send a beamforming nulling assignment that identifies the one or more selected resources.

5 In Example 33, the UL channel of any of Examples 29 to 32 may optionally comprise a physical uplink control channel (PUCCH), a physical uplink shared channel (PUSCH), or a random access channel (RACH).

In Example 34, the UL communication process IE of any of Examples 29 to 33 may optionally include a configuration parameter comprising configuration information for a sounding reference signal (SRS).

10 In Example 35, the logic of any of Examples 29 to 34 may optionally implement one or more collision avoidance techniques in conjunction with configuring the UL communication process.

In Example 36, the at least one configuration parameter of any of Examples 29 to 35 may optionally comprise configuration information that applies to a plurality of cells.

15 Example 37 is an eNB according to any of Examples 29 to 36, comprising a radio frequency (RF) transceiver, and one or more RF antennas.

Example 38 is at least one non-transitory computer-readable storage medium comprising a set of wireless communication instructions that, in response to being executed at user equipment (UE), cause the UE to receive an uplink (UL) communication process configuration information element (IE) describing a configured UL communication process for the UE, the UL  
20 communication process configuration IE comprising a cell index and one or more configuration parameters, each configuration IE comprising configuration information for UL communications on the part of the UE, determine a pathloss to an evolved node B (eNB) based on the cell index, and transmit a wireless signal based on at least one of the one or more configuration parameters.

25 In Example 39, the eNB of Example 38 may optionally comprise a master eNB (MeNB) of a master cell group (MCG).

In Example 40, the eNB of Example 38 may optionally comprise a secondary eNB (SeNB) of a secondary cell group (SCG).

30 In Example 41, the at least one non-transitory computer-readable storage medium of any of Examples 38 to 40 may optionally comprise wireless communication instructions that, in response to being executed at the UE, cause the UE to transmit the wireless signal while operating in a dual-connectivity mode.

In Example 42, the at least one non-transitory computer-readable storage medium of any of Examples 38 to 40 may optionally comprise wireless communication instructions that, in

response to being executed at the UE, cause the UE to transmit the wireless signal while operating in a UL coordinated multipoint (UL-CoMP) mode.

In Example 43, the wireless signal of any of Examples 38 to 42 may optionally comprise a periodic sounding reference signal (SRS) or an aperiodic SRS.

5 In Example 44, the one or more configuration parameters of any of Examples 38 to 43 may optionally include at least one UE-specific configuration parameter.

In Example 45, the one or more configuration parameters of any of Examples 38 to 44 may optionally include at least one configuration parameter comprising configuration information for a plurality of UEs.

10 Example 46 is a wireless communication method, comprising receiving, at user equipment (UE), an uplink (UL) communication process configuration message identifying a configured UL communication process for the UE, the UL communication process configuration message comprising a cell identifier and one or more configuration information elements (IEs), each configuration IE comprising configuration information for UL communications on the part of the  
15 UE, and sending, by a radio frequency (RF) transceiver, a UL message based on the configuration information comprised in at least one of the configuration IEs.

In Example 47, the wireless communication method of Example 46 may optionally comprise determining a pathloss to an evolved node B (eNB) corresponding to the cell identifier.

20 In Example 48, the wireless communication method of any of Examples 46 to 47 may optionally comprise sending the UL message in a dual-connectivity operation mode based on the configuration information comprised in at least one of the configuration IEs.

In Example 49, the wireless communication method of any of Examples 46 to 47 may optionally comprise sending the UL message in a UL coordinated multipoint (UL-CoMP) operation mode based on the configuration information comprised in at least one of the  
25 configuration IEs.

In Example 50, the one or more configuration IEs of any of Examples 46 to 49 may optionally include at least one configuration IE comprising configuration information for communications on the part of the UE over a wireless channel of a cell corresponding to the cell identifier.

30 In Example 51, the wireless channel of Example 50 may optionally comprise a physical uplink control channel (PUCCH), a physical uplink shared channel (PUSCH), or a random access channel (RACH).

In Example 52, the one or more configuration IEs of any of Examples 46 to 51 may optionally include at least one configuration IE comprising configuration information for a sounding reference signal (SRS) of the UE.

5 In Example 53, the wireless communication method of any of Examples 46 to 52 may optionally comprise applying one or more priority rules to resolve a collision between multiple UL communication processes that have been configured for the UE.

Example 54 is at least one non-transitory computer-readable storage medium comprising a set of instructions that, in response to being executed on a computing device, cause the computing device to perform a wireless communication method according to any of Examples  
10 46 to 53.

Example 55 is an apparatus, comprising means for performing a wireless communication method according to any of Examples 46 to 53.

Example 56 is a system, comprising an apparatus according to Example 55, a radio frequency (RF) transceiver, one or more RF antennas, and a display.

15 Example 57 is user equipment (UE), comprising logic, at least a portion of which is in hardware, the logic to receive an uplink (UL) communication process configuration information element (IE) describing a configured UL communication process for the UE, the UL communication process configuration IE comprising a cell index and one or more configuration parameters, each configuration IE comprising configuration information for UL communications  
20 on the part of the UE, the logic to determine a pathloss to an evolved node B (eNB) based on the cell index and send a wireless signal based on at least one of the one or more configuration parameters.

In Example 58, the eNB of Example 57 may optionally comprise a master eNB (MeNB) of a master cell group (MCG).

25 In Example 59, the eNB of Example 57 may optionally comprise a secondary eNB (SeNB) of a secondary cell group (SCG).

In Example 60, the logic of any of Examples 57 to 59 may optionally send the wireless signal while operating in a dual-connectivity mode.

30 In Example 61, the logic of any of Examples 57 to 59 may optionally send the wireless signal while operating in a UL coordinated multipoint (UL-CoMP) mode.

In Example 62, the wireless signal of any of Examples 57 to 61 may optionally comprise a periodic sounding reference signal (SRS) or an aperiodic SRS.

In Example 63, the one or more configuration parameters of any of Examples 57 to 62 may optionally include at least one UE-specific configuration parameter.

In Example 64, the one or more configuration parameters of any of Examples 57 to 63 may optionally include at least one configuration parameter comprising configuration information for a plurality of UEs.

5 Example 65 is a system, comprising a UE according to any of Examples 57 to 64, a radio frequency (RF) transceiver, one or more RF antennas, and a display.

Example 66 is at least one non-transitory computer-readable storage medium comprising a set of wireless communication instructions that, in response to being executed on a computing device, cause the computing device to receive an uplink (UL) communication process configuration message identifying a configured UL communication process for a user equipment 10 (UE), the UL communication process configuration message comprising a cell identifier and one or more configuration information elements (IEs), each configuration IE comprising configuration information for UL communications on the part of the UE, and send a UL message based on the configuration information comprised in at least one of the configuration IEs.

15 In Example 67, the at least one non-transitory computer-readable storage medium of Example 66 may optionally comprise wireless communication instructions that, in response to being executed on the computing device, cause the computing device to determine a pathloss to an evolved node B (eNB) corresponding to the cell identifier.

20 In Example 68, the at least one non-transitory computer-readable storage medium of any of Examples 66 to 67 may optionally comprise wireless communication instructions that, in response to being executed on the computing device, cause the computing device to send the UL message in a dual-connectivity operation mode based on the configuration information comprised in at least one of the configuration IEs.

25 In Example 69, the at least one non-transitory computer-readable storage medium of any of Examples 66 to 67 may optionally comprise wireless communication instructions that, in response to being executed on the computing device, cause the computing device to send the UL message in a UL coordinated multipoint (UL-CoMP) operation mode based on the configuration information comprised in at least one of the configuration IEs.

30 In Example 70, the one or more configuration IEs of any of Examples 66 to 69 may optionally include at least one configuration IE comprising configuration information for communications on the part of the UE over a wireless channel of a cell corresponding to the cell identifier.

In Example 71, the wireless channel of Example 70 may optionally comprise a physical uplink control channel (PUCCH), a physical uplink shared channel (PUSCH), or a random access channel (RACH).

In Example 72, the one or more configuration IEs of any of Examples 66 to 71 may optionally include at least one configuration IE comprising configuration information for a sounding reference signal (SRS) of the UE.

5 In Example 73, the at least one non-transitory computer-readable storage medium of any of Examples 66 to 72 may optionally comprise wireless communication instructions that, in response to being executed on the computing device, cause the computing device to apply one or more priority rules to resolve a collision between multiple UL communication processes that have been configured for the UE.

10 Example 74 is a wireless communication method, comprising configuring, by a processor circuit at an evolved node B (eNB), an uplink (UL) communication process for at least one user equipment (UE), generating a UL communication process information element (IE) that describes the UL communication process, the UL communication process IE comprising a cell index for a cell served by the eNB and at least one configuration parameter comprising configuration information for a UL channel of the cell, and transmitting the UL communication  
15 process IE over a wireless channel.

In Example 75, the wireless communication method of Example 74 may optionally comprise receiving control information over a non-ideal backhaul, and configuring the UL communication process based on the control information.

20 In Example 76, the wireless communication method of Example 75 may optionally comprise receiving channel state information (CSI) for the at least one UE over the non-ideal backhaul.

In Example 77, the wireless communication method of Example 76 may optionally comprise selecting one or more resources for which to perform long-term interference avoidance based on the CSI, and sending a beamforming nulling assignment that identifies the one or more  
25 selected resources.

In Example 78, the UL channel of any of Examples 74 to 77 may optionally comprise a physical uplink control channel (PUCCH), a physical uplink shared channel (PUSCH), or a random access channel (RACH).

30 In Example 79, the UL communication process IE of any of Examples 74 to 78 may optionally include a configuration parameter comprising configuration information for a sounding reference signal (SRS).

In Example 80, the wireless communication method of any of Examples 74 to 79 may optionally comprise implementing one or more collision avoidance techniques in conjunction with configuring the UL communication process.

In Example 81, the at least one configuration parameter of any of Examples 74 to 80 may optionally comprise configuration information that applies to a plurality of cells.

Example 82 is at least one non-transitory computer-readable storage medium comprising a set of instructions that, in response to being executed on a computing device, cause the  
5 computing device to perform a wireless communication method according to any of Examples 74 to 81.

Example 83 is an apparatus, comprising means for performing a wireless communication method according to any of Examples 74 to 81.

Example 84 is a system, comprising an apparatus according to Example 83, a radio  
10 frequency (RF) transceiver, and one or more RF antennas.

Numerous specific details have been set forth herein to provide a thorough understanding of the embodiments. It will be understood by those skilled in the art, however, that the embodiments may be practiced without these specific details. In other instances, well-known operations, components, and circuits have not been described in detail so as not to obscure the  
15 embodiments. It can be appreciated that the specific structural and functional details disclosed herein may be representative and do not necessarily limit the scope of the embodiments.

Some embodiments may be described using the expression "coupled" and "connected" along with their derivatives. These terms are not intended as synonyms for each other. For example, some embodiments may be described using the terms "connected" and/or "coupled" to  
20 indicate that two or more elements are in direct physical or electrical contact with each other. The term "coupled," however, may also mean that two or more elements are not in direct contact with each other, but yet still co-operate or interact with each other.

Unless specifically stated otherwise, it may be appreciated that terms such as "processing," "computing," "calculating," "determining," or the like, refer to the action and/or processes of a  
25 computer or computing system, or similar electronic computing device, that manipulates and/or transforms data represented as physical quantities (e.g., electronic) within the computing system's registers and/or memories into other data similarly represented as physical quantities within the computing system's memories, registers or other such information storage, transmission or display devices. The embodiments are not limited in this context.

It should be noted that the methods described herein do not have to be executed in the  
30 order described, or in any particular order. Moreover, various activities described with respect to the methods identified herein can be executed in serial or parallel fashion.

Although specific embodiments have been illustrated and described herein, it should be appreciated that any arrangement calculated to achieve the same purpose may be substituted for

the specific embodiments shown. This disclosure is intended to cover any and all adaptations or variations of various embodiments. It is to be understood that the above description has been made in an illustrative fashion, and not a restrictive one. Combinations of the above embodiments, and other embodiments not specifically described herein will be apparent to those  
5 of skill in the art upon reviewing the above description. Thus, the scope of various embodiments includes any other applications in which the above compositions, structures, and methods are used.

It is emphasized that the Abstract of the Disclosure is provided to comply with 37 C.F.R. § 1.72(b), requiring an abstract that will allow the reader to quickly ascertain the nature of the  
10 technical disclosure. It is submitted with the understanding that it will not be used to interpret or limit the scope or meaning of the claims. In addition, in the foregoing Detailed Description, it can be seen that various features are grouped together in a single embodiment for the purpose of streamlining the disclosure. This method of disclosure is not to be interpreted as reflecting an intention that the claimed embodiments require more features than are expressly recited in each  
15 claim. Rather, as the following claims reflect, inventive subject matter lies in less than all features of a single disclosed embodiment. Thus the following claims are hereby incorporated into the Detailed Description, with each claim standing on its own as a separate preferred embodiment. In the appended claims, the terms "including" and "in which" are used as the plain-English equivalents of the respective terms "comprising" and "wherein," respectively.  
20 Moreover, the terms "first," "second," and "third," etc. are used merely as labels, and are not intended to impose numerical requirements on their objects.

Although the subject matter has been described in language specific to structural features and/or methodological acts, it is to be understood that the subject matter defined in the appended claims is not necessarily limited to the specific features or acts described above. Rather, the  
25 specific features and acts described above are disclosed as example forms of implementing the claims.

## CLAIMS

**What is claimed is:**

- 5 1. User equipment (UE), comprising:  
logic, at least a portion of which is in hardware, the logic to receive an uplink (UL)  
communication process configuration message identifying a configured UL communication  
process for the UE, the UL communication process configuration message comprising a cell  
10 identifier and one or more configuration information elements (IEs), each configuration IE  
comprising configuration information for UL communications on the part of the UE, the logic to  
send a UL message based on the configuration information comprised in at least one of the  
configuration IEs.
- 15 2. The UE of claim 1, the logic to determine a pathloss to an evolved node B (eNB)  
corresponding to the cell identifier.
3. The UE of claim 1, the logic to send the UL message in a dual-connectivity operation mode  
based on the configuration information comprised in at least one of the configuration IEs.
- 20 4. The UE of claim 1, the logic to send the UL message in a UL coordinated multipoint (UL-  
CoMP) operation mode based on the configuration information comprised in at least one of the  
configuration IEs.
- 25 5. The UE of claim 1, the one or more configuration IEs including at least one configuration IE  
comprising configuration information for communications on the part of the UE over a wireless  
channel of a cell corresponding to the cell identifier.
- 30 6. The UE of claim 5, the wireless channel comprising a physical uplink control channel  
(PUCCH), a physical uplink shared channel (PUSCH), or a random access channel (RACH).
7. The UE of claim 1, the one or more configuration IEs including at least one configuration IE  
comprising configuration information for a sounding reference signal (SRS) of the UE.

8. The UE of claim 1, the logic to apply one or more priority rules to resolve a collision between multiple UL communication processes that have been configured for the UE.
9. The UE of claim 1, comprising:
- 5           a radio frequency (RF) transceiver;  
          one or more RF antennas; and  
          a display.
10. At least one non-transitory computer-readable storage medium comprising a set of
- 10 instructions that, in response to being executed at user equipment (UE), cause the UE to:  
          receive an uplink (UL) communication process configuration information element (IE)  
          describing a configured UL communication process for the UE, the UL communication process  
          configuration IE comprising a cell index and one or more configuration parameters, each  
          configuration IE comprising configuration information for UL communications on the part of the
- 15 UE;  
          determine a pathloss to an evolved node B (eNB) based on the cell index; and  
          transmit a wireless signal based on at least one of the one or more configuration  
          parameters.
- 20 11. The at least one non-transitory computer-readable storage medium of claim 10, the eNB  
comprising a master eNB (MeNB) of a master cell group (MCG).
12. The at least one non-transitory computer-readable storage medium of claim 10, the eNB  
comprising a secondary eNB (SeNB) of a secondary cell group (SCG).
- 25 13. The at least one non-transitory computer-readable storage medium of claim 10, comprising  
instructions that, in response to being executed at the UE, cause the UE to transmit the wireless  
signal while operating in a dual-connectivity mode.
- 30 14. The at least one non-transitory computer-readable storage medium of claim 10, comprising  
instructions that, in response to being executed at the UE, cause the UE to transmit the wireless  
signal while operating in a UL coordinated multipoint (UL-CoMP) mode.

15. The at least one non-transitory computer-readable storage medium of claim 10, the wireless signal comprising a periodic sounding reference signal (SRS) or an aperiodic SRS.

16. The at least one non-transitory computer-readable storage medium of claim 10, the one or  
5 more configuration parameters including at least one UE-specific configuration parameter.

17. The at least one non-transitory computer-readable storage medium of claim 10, the one or  
more configuration parameters including at least one configuration parameter comprising  
configuration information for a plurality of UEs.

10

18. An evolved node B (eNB), comprising:

logic, at least a portion of which is in hardware, the logic to configure an uplink (UL)  
communication process for at least one user equipment (UE) and generate a UL communication  
process information element (IE) that describes the UL communication process, the UL  
15 communication process IE comprising a cell index for a cell served by the eNB and at least one  
configuration parameter comprising configuration information for a UL channel of the cell; and  
a radio frequency (RF) transceiver to transmit the UL communication process IE over a  
wireless channel.

20 19. The eNB of claim 18, the logic to receive control information over a non-ideal backhaul and  
configure the UL communication process based on the control information.

20. The eNB of claim 19, the logic to receive channel state information (CSI) for the at least one  
UE over the non-ideal backhaul.

25

21. The eNB of claim 20, the logic to select one or more resources for which to perform long-  
term interference avoidance based on the CSI and send a beamforming nulling assignment that  
identifies the one or more selected resources.

30 22. The eNB of claim 18, the UL channel comprising a physical uplink control channel  
(PUCCH), a physical uplink shared channel (PUSCH), or a random access channel (RACH).

23. The eNB of claim 18, the UL communication process IE including a configuration  
parameter comprising configuration information for a sounding reference signal (SRS).

24. The eNB of claim 18, the logic to implement one or more collision avoidance techniques in conjunction with configuring the UL communication process.

5 25. The eNB of claim 18, the at least one configuration parameter comprising configuration information that applies to a plurality of cells.

FIG. 1

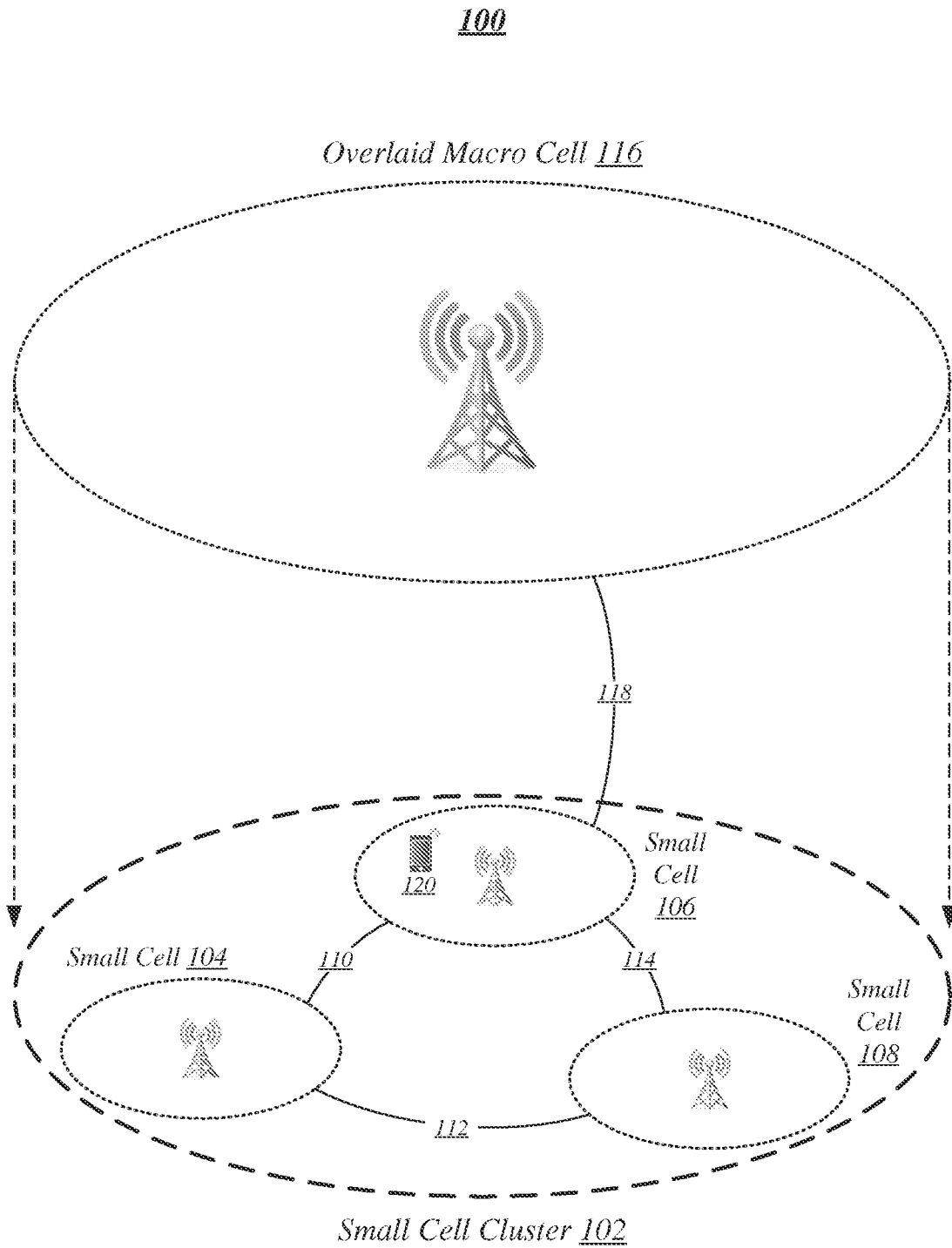

FIG. 2

200

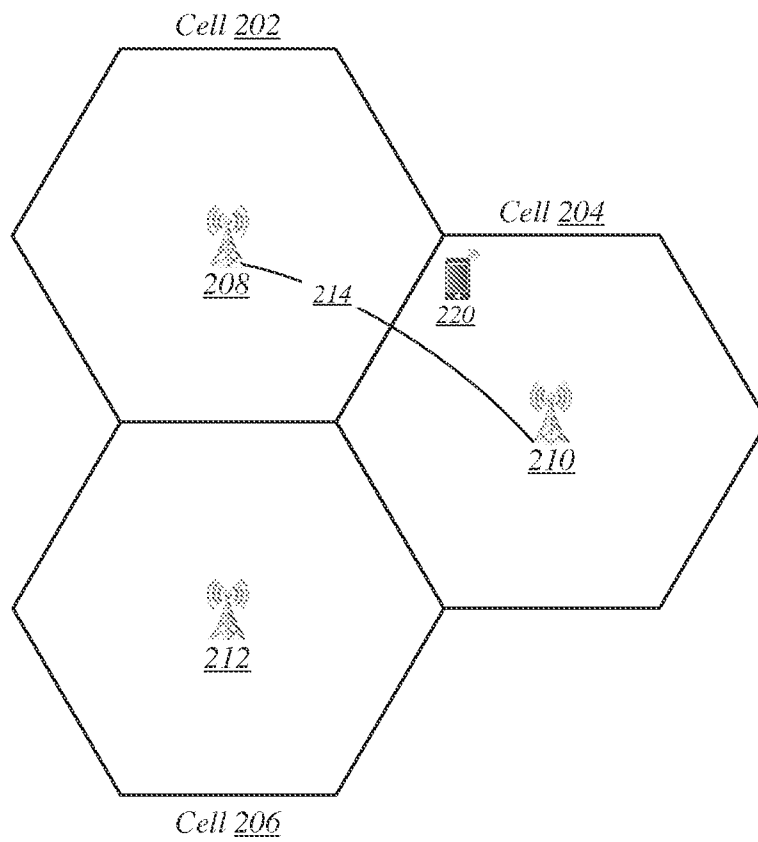

FIG. 3

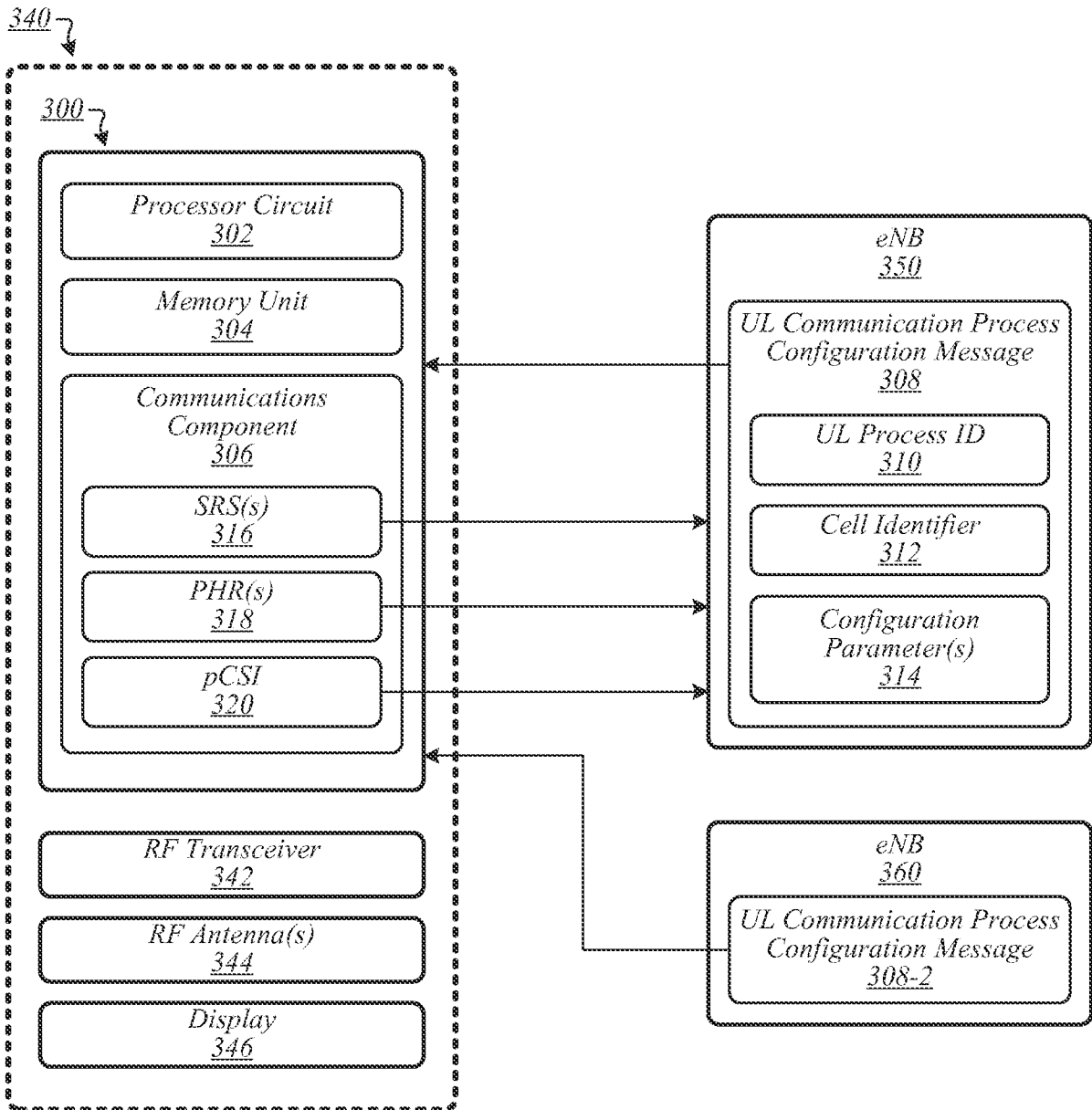
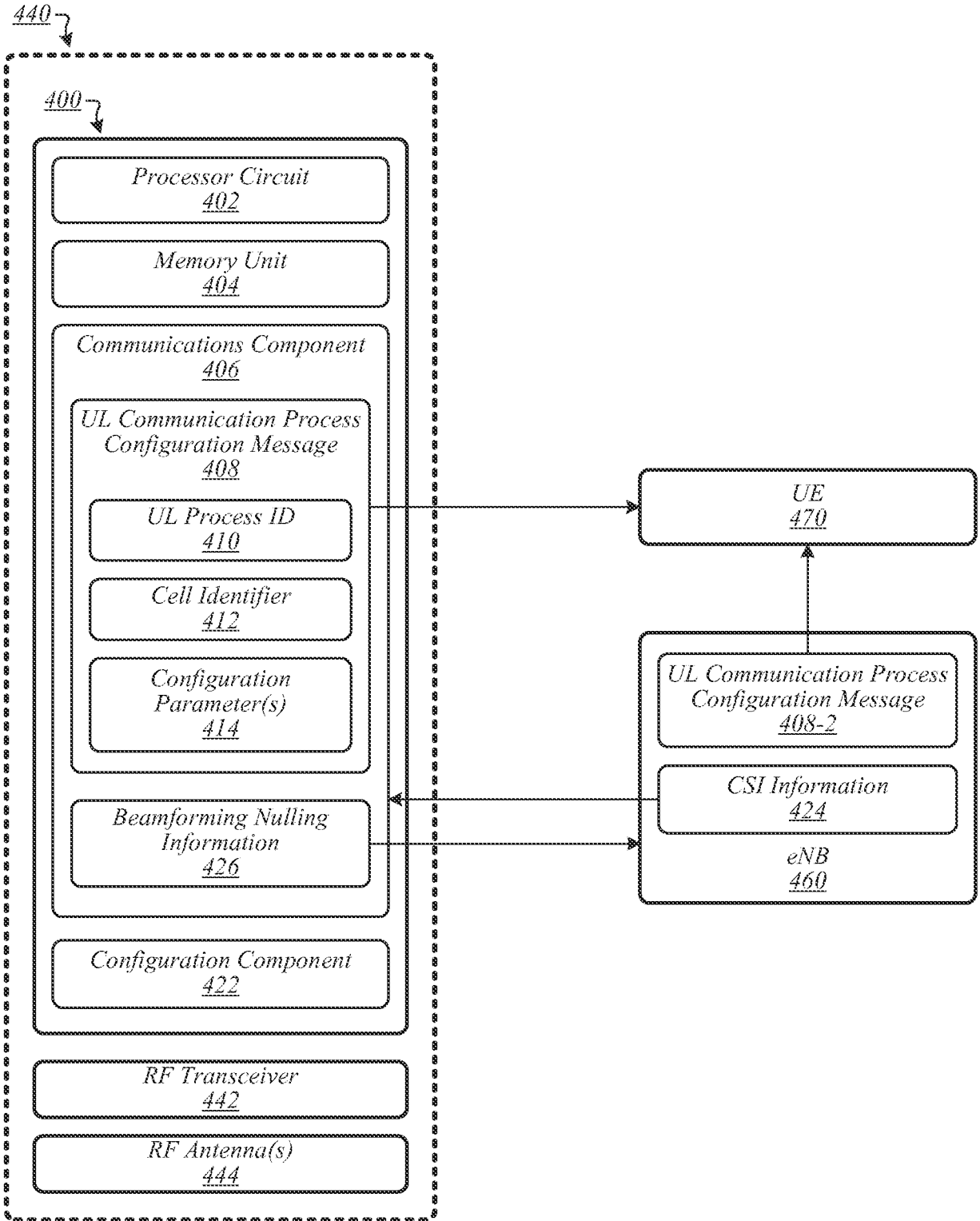
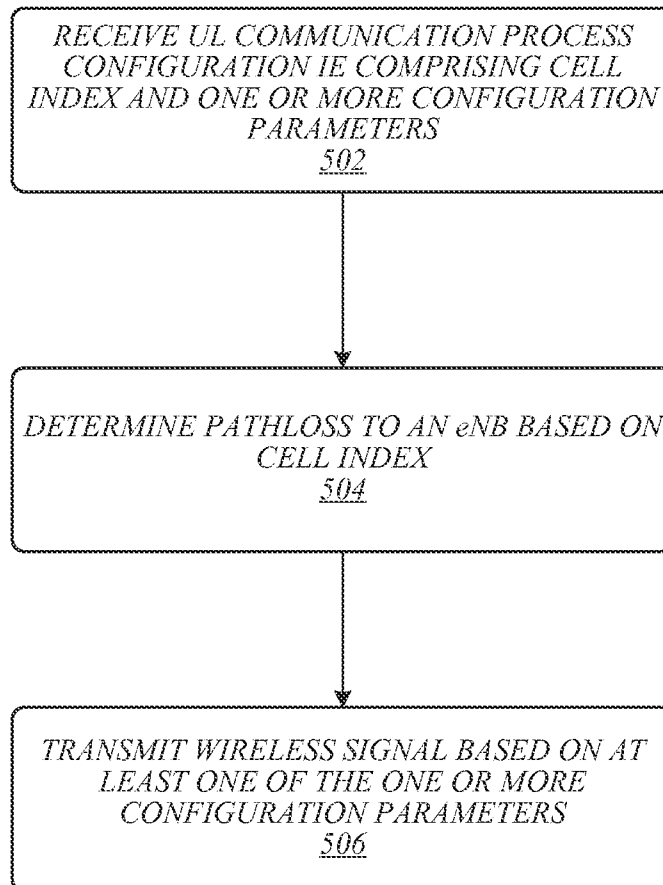

FIG. 4



5/10

FIG. 5

500

6/10

*FIG. 6*

600

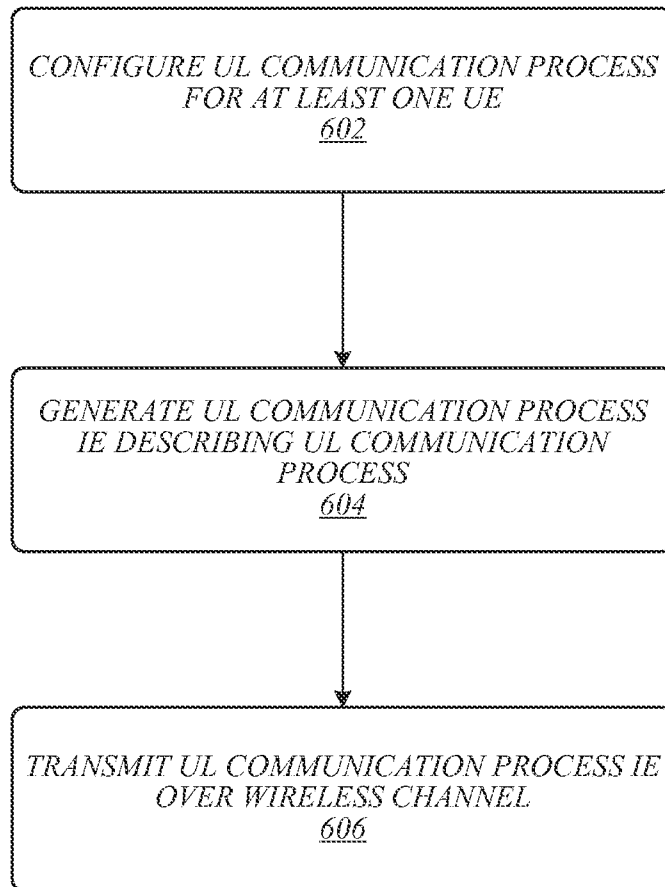

7/10

FIG. 7

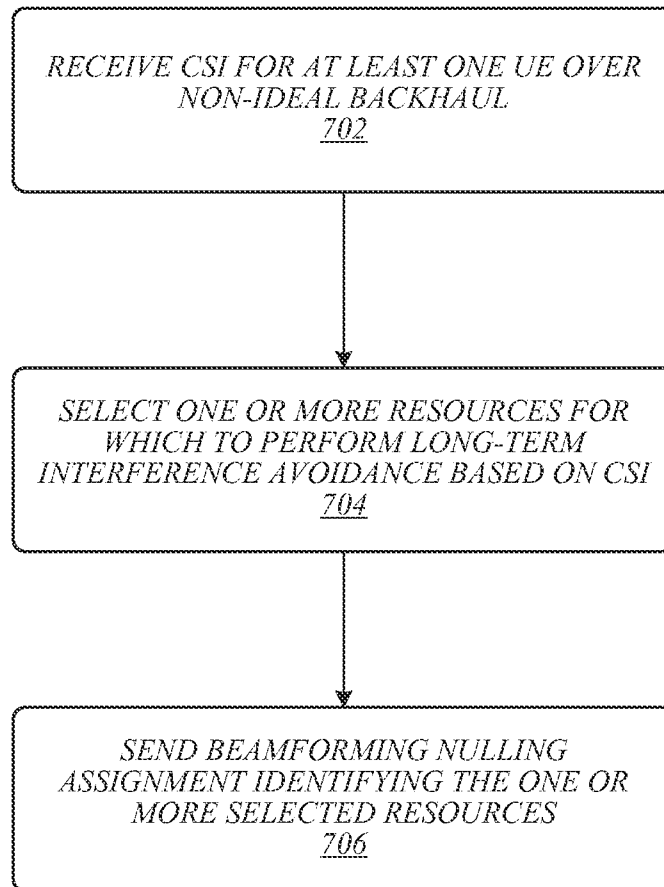
700

*FIG. 8*

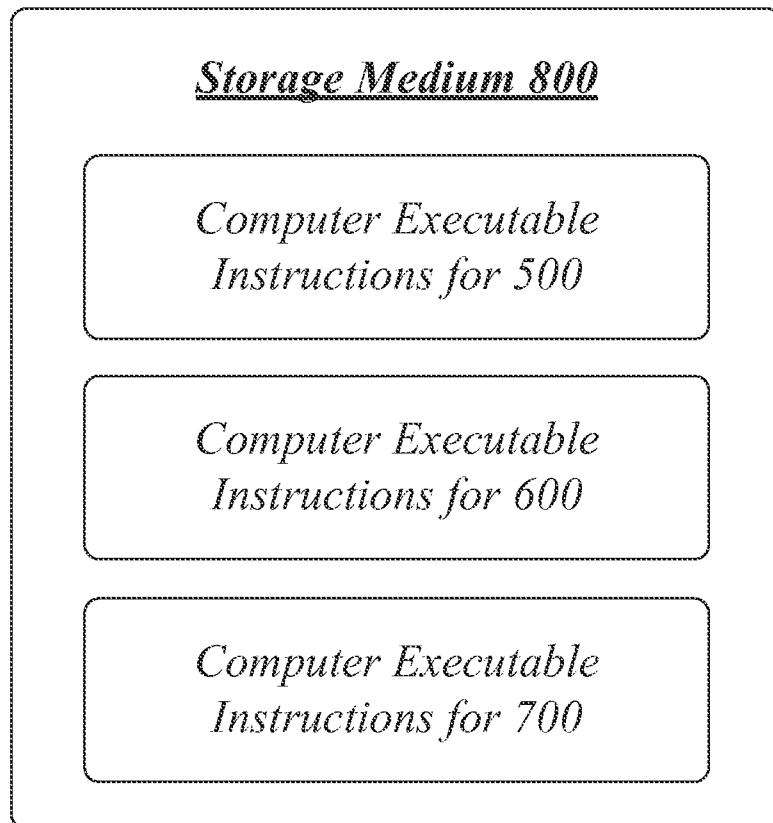
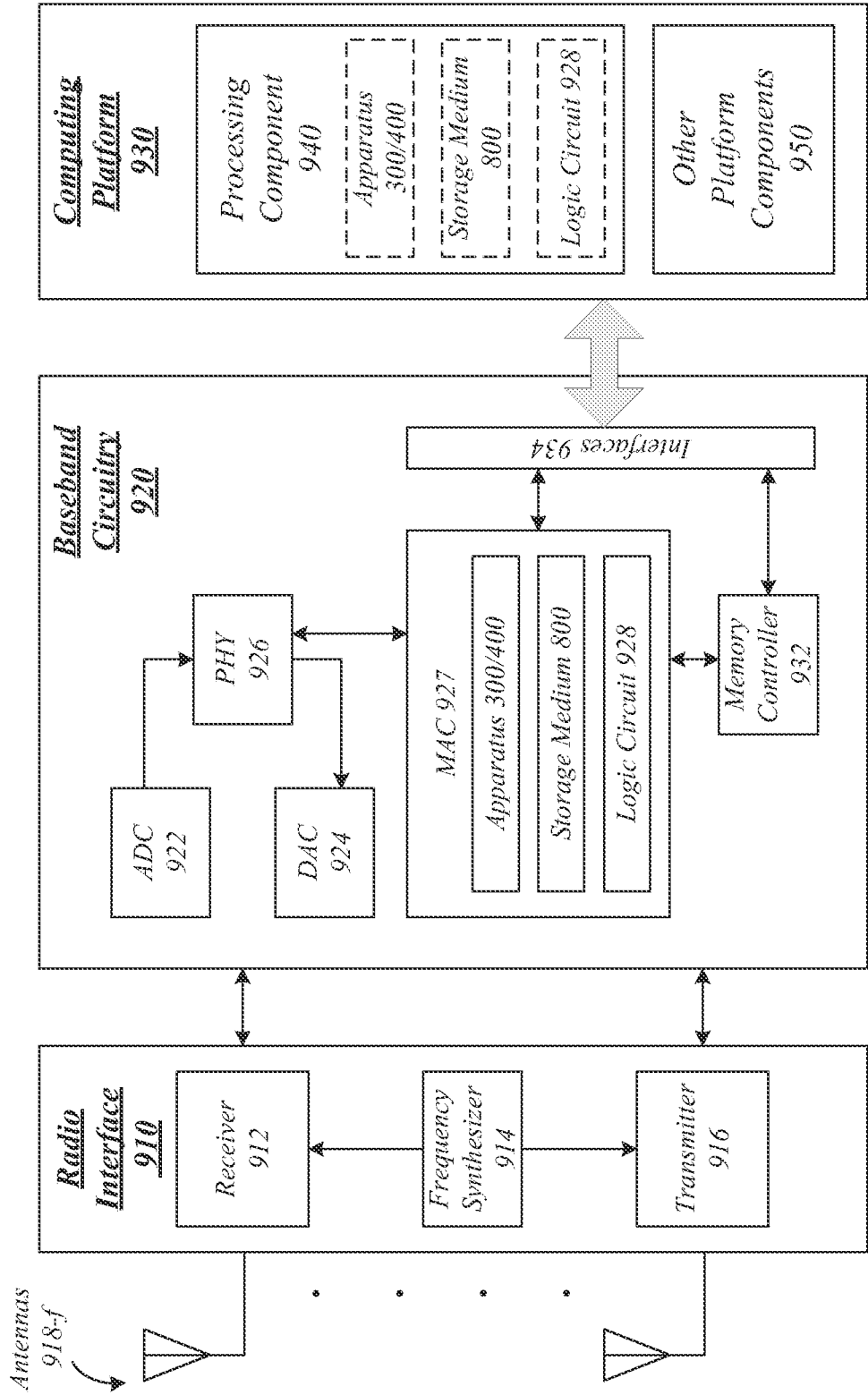

FIG. 9

Device 900



*FIG. 10*  
*Broadband Wireless Access System*

1000

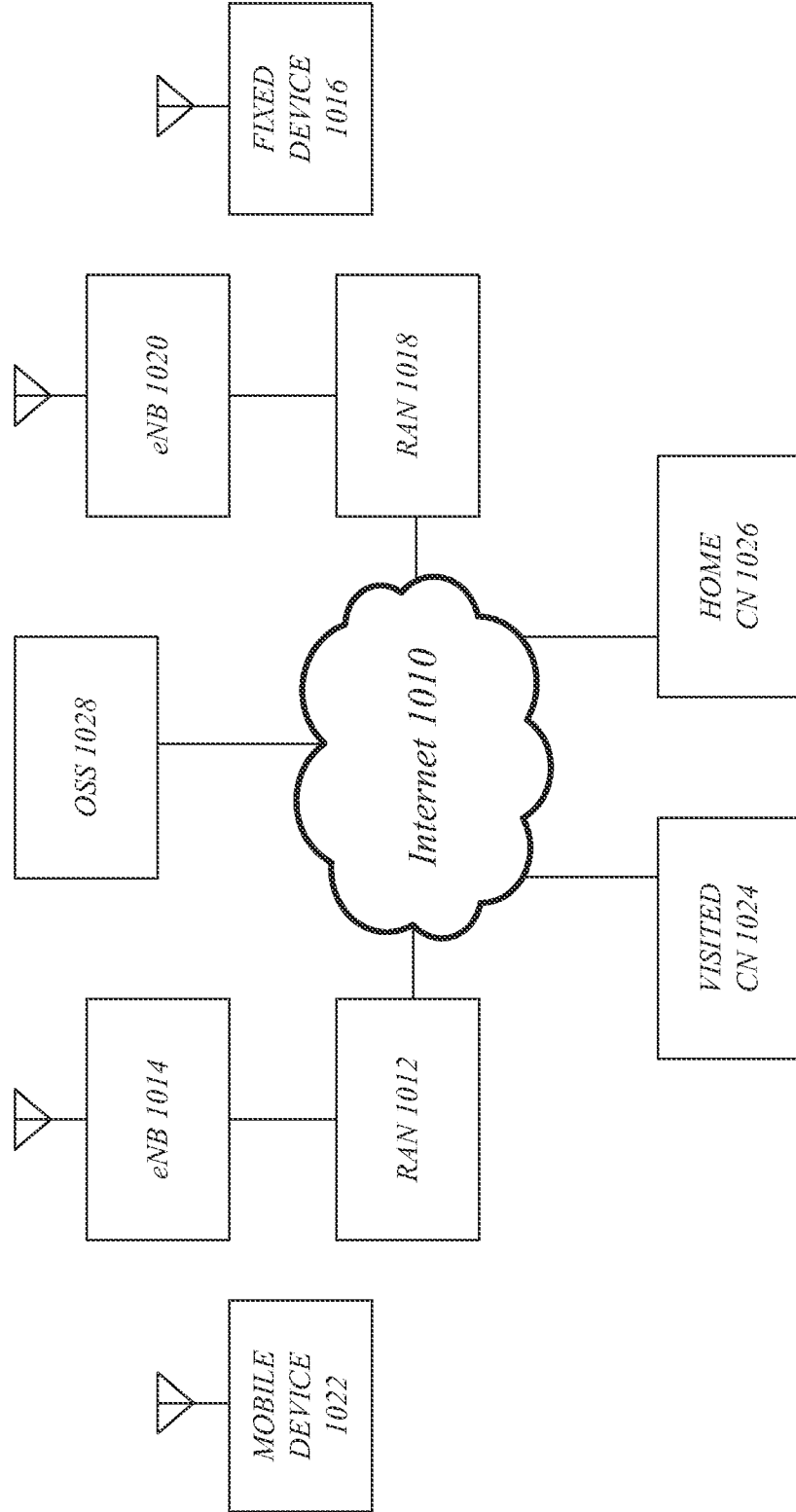

**A. CLASSIFICATION OF SUBJECT MATTER****H04B 7/26(2006.01)i, H04J 11/00(2006.01)i**

According to International Patent Classification (IPC) or to both national classification and IPC

**B. FIELDS SEARCHED**Minimum documentation searched (classification system followed by classification symbols)  
H04B 7/26; H04W 72/12; H04W 88/08; H04W 52/04; H04J 11/00Documentation searched other than minimum documentation to the extent that such documents are included in the fields searched  
Korean utility models and applications for utility models  
Japanese utility models and applications for utility modelsElectronic data base consulted during the international search (name of data base and, where practicable, search terms used)  
eKOMPASS(KIPO internal) & Keywords: UL communication process configuration message, cell identifier, configuration information elements, dual-connectivity, non-ideal backhaul**C. DOCUMENTS CONSIDERED TO BE RELEVANT**

Category*	Citation of document, with indication, where appropriate, of the relevant passages	Relevant to claim No.
X	US 2013-0077569 A1 (YOUNG-HAN NAM et al.) 28 March 2013 See paragraphs 5-6, 13, 21, 30-31, 77, 98, 104, 118, 127, 142-143; claims 1, 8-9, 15; and figures 2, 11.	1-2,4-7,9-12,14-18 ,22-23,25
Y		3,13,19-20
A		8,21,24
Y	HUAWEI et al., 'Potential technologies for small cell enhancement - physical layer support of higher-layer aspects', 3GPP TSG RAN WG1 Meeting#72, R1-130025, St. Julian's, Malta, 28 January - 1 February 2013 ( <a href="http://www.3gpp.org/ftp/tsg_ran/wg1_r11/TSGR1_72/Docs/">http://www.3gpp.org/ftp/tsg_ran/wg1_r11/TSGR1_72/Docs/</a> ) See page 1, lines 14-16; and figure 1.	3,13,19-20
A	ETRI, 'CA extension in support of inter-site CA', 3GPP TSG RAN WG1 Meeting #73, R1-132558, Fukuoka, Japan, 20-24 May 2013 ( <a href="http://www.3gpp.org/ftp/tsg_ran/wg1_r11/TSGR1_73/Docs/">http://www.3gpp.org/ftp/tsg_ran/wg1_r11/TSGR1_73/Docs/</a> ) See page 2, line 1 - page 3, line 14.	1-25
A	US 2013-0083730 A1 (PETER GAAL et al.) 04 April 2013 See paragraphs 12-14, 65-67, 80-82; and figures 7, 14-15.	1-25
A	KR 10-2013-0072207 A (SAMSUNG ELECTRONICS CO., LTD.) 01 July 2013 See paragraphs 48-56, 262-266; and figures 5b, 8.	1-25

 Further documents are listed in the continuation of Box C. See patent family annex.

\* Special categories of cited documents:

"A" document defining the general state of the art which is not considered to be of particular relevance

"E" earlier application or patent but published on or after the international filing date

"L" document which may throw doubts on priority claim(s) or which is cited to establish the publication date of another citation or other special reason (as specified)

"O" document referring to an oral disclosure, use, exhibition or other means

"P" document published prior to the international filing date but later than the priority date claimed

"T" later document published after the international filing date or priority date and not in conflict with the application but cited to understand the principle or theory underlying the invention

"X" document of particular relevance; the claimed invention cannot be considered novel or cannot be considered to involve an inventive step when the document is taken alone

"Y" document of particular relevance; the claimed invention cannot be considered to involve an inventive step when the document is combined with one or more other such documents, such combination being obvious to a person skilled in the art

"&amp;" document member of the same patent family

Date of the actual completion of the international search

07 November 2014 (07.11.2014)

Date of mailing of the international search report

**07 November 2014 (07.11.2014)**

Name and mailing address of the ISA/KR

International Application Division  
Korean Intellectual Property Office  
189 Cheongsu-ro, Seo-gu, Daejeon Metropolitan City, 302-701,  
Republic of Korea

Facsimile No. +82-42-472-7140

Authorized officer

KANG, Hee Gok

Telephone No. +82-42-481-8264



**INTERNATIONAL SEARCH REPORT**

Information on patent family members

International application No.

**PCT/US2014/048106**

Patent document cited in search report	Publication date	Patent family member(s)	Publication date
US 2013-0077569 A1	28/03/2013	CN 103828274 A EP 2767016 A1 US 8743791 B2 WO 2013-043010 A1	28/05/2014 20/08/2014 03/06/2014 28/03/2013
US 2013-0083730 A1	04/04/2013	EP 2764736 A1 EP 2764737 A1 EP 2764738 A1 KR 10-2014-0084115 A US 2013-0083731 A1 US 2013-0084913 A1 WO 2013-052119 A1 WO 2013-052134 A1 WO 2013-052135 A1	13/08/2014 13/08/2014 13/08/2014 04/07/2014 04/04/2013 04/04/2013 11/04/2013 11/04/2013 11/04/2013
KR 10-2013-0072207 A	01/07/2013	CN 102884742 A EP 2385736 A1 EP 2385736 B1 EP 2613602 A2 EP 2613602 A3 JP 2013-526231 A US 2011-0274043 A1 US 8422429 B2 WO 2011-139068 A2 WO 2011-139068 A3	16/01/2013 09/11/2011 22/05/2013 10/07/2013 07/08/2013 20/06/2013 10/11/2011 16/04/2013 10/11/2011 02/02/2012