



US00D870598S

(12) **United States Design Patent**
Tran

(10) **Patent No.:** **US D870,598 S**

(45) **Date of Patent:** **** Dec. 24, 2019**

(54) **COVER FOR A JACK HANDLE ASSEMBLY**

(71) Applicant: **Dutton-Lainson Company**, Hastings, NE (US)

(72) Inventor: **Bang Brian Tran**, Hastings, NE (US)

(73) Assignee: **DUTTON-LAINSON COMPANY**, Hastings, NE (US)

(**) Term: **15 Years**

(21) Appl. No.: **29/646,522**

(22) Filed: **May 4, 2018**

(51) **LOC (12) Cl.** **12-10**

(52) **U.S. Cl.** **D12/106**
USPC

(58) **Field of Classification Search**
USPC D12/159-163, 167, 169, 172, 203, 223, D12/400-416, 100-106, 317, 19, 129, D12/111, 112, 425, 435; 224/923, 924, 224/42.11, 42.12, 401, 412, 413, 488, 224/494, 500, 501, 519, 537; 211/100, 211/124, 2, 4; 56/DIG. 14; 150/166; 135/88.05; 280/406.2, 407, 407.1, 408, 280/411.1, 416.1, 416.2, 416.3, 418, 280/418.1, 433, 434, 435, 441.1, 441.2, 280/455.1, 456.1, 480, 493, 504, 507, 280/508, 47.131; 37/399; D34/31, 35, D34/21-26, 12, 16-19; 254/97; 114/344; D8/300, 375; 414/559
CPC . B62D 35/02; B62D 35/00; B60P 3/10; B60P 3/1033; A62B 3/005

See application file for complete search history.

(56) **References Cited**

U.S. PATENT DOCUMENTS

1,486,366 A * 3/1924 Dieter E05F 11/382
74/547
2,290,815 A * 7/1942 Ruppel G05G 1/085
74/545

2,383,204 A * 8/1945 Le Veque B66F 3/02
254/97
2,638,315 A * 5/1953 Wagner B60D 1/66
254/420
3,851,855 A * 12/1974 Douglass B66F 3/08
254/420
3,863,894 A * 2/1975 Mansi B60D 1/66
254/420
3,921,958 A * 11/1975 Brockelsby B60D 1/66
254/420

(Continued)

OTHER PUBLICATIONS

DLx-P Tongue Jack—1500 lb., Dutton-Lainson.com, [online], [site visited Aug. 21, 2019], <URL: <https://www.dutton-lainson.com/proddetail.php?prod=22335>> (Year: 2019).*

(Continued)

Primary Examiner — T Chase Nelson
Assistant Examiner — Jonathan J. Han
(74) *Attorney, Agent, or Firm* — Michael S. Hargis; King & Schickli, PLLC

(57) **CLAIM**

The ornamental design for a cover for a jack handle assembly, as shown and described.

DESCRIPTION

FIG. 1 is a perspective view of my invention for a cover for a jack handle assembly;
FIG. 2 is a top view of the invention;
FIG. 3 is a bottom view of the invention;
FIG. 4 is a right side view of the invention;
FIG. 5 is a left side view of the invention;
FIG. 6 is a front view of the invention; and,
FIG. 7 is a rear view of the invention.
The broken lines in the figures depict environment and form no part of the claimed design.

1 Claim, 7 Drawing Sheets

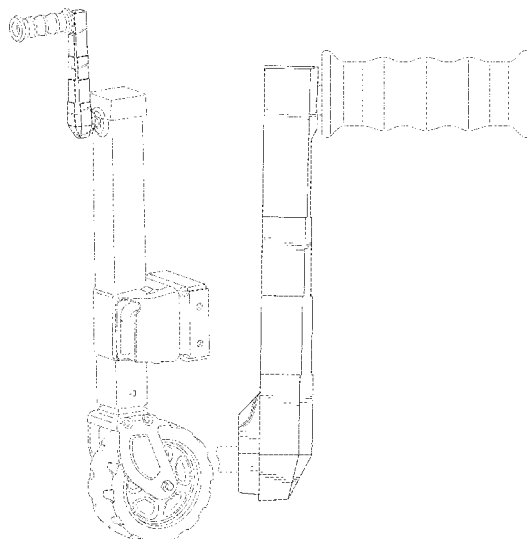

(56)

References Cited

U.S. PATENT DOCUMENTS

3,934,852 A * 1/1976 Weber B60D 1/66
254/420
3,957,249 A * 5/1976 Williams B60S 9/08
254/45
4,083,264 A * 4/1978 Van Klompenburg .. G05G 1/12
16/441
4,702,458 A * 10/1987 Kendrick B60D 1/66
254/420
D318,355 S 7/1991 Salvesen
D331,531 S * 12/1992 Guhl D8/309
D340,340 S * 10/1993 Allen 280/79.7
5,282,605 A 2/1994 Sauber
5,394,769 A * 3/1995 Cropley B66D 1/7468
74/545
D361,490 S * 8/1995 Vetter D8/309
5,509,327 A * 4/1996 Cropley B66D 1/7468
74/545
6,112,617 A * 9/2000 Abrams G05G 1/10
74/543
6,302,381 B1 10/2001 Roll
6,446,937 B1 * 9/2002 Straw, Sr. B60S 9/08
248/352
D568,575 S 5/2008 Walstrom et al.
D570,072 S 5/2008 Walstrom et al.
D577,175 S 9/2008 Walstrom et al.
D595,922 S 7/2009 Walstrom et al.
D595,923 S * 7/2009 Walstrom D34/35
7,621,356 B2 * 11/2009 Quarberg B60D 1/246
180/11
8,523,148 B2 9/2013 Beck et al.
D722,414 S * 2/2015 Lusty D34/31

D760,057 S * 6/2016 Bertani D8/309
D801,618 S * 10/2017 Weber D34/35
D811,037 S * 2/2018 Weber D34/35
9,896,067 B2 2/2018 Okerlund et al.
2004/0159826 A1 * 8/2004 Peschmann B60S 9/22
254/420
2007/0075538 A1 * 4/2007 Goettker B60S 9/18
280/766.1
2009/0057633 A1 3/2009 Beck et al.
2010/0133783 A1 * 6/2010 Walstrom B60S 9/21
280/475
2010/0263476 A1 * 10/2010 Peschmann G05G 1/085
74/546
2014/0367626 A1 * 12/2014 Okerlund B60S 9/18
254/420
2017/0259964 A1 * 9/2017 Suh B65D 41/0485
2018/0264901 A1 * 9/2018 Downs B60D 1/665

OTHER PUBLICATIONS

Trailer Swivel Jack, 1000 Lbs., Grainger.com, [online], [site visited Aug. 21, 2019]. <URL: https://www.grainger.com/product/6ZAT0?gclid=EAlalQobChMlyd7L8dU5AIVzGSGCh1cwQYNEAQYBiABEgl6a_D_BwE&cm_mmc=PPC:+Google+PLA&ef_id=EAlalQobChMlyd7L8dU5AIVzGSGCh1c> (Year: 2019).
Shift Levers, TwistedThrottle.com, [online], [site visited Aug. 21, 2019]. <URL: <https://www.twistedthrottle.com/shop-by-product/ergonomics-rider-comfort/shift-levers>> (Year: 2019).
Maxwell Replacement Emergency Windlass Crank Handle / Crank Lever, Defender.com, [online], [site visited Aug. 21, 2019]. <URL: <https://www.defender.com/product.jsp?id=1013104>> (Year: 2019).*

* cited by examiner

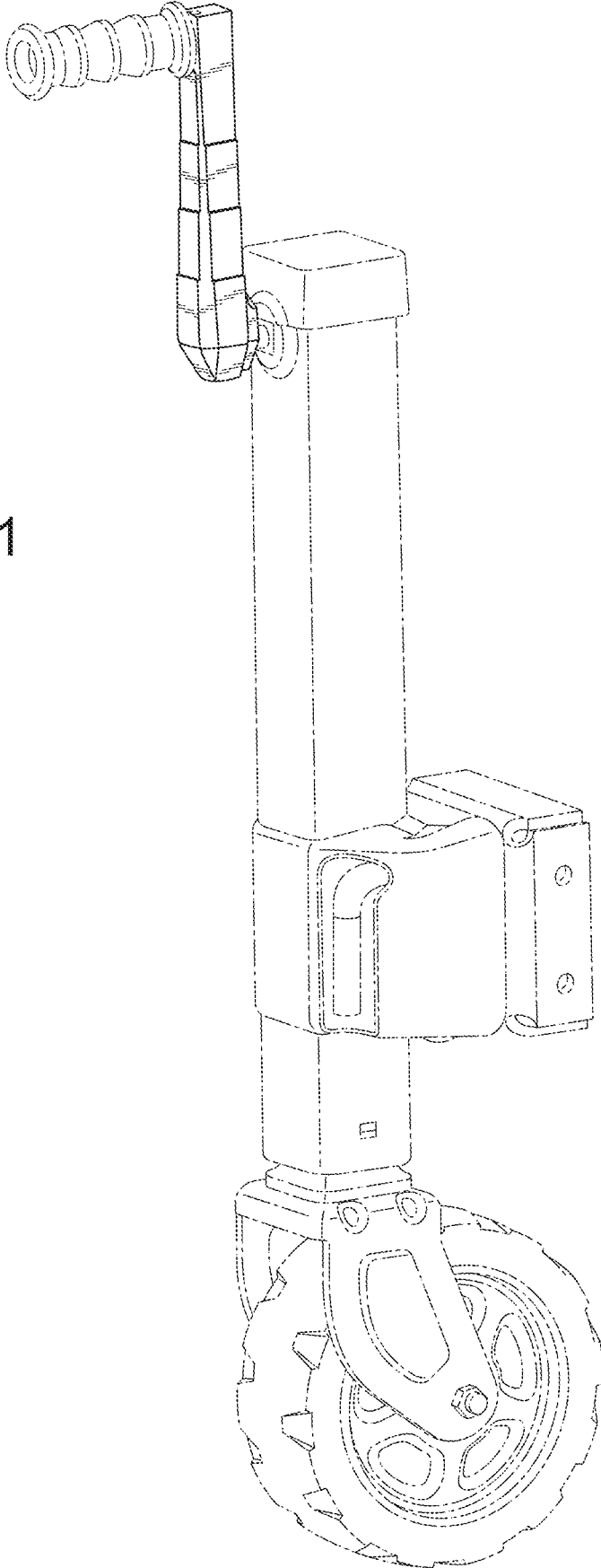

FIG. 1

FIG. 2

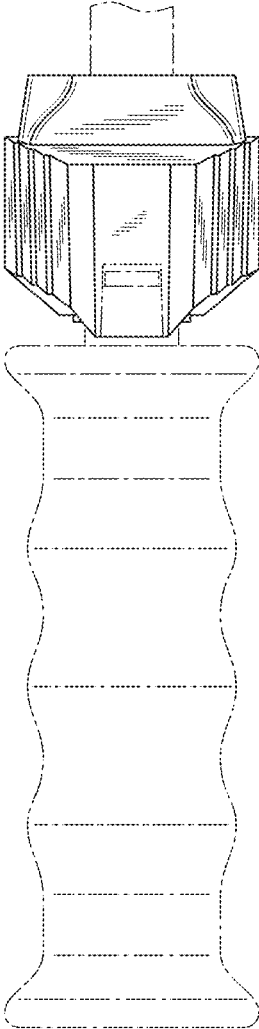

FIG. 3

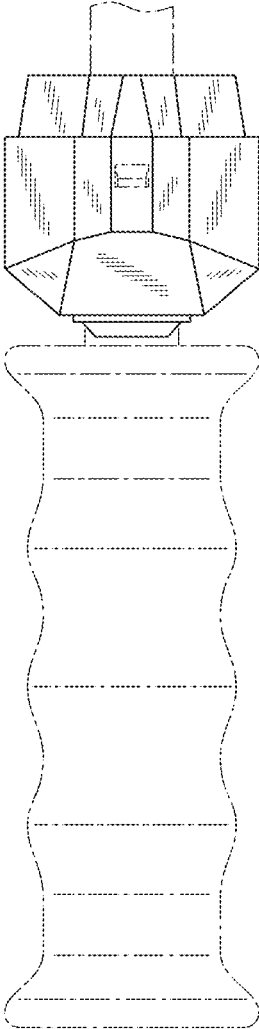

FIG. 4

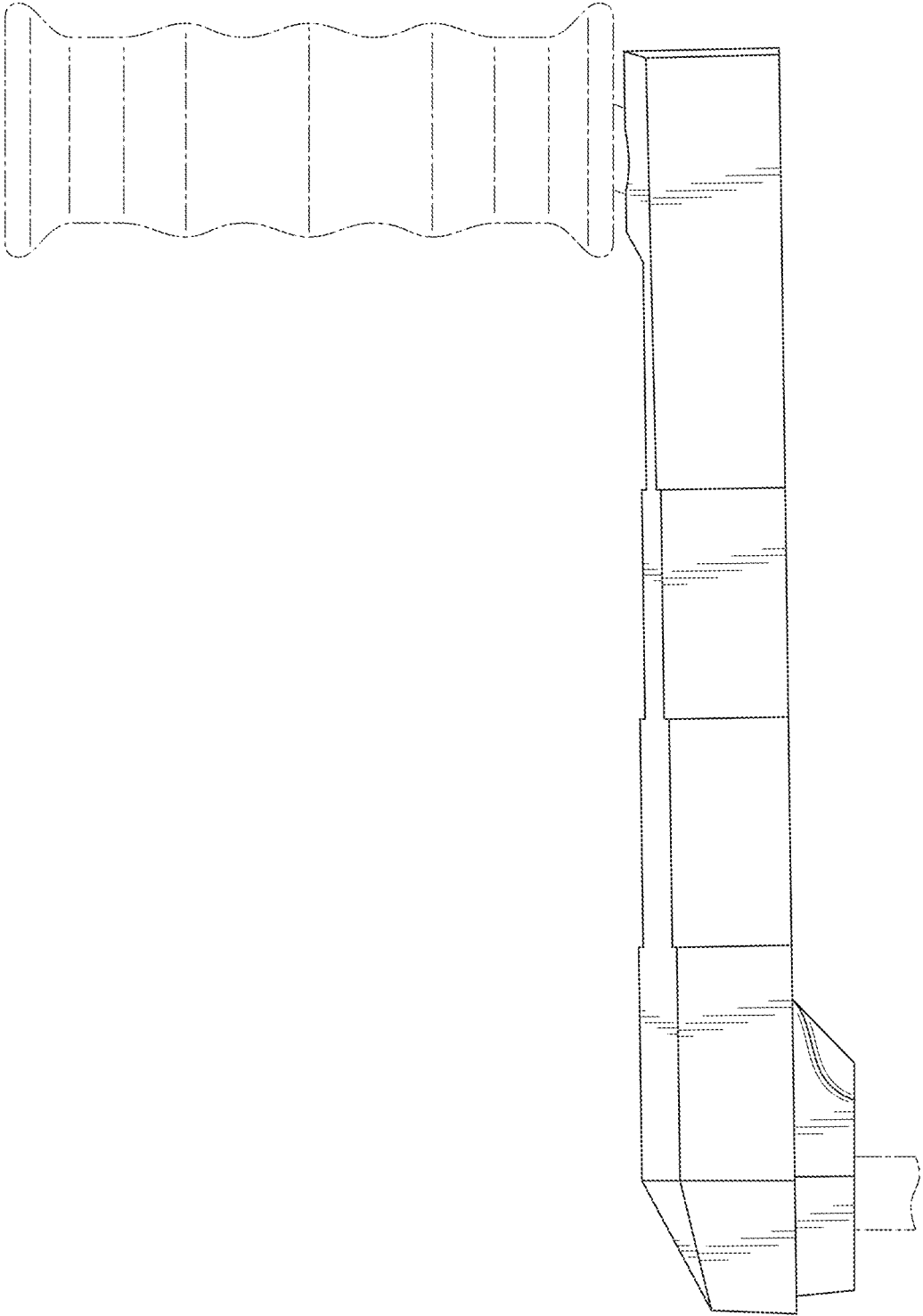

FIG. 5

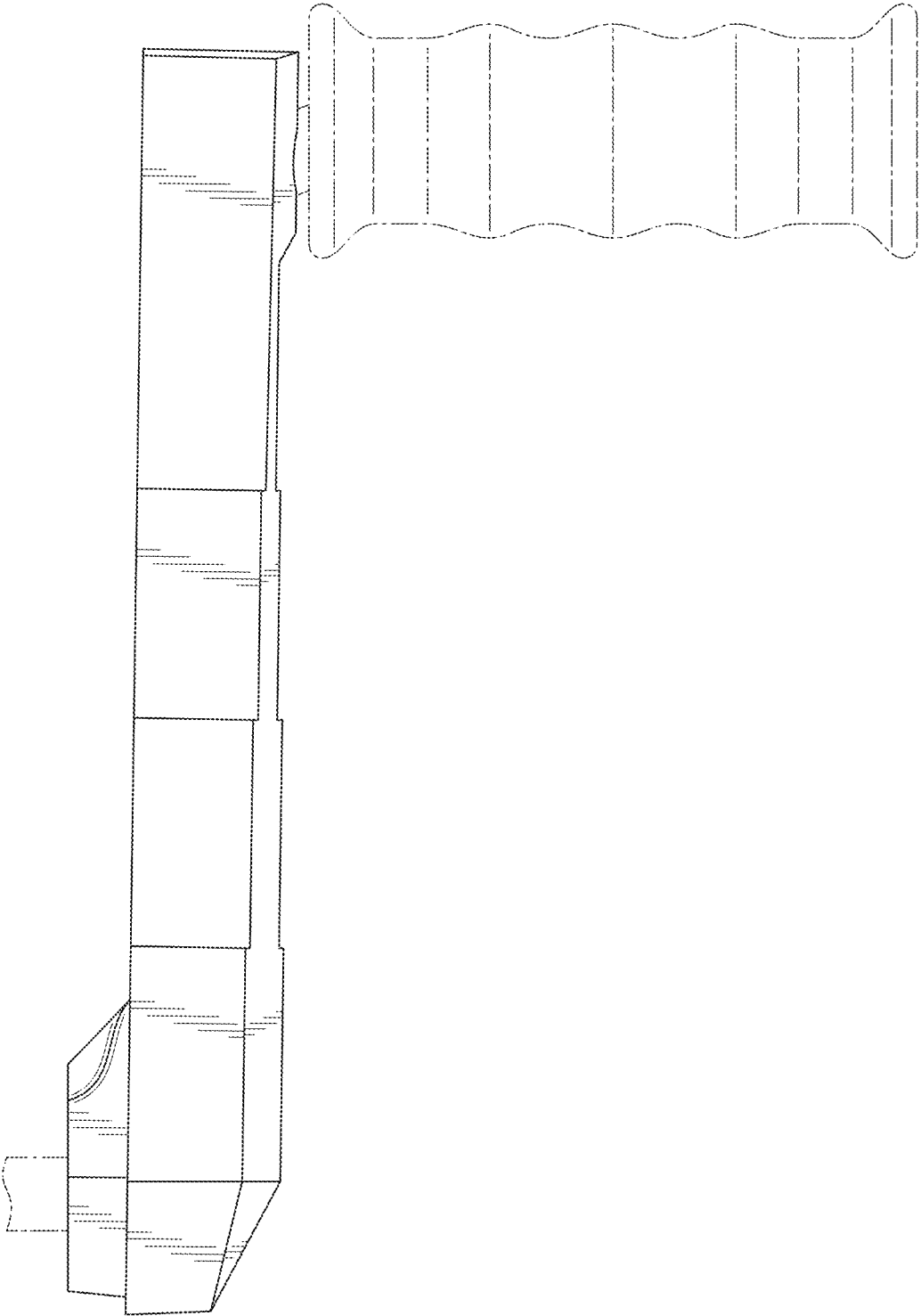

FIG. 6

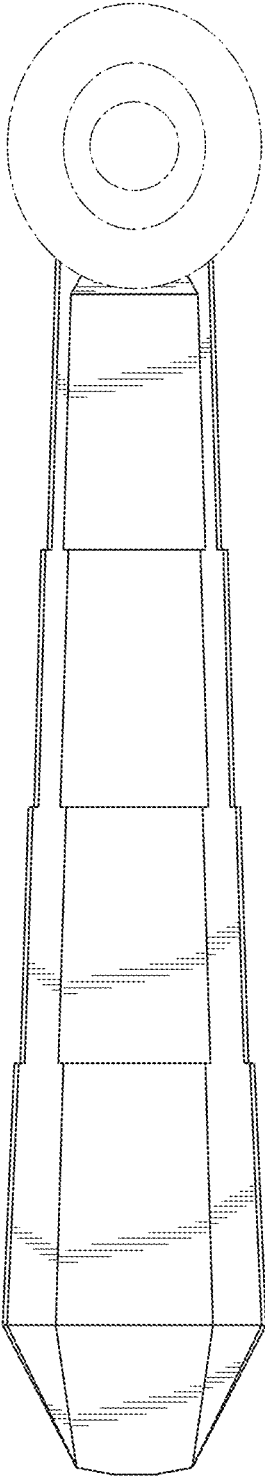

FIG. 7

