

Fig.1A

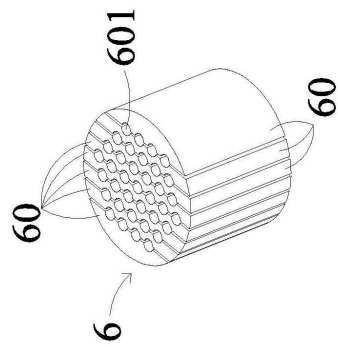

Fig.1B

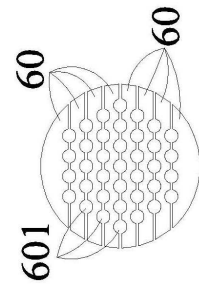

Fig.1C

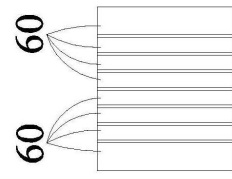

Fig.1D

Sanchita

Dr. SANCHITA GANGULI
of S. MAJUMDAR & CO.
(Applicant's Agent)

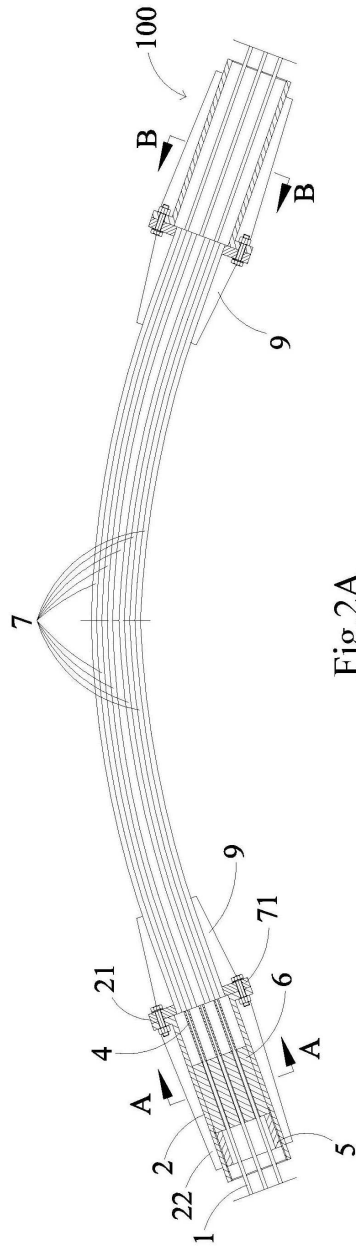

Fig.2A

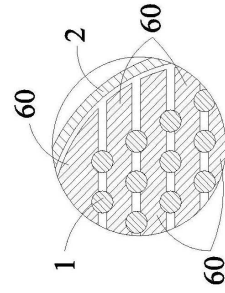

Fig.2C

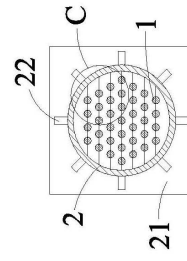

Fig.2B

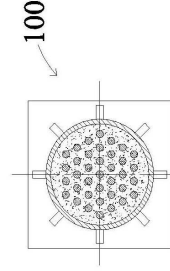

Fig.2D

Sanchita

Dr. SANCHITA GANGULI
of S. MAJUMDAR & CO.
(Applicant's Agent)

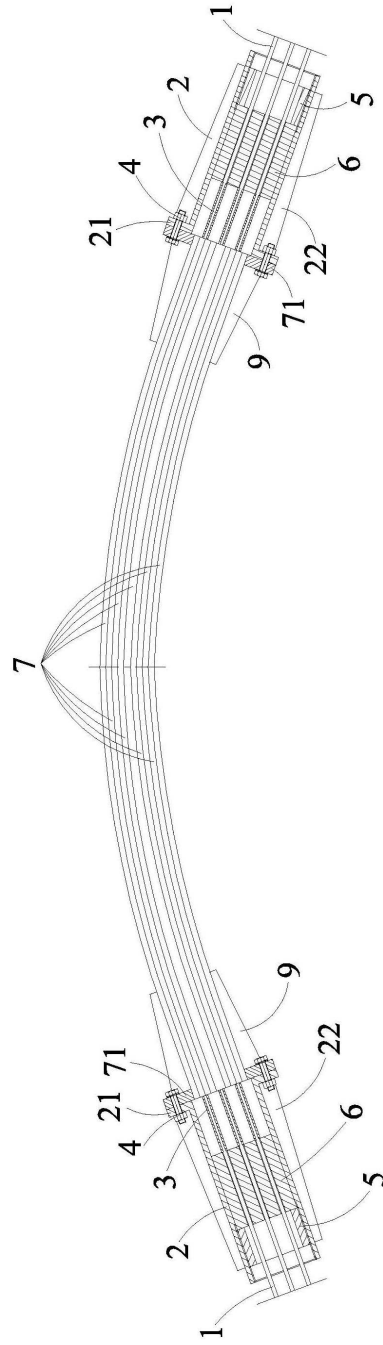

Fig.3

Sanchita

Dr. SANCHITA GANGULI
of S. MAJUMDAR & CO.
(Applicant's Agent)

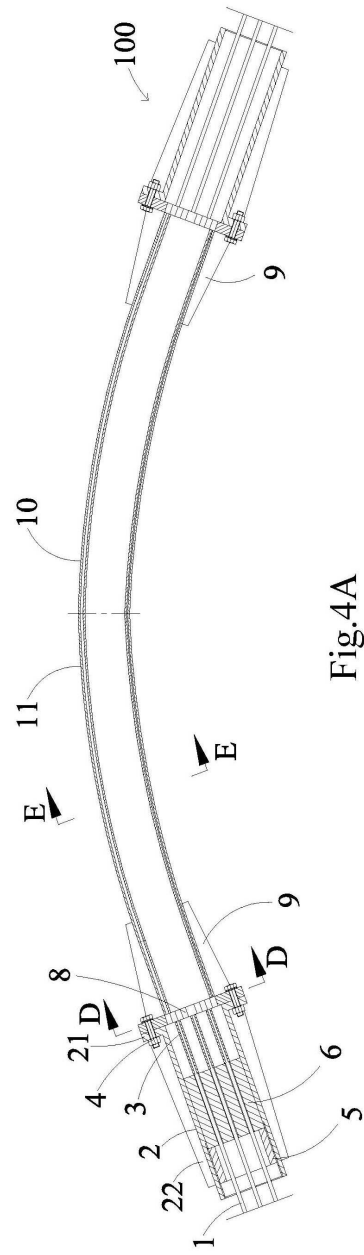

Fig.4A

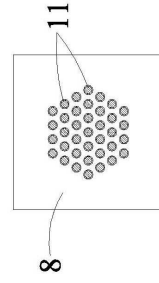

Fig.4B

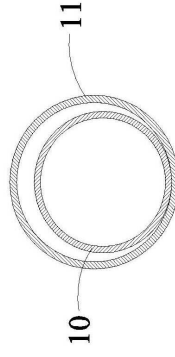

Fig.4C

Sanchita

Dr. SANCHITA GANGULI
of S. MAJUMDAR & CO.
(Applicant's Agent)

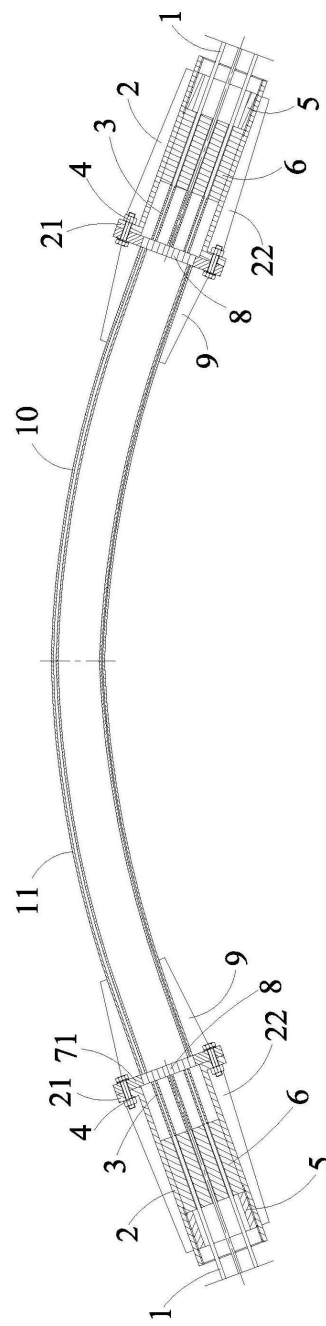

Fig.5

Sanchita

Dr. SANCHITA GANGULI
of S. MAJUMDAR & CO.
(Applicant's Agent)

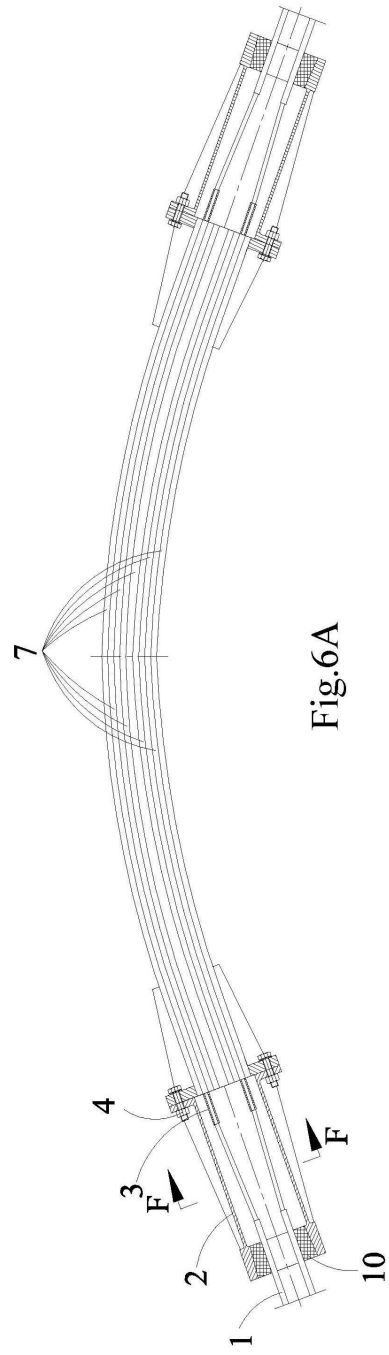

Fig.6A

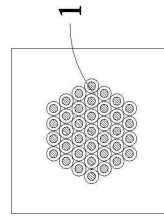

Fig.6B

Sanchita

Dr. SANCHITA GANGULI
of S. MAJUMDAR & CO.
(Applicant's Agent)