



(43) International Publication Date
19 September 2013 (19.09.2013)

- (51) International Patent Classification:
H04J 11/00 (2006.01) *H04B 7/26* (2006.01)
- (21) International Application Number:
PCT/US2013/031796
- (22) International Filing Date:
14 March 2013 (14.03.2013)
- (25) Filing Language:
English
- (26) Publication Language:
English
- (30) Priority Data:
61/612,188 16 March 2012 (16.03.2012) US
13/598,320 29 August 2012 (29.08.2012) US
13/646,223 5 October 2012 (05.10.2012) US
- (71) Applicant (for all designated States except US): **INTEL CORPORATION** [US/US]; 2200 Mission College Boulevard, Santa Clara, California 95054 (US).
- (72) Inventors; and
(71) Applicants (for US only): **CHEN, Xiaogang** [CN/CN]; Raycom Building A 8F, Ke Xue Yuan Nan Lu 2#, Haidian District, Beijing 100080 (CN). **ZHU, Yuan** [CN/CN]; Room 605, Building 16, Mo Lin Yuan Bei Yuan Jia Yuan,

Chao Yan District, Beijing 100012 (CN). **LI, Qinghua** [US/US]; 5117 Chiltern Lane, San Ramon, California 94582 (US). **HAN, Seunghee** [KR/KR]; 203-901 Hogye 2nd Hyundai Hometown, Hogye 3 Dong Dongangu, Anyangshi, Kyoungkido 431-764 (KR).

(74) Agents: **OSBORNE, David W.** et al.; Thorpe, North & Western, LLP, c/o CPA GLOBAL, P.O. Box 52050, Minneapolis, Minnesota 55402 (US).

(81) Designated States (unless otherwise indicated, for every kind of national protection available): AE, AG, AL, AM, AO, AT, AU, AZ, BA, BB, BG, BH, BN, BR, BW, BY, BZ, CA, CH, CL, CN, CO, CR, CU, CZ, DE, DK, DM, DO, DZ, EC, EE, EG, ES, FI, GB, GD, GE, GH, GM, GT, HN, HR, HU, ID, IL, IN, IS, JP, KE, KG, KM, KN, KP, KR, KZ, LA, LC, LK, LR, LS, LT, LU, LY, MA, MD, ME, MG, MK, MN, MW, MX, MY, MZ, NA, NG, NI, NO, NZ, OM, PA, PE, PG, PH, PL, PT, QA, RO, RS, RU, RW, SC, SD, SE, SG, SK, SL, SM, ST, SV, SY, TH, TJ, TM, TN, TR, TT, TZ, UA, UG, US, UZ, VC, VN, ZA, ZM, ZW.

(84) Designated States (unless otherwise indicated, for every kind of regional protection available): ARIPO (BW, GH, GM, KE, LR, LS, MW, MZ, NA, RW, SD, SL, SZ, TZ,

[Continued on next page]

(54) Title: DOWNLINK CONTROL INFORMATION (DCI) VALIDATION FOR ENHANCED PHYSICAL DOWNLINK CONTROL CHANNEL (ePDCCH)

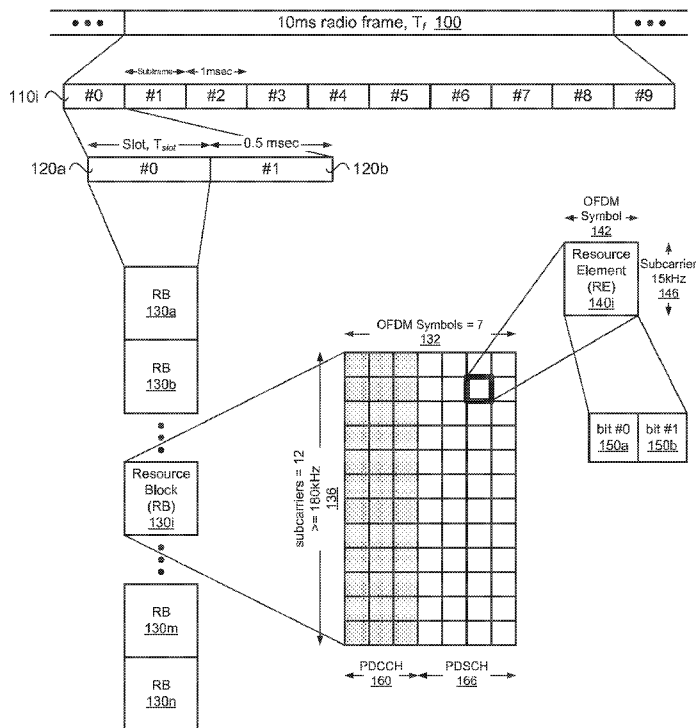

(57) Abstract: Technology for downlink (DL) grant validation is disclosed. One method can include a wireless device receiving from a node a downlink grant masked with a cell radio network temporary identifier (C-RNTI) for a resource allocation (RA) including an enhanced physical downlink control channel (ePDCCH) physical resource block (PRB) carrying the downlink grant. The wireless device can validate a downlink control information (DCI) format of the downlink grant. The at least two UERS ports can be used to transmit two CCEs. The wireless device can determine that the downlink grant is received with a non-matching cyclic redundancy check (CRC) when the DCI format is not validated.

WO 2013/138674 A1

UG, ZM, ZW), Eurasian (AM, AZ, BY, KG, KZ, RU, TJ, **Published:**
TM), European (AL, AT, BE, BG, CH, CY, CZ, DE, DK, — *with international search report (Art. 21(3))*
EE, ES, FI, FR, GB, GR, HR, HU, IE, IS, IT, LT, LU,
LV, MC, MK, MT, NL, NO, PL, PT, RO, RS, SE, SI, SK,
SM, TR), OAPI (BF, BJ, CF, CG, CI, CM, GA, GN, GQ,
GW, ML, MR, NE, SN, TD, TG).

DOWNLINK CONTROL INFORMATION (DCI) VALIDATION FOR ENHANCED PHYSICAL DOWNLINK CONTROL CHANNEL (ePDCCH)

BACKGROUND

Wireless mobile communication technology uses various standards and protocols to transmit data between a node (e.g., a transmission station or a transceiver node) and a wireless device (e.g., a mobile device). Some wireless devices communicate using orthogonal frequency-division multiple access (OFDMA) in a downlink (DL) transmission and single carrier frequency division multiple access (SC-FDMA) in an uplink (UL) transmission. Standards and protocols that use orthogonal frequency-division multiplexing (OFDM) for signal transmission include the third generation partnership project (3GPP) long term evolution (LTE), the Institute of Electrical and Electronics Engineers (IEEE) 802.16 standard (e.g., 802.16e, 802.16m), which is commonly known to industry groups as WiMAX (Worldwide interoperability for Microwave Access), and the IEEE 802.11 standard, which is commonly known to industry groups as WiFi.

In 3GPP radio access network (RAN) LTE systems, the node can be a combination of Evolved Universal Terrestrial Radio Access Network (E-UTRAN) Node Bs (also commonly denoted as evolved Node Bs, enhanced Node Bs, eNodeBs, or eNBs) and Radio Network Controllers (RNCs), which communicates with the wireless device, known as a user equipment (UE). The downlink (DL) transmission can be a communication from the node (e.g., eNodeB) to the wireless device (e.g., UE), and the uplink (UL) transmission can be a communication from the wireless device to the node.

In LTE, data can be transmitted from the eNode B to the UE via a physical downlink shared channel (PDSCH). A physical downlink control channel (PDCCH) can be used to transfer downlink control information (DCI) that informs the UE about resource allocations or scheduling related to downlink resource assignments on the PDSCH, uplink resource grants, and uplink power control commands. The PDCCH can be transmitted prior the PDSCH in each subframe transmitted from the eNode B to the UE.

The PDCCH signal can be designed to be demodulated at the UE based on a cell specific reference signal (CRS). However, the use of a CRS does not

FIG. 8 illustrates a block diagram of a resource allocation (RA) type 1 to allocate six physical resource blocks (PRBs) including at least one enhanced physical downlink control channel (ePDCCH) PRB in accordance with an example;

5 FIG. 9 illustrates a block diagram of a resource allocation (RA) type 1 to allocate four physical resource blocks (PRBs) excluding at least one enhanced physical downlink control channel (ePDCCH) PRB in accordance with an example;

10 FIG. 10 illustrates a block diagram of a resource allocation (RA) type 0 to allocate three resource block groups (RBGs) including at least one enhanced physical downlink control channel (ePDCCH) PRB in accordance with an example;

15 FIG. 11 illustrates a block diagram of a resource allocation (RA) type 2 to allocate ten physical resource blocks (PRBs) including at least one enhanced physical downlink control channel (ePDCCH) PRB in accordance with an example;

FIG. 12 depicts a flow chart of a method for downlink (DL) grant validation in accordance with an example;

20 FIG. 13 depicts a flow chart of a method to receive a physical downlink shared channel (PDSCH) physical resource block (PRB) resource allocation (RA) in accordance with an example;

FIG. 14 depicts a flow chart of a method for uplink (UL) grant validation in accordance with an example;

25 FIG. 15 illustrates a block diagram of a node and a wireless device in accordance with an example; and

FIG. 16 illustrates a diagram of a wireless device in accordance with an example.

Reference will now be made to the exemplary embodiments illustrated, and specific language will be used herein to describe the same. It will nevertheless be 30 understood that no limitation of the scope of the invention is thereby intended.

DETAILED DESCRIPTION

Before the present invention is disclosed and described, it is to be understood that this invention is not limited to the particular structures, process

steps, or materials disclosed herein, but is extended to equivalents thereof as would be recognized by those ordinarily skilled in the relevant arts. It should also be understood that terminology employed herein is used for the purpose of describing particular examples only and is not intended to be limiting. The same
5 reference numerals in different drawings represent the same element. Numbers provided in flow charts and processes are provided for clarity in illustrating steps and operations and do not necessarily indicate a particular order or sequence.

EXAMPLE EMBODIMENTS

An initial overview of technology embodiments is provided below and then
10 specific technology embodiments are described in further detail later. This initial summary is intended to aid readers in understanding the technology more quickly but is not intended to identify key features or essential features of the technology nor is it intended to limit the scope of the claimed subject matter.

The communication of data on the physical downlink shared channel
15 (PDSCH) can be controlled via a control channel, referred to as a physical downlink control channel (PDCCH). The PDCCH can be used for downlink (DL) and uplink (UL) resource assignments, transmit power commands, and paging indicators. The PDSCH scheduling grant can be designated to a particular wireless device (e.g., UE) for dedicated PDSCH resource allocation to carry UE-
20 specific traffic, or it can be designated to all wireless devices in the cell for common PDSCH resource allocation to carry broadcast control information such as system information or paging.

In one example, the PDCCH and PDSCH can represent elements of a radio frame structure transmitted on the physical (PHY) layer in a downlink
25 transmission between a node (e.g., eNodeB) and the wireless device (e.g., UE) using a generic 3GPP long term evolution (LTE) frame structure, as illustrated in FIG. 1.

FIG. 1 illustrates a downlink radio frame structure type 2. In the example, a radio frame 100 of a signal used to transmit the data can be configured to have a
30 duration, T_f , of 10 milliseconds (ms). Each radio frame can be segmented or divided into ten subframes 110i that are each 1 ms long. Each subframe can be further subdivided into two slots 120a and 120b, each with a duration, T_{slot} , of 0.5 ms. The first slot (#0) 120a can include a legacy physical downlink control

channel (PDCCH) 160 and/or a physical downlink shared channel (PDSCH) 166, and the second slot (#1) 120b can include data transmitted using the PDSCH.

Each slot for a component carrier (CC) used by the node and the wireless device can include multiple resource blocks (RBs) 130a, 130b, 130i, 130m, and 5 130n based on the CC frequency bandwidth. The CC can have a carrier frequency having a bandwidth and center frequency. Each subframe of the CC can include downlink control information (DCI) found in the legacy PDCCH. The legacy PDCCH in the control region can include one to three columns of the first OFDM symbols in each subframe or RB, when a legacy PDCCH is used. The 10 remaining 11 to 13 OFDM symbols (or 14 OFDM symbols, when legacy PDCCH is not used) in the subframe may be allocated to the PDSCH for data (for short or normal cyclic prefix).

Each RB (physical RB or PRB) 130i can include 12 - 15kHz subcarriers 136 (on the frequency axis) and 6 or 7 orthogonal frequency-division multiplexing 15 (OFDM) symbols 132 (on the time axis) per slot. The RB can use seven OFDM symbols if a short or normal cyclic prefix is employed. The RB can use six OFDM symbols if an extended cyclic prefix is used. The resource block can be mapped to 84 resource elements (REs) 140i using short or normal cyclic prefixing, or the resource block can be mapped to 72 REs (not shown) using extended cyclic 20 prefixing. The RE can be a unit of one OFDM symbol 142 by one subcarrier (i.e., 15kHz) 146.

Each RE can transmit two bits 150a and 150b of information in the case of quadrature phase-shift keying (QPSK) modulation. Other types of modulation may be used, such as 16 quadrature amplitude modulation (QAM) or 64 QAM to 25 transmit a greater number of bits in each RE, or bi-phase shift keying (BPSK) modulation to transmit a lesser number of bits (a single bit) in each RE. The RB can be configured for a downlink transmission from the eNodeB to the UE, or the RB can be configured for an uplink transmission from the UE to the eNodeB.

Each wireless device may use at least one bandwidth. The bandwidth may 30 be referred to as a signal bandwidth, carrier bandwidth, or component carrier (CC) bandwidth, as illustrated in FIG. 2. For example, the LTE CC bandwidths can include: 1.4 MHz 310, 3 MHz 312, 5 MHz 314, 10 MHz 316, 15 MHz 318, and 20 MHz 320. The 1.4 MHz CC can include 6 RBs comprising 72 subcarriers. The 3

MHz CC can include 15 RBs comprising 180 subcarriers. The 5 MHz CC can include 25 RBs comprising 300 subcarriers. The 10 MHz CC can include 50 RBs comprising 600 subcarriers. The 15 MHz CC can include 75 RBs comprising 900 subcarriers. The 20 MHz CC can include 100 RBs comprising 1200 subcarriers.

5 The data carried on the PDCCH can be referred to as downlink control information (DCI). Multiple wireless devices can be scheduled in one subframe of a radio frame. Therefore, multiple DCI messages can be sent using multiple PDCCHs. The DCI information in a PDCCH can be transmitted using one or more control channel elements (CCE). A CCE can be comprised of a group of resource element groups (REGs). A legacy CCE can include up to nine REGs. Each REG
10 can be comprised of four resource elements (REs). Each resource element can include two bits of information when quadrature modulation is used. Therefore, a legacy CCE can include up to 72 bits of information. When more than 72 bits of information are needed to convey the DCI message, multiple CCEs can be
15 employed. The use of multiple CCEs can be referred to as an aggregation level. In one example, the aggregation levels can be defined as 1, 2, 4 or 8 consecutive CCEs allocated to one PDCCH.

 The legacy PDCCH can create limitations to advances made in other areas of wireless communication. For example, mapping of CCEs to subframes in
20 OFDM symbols is typically spread over the control region to provide frequency diversity. However, no beam forming diversity may be possible with the current mapping procedures.

 Moreover, the capacity of the legacy PDCCH may not be sufficient for advanced control signaling. For instance, networks may be configured as
25 heterogeneous networks (HetNets) that can include a number of different kinds of nodes in a single macro cell serving area. More wireless devices can be served simultaneously by macro and pico cells in the HetNet. The PDCCH can be designed to demodulate based on cell-specific reference signals (CRS), which can make fully exploring cell splitting gain difficult. The legacy PDCCH may not
30 be adequate to convey the information needed to allow a wireless device to take advantage of the multiple transmission nodes in the HetNet to increase bandwidth and decrease battery usage at the wireless device.

In addition, an increased capacity in the PDCCH can be useful in the use of multi-user multiple-input multiple-output (MU-MIMO), machine to machine communication (M2M), PDSCH transmission in a multicast/broadcast single-frequency network, and cross carrier scheduling. The use of UE specific reference signals (UERS) in PDCCH demodulation at the wireless device can allow the use of multiple nodes in the HetNet. Rather than relying on a single common reference symbol (e.g., CRS) for an entire cell, each reference symbol can be UE specific (e.g., UERS).

To overcome the limitations of the legacy PDCCH, an enhanced PDCCH (ePDCCH) can use the REs in an entire PRB or PRB pair (where a PRB pair is two contiguous PRBs using the same subcarrier's subframe), instead of just the first one to three columns of OFDM symbols in a first slot PRB in a subframe as in the legacy PDCCH. Accordingly, the ePDCCH can be configured with increased capacity to allow advances in the design of cellular networks and to minimize currently known challenges and limitations.

Unlike the legacy PDCCH, the ePDCCH can be mapped to the same REs or region in a PRB as the PDSCH, but in different PRBs. In an example, the PDSCH and the ePDCCH may not be multiplexed within a same PRB (or a same PRB pair). Thus if one PRB (or one PRB pair) contains an ePDCCH, the unused REs in the PRB (or PRB pair) may be blanked, since the REs may not be used for the PDSCH.

FIG. 3 illustrates 4 DCIs 182, 184, 186, and 188 of an ePDCCH in a PRB pair 128. Each DCI of the ePDCCH can be transmitted by at least one CCE, and each CCE can include a plurality of REGs, and each REG can include a plurality of REs. FIG. 3 illustrates a multiplexing pattern of an ePDCCH when multiple aggregation level one (AGL1) localized CCEs are multiplexed in one PRB pair. An aggregation level one CCE (e.g., a single CCE) can include a DCI, so four CCEs can include four separate DCIs. In another example (not shown), an aggregation level two CCE (e.g., two CCEs) can include one DCI. The PRB pair can also include legacy control 162 (e.g., legacy PDCCH) and reference signals, such as cell-specific reference signals (CRS) 170 and UE specific reference signals (UERS) 172 and 174, used for demodulation and channel estimation. In an

example, DCI 1 and DCI 2 can use UERS 172, which can be different from the UERS 174 used by DCI 3 and DCI 4.

The PRB or PRB pair can be used to support both localized ePDCCH and distributed ePDCCH transmissions. FIGS. 4 and 5 illustrate localized ePDCCH and distributed ePDCCH in a slot or a subframe. In a localized ePDCCH 332a-b, the entire CCE 310a-h may be within a PRB 330a and 330c (or PRB pair) within a subband 338a and 338c, as illustrated in FIG. 4. In an example, the REGs (or REs) of the localized CCE can be contiguous to each other, which may be followed by a subsequent CCE. In a distributed ePDCCH 324a-b, the REGs 340a-b, 342a-b, 344a-b, 346a-b, 348a-b, 350a-b, 352a-b, and 354a-b of the CCE 312a-b can be distributed over multiple PRBs 330b and 330d (or PRB pairs). The REG(s) 340a in one PRB 330b and the REG(s) 340b in another PRB 330d can form the CCE 312a for the DCI or the distributed ePDCCH. In distributed ePDCCH, the REGs for a CCE can be distributed over two or more PRBs (or two or more PRB pairs). In an example, the REGs of the CCEs used in the distributed ePDCCH can be distributed over different subbands 338b and 338d.

FIG. 5 provides another example of a localized ePDCCH and a distributed ePDCCH mapped into CCEs, REGs, and REs within a subframe. In the example of FIG. 5, each resource block pair can comprise two resource blocks (RB or PRB), each having the same subcarriers, located in a first and second slot in the subframe of a radio frame, as shown in FIG. 1. Each RB can include at least one CCE. The CCE may be in a defined location within the RB. However, the CCE may include REGs that are located throughout the resource block. Each REG may include four REs. However, based on system requirements, a REG may include more or less REs. In an example, the REs located in a REG can be contiguous in at least one of frequency and time. In another example, the REs located in a REG may be separated in time and/or frequency. The number of REGs in a CCE may be a fixed number, such as nine. Alternatively, the number of REGs may vary based on DCI data load requirements (i.e., the amount of DCI data), or other competing requirements in the RB, such as physical control format indicator channel (PCFICH) requirements, physical hybrid-ARQ indicator channel (PHICH) requirements, and resource symbol requirements for data allocated

within each resource block. The CCE may be mapped across a slot boundary in the physical resource block pair.

A localized ePDCCH 402 having aggregation level (AGL) one can be mapped to a single CCE, which can be mapped to a single RB, as shown in FIG. 5. Similarly, a localized ePDCCH 404 with an aggregation level of two may be mapped to two contiguous CCEs in a RB. For a distributed ePDCCH 406 and 408, the CCE(s) (e.g. CCE 1 and CCE N) can be mapped to a plurality of REGs in different RBs in different frequency carriers and subcarriers. For example, the REGs for the CCE N can be distributed in frequency. The frequency separation of the REGs can provide a frequency diversity gain. In an example, each REG in a CCE may be mapped to a separate RB, although more than one REG may be mapped to a same RB as another REG. A greater frequency diversity gain that can occur with widely distributed the REGs. The REGs in CCE 1 and CCE N may have the same distribution (shown) or different distribution (not shown) amongst RBs in a subframe. While the REGs illustrated in the distributed ePDCCH 406 and 408 are each shown to be in the same time position within a RB, for each respective CCE, a same time position within a RB for the distributed ePDCCH is not required. The distributed REGs in CCE 1 and CCE N may be in a different temporal location within a resource block. Each CCE in a subframe may have a same number of REGs or a different number of REGs. The distributed ePDCCH can have an aggregation level of one. The aggregation level of one implies that the DCI information can be mapped to a single CCE.

The distribution of the REGs in a CCE over frequency to different resource blocks in a subframe can provide an increase in frequency diversity gain. FIG. 5 illustrates a distributed ePDCCH 406 and 408 transmission.

In another example, when the ePDCCH has an aggregation level greater than one (e.g., aggregation level 2, 4, or 8) the CCE can include localized CCE or distributed CCEs. A localized CCE can be CCEs (for an ePDCCH with an aggregation level greater than one) that are contiguous to each other, which may be followed by a subsequent CCE in time or frequency. A distributed CCE can be CCEs (for an ePDCCH with an aggregation level greater than one) that are non-contiguous or CCEs distributed over multiple PRBs (or PRB pairs).

In another configuration, the localized ePDCCH and distributed ePDCCH can be multiplexed in one PRB pair in one subframe. Referring back to FIG. 3, different DCIs can be frequency division multiplexed (FDM) in a same PRB pair across two slots of a subframe. In an example, antenna ports 7, 8, 9, and/or 10
5 can be used in one PRB pair. In another example, one PRB pair can be divided into four CCEs to carry four DCIs with AGL1, as shown in FIG. 3. Each UERS port can be associated with one CCE for demodulation and/or channel estimation. In an example, two CCEs (e.g., DCIs) can share two UERS antenna ports 172 and 174.

10 CCE level frequency domain multiplexing can be used between localized CCEs and distributed CCEs, as previously illustrated in FIG. 5. The localized ePDCCH and distributed ePDCCH can use different transmission modes. For example, the localized ePDCCH can use beamforming and the distributed ePDCCH can use transmit diversity. Since at least two UERS ports may be
15 needed for transmit diversity, different transmission schemes may be used when a different number of distributed CCEs are used in one PRB pair.

For example, when one CCE is reserved for distributed ePDCCH transmission (e.g., Tx diversity) in one PRB pair, the other CCEs can be reserved for localized ePDCCH transmission. To illustrate the concept further,
20 beamforming can be applied on three UERS ports (e.g. UERS ports 7-9) for localized transmission and only one UERS port (e.g. UERS port 10) may be available for transmit diversity transmission. Since at least two UERS ports may be needed for transmit diversity, a wireless device can estimate a downlink channel by monitoring UERS port 10 and another UERS port $x \in \{7,8,9\}$ used for localized
25 transmission. A precoding vector w can be used by antenna port x . To provide minimal interference from the localized ePDCCH transmission, the precoding vector applied to UERS port 10 (for the distributed ePDCCH transmission) can be orthogonal to the precoding vector w . The precoding vector for the one UERS port (e.g. UERS port 10) used for the distributed ePDCCH transmission can be
30 represented by $orth(w)$ where $orth(w)$ is a precoding vector that is orthogonal to w . In an example, the precoding vectors w and $orth(w)$ can be included in a codebook for spatial multiplexing (e.g., beamforming) and correspond to a

feedback report, such as a precoding matrix indicator (PMI), a rank indicator (RI), or a channel quality indicator (CQI).

Using FIG. 3 as an illustration, DCI 1 182 can be transmitted in a distributed ePDCCH, and DCI 2 184, DCI 3 186, and DCI 4 188 can be transmitted in
5 localized ePDCCHs. The CCE of DCI 2 can be precoded with precoding vector w , and DCI 1 can be precoded with precoding vector $orth(w)$.

In another example where two or more CCEs are used for distributed ePDCCH transmission in one PRB pair, any two UERS ports (e.g., UERS ports 7, 8, 9 and/or 10) associated with the CCEs used for distributed ePDCCH
10 transmission can be used for transmit (Tx) diversity. The remaining CCEs in the PRB pair used for localized ePDCCH transmission can be transmitted using beamforming.

Using FIG. 3 as an illustration, DCI 1 182 and DCI 2 184 can be transmitted in a distributed ePDCCH where UERS ports 7 and 8 are associated with DCIs 1
15 and 2, and DCI 3 186 and DCI 4 188 can be transmitted in localized ePDCCHs where UERS ports 9 and 10 are associated with DCIs 3 and 4. If three CCEs are used for distributed ePDCCH transmission in one PRB pair, one CCE can be used for localized ePDCCH transmission. For example, DCI 1 182, DCI 2 184, and
20 DCI 3 186 can be transmitted in a distributed ePDCCH where UERS ports 7, 8, and 9 are associated with DCIs 1, 2, and 3, and DCI 4 188 can be transmitted in localized ePDCCHs where UERS port 10 is associated with DCI 4. The distributed ePDCCH(s) and localized ePDCCH(s) can use any UERS port number.

Transmit diversity can include the use of two or more physically separate
25 transmit antennas for signal transmission. Transmit diversity can be a type of antenna diversity, also known as space diversity, which two or more antennas can be used to improve the quality and reliability of a wireless link. Often, especially in urban and indoor environments, no clear line-of-sight (LOS) between transmitter and receiver may exist. Instead the signal may be reflected along multiple paths
30 before finally being received. Each of bounce of the signal reflection can introduce phase shifts, time delays, attenuations, and/or distortions that can destructively interfere with one another at an aperture of the receiving antenna.

Antenna diversity or transmit diversity can be effective at mitigating multipath interference.

Beamforming (also referred to as spatial multiplexing or spatial filtering) can be a signal processing technique used in antenna arrays for directional signal transmission or reception. Beamforming can be achieved by combining elements in the array in such a way that signals at particular angles experience constructive interference while others experience destructive interference. Beamforming can be used in transmission (or reception) to achieve spatial selectivity. Beamforming can improve an array gain, which can be a concentration of energy in one or more given directions via precoding. Beamforming can allow multiple users located in different directions to be served simultaneously (e.g., multi-user MIMO). In LTE, UERS can be used to enable a wireless device to demodulate beamformed data coherently. For example, an eNodeB may use a correlated array of physical antenna elements to generate a narrow beam in the direction of a particular UE. Such a beam can experience a different channel response between the eNodeB and UE, thus UE-specific RSs (UERS) can be used to enable the UE to demodulate the beamformed data coherently. For closed-loop beamforming, a wireless device can provide feedback based on the received channel including the UERS. The feedback can include a precoding matrix indicator (PMI), a rank indicator (RI), or a channel quality indicator (CQI). Open-loop beamforming can have limited feedback relative to closed-loop beamforming.

The use of ePDCCH can also modify PDCCH validation for semi-persistent scheduling (SPS). SPS enables radio resources to be semi-statically configured and allocated to a wireless device for a longer time period than one subframe, avoiding the need for specific downlink assignment messages or uplink grant messages over the PDCCH for each subframe. SPS can be useful for services such as voice over internet protocol (VoIP) for which the data packets are small, periodic and semi-static in size. For services like VoIP, the timing and amount of radio resources needed for transmissions can be predictable. Thus, the overhead of the PDCCH (e.g., ePDCCH) can be significantly reduced compared to dynamic scheduling. SPS can be configured by upper layer signaling, such as radio resource control (RRC) signaling, which can indicate the interval at which the radio resources are periodically assigned.

A semi-persistent scheduling (SPS) cell-radio network temporary identifier (C-RNTI) can be used in SPS. The SPS C-RNTI of the scheduling messages can be transmitted on the PDCCH for semi-persistently scheduled PDSCH data transmissions. The SPS C-RNTI allows the wireless device (e.g., UE) to
5 differentiate SPS messages from dynamic scheduling messages identified by a C-RNTI. The identifier (i.e. SPS C-RNTI) can be transmitted as a scrambling code applied to the cyclic redundancy check (CRC) of the PDCCH transmission. Dynamic scheduling can provide downlink assignment messages for an allocation of downlink transmission resources and uplink grant messages for the allocation
10 of uplink transmission resources, which can be valid for specific single subframes. Dynamic scheduling can be efficient for bursty and dynamic rate traffic, such as transmission control protocol (TCP) and signaling radio bearer (SRB) service types.

Cyclic redundancy check (CRC) can be an error detecting code appended
15 to a block of data to be transmitted. The value of the CRC can be calculated from the block of data. The length of the CRC can determine the number of errors which can be detected in the block of data on reception of the data. A CRC may not be able to correct errors or determine which bits are erroneous.

Because an activation of SPS can take longer than dynamic scheduling,
20 the CRC (e.g., virtual CRC) used in SPS can generate CRC false positives, which can be much more harmful than dynamic scheduling. So as a result, additional PDCCH validation procedures can be used for SPS C-RNTI masked scheduling. A false positive error can be a result that indicates a given condition has been fulfilled, when the condition actually has not been fulfilled. For example, a false
25 positive can occur when the CRC should generate an error, but does not generate an error.

Various differences exist between the ePDCCH and the legacy PDCCH. One difference between ePDCCH and the legacy PDCCH is that ePDCCH can be FDM with the PDSCH with a PRB granularity (as illustrated in FIG. 6-7), but the
30 legacy PDCCH 160 can be time division multiplexed (TDM) with PDSCH 166 with OFDM symbol granularity (as illustrated in FIG. 1). The difference between the ePDCCH and the legacy PDCCH can be utilized to create additional PDCCH validation for SPS C-RNTI masked scheduling.

A wireless device can determine the PRB pairs configured for ePDCCH before receiving ePDCCH transmitted DCIs. In an example, the wireless device can determine the PRB pairs configured for ePDCCH via high layer signaling, such as RRC signaling. In an example, the ePDCCH and the PDSCH can be
5 frequency division multiplexed (FDM) at a PRB pair level. FIG. 3 illustrates different DCIs FDM in one PRB pair. In another example, the PDSCH and the ePDCCH may not be multiplexed within a same PRB (or a same PRB pair), so ePDCCH and PDSCH may not exist in a same PRB pair.

Resource allocation signaling in the DCI can indicate which PRBs are
10 allocated to PDSCH. If ePDCCH PRBs are not allowed for PDSCH transmission, the wireless device can detect an incorrect DCI if the resource allocation signaling still indicates ePDCCH PRB for a PDSCH transmission. In legacy PDCCH, since the granularity is OFDM symbol based instead of PRB based, and resource allocation is based on PRB, a check of the DCI may not be needed for the legacy
15 PDCCH.

In an example, the PDCCH validation for SPS C-RNTI masked scheduling can include the wireless device performing an additional validation for ePDCCH carried DCIs. For example, if a DCI uses resource allocation (RA) type 0 resource block group (RBG) based scheduling and if the PDSCH allocation contains one
20 RBG which includes (or overlaps with) a PRB where the ePDCCH is transmitted, the wireless device can exclude (or deduct) at least one ePDCCH PRB from the PDSCH PRB resource allocation. In one option, the wireless device can exclude the ePDCCH PRBs (e.g., ePDCCH PRB pairs) for the wireless device from a PDSCH PRB allocation. In another option, the wireless device can exclude all the
25 ePDCCH PRBs (e.g., ePDCCH PRB pairs for all wireless devices) in a same subframe from a PDSCH PRB allocation. In other words, the wireless device can exclude all PRB pairs configured for ePDCCH in the same subframe where ePDCCH is transmitted.

In resource allocations of type 0, a bitmap can indicate the resource block
30 groups (RBGs) which can be allocated to a scheduled wireless device, where an RBG can be a set of consecutive PRBs in frequency. The RBG size P can be a function of the downlink system bandwidth N_{RB}^{DL} . The RBG size P can be the

number of PRBs within a RBG. In an example, the total number of RBGs N_{RBG} for downlink system bandwidth of N_{RB}^{DL} is given by $N_{RBG} = \lceil N_{RB}^{DL} / P \rceil$. For a downlink system bandwidth of 10 PRBs or less (e.g., 1.4 MHz) the RBG size P can be one PRB per RBG. For a downlink system bandwidth of 11-26 PRBs (e.g., 3 or 5 MHz) the RBG size P can be two PRBs per RBG. For a downlink system bandwidth of 27-63 PRBs (e.g., 10 MHz) the RBG size P can be three PRBs per group. For a downlink system bandwidth of 64-110 PRBs (e.g., 15 or 20 MHz) the RBG size P can be four PRBs per RBG.

FIG. 6 illustrates a subframe (or slot) where a RA type 0 is used with a downlink system bandwidth of 10 MHz (e.g., 50 PRBs; see 316 of FIG. 2). The subframe can include RBGs 222a-b with a plurality PRBs 230a-f and 236. A RB group (RBG) can include multiple RBs that contain ePDCCH PRBs. The subframe frame can be configured for PDSCH 202 PRBs 230a,c-f and ePDCCH 212 PRBs 236. The wireless device can exclude the ePDCCH 212 from the PDSCH resource allocation when the ePDCCH PRB is for the wireless device or the wireless device can exclude the ePDCCH 212 from the PDSCH resource allocation for all ePDCCH PRBs within the subframe.

In another example, if a DCI uses RA type 1 PRB based scheduling and if the PDSCH allocation contains one PRB which includes (or overlaps with) a PRB where the ePDCCH is transmitted, the wireless device can exclude (or deduct) at least one ePDCCH PRB from the PDSCH PRB resource allocation. In one option, the wireless device can exclude the ePDCCH PRBs (e.g., ePDCCH PRB pairs) for the wireless device from a PDSCH PRB allocation. In another option, the wireless device can exclude all the ePDCCH PRBs (e.g., ePDCCH PRB pairs for all wireless devices) in a same subframe from a PDSCH PRB allocation.

In resource allocations of type 1, individual PRBs can be addressed within a subset of the PRBs available. The bitmap used for RA type 1 can be slightly smaller than for RA type 0, since some bits can be used to indicate which subset of the RBG is addressed, and a shift in the position of the bitmap. The total number of bits (including additional flags used for the indications described) can be similar to the bit used for RA type 0. RA type 1 can provide flexibility in

spreading resources across the frequency domain to exploit frequency diversity and also allocate resources in the granularity of one PRB.

FIG. 7 illustrates a subframe (or slot) where a RA type 1 is used with a downlink system bandwidth of 15 or 20 MHz (e.g., 75 or 100 PRBs; see 318 or 5 320 of FIG. 2), where a virtual RBs (VRBs) are from one of P RBG subsets. The subframe can include a plurality PRBs 230c,e,g and 232. The subframe frame can be configured for PDSCH 202 PRBs 230c,e,g and ePDCCH 210 PRBs 236. The wireless device can exclude the ePDCCH 210 from the PDSCH resource allocation when the ePDCCH PRB is for the wireless device or the wireless device 10 can exclude the ePDCCH 210 from the PDSCH resource allocation for all ePDCCH PRBs within the subframe.

Similar to RA type 0 and RA type 1, if a DCI uses RA type 2 contiguous PRB based scheduling and if the PDSCH allocation contains one or more PRB which includes (or overlaps with) PRBs where the ePDCCH is transmitted, the 15 wireless device can exclude (or deduct) at least one ePDCCH PRB from the PDSCH PRB resource allocation. In one option, the wireless device can exclude the ePDCCH PRBs (e.g., ePDCCH PRB pairs) for the wireless device from a PDSCH PRB allocation. In another option, the wireless device can exclude all the ePDCCH PRBs (e.g., ePDCCH PRB pairs for all wireless devices) in a same 20 subframe from a PDSCH PRB allocation.

In resource allocations of type 2, the resource allocation information indicates a contiguous set of PRBs, using either localized or distributed mapping as indicated by a 1-bit flag in the resource allocation message. PRB allocations may vary from a single PRB up to a maximum number of PRBs spanning the 25 downlink system bandwidth.

In another example, a specification, such as the LTE specification can restrict that an ePDCCH PRB may not be used for PDSCH transmission or used in a PDSCH allocation, which can allow for an additional validation because the wireless device can verify if ePDCCH PRB is included in resource allocation 30 signaling in DCI.

In another configuration, when RA type 0, RA type 1, and RA 2 is used, a wireless device can restrict an ePDCCH PRB being used in the RA. In an example, an ePDCCH PRB for the wireless device may not be in the PDSCH

PRBs allocated to the wireless device. In another example, all the ePDCCH PRBs may not be allowed to be in the PDSCH PRBs allocated or transmitted as a PDSCH.

5 If the ePDCCH validation is achieved, the wireless device can consider the received DCI information accordingly as a valid semi-persistent activation or release. If the ePDCCH validation is not achieved, the received DCI format can be considered by the wireless device as having been received with a non-matching CRC.

10 Since ePDCCH and PDSCH may not be permitted to co-exist in the same PRB pair, and if the wireless device (e.g., UE) receives a DL grant allocating multiple PRB pairs which contains the ePDCCH PRB pairs, those ePDCCH PRB pairs can be rate matched from the PDSCH transmission. The DCI may be assumed to be C-RNTI masked.

15 Rate matching (RM) can be a process that adapts the code rate of data transmissions such that the number of information and parity bits to be transmitted matches a resource allocation. In an example, the RM process can use a circular buffer to either repeat bits to decrease the code rate or puncture bits to increase the code rate.

20 When RA type 1 signaling is used to allocate PDSCH and because RA type 1 can allocate PRBs with one PRB granularity, allocating PRBs containing the DL grant (e.g., PDCCH) as PDSCH PRBs, as illustrated in FIG. 8, can result in the same transmitted PDSCH PRBs as not allocating those PRBs containing the DL grant (e.g., PDCCH), as illustrated in FIG. 9.

25 For example, in FIG. 8, a node (e.g., eNB) uses RA type 1 to allocate six PRBs 240a-b as PDSCH PRBs and two PRBs 250g-h overlap with ePDCCH PRBs 220. Thus the wireless device can rate match around (or exclude) the two ePDCCH PRBs 250g-h and the final PRBs used for PDSCH transmission can be four PRBs (RBG 9 and 12 (224j and 224m) excluding PRBs 27 and 36 (250g-h)).

30 In FIG. 9, the node uses RA type 1 to allocate four PRBs 242a-b as PDSCH PRBs and no PRBs are overlapping with ePDCCH PRBs 220 from where wireless device receives the DL grant. Thus, the effective PRBs used for PDSCH can be the same in both FIGS. 8 and 9. Therefore, the wireless device behavior when receiving RA type 1 which allocates PRBs containing the DL grant can be defined

(e.g., the allocation including the DL grant PRBs, or the allocation excluding the DL grant PRBs).

FIGS. 8-9 illustrate PRB bundling or resource block grouping for a system bandwidth of 10 MHz (e.g., 50 PRBs 252a-b; see 316 of FIG. 2) with 4 PRBs
5 250e-h allocated for ePDCCH and the remaining 46 PRBs (or RBG 224a-q
excluding PRBs 250e-h) allocated to PDSCH. Each RBG can be allocated to a
subset 0, 1, or 2 (226a-c). In an example, each subset can represent a cell (e.g.,
cell A, B, or C). In FIGS. 8-9, the 50 PRBs can be represented by PRB 0-23 252a
(for PRBs from PRB 0 250a to PRB 23 250b) and PRB 24-49 252b (for PRBs
10 from PRB 24 250c to PRB 49 250d).

Similarly when the wireless device receives RA type 0 allocating one RBG
and the ePDCCH carrying the DL grant spans all the PRBs in the RBG, the
wireless device behavior can also be defined. For example, FIG. 10 illustrates a
node using RA type 0 to allocate three RBGs 244a-c as PDSCH PRBs and one of
15 the ePDCCH 250i-j which carries the DL grant spans one of the RBGs 226e or
244a. The RA type 0 allocation illustrated in FIG. 10 can occur less frequently
than RA type 1 allocation illustrated in FIGS. 8-9 because RA type 0 is allocated to
PRBs by RBGs using a bitmap.

FIG. 10 illustrates PRB bundling or resource block grouping for a system
20 bandwidth of 5 MHz (e.g., 25 PRBs 254; see 314 of FIG. 2) with 2 PRBs 250i-j
allocated for ePDCCH and the remaining 23 PRBs (or RBG 226a-d and f-m)
allocated to PDSCH. The 25 PRBs can be represented by PRB 0-24 254 (for
PRBs from PRB 0 250a to PRB 24 250c). FIG. 11 illustrates a similar PRB
bundling configuration as FIG. 10 with a few variations as noted below.

25 For RA type 2 when the node allocates PDSCH PRBs using ePDCCH
PRBs for a start PRB index and an end PRB index, the wireless device behavior
can be defined for the starting and ending PRBs using ePDCCH PRBs. For
example, FIG. 11 illustrates a node allocating 10 PRBs 246 as PDSCH PRBs for
using RA type 2. The starting two PRBs 250i-j and the ending one PRB 250k
30 overlaps with ePDCCH PRBs 220 which contains the DL grant.

In an example, when the wireless device (e.g., UE) receives a DL grant
masked with C-RNTI having RA type 0, 1, or 2 which contains ePDCCH PRBs
that carries the DL grant, as shown in FIGS. 10, 8, and 11, respectively, the

received DL grant format can be considered by the wireless device as having been received with a non-matching CRC.

In another example, the wireless device (e.g., UE) receives a DL grant masked with C-RNTI having RA type 1 and RA type 0 with RBG size equal to one
5 1 PRB, the DL grant format can be considered by the wireless device as having been received with a matching CRC under some scenarios.

For example, the ePDCCH containing the DL grant can fall in the same precoding resource block group (PRG) as the PDSCH. If ePDCCH uses localized transmission, the node can apply the same beamforming weights to ePDCCH and
10 a first layer of PDSCH. For the ePDCCH containing the DL grant and the PDSCH in the same PRG, the wireless device can use both UERS and the decoded ePDCCH in the ePDCCH PRB as additional decoding RS to decode the PDSCH in the same PRG. Significant system performance gain can be achieved in for the ePDCCH and the PDSCH in the same PRG. The node may use different multi-
15 user multiple-input multiple-output (MU-MIMO) transmissions for ePDCCH and PDSCH, which can cause a power ratio between UERS in ePDCCH PRB and UERS in PDSCH PRB unknown to the wireless device. Though blind decoding can be used, additional signaling (e.g., RRC signaling) can reduce the implementation complexity of accounting for the ePDCCH and the PDSCH in the
20 same PRG. In an example, after receiving such a DL grant and the allocated PDSCH PRBs overlaps with ePDCCH PRBs, the wireless device may assume the same precoding vector apply to ePDCCH UERS and the first layer of PDSCH.

The following provides additional details on the ePDCCH containing the DL grant and the PDSCH in the same PRG. The PRBs within the PRG can use a
25 same precoder or a same precoding matrix. A precoding vector for ePDCCH UERS can be orthogonal to a precoding vector for PDSCH UERS. In an example, the precoder can provide for transmit beamforming and power allocation across the transmitted streams. The PRG size can vary based on the system bandwidth, similar to the RBG size. The PRG size can be the number of PRBs within a PRB
30 bundle or PRG. For a system bandwidth of less than 10 PRBs (e.g., 1.4 MHz) the PRG size P' can be one PRB per group. For a system bandwidth of 11-26 PRBs (e.g., 3 or 5 MHz) or 64-110 PRBs (e.g., 15 or 20 MHz) the PRG size P' can be

two PRBs per group. For a system bandwidth of 27-63 PRBs (e.g., 10 MHz) the PRG size P' can be three PRBs per group.

In another example, the node (e.g., eNB) can transmit to multiple wireless devices via a MU-MIMO mode which can be transparent to a wireless device (e.g., the spatial multiplexing capacity on the PDSCH can be unknown to the wireless device even after DCI decoding). With the MU-MIMO mode, a reference signal (RS) power imbalance can occur between the ePDCCH PRB and the PDSCH PRB even when the wireless device detects that both the ePDCCH and the PDSCH are transmitted with a same rank. The rank of the transmission can be the number of layers transmitted. A layer can be number of different data streams generated by spatial multiplexing, where each data stream can be transmitted on a transmit antenna of the node.

In an example, when MU-MIMO is applied, the node can indicate to the wireless device to exclude the ePDCCH PRB from the PRG. The indication to exclude the ePDCCH PRB from PRG can be transmitted to the wireless device via radio resource control (RRC) signaling. Alternatively, the node can de-boost the power of UERS in ePDCCH PRB for MU-MIMO to keep a similar energy per resource element (EPRE) ratio between the UERS in ePDCCH PRB and the UERS in PDSCH PRB. The power of the UERS in ePDCCH PRB can be de-boosted by a power offset $\delta_{\text{power-offset}}$.

Like MU-MIMO, random beamforming or closed loop beamforming can be transparent to the wireless device. The wireless device can apply the PRG to the ePDCCH PRB and the PDSCH PRB for random or closed loop beamforming when the node uses a same precoding vector for the ePDCCH PRB as the PDSCH PRB. When the node uses different precoding vectors between the ePDCCH PRB and the PDSCH PRB, the node can transmit an indication to the wireless device to exclude ePDCCH PRB from the PRG process, and the wireless device can exclude ePDCCH PRB from the PRG.

In another example, transmit diversity can be used for ePDCCH transmission containing the DL grant. The wireless device can apply PRG to the ePDCCH transmitted with transmit diversity and the PDSCH transmitted with beamforming. The wireless device can apply PRG to the ePDCCH PRB and the

PDSCH PRB for transmit diversity and/or beamforming when the node uses a same precoding vector for the ePDCCH PRB as the PDSCH PRB. When the node uses different precoding vectors between the ePDCCH PRB and the PDSCH PRB, the node can transmit an indication to the wireless device to
5 exclude ePDCCH PRB from the PRG process, and the wireless device can exclude ePDCCH PRB from the PRG.

In an example, the ePDCCH containing the DL or UL grant can fall in a same precoding within the assigned eCCEs to a wireless device (e.g., UE). When the wireless device attempts blind decoding for ePDCCH detection, the wireless
10 device can assume a same precoding matrix is applied within an eCCE aggregation level. In particular, this invention can be applied to localized ePDCCH transmission. If the aggregation level for the wireless device is 8 with localized ePDCCH transmission, the node (e.g., eNB) can apply the same precoding matrix for those 8 eCCEs and the wireless device can assume the
15 same precoding matrix for those 8 eCCEs in blind decoding attempts so that the wireless device can enhance the channel estimation performance in ePDCCH detection by applying channel estimation window within up to the 8 eCCE indices.

For semi-persistent scheduling (SPS), the ePDCCH PRB(s) can include SPS activate DL grant. The SPS activate can initiate the SPS until the SPS is
20 released for the wireless device. During SPS, additional subsequent DL grants may not be needed by the wireless device.

In a configuration, when the wireless device receives SPS activate DL grant masked with SPS-C-RNTI in subframes having RA type 0, 1, or 2 which contain ePDCCH PRBs that carries a DL grant, as shown in FIGS. 10, 8, and 11,
25 respectively, the wireless device can validate or invalidate the SPS activate DL grant format sent. FIG. 10 illustrates the ePDCCH PRBs 250i-j which carries the DL grant spanning at least one of the RBGs 226e or 244a for RA type 0. FIG. 8 illustrates the PDSCH PRB allocation 240a-b for RA type 1 with ePDCCH PRBs 250g-h which carries the DL grant included within the PDSCH PRB allocation.
30 FIG. 11 illustrates the PDSCH PRB allocation for RA type 2 using ePDCCH PRBs which carries the DL grant for a start PRB index 250i-j or an end PRB index 250k.

In a first example (option a) when the wireless device receives SPS activate DL grant masked with SPS-C-RNTI, the received DL grant format can be

considered by the wireless device as having been received with a non-matching CRC (e.g., invalid for RA type 0, 1, or 2, as illustrated in FIGS. 10, 8, and 11, respectively). In a second example (option b) when the wireless device receives SPS activate DL grant masked with SPS-C-RNTI, the received DL grant format
5 can be considered by the wireless device as a valid SPS activate DL grant and the wireless device can perform PDSCH rate matching around the PRBs containing the DL grant (i.e., the PDSCH PRBs can be rate matched in the same subframe to the ePDCCH PRBs containing the DL grant) for RA type 0, 1, or 2, as illustrated in FIGS. 10, 8, and 11, respectively.

10 The wireless device can be configured with for a SPS activate DL grant and other ePDCCH PRBs in a same subframe. Alternatively, the wireless device may not be configured with for a SPS activate DL grant and other ePDCCH PRBs in the same subframe.

If the second example (option b above) is selected and when the wireless
15 device receives a SPS PDSCH scheduled by a configured DL assignment (or previous SPS activate DL grant) for RA type 0, 1, or 2, as illustrated in FIGS. 10, 8, and 11, respectively, which contains ePDCCH PRBs that carries the DL grant, at least three sub-options can occur. A first sub-option (option b-1) can be that the ePDCCH PRBs containing the original SPS activate DL grant can be considered
20 (i.e., treated) as PDSCH PRBs for validation purposes, if option b is selected in the subframe when SPS activate DL grant is received and if the wireless device is configured with ePDCCH PRBs in the same subframe. A second sub-option (option b-2) can be that the ePDCCH PRBs containing the original SPS activate
25 DL grant can be rate matched from the PDSCH PRBs (i.e., i.e., the ePDCCH PRBs containing the original SPS activate DL grant can be rate matched in the same subframe to the PDSCH PRBs), if option b is selected in the subframe when SPS activate DL grant is received and if the wireless device is configured with ePDCCH PRBs in the same subframe. In option b-2, the wireless device can rate match the PRBs (or treat the PRBs as rate matched) in the first SPS activate
30 subframe, though the node may not actually use those PRBs to transmit a grant (DL or UL) to any wireless device.

A third sub-option (option b-3) can be that the ePDCCH PRBs containing the original SPS activate DL grant can be considered as (i.e., treated) PDSCH

PRBs for validation purposes, if option b is selected in the subframe when SPS activate DL grant is received and if the wireless device is not configured with ePDCCH PRBs in the same subframe.

The wireless device (e.g., UE) behavior when receiving UL grant in subframes when the wireless device receives a PDSCH without a corresponding ePDCCH (i.e. SPS-PDSCH) which is configured by a corresponding recent SPS activation DCI can also be defined. For example, in the subframes when the wireless device receives a PDSCH without a corresponding ePDCCH configured by a corresponding most recent SPS activation DCI, the wireless device may not expect to receive a UL grant of ePDCCH in any of the PRBs for the PDSCH without a corresponding ePDCCH or the wireless device may skip the blind decoding attempt of a UL grant for the aggregation levels which contain any of the PRBs for the PDSCH without a corresponding ePDCCH. However, when the wireless device detects a DL assignment in a user equipment (UE) search space for the wireless device in the subframe with the configured SPS-PDSCH PRBs (i.e. SPS-PDSCH can be overridden by DL assignments to the wireless device), the wireless device may expect to receive a UL grant of ePDCCH in any of the SPS-PDSCH PRBs or the wireless device may not skip the blind decoding attempt of a UL grant for aggregation levels which contain any of the SPS-PDSCH PRBs.

The following considers some examples of RA type 0, 1, and 2 not illustrated by FIGS. 10, 8, and 11. For the ePDCCH PRBs which carries the DL grant that do not span (i.e., fill) at least one of the RBGs for RA type 0, the DL grant format can be considered by the wireless device as having been received with a matching CRC. For the RA type 1 where the ePDCCH PRBs which carries the DL grant is excluded from the PDSCH PRB allocation (FIG. 9), the DL grant format can be considered by the wireless device as having been received with a matching CRC. When the PDSCH PRB allocation for RA type 2 does not use the ePDCCH PRBs which carries the DL grant for either a start PRB index or an end PRB index, the DL grant format can be considered by the wireless device as having been received with a matching CRC.

Another example provides a method 500 for downlink (DL) grant validation, as shown in the flow chart in FIG. 12. The method may be executed as instructions on a machine, where the instructions are included on at least one

computer readable medium or one non-transitory machine readable storage medium. The method includes the operation of receiving from a node a downlink grant masked with a cell radio network temporary identifier (C-RNTI) for a resource allocation (RA) including an enhanced physical downlink control channel (ePDCCH) physical resource block (PRB) carrying the downlink grant, as in block 510. The operation of validating a downlink control information (DCI) format of the downlink grant follows, as in block 520. The next operation of the method can be determining that the downlink grant is received with a non-matching cyclic redundancy check (CRC) when the DCI format is not validated, as in block 530.

10 In an example, the operation of validating the DCI format can validate the DCI format when RA type 0 or RA type 1 has a resource block group (RBG) size equal to one PRB. In a configuration, the method can further include decoding ePDCCH user equipment-specific reference signal (UERS) and the PDSCH UERS using a same precoding matrix where a precoding vector for ePDCCH UERS is orthogonal to a precoding vector for another ePDCCH UERS in a same PRB. The same precoding vector can be applied for both ePDCCH and a first layer of PDSCH in the same PRB bundling window when the DCI allocates PRBs excluded from PDSCH decoding and the node avoided allocating the excluded PRBs in RA signaling. Stated another way, if the DCI is allocating PRBs which the UE needs to exclude from PDSCH decoding and eNB can avoid allocating those PRBs in the RA signaling, the UE can assume the same precoding vector is applied for both ePDCCH and the first layer of PDSCH in the same PRB bundling window. The method can further include: Demodulating one ePDCCH using one UERS antenna port X; and demodulating another ePDCCH using two UERS antenna ports X and Y. The one ePDCCH can be localized, and the another ePDCCH can be distributed. The UERS antenna ports X and Y can belong to a same code division multiplexing (CDM) group.

In a configuration, the downlink grant can be a semi-persistent scheduling (SPS) activate downlink grant, and the SPS activate downlink grant can be masked with an SPS-C-RNTI. In an example, the operation of validating the DCI format can fail (i.e., DCI format can be invalid) for RA type 0, RA type 1, and RA type 2. In another example, the operation of validating the DCI format can validate the DCI format, and the method can further comprise the operation of

physical downlink shared channel (PDSCH) rate matching to the PRBs including the SPS activate downlink grant. The method can further include decoding the ePDCCH PRB as a PDSCH PRB, or the method can further include rate matching the ePDCCH PRB including the SPS activate downlink grant from PDSCH PRBs.

5 In another example, the operation of validating the DCI format can fail when an uplink grant is included in a semi-persistent scheduling (SPS) physical downlink shared channel (PDSCH) PRB of the resource allocation.

Another example provides a method 600 to receive a physical downlink shared channel (PDSCH) physical resource block (PRB) resource allocation (RA),
10 as shown in the flow chart in FIG. 13. The method may be executed as instructions on a machine, where the instructions are included on at least one computer readable medium or one non-transitory machine readable storage medium. The method includes the operation of receiving from a node a PDSCH PRB resource allocation, wherein an enhanced physical downlink control channel
15 (ePDCCH) is in a resource block group (RBG) or contiguous PRBs associated with the PDSCH PRB resource allocation, as in block 610. The operation of excluding the at least one ePDCCH PRB from the PDSCH PRB resource allocation so the at least one ePDCCH PRB is not part of the PDSCH PRB resource allocation follows, as in block 620.

20 The resource allocation type for the resource allocation can include RA type 0 resource block group (RBG) based scheduling, RA type 1 PRB based scheduling using virtual resource blocks (VRBs), or RA type 2 contiguous PRB based scheduling using VRBs. The at least one ePDCCH PRB can include at least one of a localized ePDCCH and a distributed ePDCCH. The at least one
25 ePDCCH PRB can include a PRB pair. The PRB pair can be two continuous PRBs using the same subcarriers in a subframe.

Another example provides a method 800 for uplink (UL) grant validation, as shown in the flow chart in FIG. 14. The method may be executed as instructions on a machine, where the instructions are included on at least one computer
30 readable medium or one non-transitory machine readable storage medium. The method includes the operation of receiving, from a node at a wireless device, a semi-persistent scheduling (SPS) activation downlink control information (DCI), wherein cyclic redundancy check (CRC) bits for an enhanced physical downlink

control channel (ePDCCH) is masked with a SPS cell radio network temporary identifier (C-RNTI), as in block 810. The operation of receiving from a node a physical downlink shared channel (PDSCH) without a corresponding enhanced physical downlink control channel (ePDCCH) in a subframe follows, as in block 5 820. The next operation of the method can be validating an uplink grant in a physical resource block (PRB) for the PDSCH without the corresponding ePDCCH, as in block 830.

In an example, the operation of validating the uplink grant can further include: Being aware of no UL grant; and skipping a blind decode for the UL grant 10 in the PRB for the PDSCH without the corresponding ePDCCH when the wireless device does not detect an ePDCCH downlink (DL) assignment in the subframe. In another configuration, the operation of validating the uplink grant can further include: Detecting an ePDCCH downlink (DL) assignment in a common or user equipment (UE) search space for the wireless device in the subframe; and blind 15 decoding of the UL grant including the PDSCH PRB without the corresponding ePDCCH.

FIG. 15 illustrates an example node 710 and an example wireless device 720. The node can include a node device 712. The node device or the node can be configured to communicate with the wireless device. The node device can be 20 configured for transmitting a distributed control channel element (CCE) for an enhanced physical downlink control channel (ePDCCH) and a localized CCE in a physical resource block (PRB) pair. The node device can include a transceiver module 716 and a precoder 718. The precoder can be configured to precoder at least one distributed CCE and at least one localized CCE for the PRB pair. The 25 transceiver module can be configured to transmit to the wireless device the at least one distributed CCE for transmit diversity using at least two user equipment-specific reference signal (UERS) ports and transmit the at least one localized CCE in the PRB pair. The at least two UERS ports are used to transmit two CCEs.

In an example, the PRB pair can include one distributed CCE and at least 30 three localized CCE. A precoding vector w for beamforming can be applied to a UERS port for one of the localized CCE and a precoding vector $orth(w)$ for transmit diversity can be applied to a UERS port for the distributed CCE. The precoding vector $orth(w)$ can be orthogonal to the precoding vector w , and w and

$orth(w)$ can each be an $N_t \times 1$ vector, where N_t indicates the number of node transmit antennas. The precoder 718 can be configured to precode the localized CCE with precoding vector w and the distributed CCE with precoding vector $orth(w)$. The transceiver module 716 can be configured to transmit the localized
5 CCE and the distributed CCE using at least two UERS ports.

In another example, the PRB pair can include at least two distributed CCE and at least one localized CCE. The precoder 718 can be configured to precode the at least two distributed CCEs using at least two precoding vectors for transmit diversity. The transceiver module 716 can be configured to transmit the
10 distributed CCEs using at least two UERS ports. The at least two precoding vectors for transmit diversity can include precoding vectors w_1 , w_2 , w_3 , and/or w_4 , where each precoding vector is an $N_t \times 1$ vector, and N_t indicates the number of node transmit antennas. In an example, the UERS ports can include UERS ports 7, 8, 9, and/or 10. In another example, up to sixteen different precoding vectors
15 may be used.

In another example, the node device 712 can be configured for physical downlink shared channel (PDSCH) physical resource block (PRB) allocation with at least one enhanced physical downlink control channel (ePDCCH). The node device can include a processing module 714 and a transceiver module 716. The
20 processing module can be configured to generate a PDSCH PRB resource allocation (RA) including at least one ePDCCH PRB. The transceiver module can be configured to transmit the PDSCH PRB RA via downlink control information (DCI) carried by an ePDCCH. In another example, the transceiver module can be configured to transmit PRB configuration information for the ePDCCH via radio
25 resource control (RRC) signaling before transmitting the PDSCH PRB RA.

In another example, the node device 712 can be configured to map physical downlink shared channel (PDSCH) in resource elements. The node device can include a processing module 714 and a transceiver module 716. The processing module can be configured to map a PDSCH into physical resource
30 blocks (PRBs) for a resource allocation (RA). For the example, an enhanced physical downlink control channel (ePDCCH) in a resource block group (RBG) or contiguous PRBs associated with the PDSCH is not part of the resource allocation. The transceiver module can be configured to communicate with a

wireless device and to send a resource allocation type for the resource allocation. In an example, the resource allocation type for the resource allocation can include RA type 0 resource block group (RBG) based scheduling, RA type 1 PRB based scheduling using virtual resource blocks (VRBs), or RA type 2 contiguous PRB based scheduling using VRBs.

The node 710 can include a base station (BS), a Node B (NB), an evolved Node B (eNB), a baseband unit (BBU), a remote radio head (RRH), a remote radio equipment (RRE), or a remote radio unit (RRU).

The wireless device 720 can include a transceiver module 724 and a channel estimator 726. The wireless device can be configured to receive a distributed control channel element (CCE) and a localized CCE in a physical resource block (PRB) pair for at least one enhanced physical downlink control channel (ePDCCH). The transceiver module can be configured to receive at least one distributed CCE for transmit diversity and at least one localized CCE in the PRB pair. The at least two user equipment-specific reference signal (UERS) ports can be used to receive two CCEs. The channel estimator can be configured to monitor the at least two UERS ports to estimate a downlink channel.

In an example, the PRB pair can include one distributed CCE and at least three localized CCE. A precoding vector w for beamforming can be applied to a UERS port for one of the localized CCE and a precoding vector $orth(w)$ for transmit diversity can be applied to a UERS port for the distributed CCE. The precoding vector $orth(w)$ can be orthogonal to the precoding vector w , and w and $orth(w)$ can each be an $N_t \times 1$ vector, where N_t indicates the number of node transmit antennas.

In another example, the PRB pair can include at least two distributed CCE and at least one localized CCE. The channel estimator 726 can decode a downlink channel precoded with two precoding vector for transmit diversity applied to two UERS ports for the distributed CCEs. The two precoding vectors for transmit diversity can include precoding vectors $w1$, $w2$, $w3$, and/or $w4$, where each precoding vector is an $N_t \times 1$ vector, and N_t indicates the number of node transmit antennas.

In another configuration, the wireless device 720 can include a transceiver module 724 and a processing module 722. The wireless device can be

configured for enhanced physical downlink control channel (ePDCCH) validation semi-persistent scheduling (SPS) cell radio network temporary identifier (C-RNTI) masked scheduling. The transceiver module can be configured to receive downlink control information (DCI) carried by an ePDCCH having a PDSCH PRB
5 resource allocation (RA) that include at least one ePDCCH PRB. The processing module can be configured to exclude the at least one ePDCCH PRB from the PDSCH PRB resource allocation.

In an example, the at least one ePDCCH PRB can include an ePDCCH PRB for the wireless device, thus excluding the ePDCCH PRB for the wireless
10 device from the PDSCH PRB resource allocation. In another example, the at least one ePDCCH PRB can include all ePDCCH PRB in a subframe, thus excluding all ePDCCH PRB in a subframe from the PDSCH PRB resource allocation. A resource allocation type for the resource allocation can include RA type 0 resource block group (RBG) based scheduling, RA type 1 PRB based
15 scheduling using virtual resource blocks (VRBs), and RA type 2 contiguous PRB based scheduling using VRBs.

In another configuration, the wireless device 720 can also include a decoder 728 configured to decode the ePDCCH. The processing module 722 is further configured to check an indicator field for a '0' value in the ePDCCH for a
20 valid semi-persistent activation or release. The transceiver module can be further operable to receive PRB configuration information for ePDCCH via radio resource control (RRC) signaling.

In another configuration, the wireless device 720 can include a transceiver module 724 and a processing module 722. The wireless device can be
25 configured for downlink (DL) grant validation of a resource allocation (RA) including an enhanced physical downlink control channel (ePDCCH) physical resource block (PRB) carrying a downlink grant. The transceiver module can be configured to receive a semi-persistent scheduling (SPS) activate downlink grant masked with a SPS cell radio network temporary identifier (SPS-C-RNTI) for the
30 resource allocation including the ePDCCH. The processing module can be configured to validate a downlink control information (DCI) format of the downlink grant and determine that the downlink grant is received with a non-matching cyclic redundancy check (CRC) when the DCI format is not validated.

The processing module can be further configured to fail a validation of the DCI format for RA type 0, RA type 1, and RA type 2. In an example, the processing module can further comprise rate matching the ePDCCH PRB including the SPS activate downlink grant from a physical downlink shared channel (PDSCH) PRB to validate the DCI format. In another example, the processing module further comprises decoding the ePDCCH PRB as a physical downlink shared channel (PDSCH) PRB.

In another configuration, the wireless device 720 can include a transceiver module 724 and a processing module 722. The wireless device can be configured for uplink (UL) grant validation of a semi-persistent scheduling (SPS) physical downlink shared channel (PDSCH). The transceiver module can be configured to receive from a node a semi-persistent scheduling (SPS) activation downlink control information (DCI) and receive a physical downlink shared channel (PDSCH) without a corresponding enhanced physical downlink control channel (ePDCCH) in a subframe. Cyclic redundancy check (CRC) bits for an enhanced physical downlink control channel (ePDCCH) can be masked with a SPS cell radio network temporary identifier (C-RNTI). The processing module can be configured to validate an uplink grant in a physical resource block (PRB) for the PDSCH without the corresponding ePDCCH.

In an example, the processing module can be further configured to: be aware of no UL grant; and skip a blind decode for the UL grant in the PRB for the PDSCH without the corresponding ePDCCH when the wireless device does not detect an ePDCCH downlink (DL) assignment in the subframe. In another example, the processing module can be further configured to: Detect an ePDCCH downlink (DL) assignment in a common or user equipment (UE) search space for the wireless device in the subframe; and blind decode the UL grant including the PDSCH PRB without the corresponding ePDCCH.

FIG. 16 provides an example illustration of the wireless device, such as an user equipment (UE), a mobile station (MS), a mobile wireless device, a mobile communication device, a tablet, a handset, or other type of wireless device. The wireless device can include one or more antennas configured to communicate with a node, macro node, low power node (LPN), or, transmission station, such as a base station (BS), an evolved Node B (eNB), a baseband unit (BBU), a remote

radio head (RRH), a remote radio equipment (RRE), a relay station (RS), a radio equipment (RE), or other type of wireless wide area network (WWAN) access point. The wireless device can be configured to communicate using at least one wireless communication standard including 3GPP LTE, WiMAX, High Speed
5 Packet Access (HSPA), Bluetooth, and WiFi. The wireless device can communicate using separate antennas for each wireless communication standard or shared antennas for multiple wireless communication standards. The wireless device can communicate in a wireless local area network (WLAN), a wireless personal area network (WPAN), and/or a WWAN.

10 FIG. 16 also provides an illustration of a microphone and one or more speakers that can be used for audio input and output from the wireless device. The display screen may be a liquid crystal display (LCD) screen, or other type of display screen such as an organic light emitting diode (OLED) display. The display screen can be configured as a touch screen. The touch screen may use
15 capacitive, resistive, or another type of touch screen technology. An application processor and a graphics processor can be coupled to internal memory to provide processing and display capabilities. A non-volatile memory port can also be used to provide data input/output options to a user. The non-volatile memory port may also be used to expand the memory capabilities of the wireless device. A
20 keyboard may be integrated with the wireless device or wirelessly connected to the wireless device to provide additional user input. A virtual keyboard may also be provided using the touch screen.

Various techniques, or certain aspects or portions thereof, may take the form of program code (i.e., instructions) embodied in tangible media, such as
25 floppy diskettes, CD-ROMs, hard drives, non-transitory computer readable storage medium, or any other machine-readable storage medium wherein, when the program code is loaded into and executed by a machine, such as a computer, the machine becomes an apparatus for practicing the various techniques. A non-transitory computer readable storage medium can be a computer readable
30 storage medium that does not include signal. In the case of program code execution on programmable computers, the computing device may include a processor, a storage medium readable by the processor (including volatile and non-volatile memory and/or storage elements), at least one input device, and at

least one output device. The volatile and non-volatile memory and/or storage elements may be a RAM, EPROM, flash drive, optical drive, magnetic hard drive, solid state drive, or other medium for storing electronic data. The node and wireless device may also include a transceiver module, a counter module, a processing module, and/or a clock module or timer module. One or more programs that may implement or utilize the various techniques described herein may use an application programming interface (API), reusable controls, and the like. Such programs may be implemented in a high level procedural or object oriented programming language to communicate with a computer system.

5
10 However, the program(s) may be implemented in assembly or machine language, if desired. In any case, the language may be a compiled or interpreted language, and combined with hardware implementations.

It should be understood that many of the functional units described in this specification have been labeled as modules, in order to more particularly emphasize their implementation independence. For example, a module may be implemented as a hardware circuit comprising custom VLSI circuits or gate arrays, off-the-shelf semiconductors such as logic chips, transistors, or other discrete components. A module may also be implemented in programmable hardware devices such as field programmable gate arrays, programmable array logic, programmable logic devices or the like.

15
20 Modules may also be implemented in software for execution by various types of processors. An identified module of executable code may, for instance, comprise one or more physical or logical blocks of computer instructions, which may, for instance, be organized as an object, procedure, or function. Nevertheless, the executables of an identified module need not be physically located together, but may comprise disparate instructions stored in different locations which, when joined logically together, comprise the module and achieve the stated purpose for the module.

25
30 Indeed, a module of executable code may be a single instruction, or many instructions, and may even be distributed over several different code segments, among different programs, and across several memory devices. Similarly, operational data may be identified and illustrated herein within modules, and may be embodied in any suitable form and organized within any suitable type of data

structure. The operational data may be collected as a single data set, or may be distributed over different locations including over different storage devices, and may exist, at least partially, merely as electronic signals on a system or network. The modules may be passive or active, including agents operable to perform
5 desired functions.

Reference throughout this specification to "an example" means that a particular feature, structure, or characteristic described in connection with the example is included in at least one embodiment of the present invention. Thus, appearances of the phrases "in an example" in various places throughout this
10 specification are not necessarily all referring to the same embodiment.

As used herein, a plurality of items, structural elements, compositional elements, and/or materials may be presented in a common list for convenience. However, these lists should be construed as though each member of the list is individually identified as a separate and unique member. Thus, no individual
15 member of such list should be construed as a de facto equivalent of any other member of the same list solely based on their presentation in a common group without indications to the contrary. In addition, various embodiments and example of the present invention may be referred to herein along with alternatives for the various components thereof. It is understood that such embodiments, examples,
20 and alternatives are not to be construed as defacto equivalents of one another, but are to be considered as separate and autonomous representations of the present invention.

Furthermore, the described features, structures, or characteristics may be combined in any suitable manner in one or more embodiments. In the following
25 description, numerous specific details are provided, such as examples of layouts, distances, network examples, etc., to provide a thorough understanding of embodiments of the invention. One skilled in the relevant art will recognize, however, that the invention can be practiced without one or more of the specific details, or with other methods, components, layouts, etc. In other instances, well-
30 known structures, materials, or operations are not shown or described in detail to avoid obscuring aspects of the invention.

While the forgoing examples are illustrative of the principles of the present invention in one or more particular applications, it will be apparent to those of

ordinary skill in the art that numerous modifications in form, usage and details of implementation can be made without the exercise of inventive faculty, and without departing from the principles and concepts of the invention. Accordingly, it is not intended that the invention be limited, except as by the claims set forth below.

5

CLAIMS

What is claimed is:

1. A method for downlink (DL) grant validation, comprising:
receiving from a node a downlink grant masked with a cell radio network
5 temporary identifier (C-RNTI) for a resource allocation (RA) including an
enhanced physical downlink control channel (ePDCCH) physical resource block
(PRB) carrying the downlink grant;
validating a downlink control information (DCI) format of the downlink grant;
and
10 determining that the downlink grant is received with a non-matching cyclic
redundancy check (CRC) when the DCI format is not validated.
2. The method of claim 1, wherein validating the DCI format fails when
RA type 0, RA type 1, or RA type 2 has a resource block group (RBG) size or
contiguous PRB size greater than one PRB.
- 15 3. The method of claim 1, wherein validating the DCI format validates
the DCI format when RA type 0 or RA type 1 has a resource block group (RBG)
size equal to one PRB.
4. The method of claim 3, further comprising:
decoding ePDCCH user equipment-specific reference signal (UERS) and
20 the PDSCH UERS using a same precoding matrix where a precoding vector for
ePDCCH UERS is orthogonal to a precoding vector for another ePDCCH UERS in
a same PRB.
5. The method of claim 4, wherein the same precoding vector is
applied for both ePDCCH and a first layer of PDSCH in the same PRB bundling
25 window when the DCI allocates PRBs excluded from PDSCH decoding and the
node avoided allocating the excluded PRBs in RA signaling.
6. The method of claim 4, further comprising:
demodulating one ePDCCH using one UERS antenna port X, wherein the
one ePDCCH is localized; and
30 demodulating another ePDCCH using two UERS antenna ports X and Y,
wherein the another ePDCCH is distributed.
7. The method of claim 6, wherein the UERS antenna ports X and Y
belong to a same code division multiplexing (CDM) group.

8. The method of claim 1, wherein the downlink grant is a semi-persistent scheduling (SPS) activate downlink grant, and the SPS activate downlink grant is masked with an SPS-C-RNTI.

9. The method of claim 8, wherein validating the DCI format fails for RA type 0, RA type 1, and RA type 2.

10. The method of claim 8, wherein validating the DCI format validates the DCI format, and further comprises:

physical downlink shared channel (PDSCH) rate matching to the PRBs including the SPS activate downlink grant.

11. The method of claim 10, further comprising:
decoding the ePDCCH PRB as a PDSCH PRB.

12. The method of claim 10, further comprising:
rate matching the ePDCCH PRB including the SPS activate downlink grant from PDSCH PRBs.

13. The method of claim 1, wherein validating the DCI format fails when an uplink grant is included in a semi-persistent scheduling (SPS) physical downlink shared channel (PDSCH) PRB of the resource allocation.

14. At least one non-transitory machine readable storage medium comprising a plurality of instructions adapted to be executed to implement the method of claim 1.

15. A wireless device configured for downlink (DL) grant validation of a resource allocation (RA) including an enhanced physical downlink control channel (ePDCCH) physical resource block (PRB) carrying a downlink grant, comprising:

a transceiver module to receive a semi-persistent scheduling (SPS) activate downlink grant masked with a SPS cell radio network temporary identifier (SPS-C-RNTI) for the resource allocation including the ePDCCH; and

a processing module to validate a downlink control information (DCI) format of the downlink grant and determine that the downlink grant is received with a non-matching cyclic redundancy check (CRC) when the DCI format is not validated.

16. The wireless device of claim 15, wherein the processing module is further configured to fail a validation of the DCI format fails for RA type 0, RA type 1, and RA type 2.

17. The wireless device of claim 15, wherein the processing module further comprises rate matching the ePDCCH PRB including the SPS activate downlink grant from a physical downlink shared channel (PDSCH) PRB to validate the DCI format.

5 18. The wireless device of claim 15, wherein the processing module further comprises decoding the ePDCCH PRB as a physical downlink shared channel (PDSCH) PRB.

10 19. The wireless device of claim 15, wherein the wireless device is selected from the group consisting of a user equipment (UE) and a mobile station (MS), and the wireless device includes at least one of an antenna, a touch sensitive display screen, a speaker, a microphone, a graphics processor, an application processor, internal memory, a non-volatile memory port, and combinations thereof.

15 20. At least one non-transitory machine readable storage medium comprising a plurality of instructions adapted to be executed to implement a method to receive a physical downlink shared channel (PDSCH) physical resource block (PRB) resource allocation (RA), comprising:

20 receiving from a node a PDSCH PRB resource allocation, wherein an enhanced physical downlink control channel (ePDCCH) is in a resource block group (RBG) or contiguous PRBs associated with the PDSCH PRB resource allocation; and

excluding the at least one ePDCCH PRB from the PDSCH PRB resource allocation so the at least one ePDCCH PRB is not part of the PDSCH PRB resource allocation.

25 21. The at least one non-transitory machine readable storage medium of claim 20, wherein the resource allocation type for the resource allocation is selected from the grouping consisting of RA type 0 resource block group (RBG) based scheduling, RA type 1 PRB based scheduling using virtual resource blocks (VRBs), and RA type 2 contiguous PRB based scheduling using VRBs.

30 22. The at least one non-transitory machine readable storage medium of claim 20, wherein the at least one ePDCCH PRB includes at least one of a localized ePDCCH and a distributed ePDCCH.

23. The at least one non-transitory machine readable storage medium of claim 20, wherein the at least one ePDCCH PRB includes a PRB pair, wherein the PRB pair is two continuous PRBs using the same subcarriers in a subframe.

24. A method for uplink (UL) grant validation, comprising:

5 receiving, from a node at a wireless device, a semi-persistent scheduling (SPS) activation downlink control information (DCI), wherein cyclic redundancy check (CRC) bits for an enhanced physical downlink control channel (ePDCCH) is masked with a SPS cell radio network temporary identifier (C-RNTI);

10 receiving from a node a physical downlink shared channel (PDSCH) without a corresponding enhanced physical downlink control channel (ePDCCH) in a subframe; and

validating an uplink grant in a physical resource block (PRB) for the PDSCH without the corresponding ePDCCH.

15 25. The method of claim 24, wherein validating the uplink grant further comprises:

being aware of no UL grant; and

skipping a blind decode for the UL grant in the PRB for the PDSCH without the corresponding ePDCCH when the wireless device does not detect an ePDCCH downlink (DL) assignment in the subframe.

20 26. The method of claim 24, wherein validating the uplink grant further comprises:

detecting an ePDCCH downlink (DL) assignment in a common or user equipment (UE) search space for the wireless device in the subframe; and

25 blind decoding of the UL grant including the PDSCH PRB without the corresponding ePDCCH.

27. At least one non-transitory machine readable storage medium comprising a plurality of instructions adapted to be executed to implement the method of claim 24.

1/16

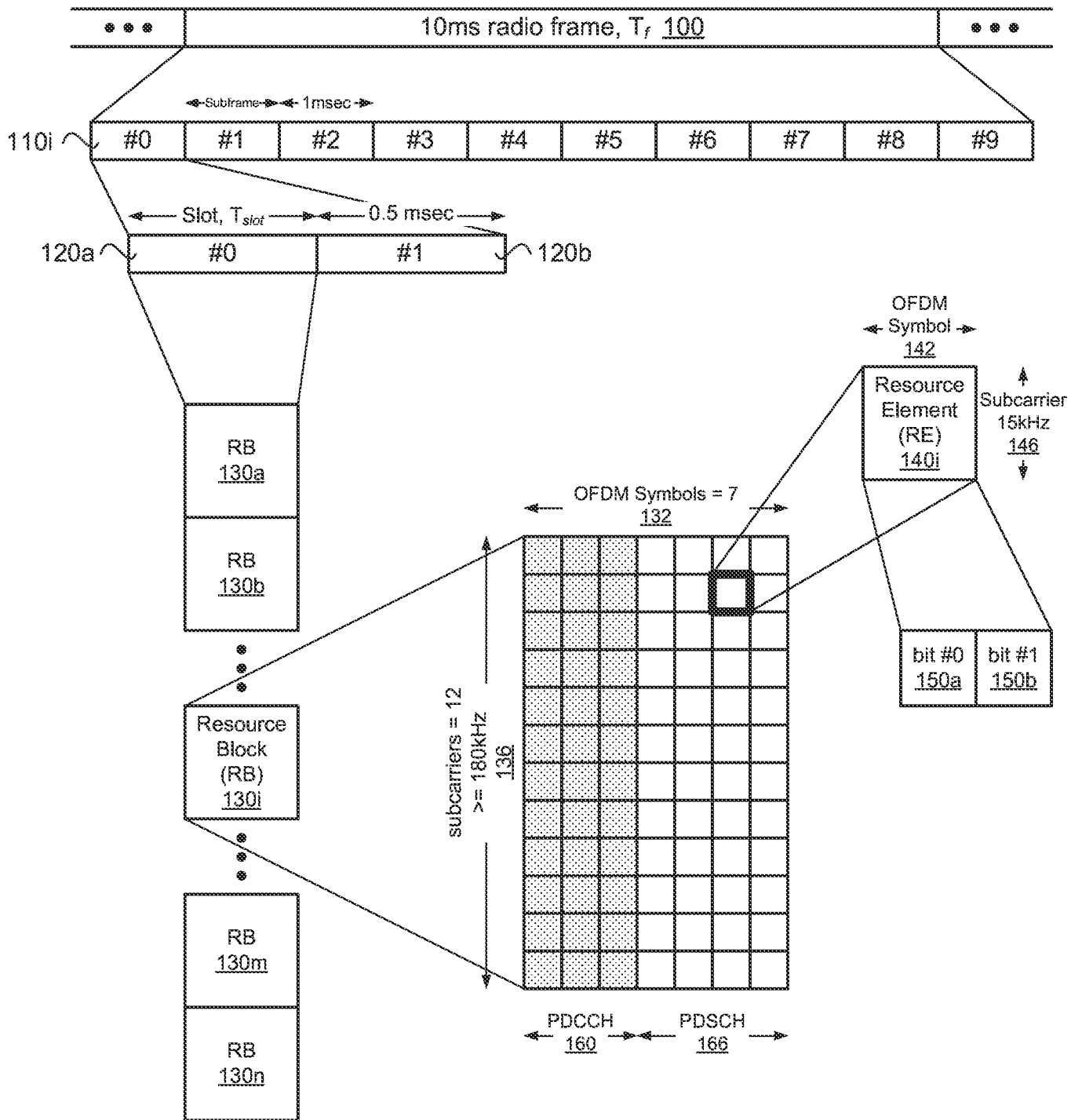

FIG. 1

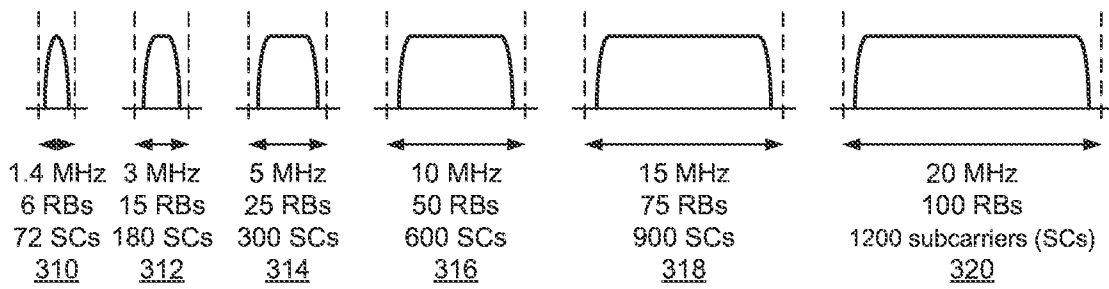

FIG. 2

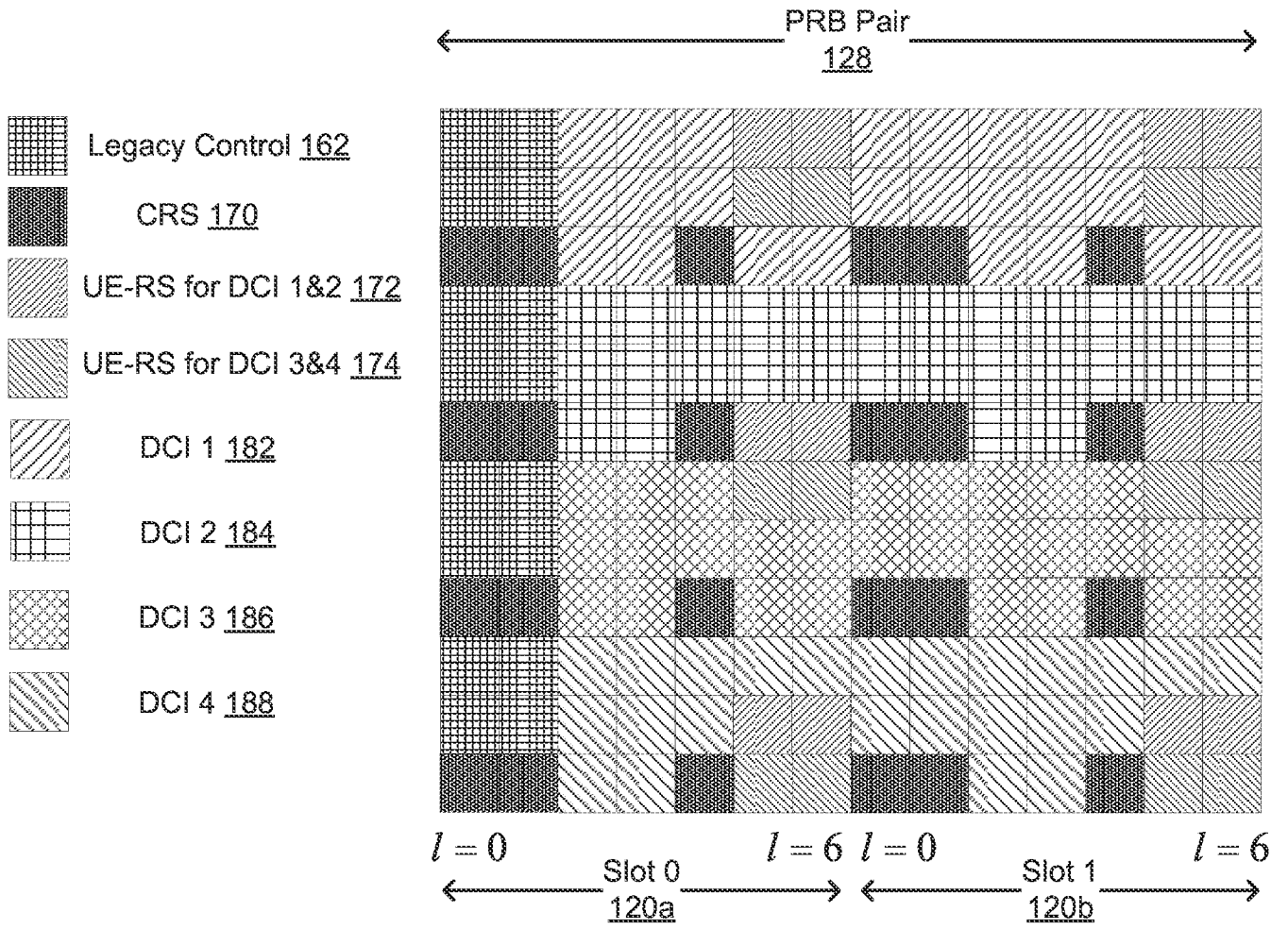

FIG. 3

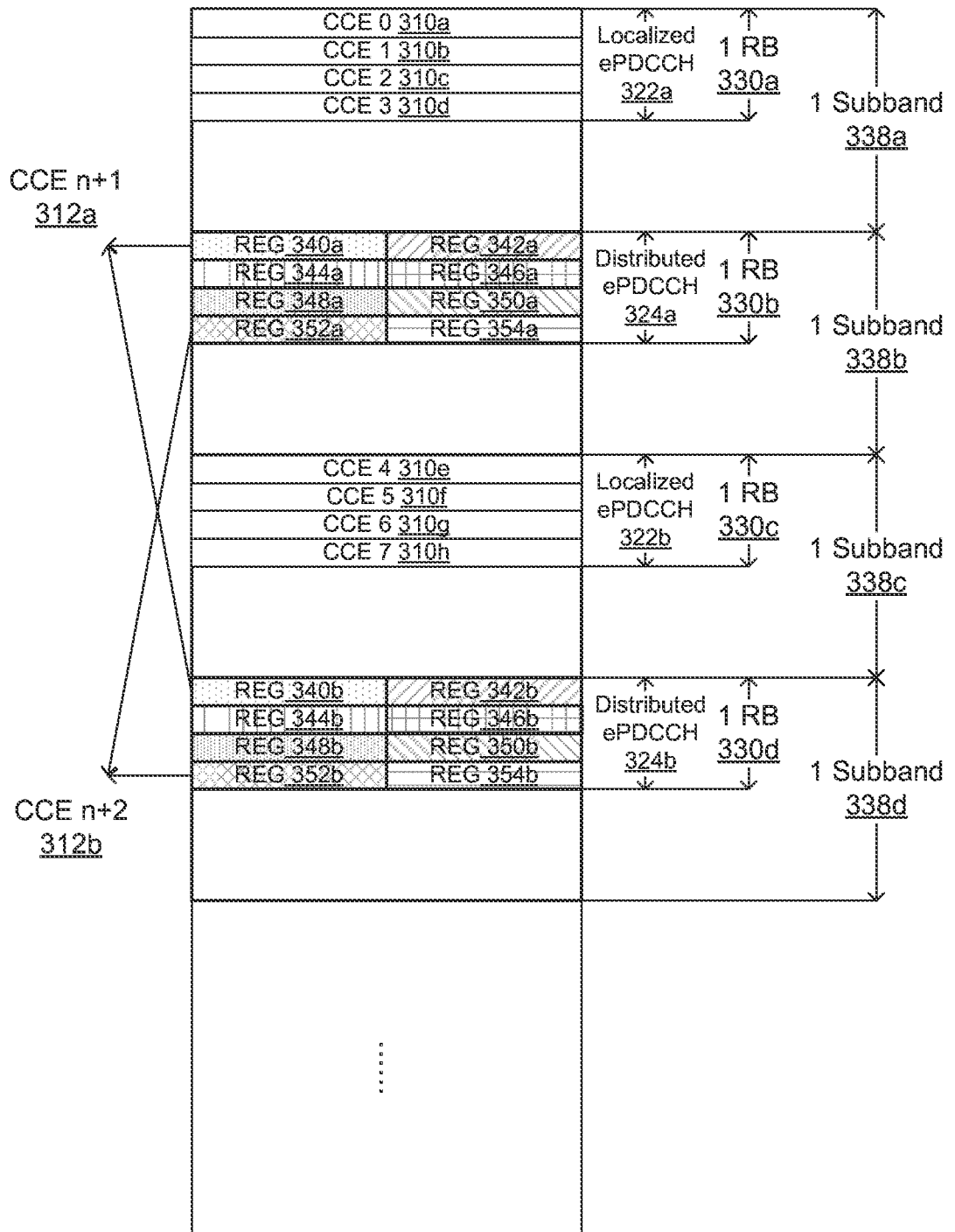

FIG. 4

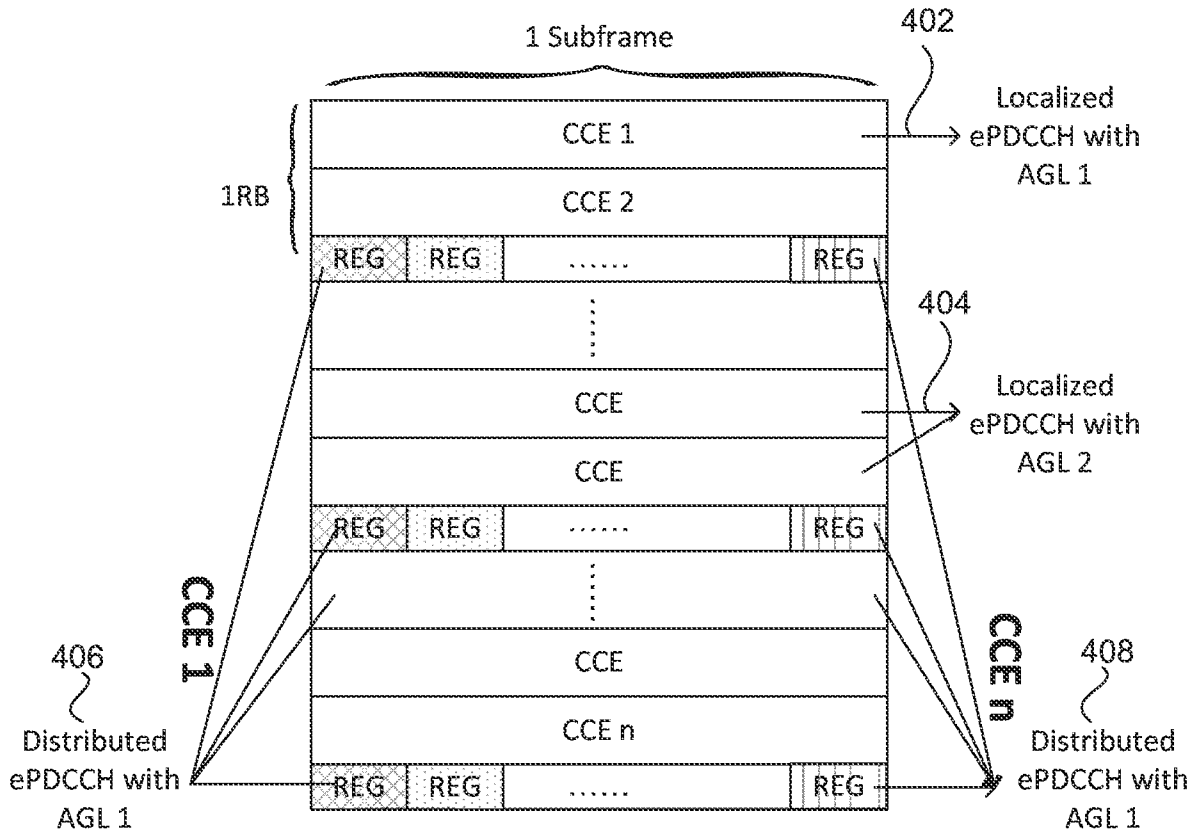

FIG. 5

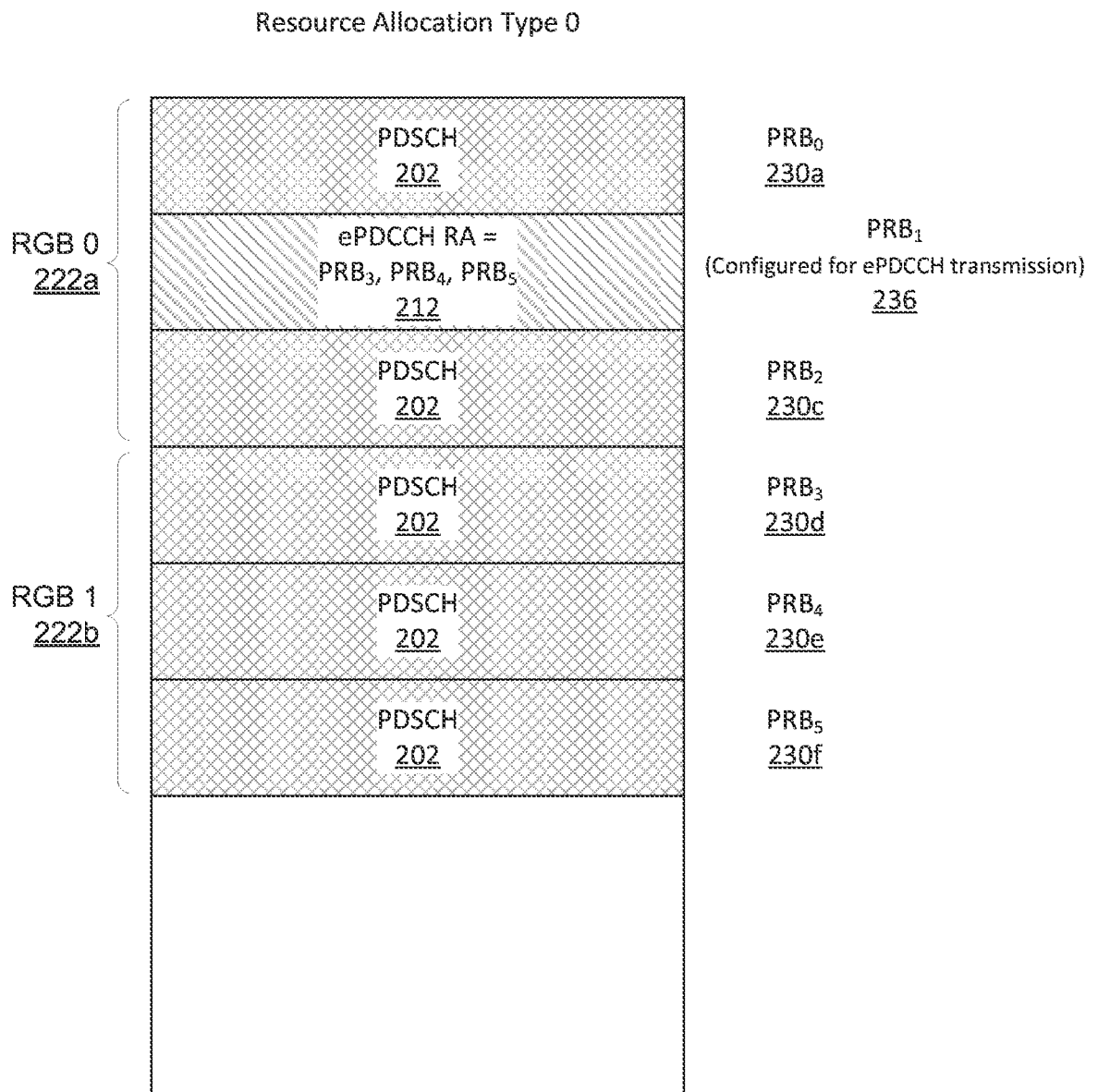

FIG. 6

Resource Allocation Type 1

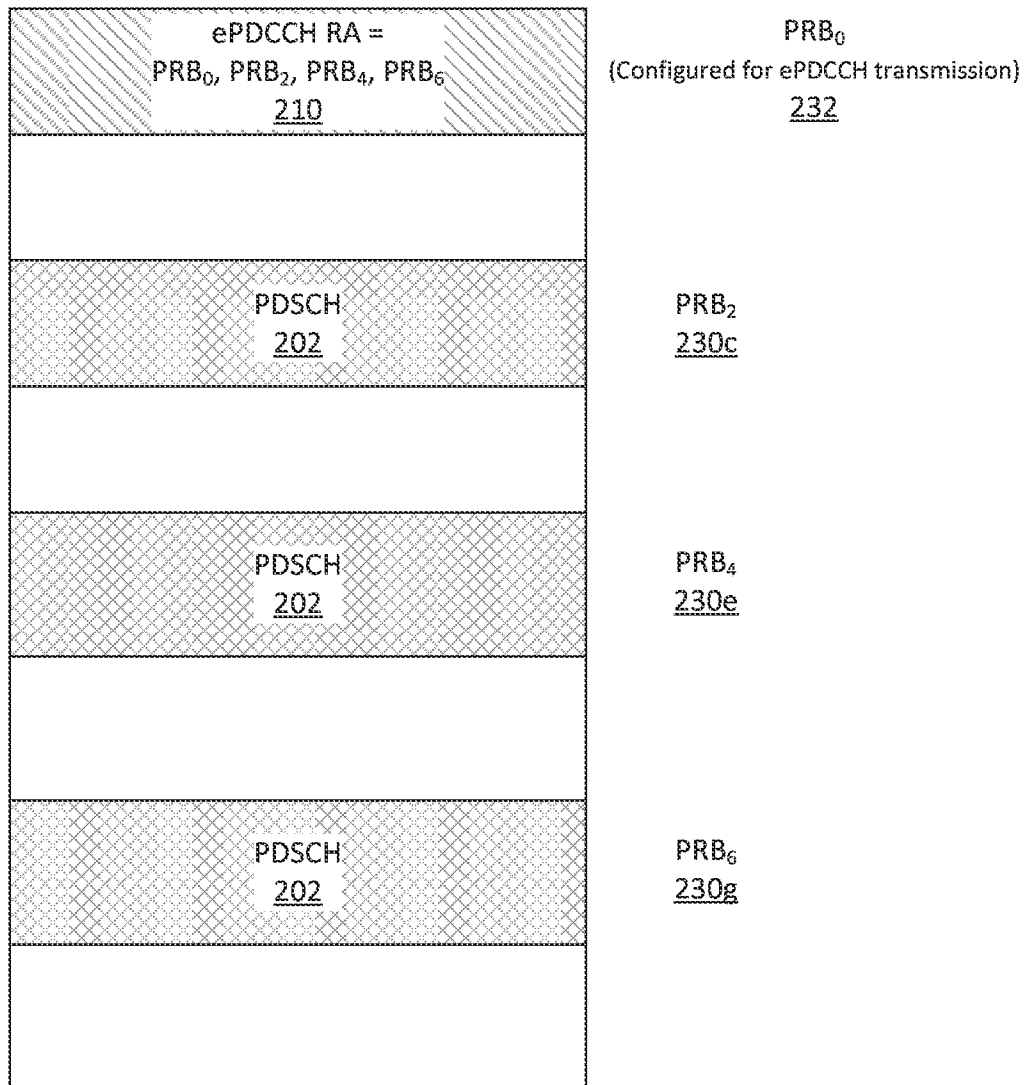

FIG. 7

8/16

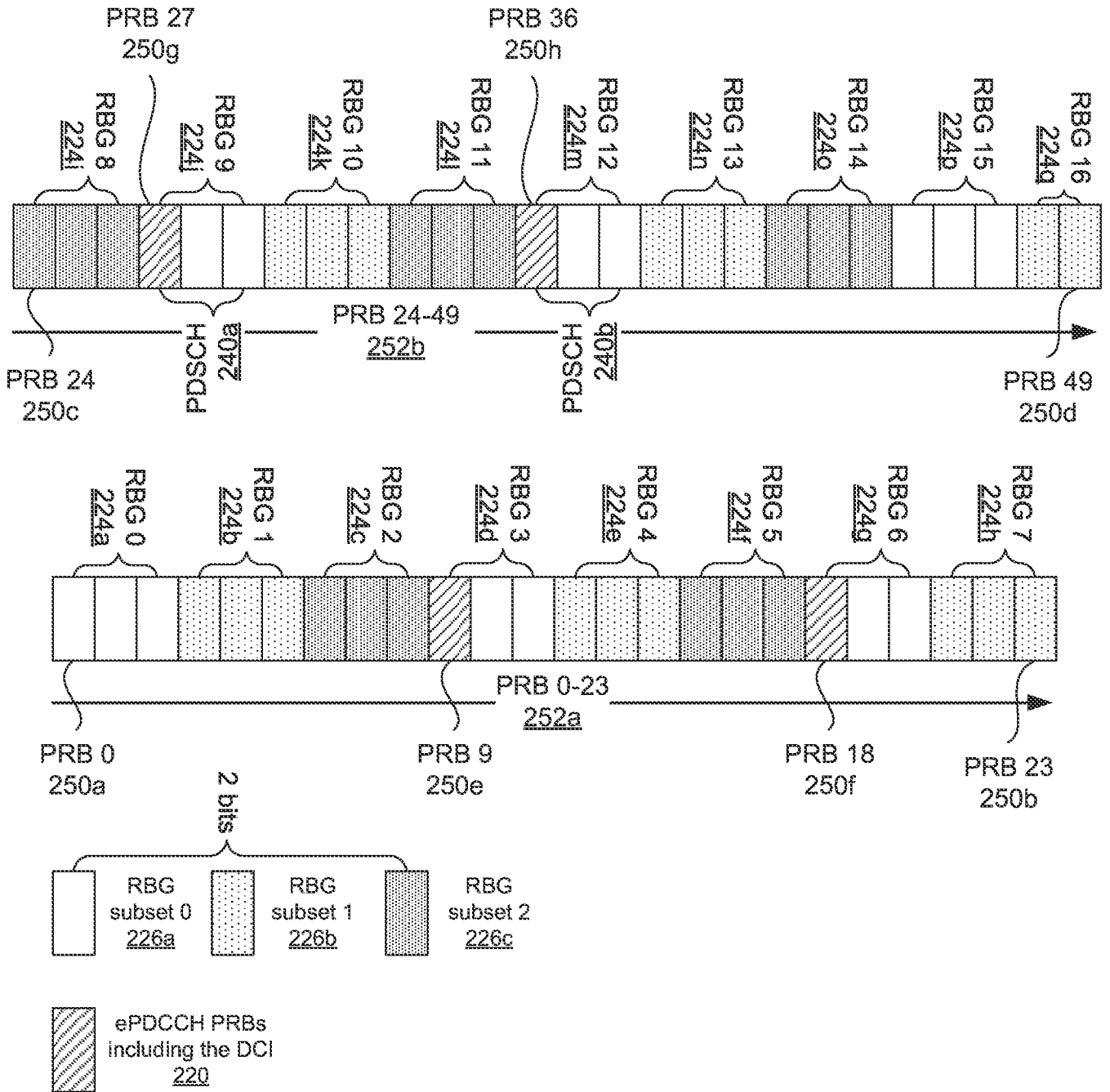

FIG. 8

9/16

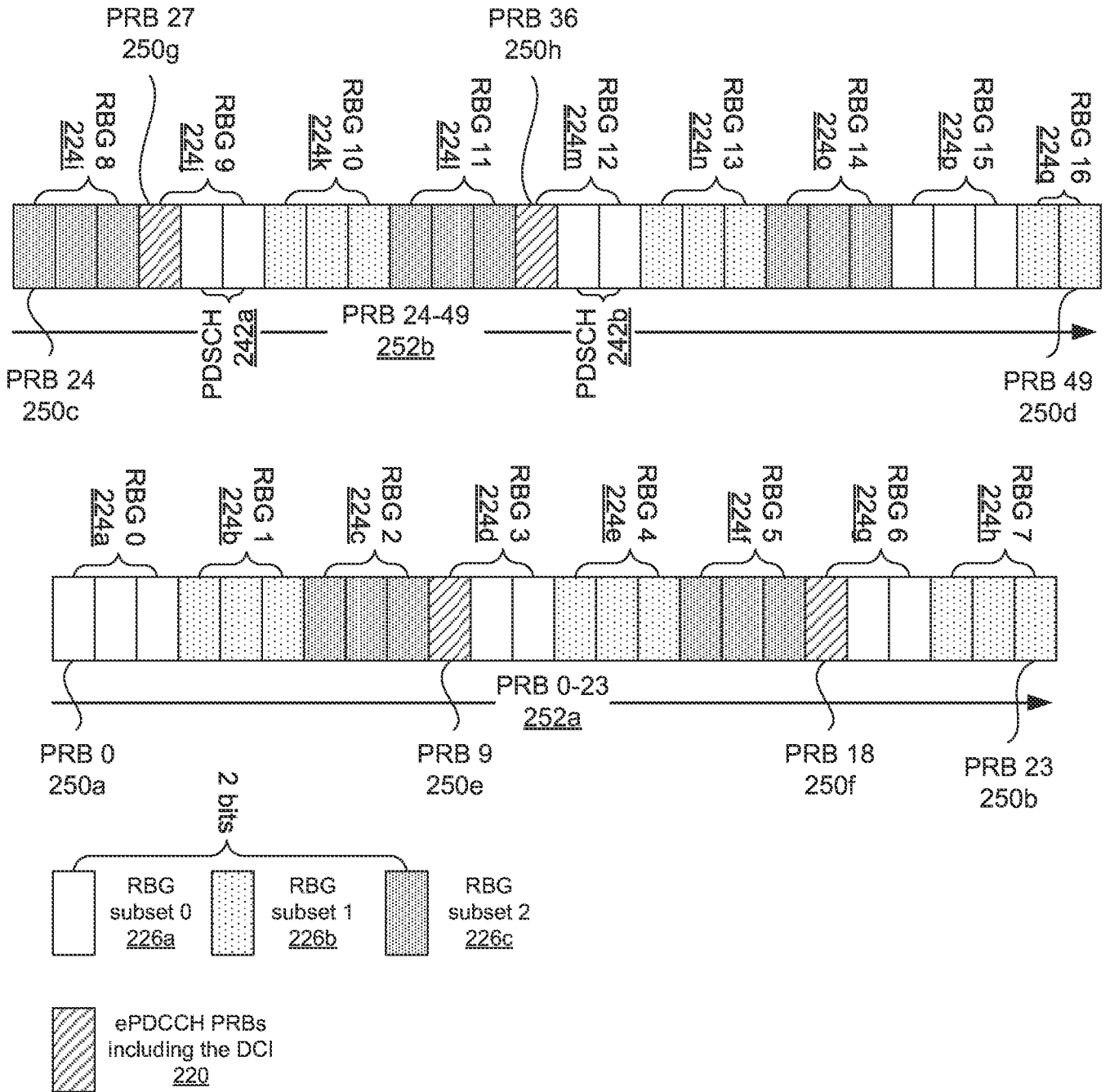

FIG. 9

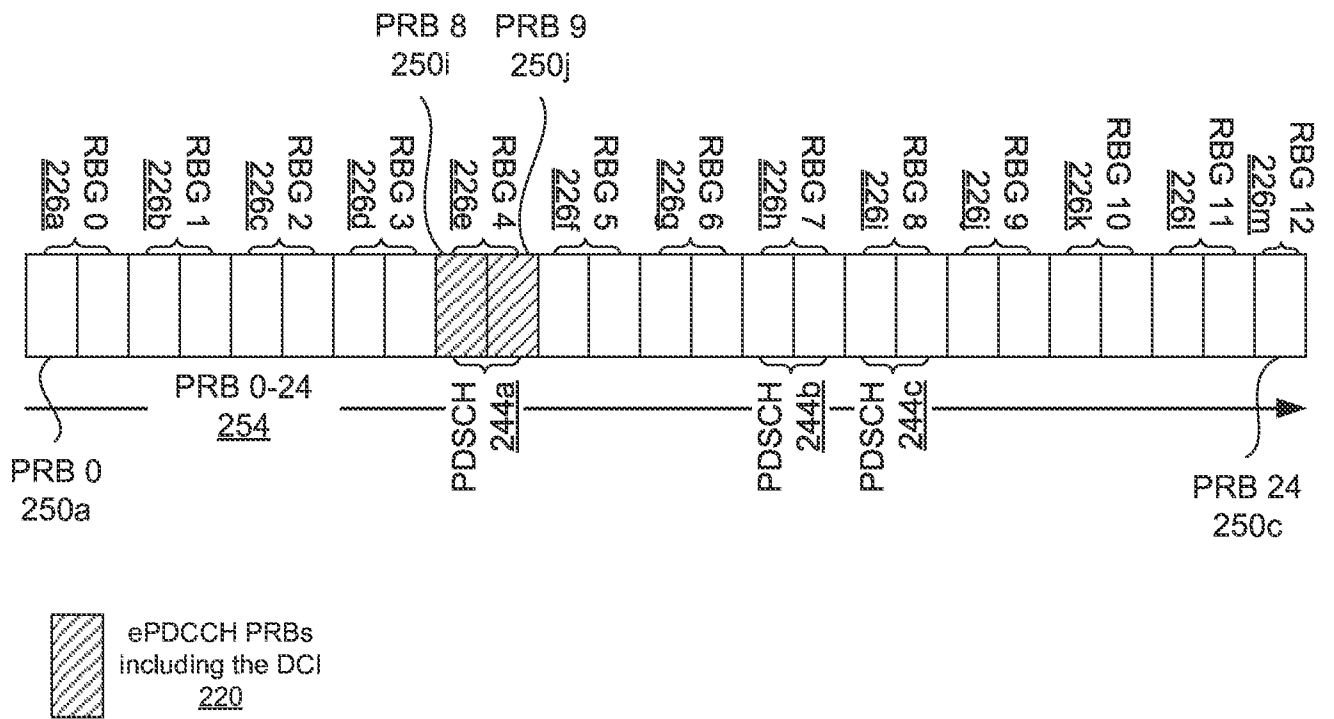

FIG. 10

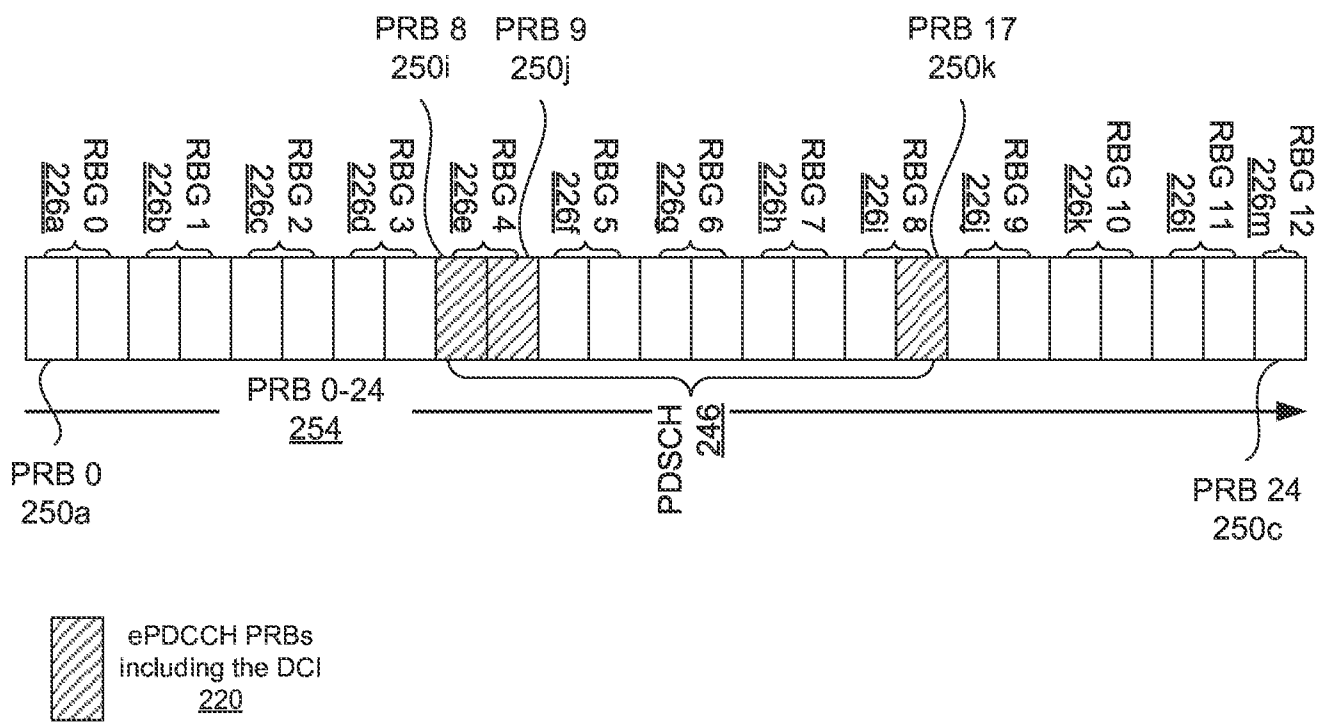

FIG. 11

12/16

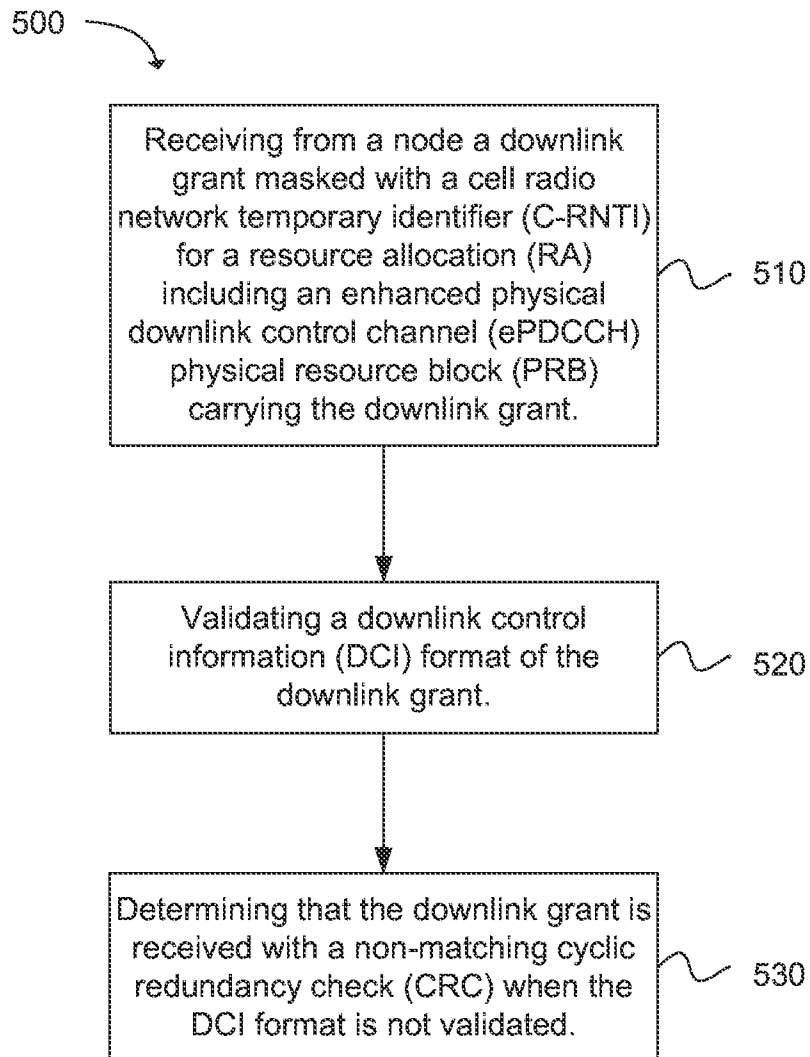

FIG. 12

13/16

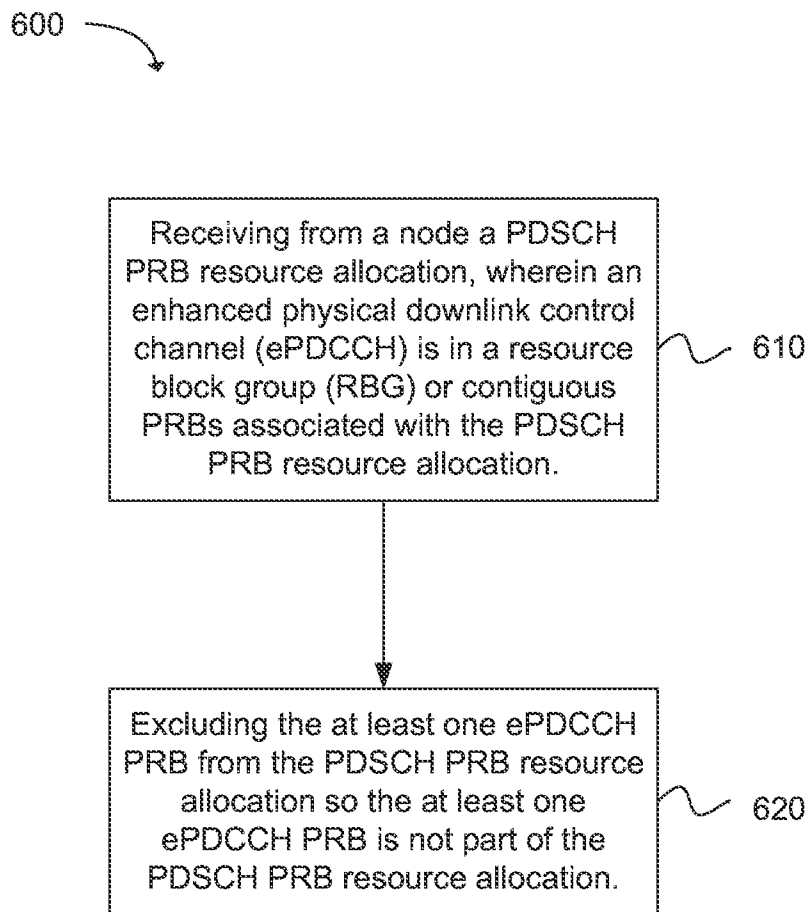

FIG. 13

14/16

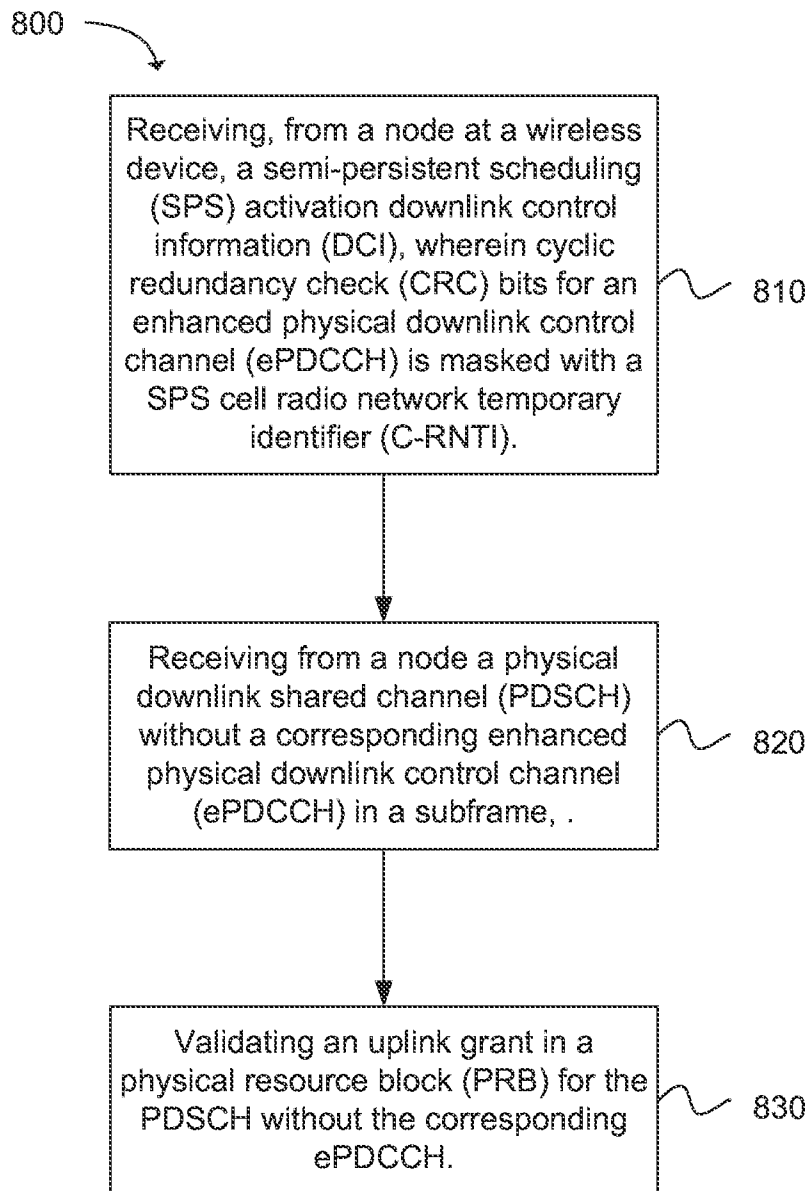

FIG. 14

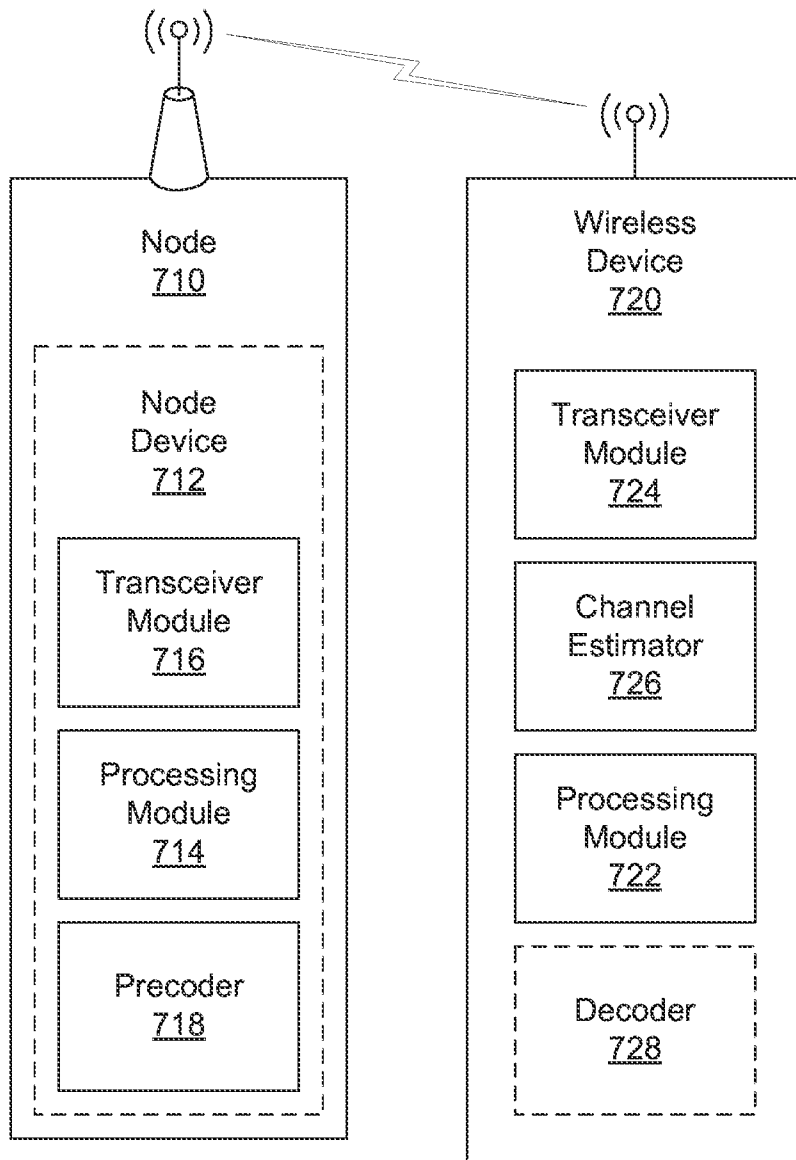

FIG. 15

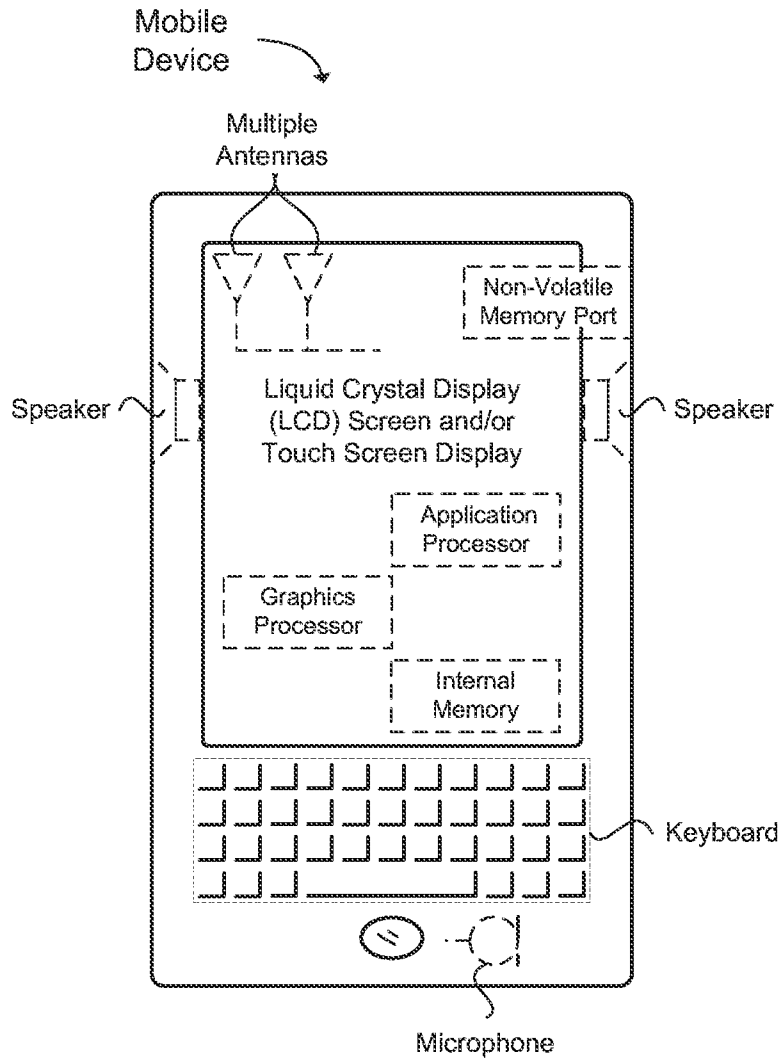

FIG. 16

INTERNATIONAL SEARCH REPORT

International application No.
PCT/US2013/031796**A. CLASSIFICATION OF SUBJECT MATTER****H04J 11/00(2006.01)i, H04B 7/26(2006.01)i**

According to International Patent Classification (IPC) or to both national classification and IPC

B. FIELDS SEARCHED

Minimum documentation searched (classification system followed by classification symbols)

H04J 11/00; H04W 72/12; H04B 7/26

Documentation searched other than minimum documentation to the extent that such documents are included in the fields searched

Korean utility models and applications for utility models

Japanese utility models and applications for utility models

Electronic data base consulted during the international search (name of data base and, where practicable, search terms used)

eKOMPASS(KIPO internal) & keywords: downlink grant validation, C-RNTI, RA type, CRC

C. DOCUMENTS CONSIDERED TO BE RELEVANT

Category*	Citation of document, with indication, where appropriate, of the relevant passages	Relevant to claim No.
X	PANASONIC, `Search space design for enhanced PDCCH`, R1-120236, 3GPP TSG RAN WG1 Meeting #68, Dresden, Germany, 6-10 February 2012 See pages 1-4.	1-3, 14
Y		4-13, 15-19, 22
Y	ERICSSON et al., `On reference signal design for enhanced control channels`, R1-120076, 3GPP TSG RAN WG1 #68, Dresden, Germany, 6-10 February 2012 See pages 1-4.	4-7
Y	US 2011-0299483 A1 (CHIN-HSIANG WU) 08 December 2011 See paragraphs [0029]-[0059]; and figures 1-5.	8-13, 15-19, 24-27
X	PANASONIC, `Multiplexing between ePDCCH and PDSCH`, R1-120235, 3GPP TSG RAN WG1 Meeting #68, Dresden, Germany, 6-10 February 2012 See pages 1-3.	20, 21, 23
Y		22, 24-27
A	LG ELECTRONICS, `Multiplexing PDSCH and E-PDCCH within a PRB pair`, R1-120449, 3GPP TSG RAN WG1 Meeting #68, Dresden, Germany, 6-10 February 2012 See pages 1-3.	1-27

 Further documents are listed in the continuation of Box C. See patent family annex.

* Special categories of cited documents:

"A" document defining the general state of the art which is not considered to be of particular relevance

"E" earlier application or patent but published on or after the international filing date

"L" document which may throw doubts on priority claim(s) or which is cited to establish the publication date of citation or other special reason (as specified)

"O" document referring to an oral disclosure, use, exhibition or other means

"P" document published prior to the international filing date but later than the priority date claimed

"T" later document published after the international filing date or priority date and not in conflict with the application but cited to understand the principle or theory underlying the invention

"X" document of particular relevance; the claimed invention cannot be considered novel or cannot be considered to involve an inventive step when the document is taken alone

"Y" document of particular relevance; the claimed invention cannot be considered to involve an inventive step when the document is combined with one or more other such documents, such combination being obvious to a person skilled in the art

"&" document member of the same patent family

Date of the actual completion of the international search

26 June 2013 (26.06.2013)

Date of mailing of the international search report

28 June 2013 (28.06.2013)

Name and mailing address of the ISA/KR

Korean Intellectual Property Office
189 Cheongsa-ro, Seo-gu, Daejeon Metropolitan City,
302-701, Republic of Korea

Facsimile No. 82-42-472-7140

Authorized officer

KIM, Do Weon

Telephone No. 82-42-481-5560



INTERNATIONAL SEARCH REPORT

Information on patent family members

International application No.

PCT/US2013/031796

Patent document cited in search report	Publication date	Patent family member(s)	Publication date
US 2011-0299483 A1	08.12.2011	CN 102271334 A EP 2393332 A2 EP 2393332 A3 EP 2512197 A1 JP 2011-254480 A KR 10-2011-0132999 A TW 201146064 A	07.12.2011 07.12.2011 22.02.2012 17.10.2012 15.12.2011 09.12.2011 16.12.2011