



US00D569742S

(12) **United States Design Patent**
Scheufele

(10) **Patent No.:** **US D569,742 S**

(45) **Date of Patent:** **** May 27, 2008**

(54) **WATCH CHRONOGRAPH**

(75) Inventor: **Karl-Friedrich Scheufele**, Prangins
(CH)

(73) Assignee: **Chopard International SA**, Prangins
(CH)

(**) Term: **14 Years**

(21) Appl. No.: **29/295,719**

(22) Filed: **Oct. 4, 2007**

(30) **Foreign Application Priority Data**

Apr. 11, 2007 (WO) DM/069 319

(51) **LOC (8) CL.** **10-02**

(52) **U.S. CL.** **D10/39**

(58) **Field of Classification Search** D10/30-39,
D10/122-132; 368/276, 277, 281, 282, 285,
368/80, 288-290, 223, 228, 232, 21, 28,
368/306, 308, 320, 321

See application file for complete search history.

(56) **References Cited**

U.S. PATENT DOCUMENTS

2,361,563	A *	10/1944	Pellaton	368/80
D195,421	S *	6/1963	Huguenin	D10/39
3,740,944	A *	6/1973	Chopard	368/281
3,901,023	A *	8/1975	Uebelhardt	368/281
D317,128	S *	5/1991	Benson	D10/32

5,220,541	A *	6/1993	Vuilleumier	368/88
D352,470	S *	11/1994	Besson	D10/39
D391,501	S *	3/1998	Giardiello	D10/39
5,724,317	A *	3/1998	Kubota et al.	368/11
D405,375	S *	2/1999	Chodat	D10/39
D447,427	S *	9/2001	Finazzi	D10/39
D517,432	S *	3/2006	Laucella	D10/39
D538,182	S *	3/2007	Lalo	D10/32
D538,184	S *	3/2007	Scheufele	D10/39
D547,212	S *	7/2007	Dias	D10/39

* cited by examiner

Primary Examiner—Lucy Lieberman

(74) *Attorney, Agent, or Firm*—McGlew and Tuttle P.C.

(57) **CLAIM**

The ornamental design for a watch chronograph, as shown and described.

DESCRIPTION

FIG. 1 is a right side view of my new watch chronograph design;

FIG. 2 is a front view thereof;

FIG. 3 is a left side view thereof;

FIG. 4 is a bottom view thereof;

FIG. 5 is a rear elevation thereof;

FIG. 6 is a top plan view thereof; and,

FIG. 7 is a perspective view thereof.

1 Claim, 3 Drawing Sheets

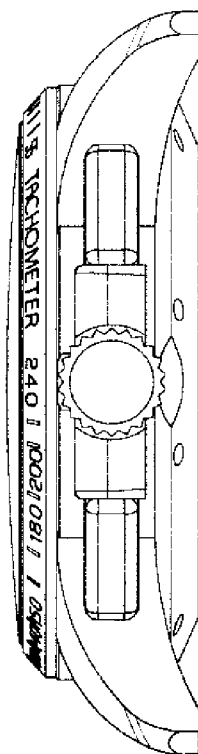

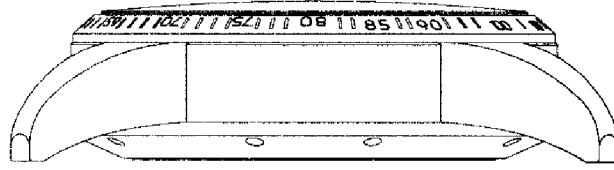

Fig. 3

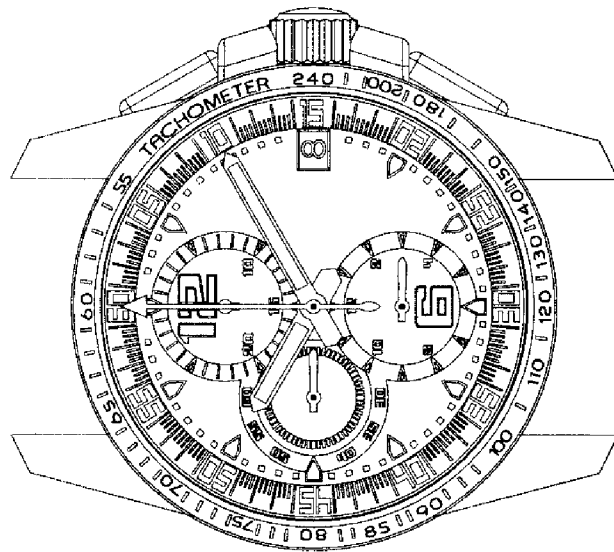

Fig. 2

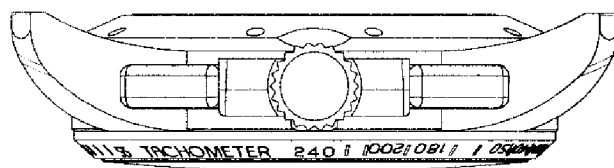

Fig. 1

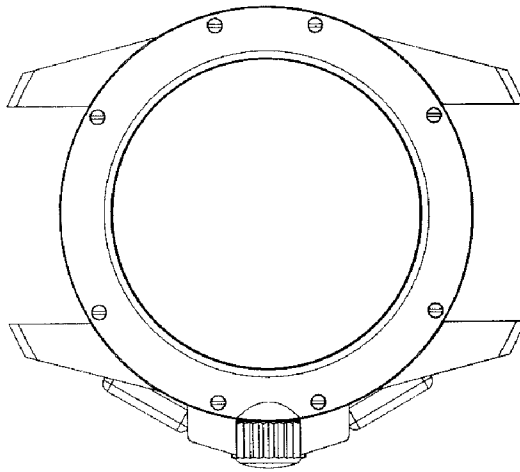

Fig. 5

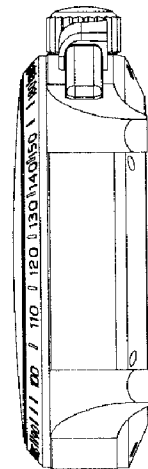

Fig. 4

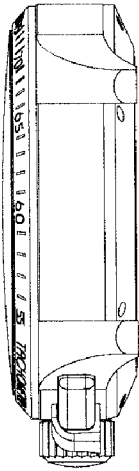

Fig. 6



Fig. 7