



US00D976255S

(12) **United States Design Patent**
Chung

(10) **Patent No.:** **US D976,255 S**

(45) **Date of Patent:** **** *Jan. 24, 2023**

(54) **SMART WATCH**

(71) Applicant: **Samsung Electronics Co., Ltd.**,
Suwon-si (KR)

(72) Inventor: **Insik Chung**, Suwon-si (KR)

(73) Assignee: **Samsung Electronics Co., Ltd.**,
Suwon-si (KR)

(*) Notice: This patent is subject to a terminal disclaimer.

(**) Term: **15 Years**

(21) Appl. No.: **29/753,608**

(22) Filed: **Oct. 1, 2020**

(30) **Foreign Application Priority Data**

Jun. 1, 2020 (KR) 30-2020-0024165

(51) **LOC (14) Cl.** **14-02**

(52) **U.S. Cl.**
USPC **D14/344**

(58) **Field of Classification Search**
USPC ... D14/138 R, 144, 341, 344, 346, 388, 389,
D14/390, 496; D10/30-32, 38, 70,
(Continued)

(56) **References Cited**

U.S. PATENT DOCUMENTS

D377,613 S * 1/1997 Consolo D10/38
D580,792 S * 11/2008 Sugiura D10/32
(Continued)

FOREIGN PATENT DOCUMENTS

CN 2014304974278 5/2015
CN 2016303638813 1/2017
(Continued)

OTHER PUBLICATIONS

Samsung Galaxy Watch is here:, www.androidauthority.com, Aug. 9, 2018. <https://www.androidauthority.com/samsung-galaxy-watch-2-893420/> (Year: 2018).*

(Continued)

Primary Examiner — Llorelys Martinez
Assistant Examiner — Kwabena A. Ankobiah
(74) *Attorney, Agent, or Firm* — NSIP Law

(57) **CLAIM**

I claim the ornamental design for a smart watch, as shown and described.

DESCRIPTION

FIG. 1 is a front perspective view of a smart watch showing my new design;
FIG. 2 is a front view thereof;
FIG. 3 is a rear view thereof;
FIG. 4 is a left-side view thereof;
FIG. 5 is a right-side view thereof;
FIG. 6 is a top view thereof;
FIG. 7 is a bottom view thereof;
FIG. 8 is a rear perspective view thereof;
FIG. 9 is an enlarged view of the encircled portion in FIG. 1;
FIG. 10 is an enlarged view of the encircled portion in FIG. 4;
FIG. 11 is an enlarged view of the encircled portion in FIG. 5;
FIG. 12 is an enlarged view of FIG. 6; and,
FIG. 13 is an enlarged view of FIG. 7.
The evenly-dashed broken lines in the drawings depict portions of the smart watch that form no part of the claimed design.
The dot-dot-dash broken lines encircling portions of the claimed design in FIGS. 1, 4, 5 and 9-11 are included to show a partially enlarged view only and form no part of the claimed design.

1 Claim, 9 Drawing Sheets

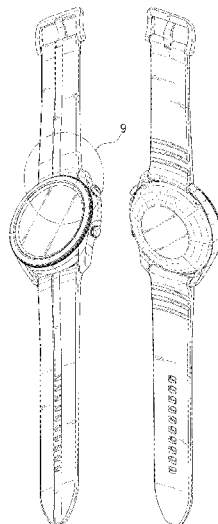

(58) **Field of Classification Search**

USPC D10/122-124, 126, 129-132; D24/167,
D24/186, 187
CPC G04G 17/00; G04G 17/045; G04G 17/08;
G04G 17/083; G04G 21/00; G04G 21/02;
G04G 21/025; G04G 21/06; G04G 21/08;
G04G 99/006; G06F 1/163; A44C
5/0007; A44C 5/0015; A44C 5/0046;
A44C 5/0053; A44C 5/2052; A44C
5/2071

See application file for complete search history.

(56) **References Cited**

U.S. PATENT DOCUMENTS

D690,210 S * 9/2013 Takahashi D10/32
D736,664 S * 8/2015 Paradise D14/344
D739,269 S * 9/2015 Fazio D10/129
D740,136 S * 10/2015 Henne D10/38
D745,421 S * 12/2015 Akana D10/70
D750,625 S * 3/2016 Solomon D14/344
D752,583 S * 3/2016 Solomon D14/344
D755,178 S * 5/2016 Solomon D14/344
D758,889 S * 6/2016 Cerrato D10/30
D773,319 S * 12/2016 Basargin D10/38
D782,335 S * 3/2017 White G04G 21/08
D10/32
D785,469 S * 5/2017 Grcic A44C 5/0053
D10/38
D812,051 S * 3/2018 Park D14/344
D820,140 S * 6/2018 Register D11/3
D823,853 S * 7/2018 Yoshimoto D14/344
D828,832 S * 9/2018 Wang D14/344
D828,833 S * 9/2018 Zhang D14/344
D828,834 S * 9/2018 Zhang D14/344
D844,458 S * 4/2019 Lillquist D10/30
D848,285 S * 5/2019 Inoue D10/30
D848,303 S * 5/2019 Register D11/3
D850,945 S * 6/2019 Akana D10/70
D857,010 S * 8/2019 Choi D14/344
D858,311 S * 9/2019 Zhang D10/30
D860,820 S * 9/2019 Bove A45C 11/10
D10/32
D860,988 S * 9/2019 Haapakoski D14/344
D879,628 S * 3/2020 Akana D10/70
D893,322 S * 8/2020 Xiao D10/70
D900,644 S * 11/2020 Register D14/344
D901,492 S * 11/2020 Gao D14/344

D902,920 S * 11/2020 Bang D14/344
D905,576 S * 12/2020 Lillquist D14/344
D918,059 S * 5/2021 Wang D14/344
D923,004 S * 6/2021 Gao D14/344
D927,485 S * 8/2021 Wu D14/344
D927,991 S * 8/2021 Ide D14/344
D944,100 S * 2/2022 Register D10/128
D945,415 S * 3/2022 Chao D14/344
D948,358 S * 4/2022 Akana D10/70
D951,245 S * 5/2022 Chung D14/344
D953,891 S * 6/2022 Byler D14/344
D955,897 S * 6/2022 Galli D10/32
D956,236 S * 6/2022 Chao D10/38
D956,742 S * 7/2022 Choi D14/344
D960,153 S * 8/2022 Wu D14/344
2009/0274015 A1* 11/2009 Sun A44C 5/0053
368/282
2012/0099406 A1* 4/2012 Lau G04G 21/08
368/69
2022/0146985 A1* 5/2022 Wu G04G 17/045

FOREIGN PATENT DOCUMENTS

CN 2016305032193 4/2017
CN 2017303854624 1/2018
CN 201830314568 3/2019
KR 30-2014-0030535 5/2015
KR 30-2016-0034888 2/2017
KR 301096346.0000 * 2/2021
KR 301127756.0000 * 9/2021
KR 301127757.0000 * 9/2021

OTHER PUBLICATIONS

Samsung Gear S3 Classic Smartwatch, www.amazon.com, Nov. 7, 2018. <https://www.amazon.com/Samsung-Classic-Smartwatch-Bluetooth-SM-R770NZSAXAR/dp/B01M1OXXT8?th=1> (Year: 2018).*

Samsung Galaxy Watch 3, www.amazon.com, Aug. 6, 2020. https://www.amazon.com/Samsung-Bluetooth-Advanced-monitoring-Tracking/dp/B089DNNJIS/ref=psdc_7939901011_t3_B08HL5K8JB (Year: 2020).*

Sidman. "Lg Watch W7 Analog Watch and Smartwatch Encounter Performance Battery" [2019] www.cdmanii.com Jan. 16, 2019 <<https://cdmanii.com/6726>>.

"18mm waterproof silicone watch strap replacement wristband watch strap" [2020] www.item.gmarket.co.kr Sep. 29, 2020 <<http://item.gmarket.co.kr/Item?goodscode=1452784224>>.

* cited by examiner

FIG. 1

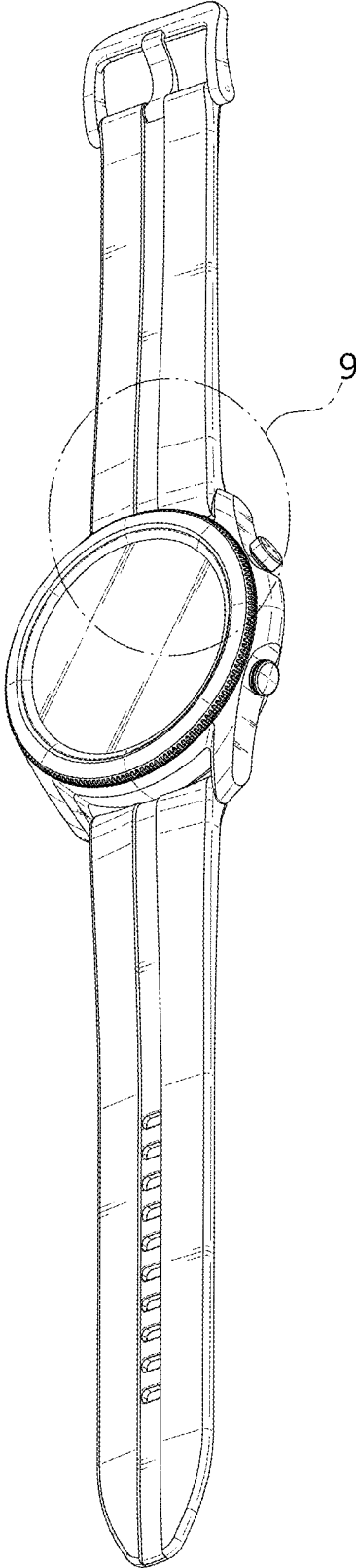

FIG. 2

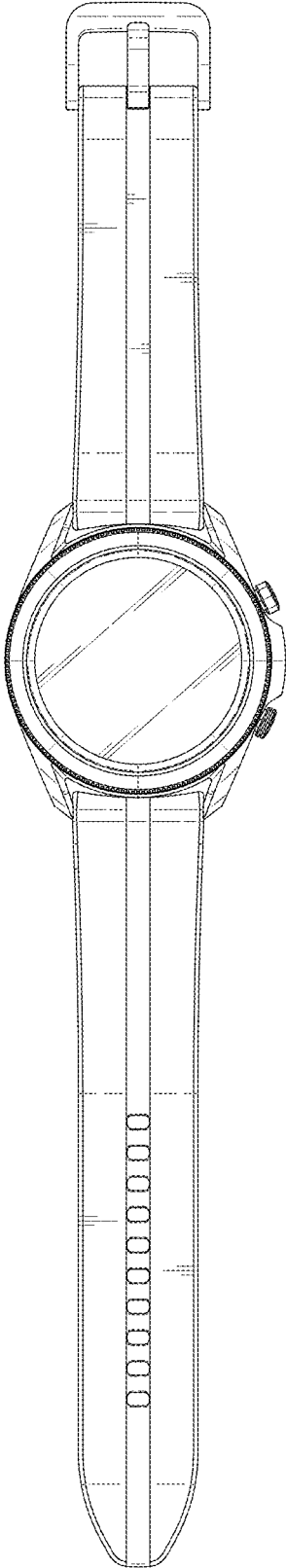

FIG. 3

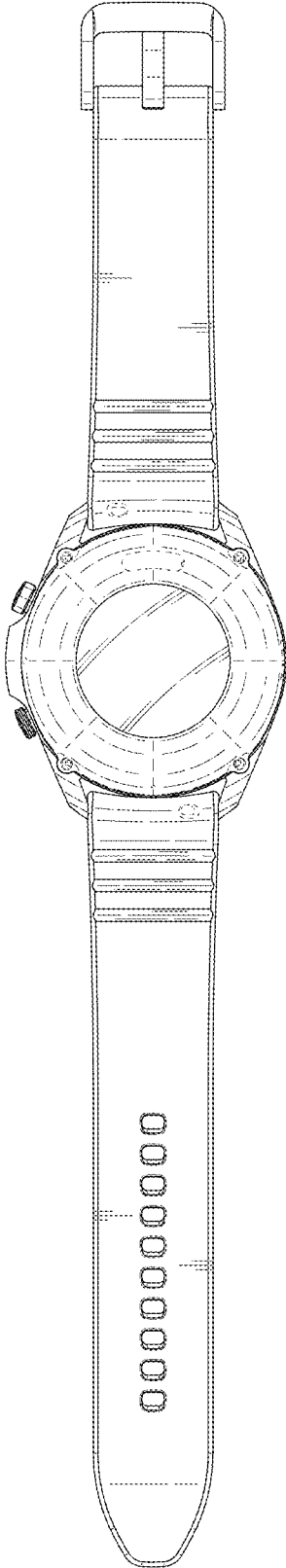

FIG. 4

FIG. 5

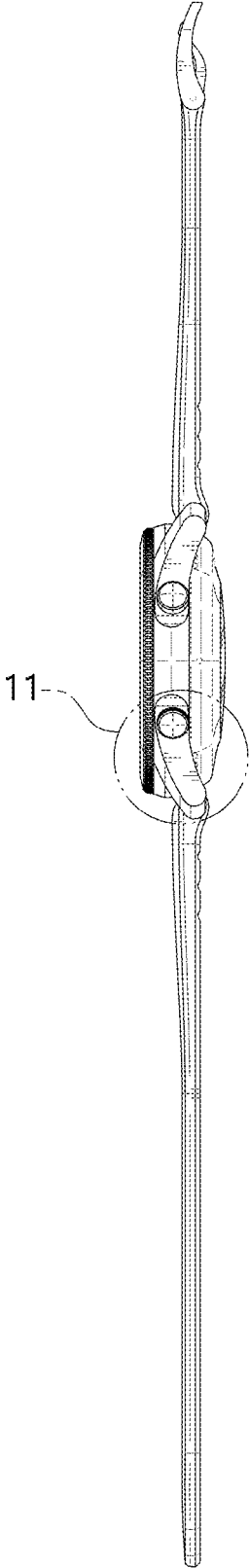
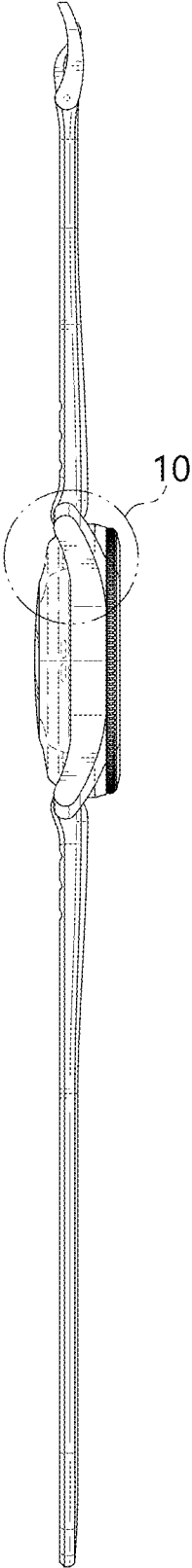

FIG. 6

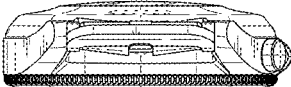

FIG. 7

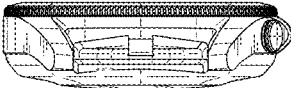

FIG. 8

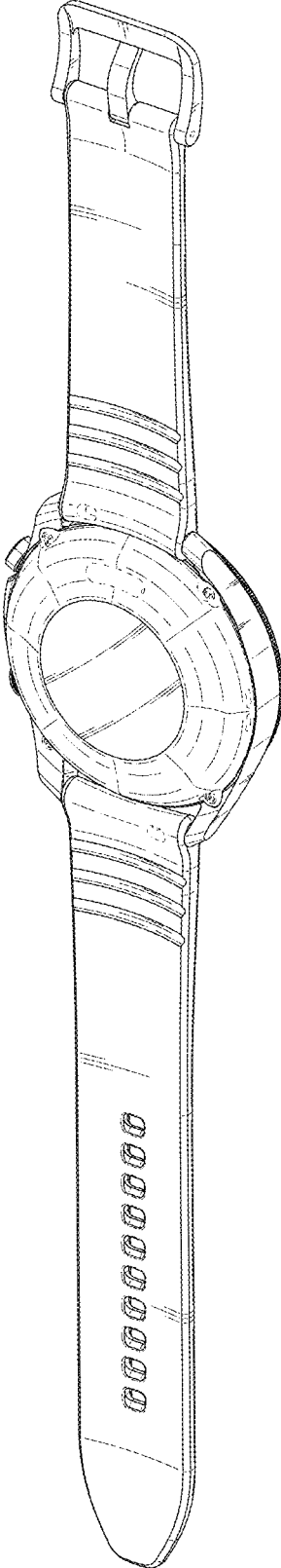

FIG. 9

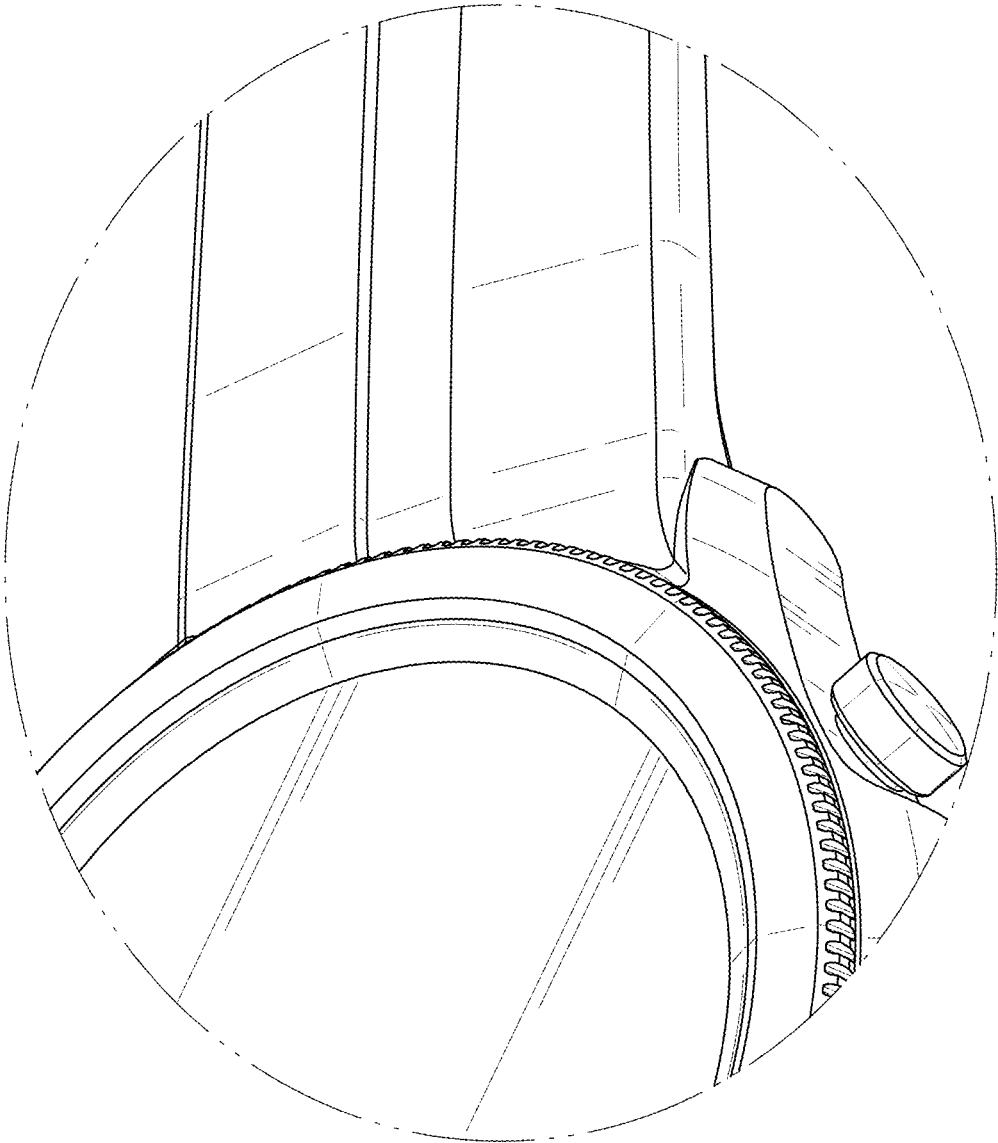

FIG. 10

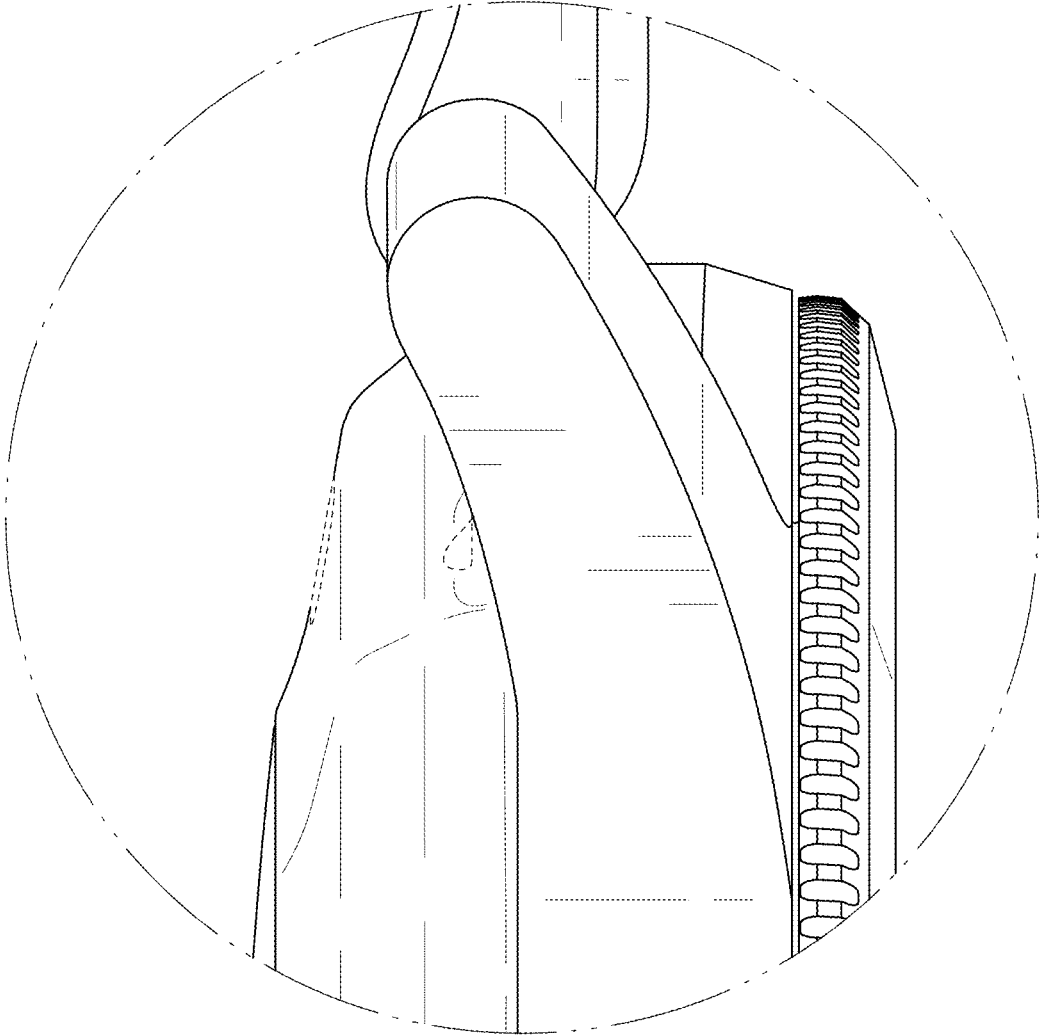

FIG. 11

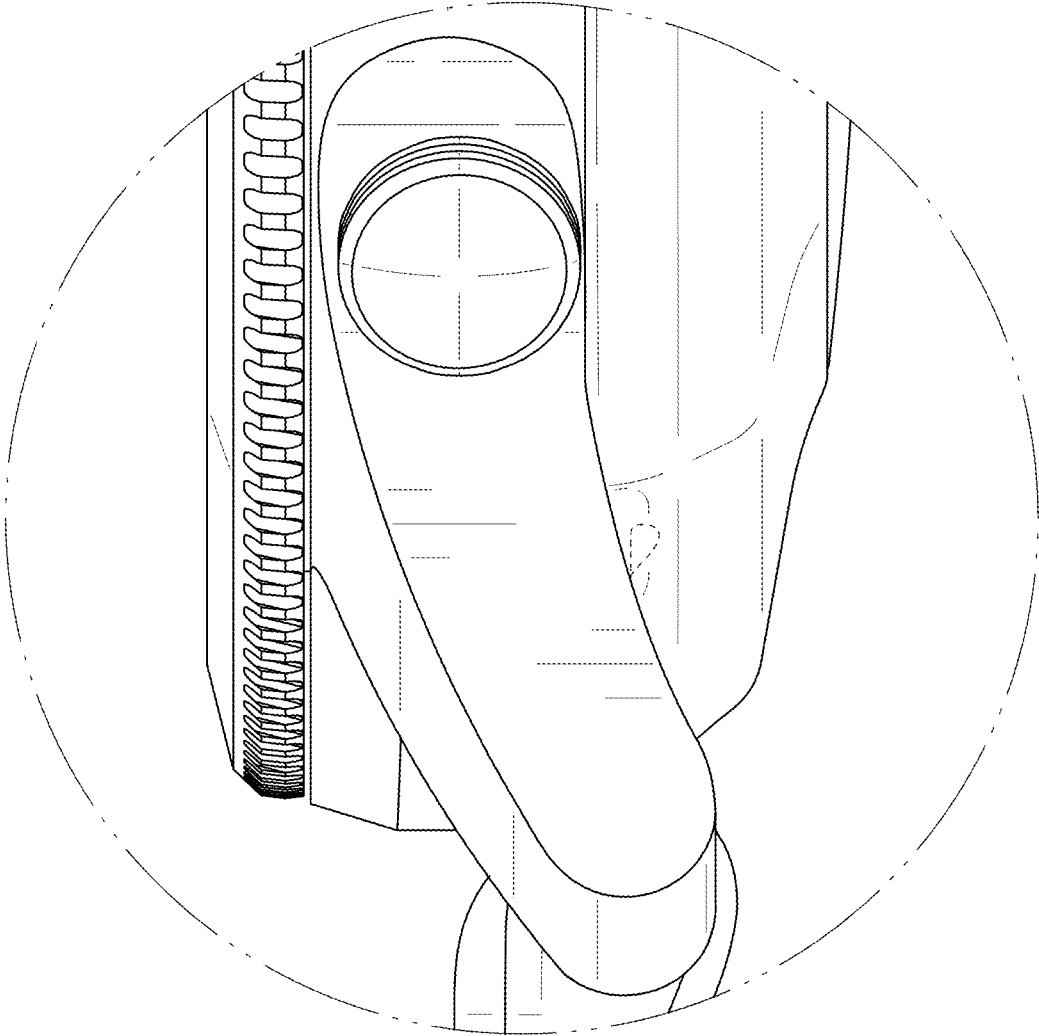

FIG. 12

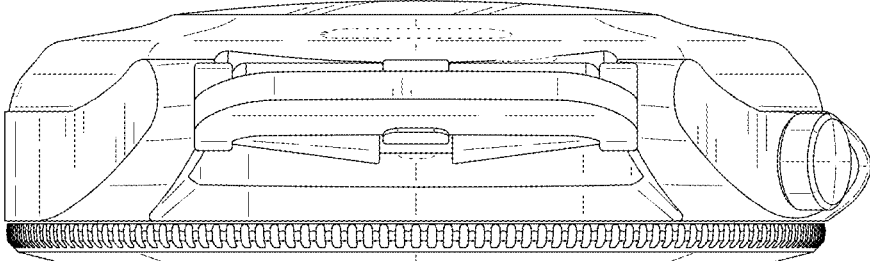

FIG. 13

