



US00D993549S

(12) **United States Design Patent**
Favia

(10) **Patent No.:** **US D993,549 S**
(45) **Date of Patent:** **** Jul. 25, 2023**

- (54) **GROOMING HAIR ACCUMULATOR FOR ANIMAL**
- (71) Applicant: **Spectrum Brands, Inc.**, Middleton, WI (US)
- (72) Inventor: **Adam Favia**, Reedsburg, WI (US)
- (73) Assignee: **Spectrum Brands, Inc.**, Middleton, WI (US)
- (**) Term: **15 Years**
- (21) Appl. No.: **29/838,646**
- (22) Filed: **May 13, 2022**

6,499,175 B1 *	12/2002	Osiecki	A46B 17/02
			15/159.1
D469,613 S *	2/2003	Libman	D4/138
D577,203 S *	9/2008	Meyer	D4/129
D577,204 S	9/2008	Libman et al.	
D580,657 S	11/2008	Libman et al.	
D586,561 S	2/2009	Libman et al.	
D591,513 S	5/2009	Mcneil et al.	
D630,438 S *	1/2011	Raven	D4/138
D632,087 S	2/2011	Wang	
D743,703 S	11/2015	Harrington et al.	
D759,384 S	6/2016	Libman et al.	
D847,515 S	5/2019	Renner et al.	
D853,128 S	7/2019	Tschopp	
D857,399 S	8/2019	Renner et al.	

(Continued)

Primary Examiner — Katrina N Gonzalez
(74) *Attorney, Agent, or Firm* — Merchant & Gould P.C.

Related U.S. Application Data

- (63) Continuation of application No. 29/758,490, filed on Nov. 16, 2020, now Pat. No. Des. 953,660, which is a continuation of application No. 29/641,266, filed on Mar. 20, 2018, now Pat. No. Des. 902,502.
- (51) **LOC (14) Cl.** **30-99**
- (52) **U.S. Cl.**
USPC **D30/158**
- (58) **Field of Classification Search**
USPC D30/158, 159; D4/116–123, 127–129, D4/130–138, 199; D32/40, 52
See application file for complete search history.

References Cited

U.S. PATENT DOCUMENTS

D285,130 S	8/1986	Wilkeson	
D329,752 S *	9/1992	Murphy	D4/129
5,355,545 A *	10/1994	Hoagland	A46B 5/00
			D4/118
D398,427 S *	9/1998	Berti	D4/138
D435,970 S *	1/2001	Osiecki	D4/129
6,367,422 B1	4/2002	Wilhelmi	

(57) **CLAIM**

The ornamental design for a grooming hair accumulator for animal, as shown and described.

DESCRIPTION

FIG. 1 is a top perspective view of the new design; FIG. 2 is a bottom perspective view of the new design; FIG. 3 is a top view of the new design; FIG. 4 is a bottom view of the new design; FIG. 5 is a right side view the new design, the left side view being a mirror image thereof; FIG. 6 is another perspective view, but shown with the handle and head separated for completeness of illustration; FIG. 7 is another perspective view, but shown with the handle removed for completeness of illustration; FIG. 8 is another perspective view thereof; and, FIG. 9 is another perspective view thereof.

The broken lines illustrate portions of the grooming hair accumulator for animal that forms no part of the claimed design.

1 Claim, 9 Drawing Sheets

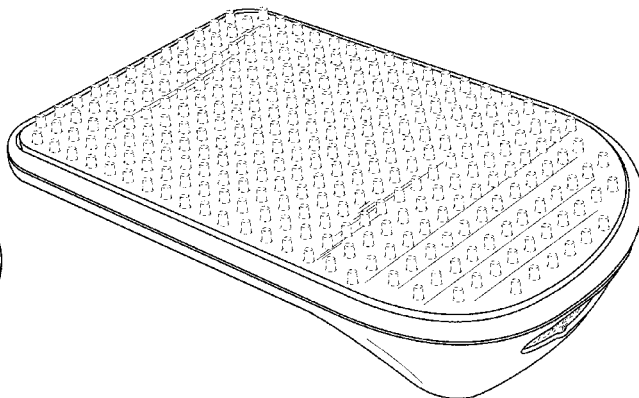
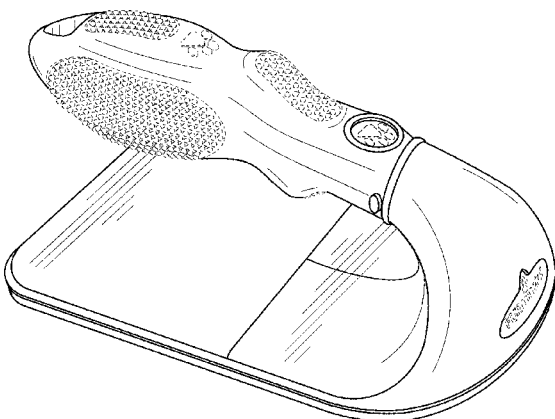

(56)

References Cited

U.S. PATENT DOCUMENTS

D902,502 S	11/2020	Favia	
D953,660 S *	5/2022	Favia	D30/158
2014/0158151 A1	6/2014	Sebagereka et al.	

* cited by examiner

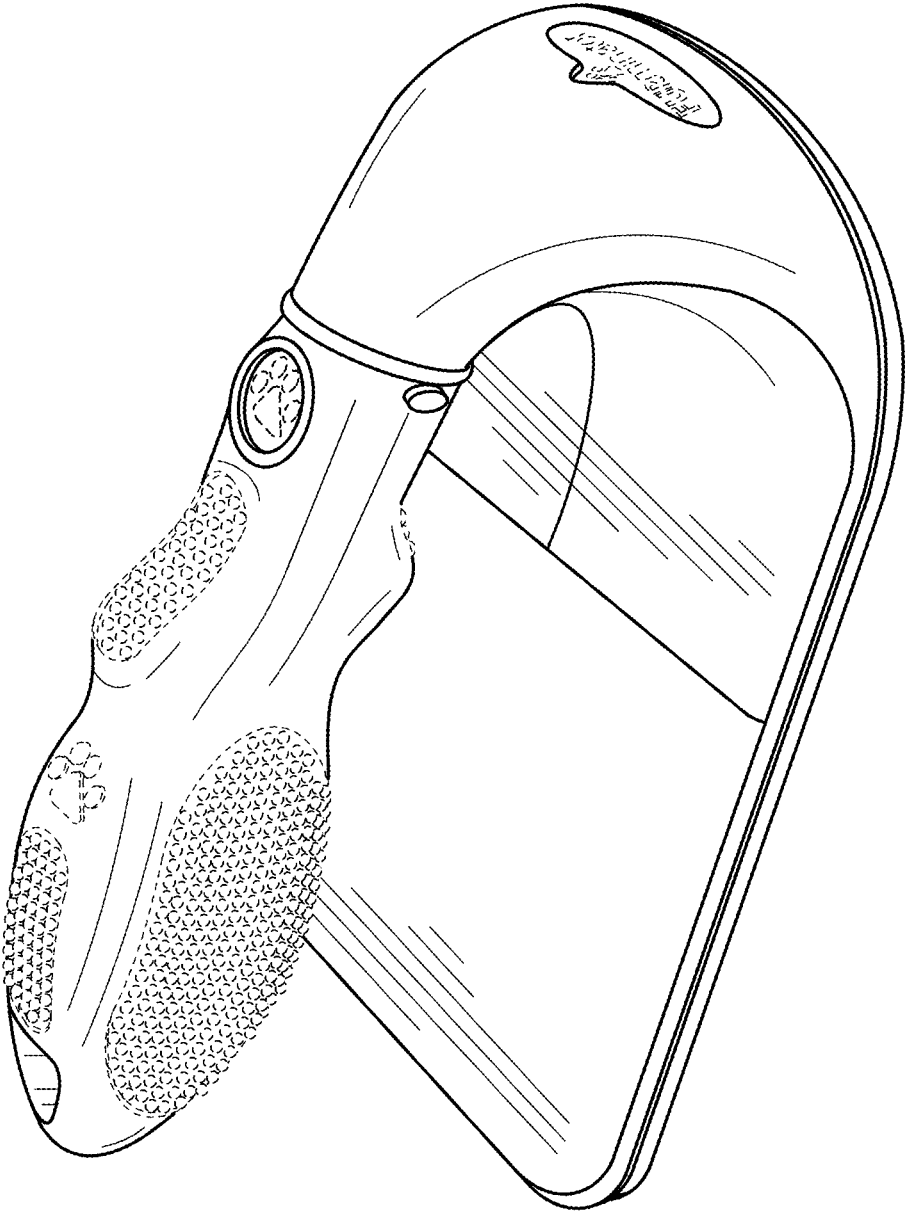

FIG. 1

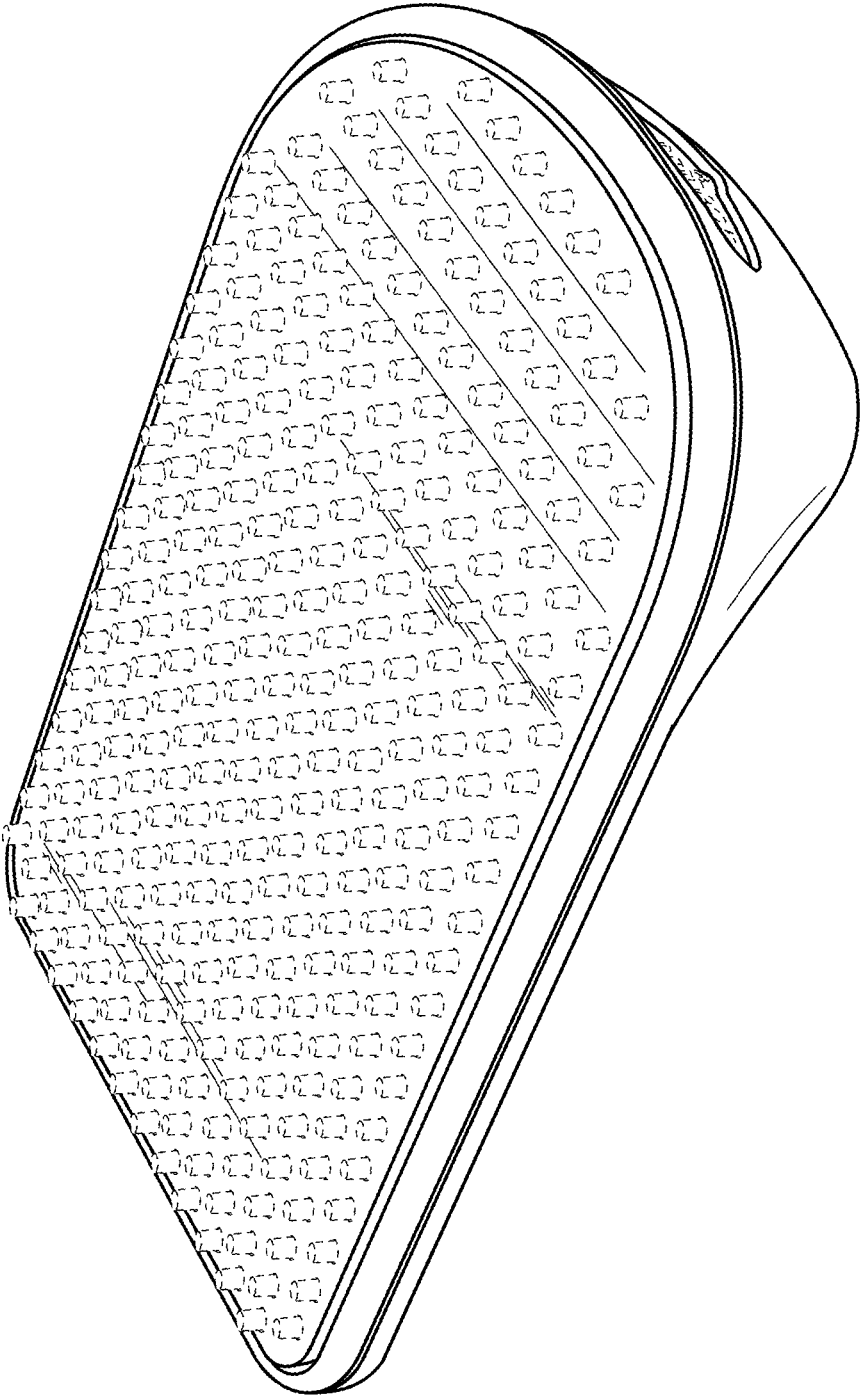

FIG. 2

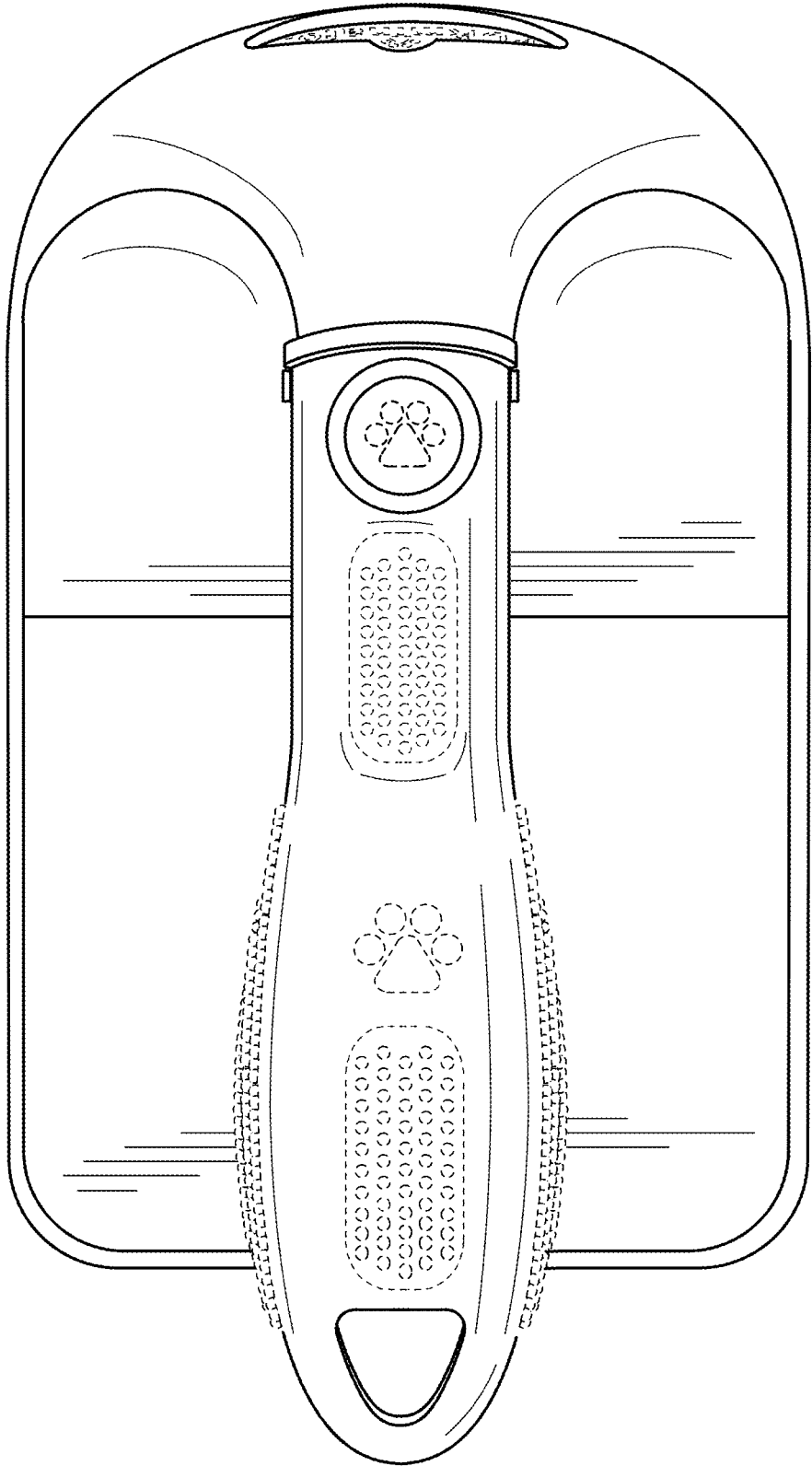

FIG. 3

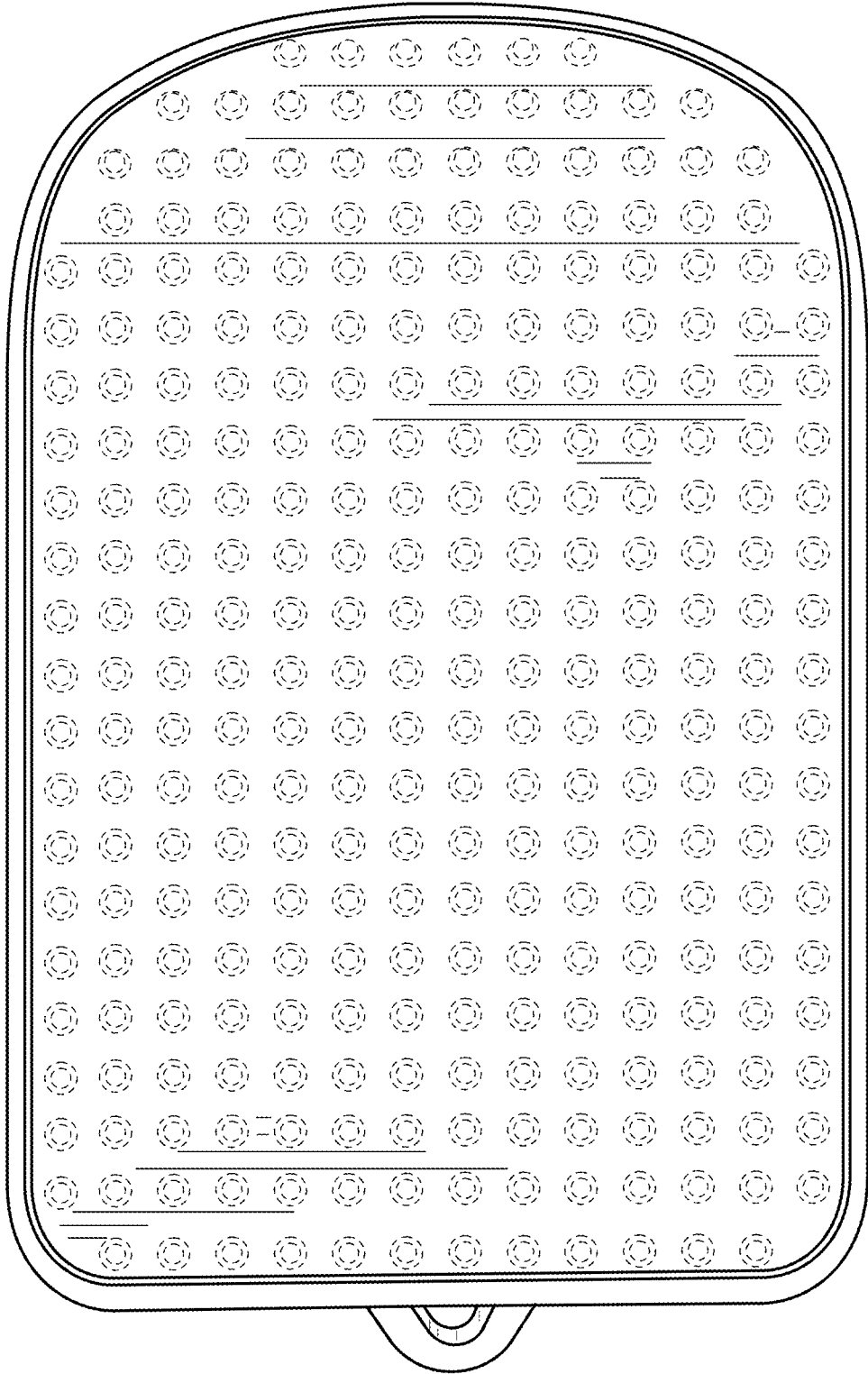

FIG. 4

FIG. 5

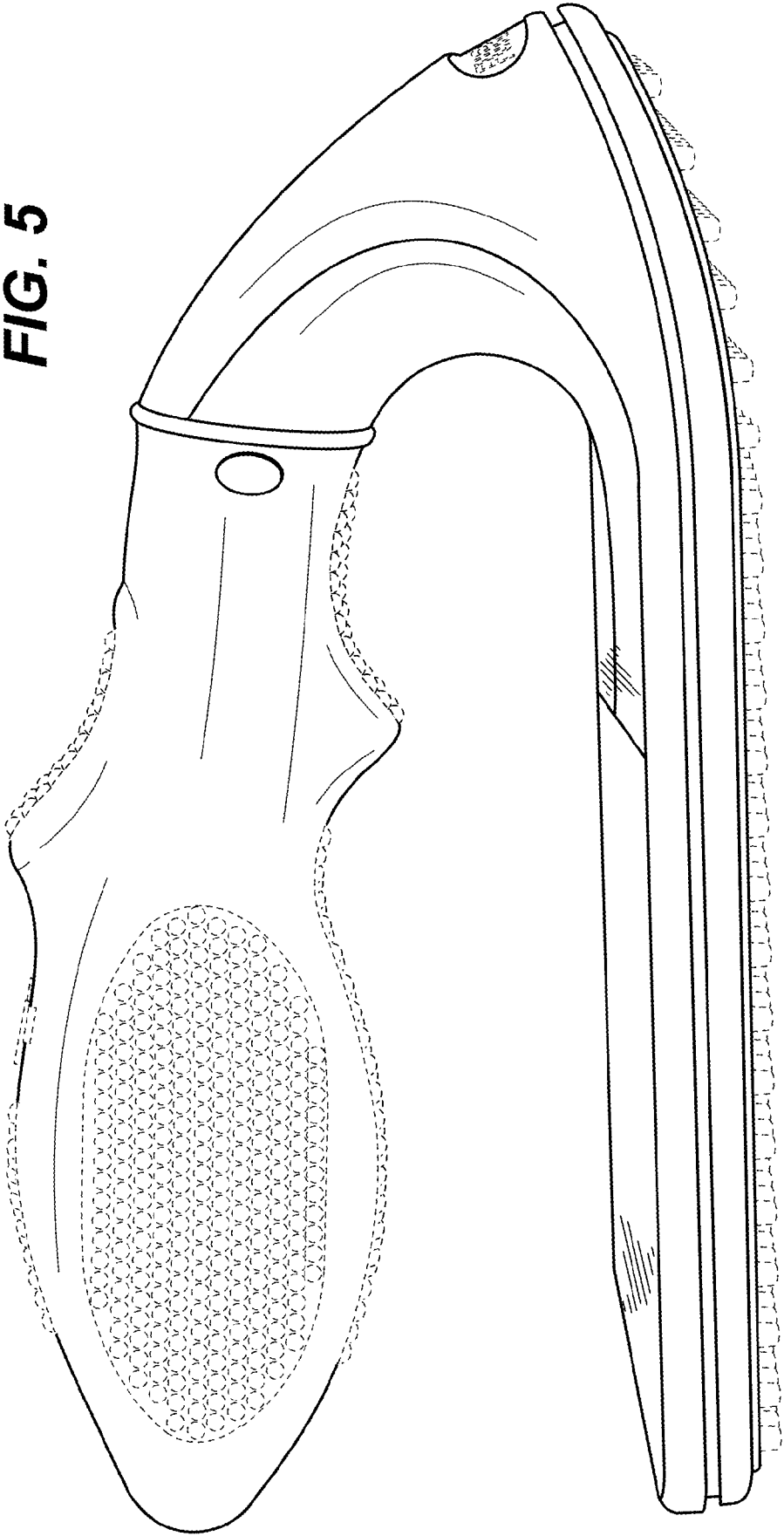
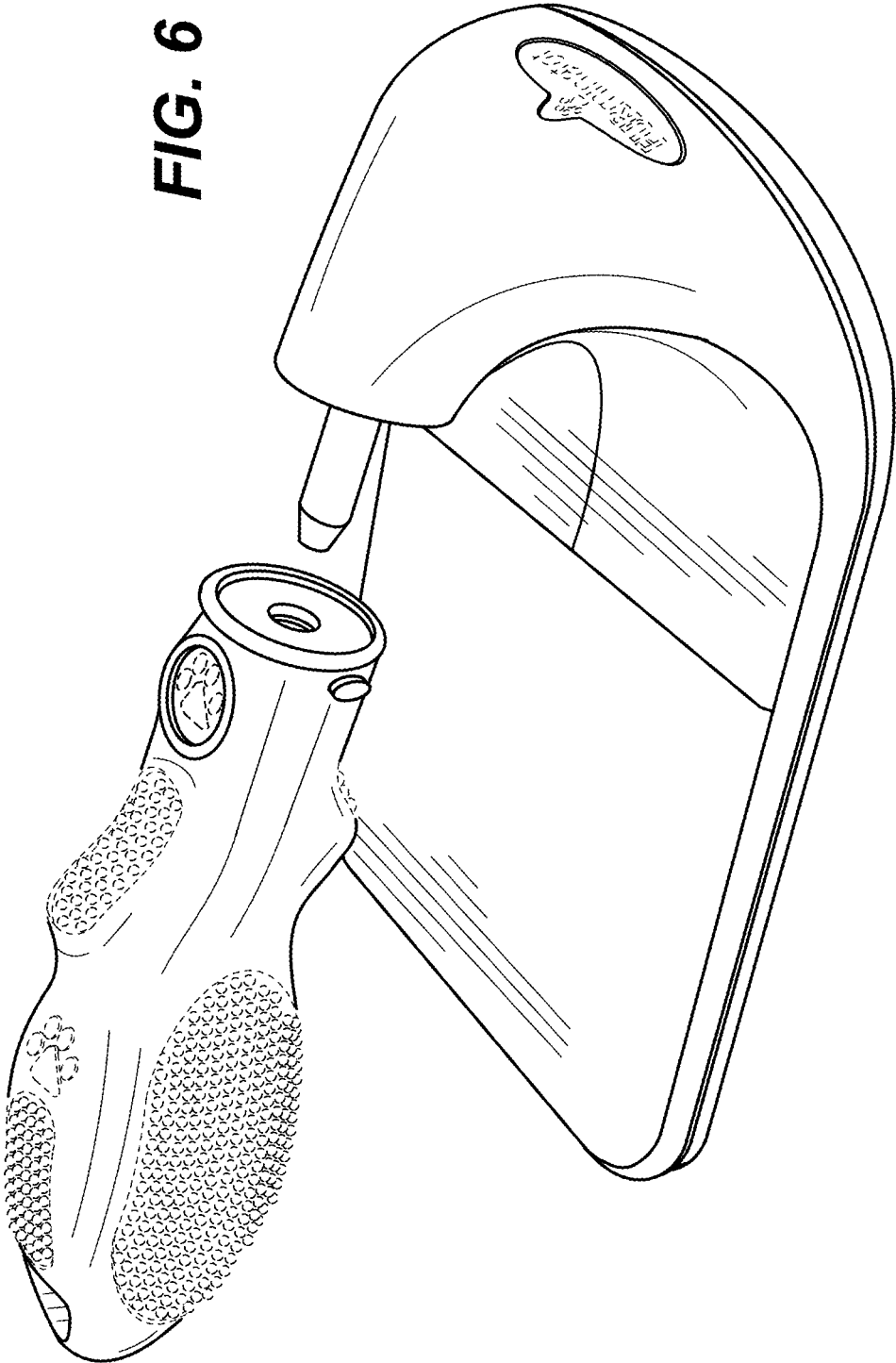

FIG. 6



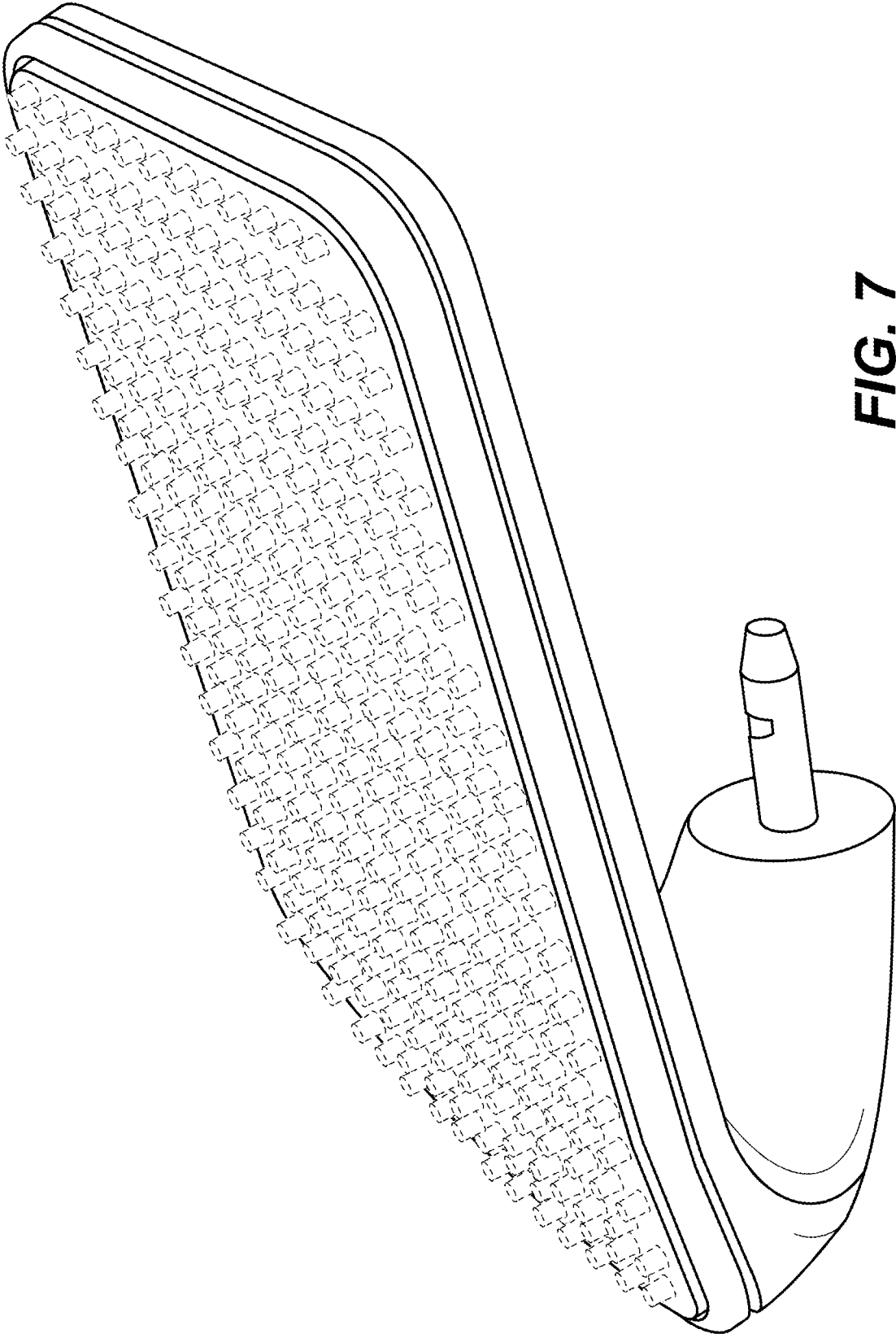

FIG. 7

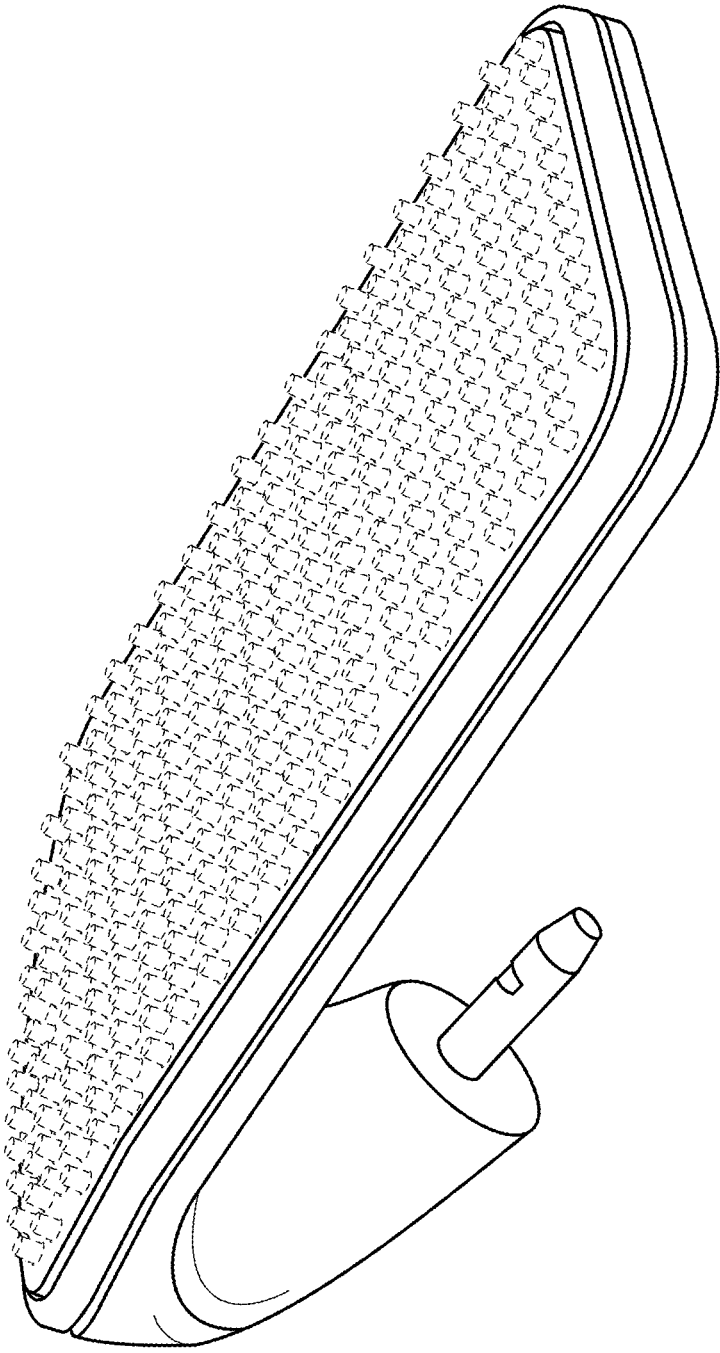

FIG. 8

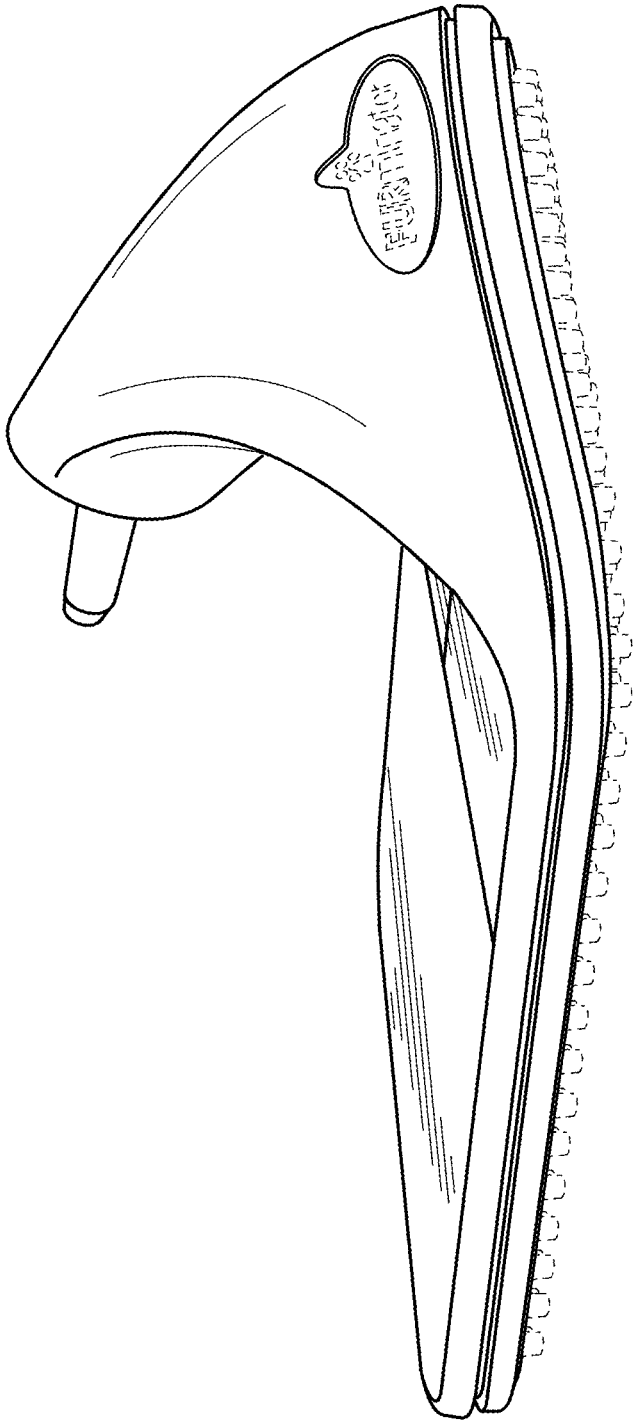

FIG. 9