



US00D979232S

(12) **United States Design Patent** (10) **Patent No.:** **US D979,232 S**
Spaziani (45) **Date of Patent:** **** Feb. 28, 2023**

(54) **HANDBAG**

D882,249 S * 4/2020 Nair D3/243
10,617,188 B1 * 4/2020 Hooks G08B 21/0297
D922,764 S * 6/2021 Spaziani D3/243

(71) Applicant: **LOUIS VUITTON MALLETIER,**
Paris (FR)

FOREIGN PATENT DOCUMENTS

(72) Inventor: **Darren Spaziani,** Paris (FR)

CN 202030115255.9 * 9/2020
EM 007770227-0001 * 3/2020
FR 20194297-001 * 10/2019

(73) Assignee: **LOUIS VUITTON MALLETIER,**
Paris (FR)

(Continued)

(**) Term: **15 Years**

OTHER PUBLICATIONS

(21) Appl. No.: **29/729,281**

“LV Pont 9”, louisvuitton.com, site visited Feb. 10, 2022: <https://us.louisvuitton.com/eng-us/products/lv-pont-9-smooth-calfskin-leather-nvprod2290051v#M55948> (Year: 2022).*

(22) Filed: **Mar. 25, 2020**

(Continued)

(30) **Foreign Application Priority Data**

Oct. 2, 2019 (FR) 2019-4297

(51) **LOC (14) Cl.** **03-01**

(52) **U.S. Cl.**
USPC **D3/243**

(58) **Field of Classification Search**
USPC D3/232–234, 238–240, 242–243,
D3/245–246, 905

CPC A45C 15/00; A45C 3/06; A45C 5/005;
A45C 9/00

See application file for complete search history.

Primary Examiner — Jennifer L Watkins

Assistant Examiner — Samantha Lynne Brodowski

(74) *Attorney, Agent, or Firm* — Fross, Zelnick, Lehrman & Zissu PC; Charles T. J. Weigell, Esq.

(57) **CLAIM**

The ornamental design for a handbag, as shown and described.

DESCRIPTION

FIG. 1 is a front perspective view of a handbag showing my new design;

FIG. 2 is a front view thereof;

FIG. 3 is a back view thereof;

FIG. 4 is left side view thereof;

FIG. 5 is a right side view thereof;

FIG. 6 is a top view thereof; and,

FIG. 7 is a bottom view thereof, with the shoulder strap shown in an alternate position.

The broken lines that depict the inner edge of the closure flap in FIGS. 1, 4, 5, and 7 are for the purpose of showing portions of the article that form no part of the claim.

1 Claim, 5 Drawing Sheets

(56) **References Cited**

U.S. PATENT DOCUMENTS

D268,304 S * 3/1983 Schimmel D10/31
D324,770 S * 3/1992 Dixsaut D3/243
D770,176 S * 11/2016 Guyon D3/243
D787,820 S * 5/2017 Nair D3/243
D799,818 S * 10/2017 Nair D3/243
D806,384 S * 1/2018 Lopez Montoya D3/243
D818,706 S * 5/2018 Maier D3/232
D831,347 S * 10/2018 Marzin D3/243
D838,976 S * 1/2019 Colonna D3/243
D869,155 S * 12/2019 Venturini Fendi D3/243

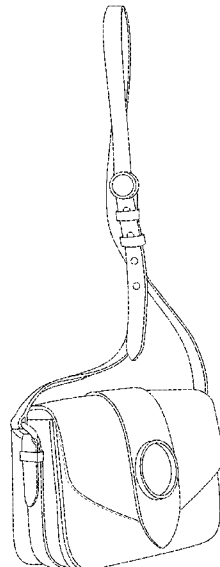

(56)

References Cited

FOREIGN PATENT DOCUMENTS

FR	20195337-001	*	6/2020
GB	9007770227-0001	*	3/2020

OTHER PUBLICATIONS

“The Louis Vuitton Pont 9 is the shoulder bag we have been waiting for”, first available May 28, 2020, luxurylaunches.com, site visited Feb. 10, 2022: [https://luxurylaunches.com/fashion/the-louis-vuitton-pont-9-is-a-shoulder-bag-we-have-been-waiting-for.php#:~:text=The %20LV%20Pont%20bag%20is%20slated%20to%20release%20in,on%20May%20for%20%243285](https://luxurylaunches.com/fashion/the-louis-vuitton-pont-9-is-a-shoulder-bag-we-have-been-waiting-for.php#:~:text=The%20LV%20Pont%20bag%20is%20slated%20to%20release%20in,on%20May%20for%20%243285) (Year: 2020).*

* cited by examiner

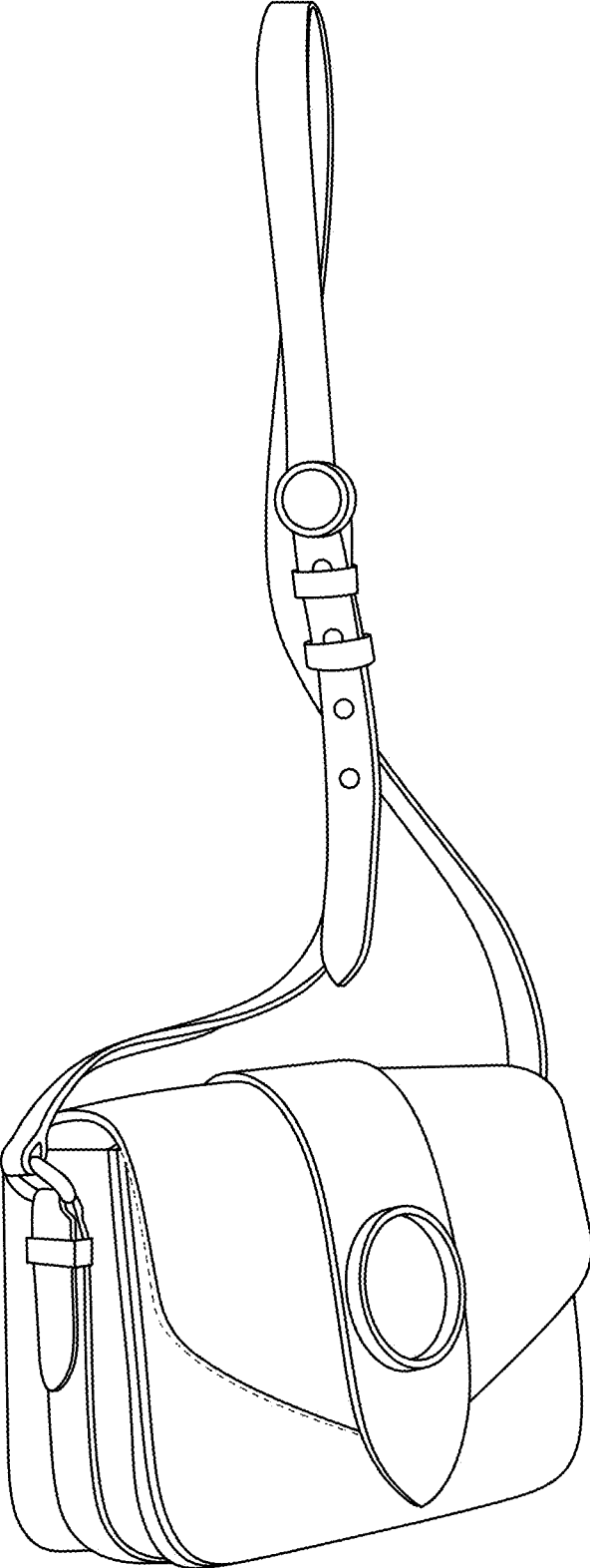

FIG. 1

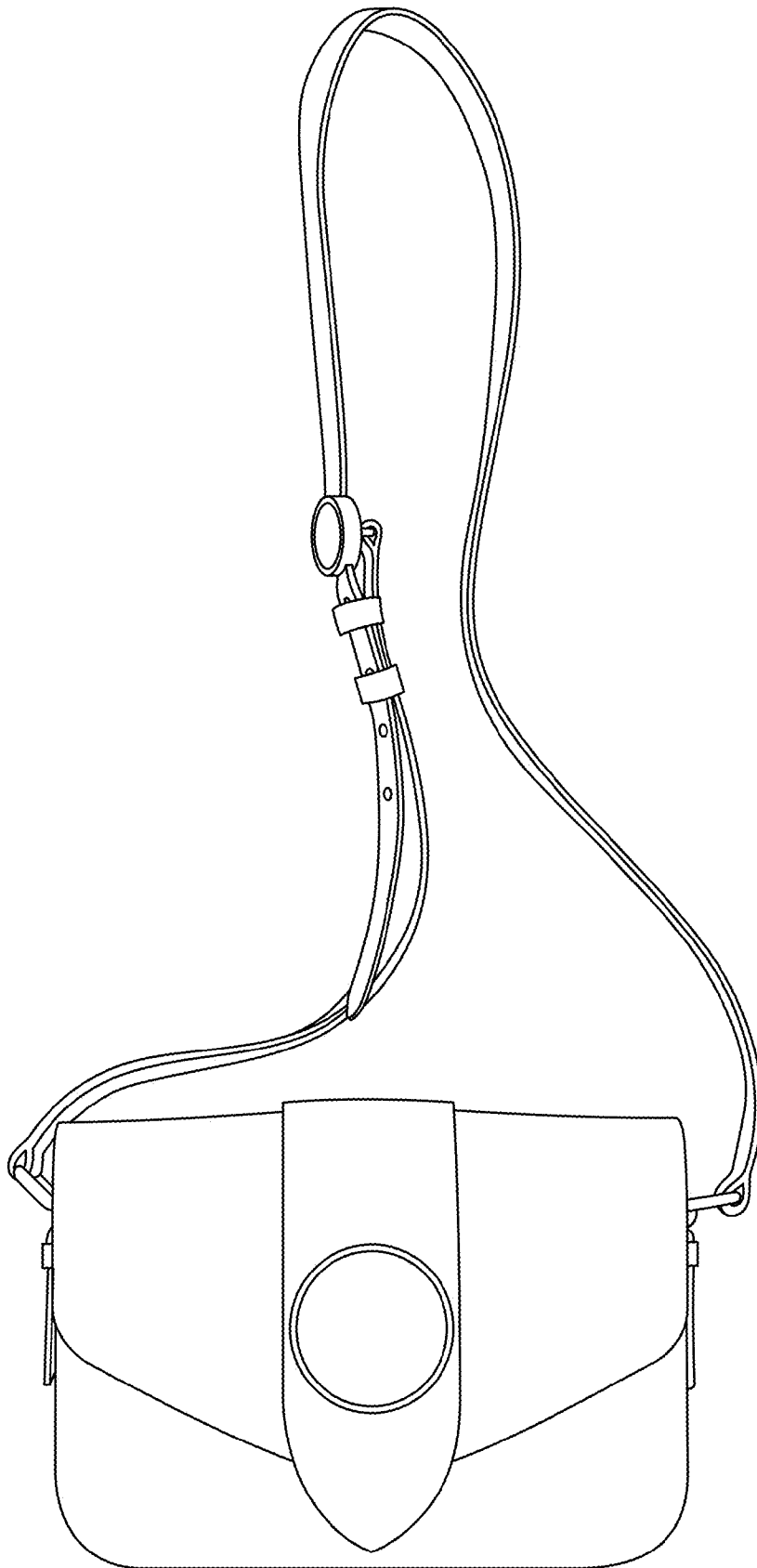

FIG. 2

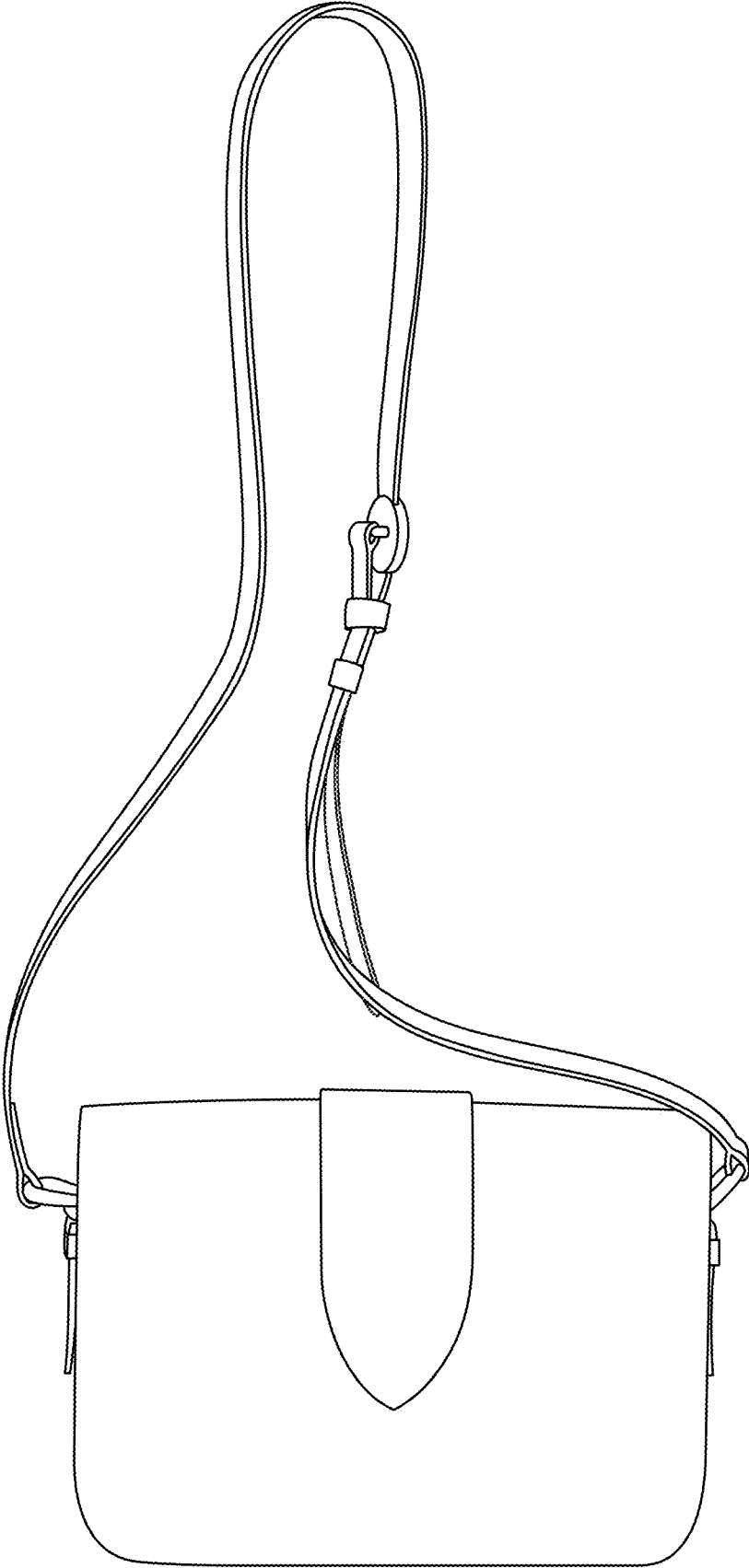

FIG. 3

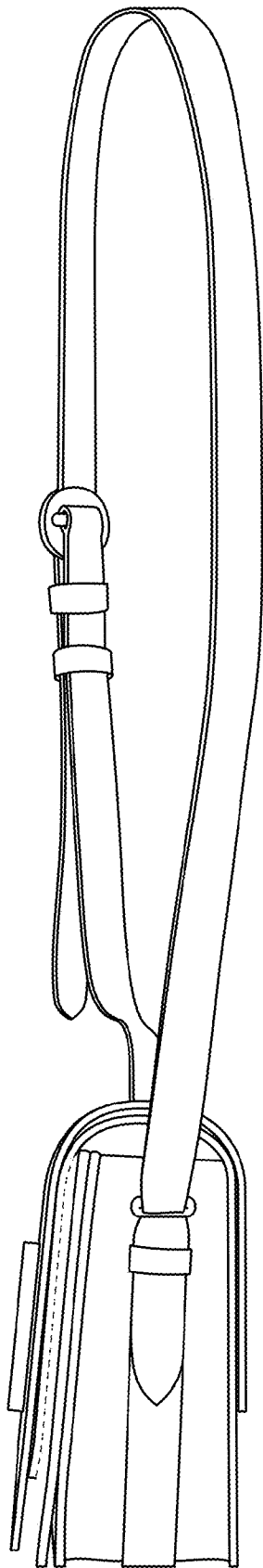

FIG. 4

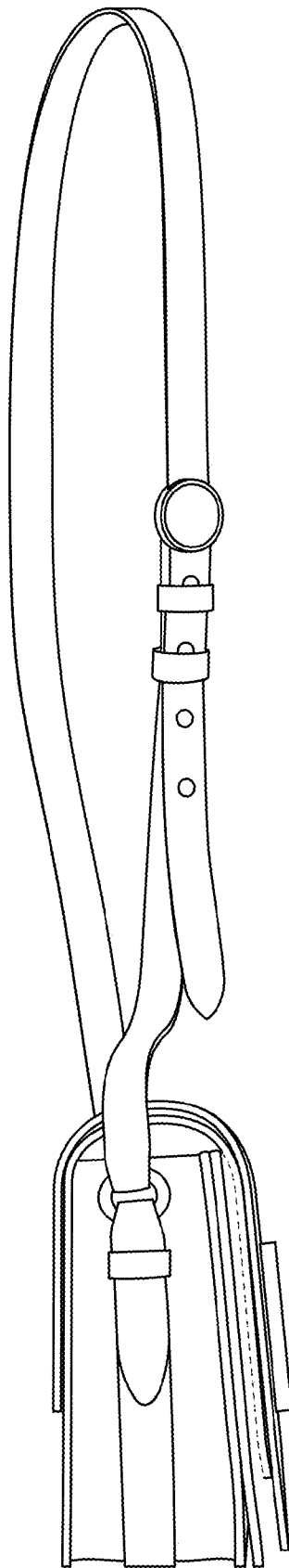

FIG. 5

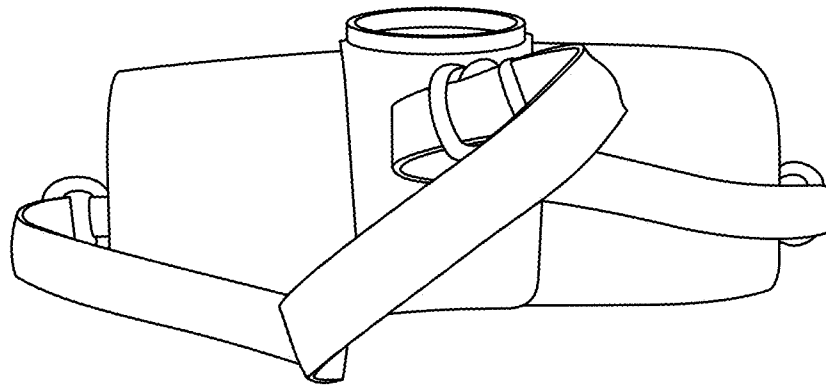

FIG. 6

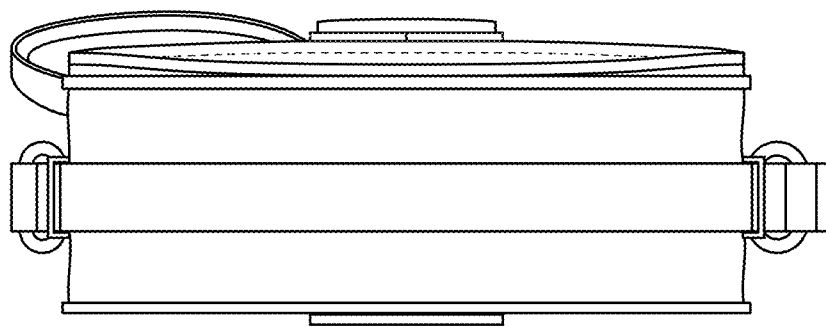

FIG. 7