



US00D522989S

(12) **United States Design Patent** (10) **Patent No.:** **US D522,989 S**  
**Viitasaari** (45) **Date of Patent:** **\*\* Jun. 13, 2006**

(54) **HANDSET**  
(75) Inventor: **Sami Viitasaari, Ii (FI)**  
(73) Assignee: **Nokia Corporation, Espoo (FI)**  
(\*\*) Term: **14 Years**  
(21) Appl. No.: **29/218,969**  
(22) Filed: **Dec. 10, 2004**  
(30) **Foreign Application Priority Data**

Jun. 11, 2004 (FI) ..... M20040101

(51) **LOC (8) Cl.** ..... **14-03**  
(52) **U.S. Cl.** ..... **D14/138**  
(58) **Field of Classification Search** ..... D14/137,  
D14/138, 147-148, 247-248, 144, 341-347;  
379/433.01-433.13, 434; D21/517; 455/575.3,  
455/566, 575.1; 345/169; 348/376, 14.02  
See application file for complete search history.

(56) **References Cited**

**U.S. PATENT DOCUMENTS**

5,436,954	A	*	7/1995	Nishiyama et al.	.....	455/566
5,493,690	A	*	2/1996	Shimazaki	.....	455/575.3
D430,566	S	*	9/2000	Chu et al.	.....	D14/345
6,389,267	B1	*	5/2002	Imai	.....	455/90.1
D459,326	S	*	6/2002	Nagai et al.	.....	D14/138
D476,303	S	*	6/2003	Lee et al.	.....	D14/138
D477,293	S	*	7/2003	Hwang	.....	D14/138
D484,863	S	*	1/2004	Chan	.....	D14/138
D485,249	S	*	1/2004	Liao et al.	.....	D14/138
D486,809	S	*	2/2004	Hwang	.....	D14/138
6,701,162	B1	*	3/2004	Everett	.....	455/556.1
D490,793	S	*	6/2004	Tsai et al.	.....	D14/138
D495,672	S	*	9/2004	Jeon et al.	.....	D14/138
D500,480	S	*	1/2005	Daw	.....	D14/138

(Continued)

**FOREIGN PATENT DOCUMENTS**

EM	000169750-0001	7/2004
EM	000169750-0002	7/2004
EM	000169750-0003	7/2004

EM	000169750-0004	7/2004
EM	000223516-0001	11/2004
EM	000223516-0002	11/2004
EM	000223516-0003	11/2004
FI	23818	5/2005
JP	1188710	* 10/2003
WO	DM/058624	* 12/2001
WO	DM/063714	7/2003
WO	DM/064218	10/2003
WO	DM/065421	7/2004
WO	DM/066167	* 12/2004
WO	DM/066629	* 5/2005
WO	DM/066630	* 5/2005

*Primary Examiner*—Jeffrey Asch  
(74) *Attorney, Agent, or Firm*—Banner & Witcoff, Ltd.

(57) **CLAIM**

The ornamental design for a handset, as shown and described.

**DESCRIPTION**

FIG. 1 is a bottom plan view of a handset showing my new design;  
FIG. 2 is a right side view thereof;  
FIG. 3 is a front view thereof;  
FIG. 4 is a left side view thereof;  
FIG. 5 is a top plan view thereof;  
FIG. 6 is a perspective front view thereof;  
FIG. 7 is a perspective rear view thereof;  
FIG. 8 is a rear view thereof;  
FIG. 9 is a front view of the handset of FIGS. 1-8 in an in-use position;  
FIG. 10 is a perspective front view of the handset of FIGS. 1-8 in an in-use position;  
FIG. 11 is a right side view of the handset of FIGS. 1-8 in an in-use position;  
FIG. 12 is a left side view of the handset of FIGS. 1-8 in an in-use position;  
FIG. 13 is a rear view of the handset of FIGS. 1-8 in an in-use position; and,  
FIG. 14 is a perspective rear view of the handset of FIGS. 1-8 in an in-use position.

**1 Claim, 9 Drawing Sheets**

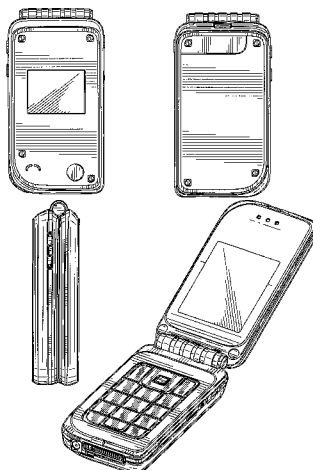

U.S. PATENT DOCUMENTS

D503,697 S	*	4/2005	Kim .....	D14/138	2003/0092401 A1 *	5/2003	Ikeuchi .....	455/90
D504,406 S	*	4/2005	Cho et al. ....	D14/138	2003/0125079 A1 *	7/2003	Park et al. ....	455/556
D506,737 S	*	6/2005	Koo et al. ....	D14/138	2004/0120514 A1 *	6/2004	Kitada .....	379/428.01
D507,251 S	*	7/2005	Burns et al. ....	D14/138	2004/0142718 A1 *	7/2004	Kim .....	455/550.1
D507,551 S	*	7/2005	Kim et al. ....	D14/138	2004/0142721 A1 *	7/2004	Kim .....	455/550.1
D507,562 S	*	7/2005	Kim .....	D14/247	2004/0203535 A1 *	10/2004	Kim et al. ....	455/90.3
D508,035 S	*	8/2005	Kim et al. ....	D14/138	2005/0003852 A1 *	1/2005	Song .....	455/550.1
D508,475 S	*	8/2005	Wu et al. ....	D14/138	2005/0130718 A1 *	6/2005	Woo .....	455/575.3
D509,816 S	*	9/2005	Kim et al. ....	D14/138				

\* cited by examiner

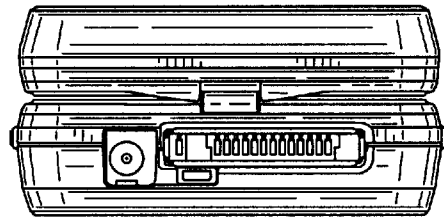

FIG. 1

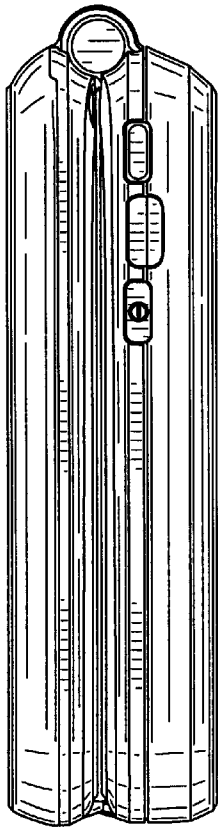

FIG. 2

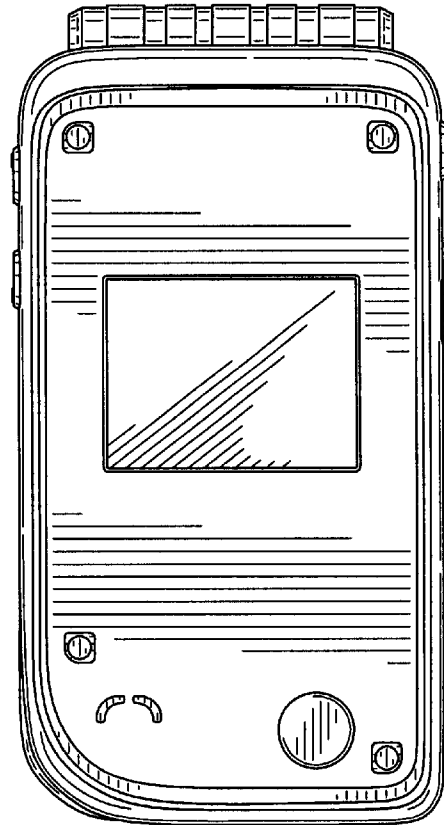

FIG. 3

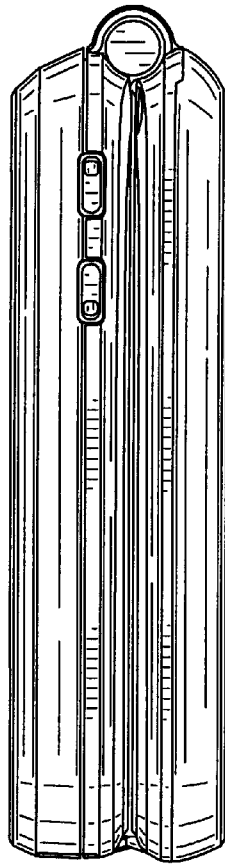

FIG. 4

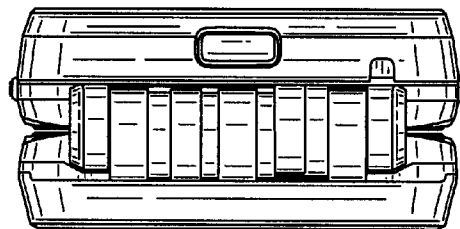

FIG. 5

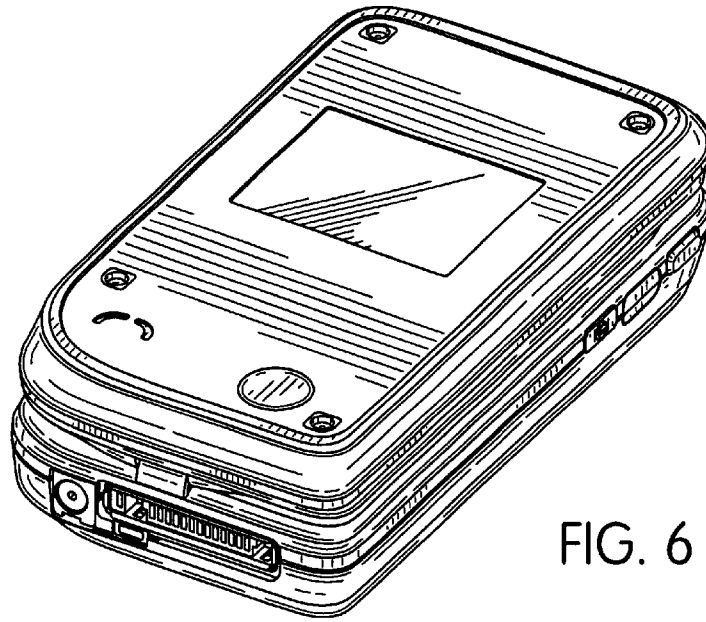

FIG. 6

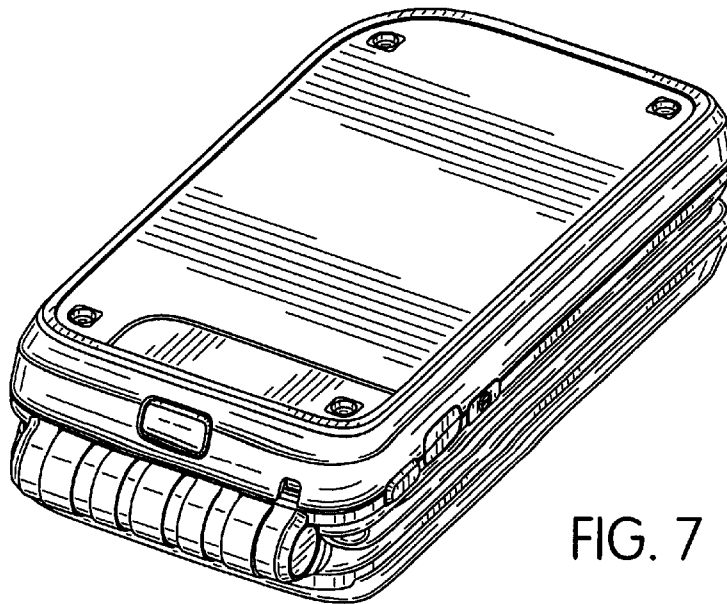

FIG. 7

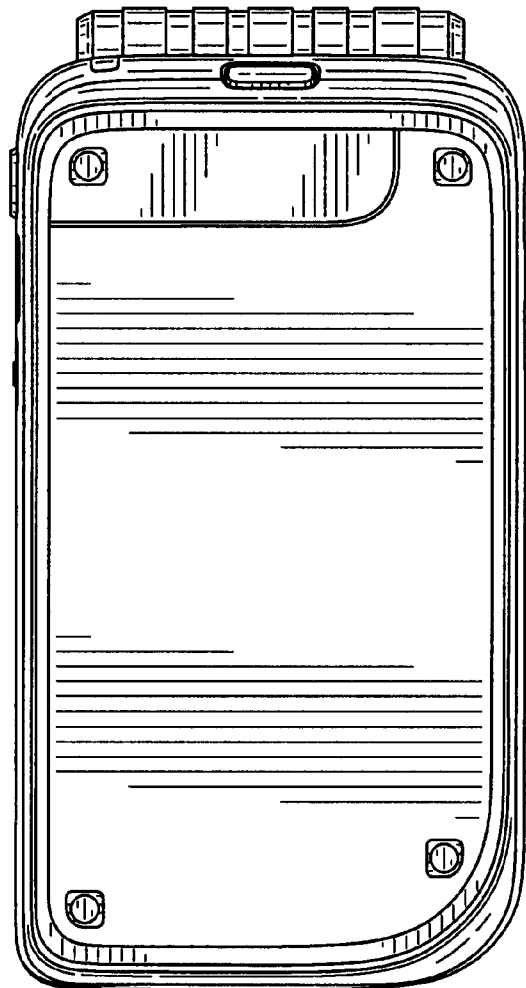

FIG. 8

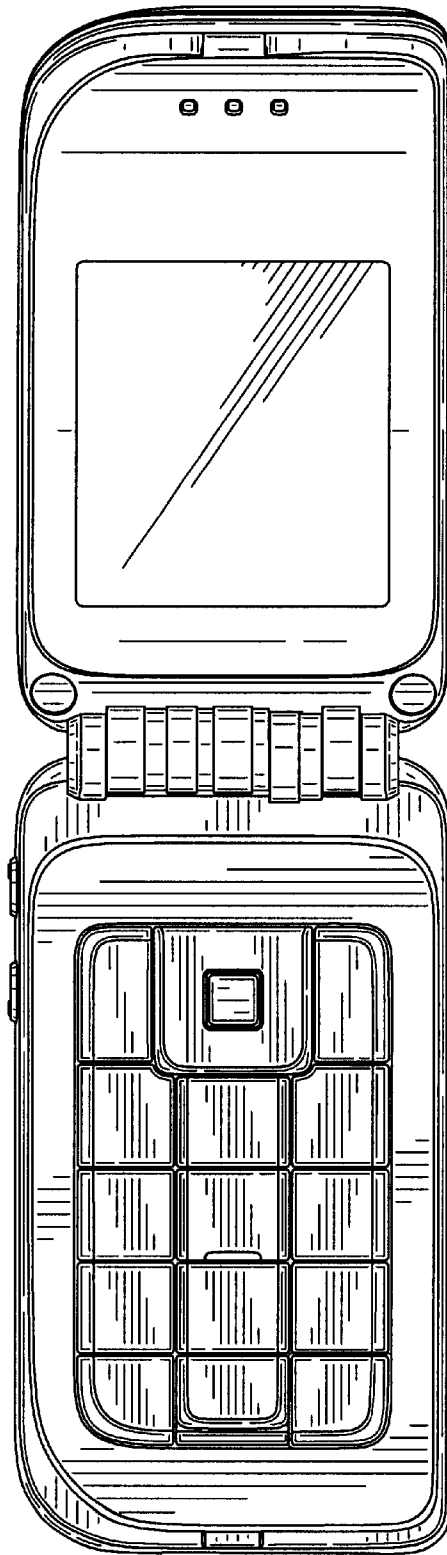

FIG. 9

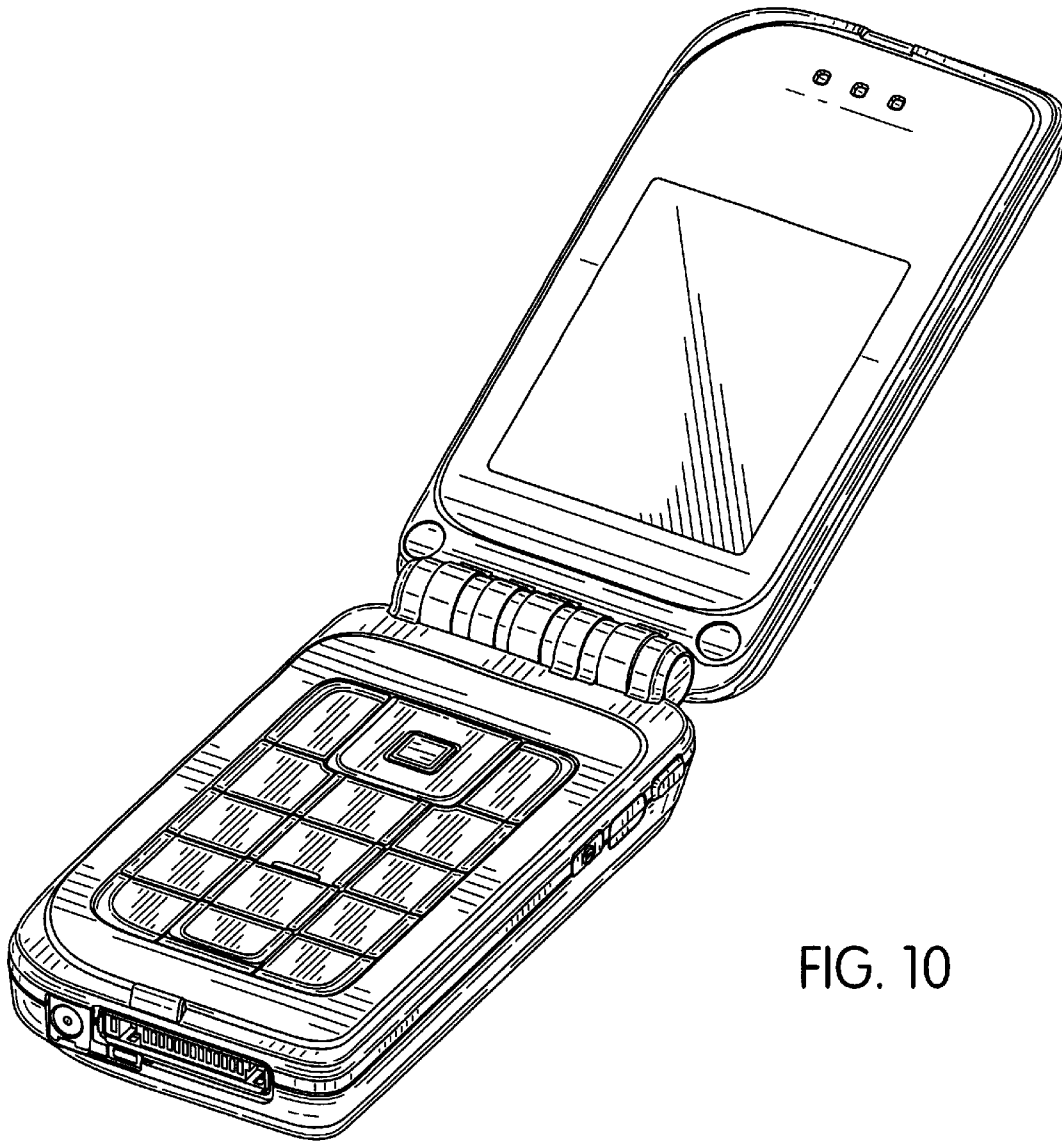

FIG. 10

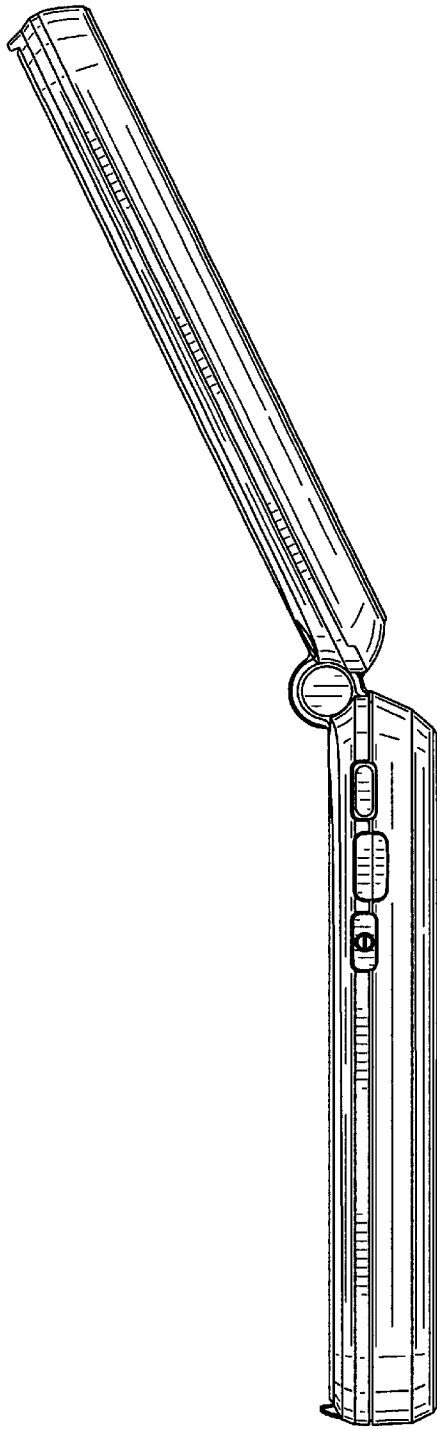

FIG. 11

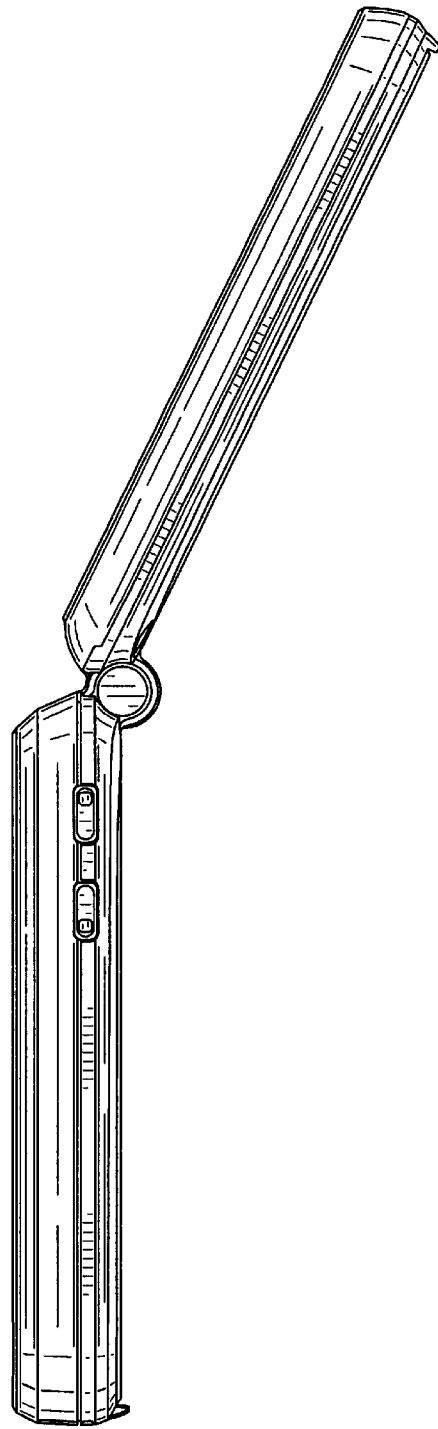

FIG. 12

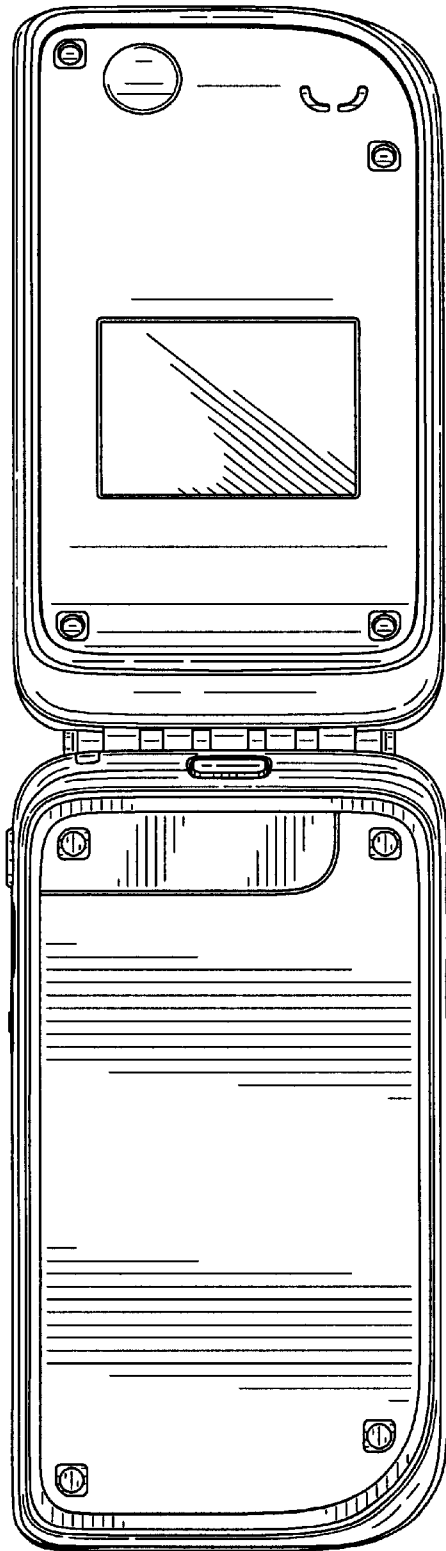

FIG. 13

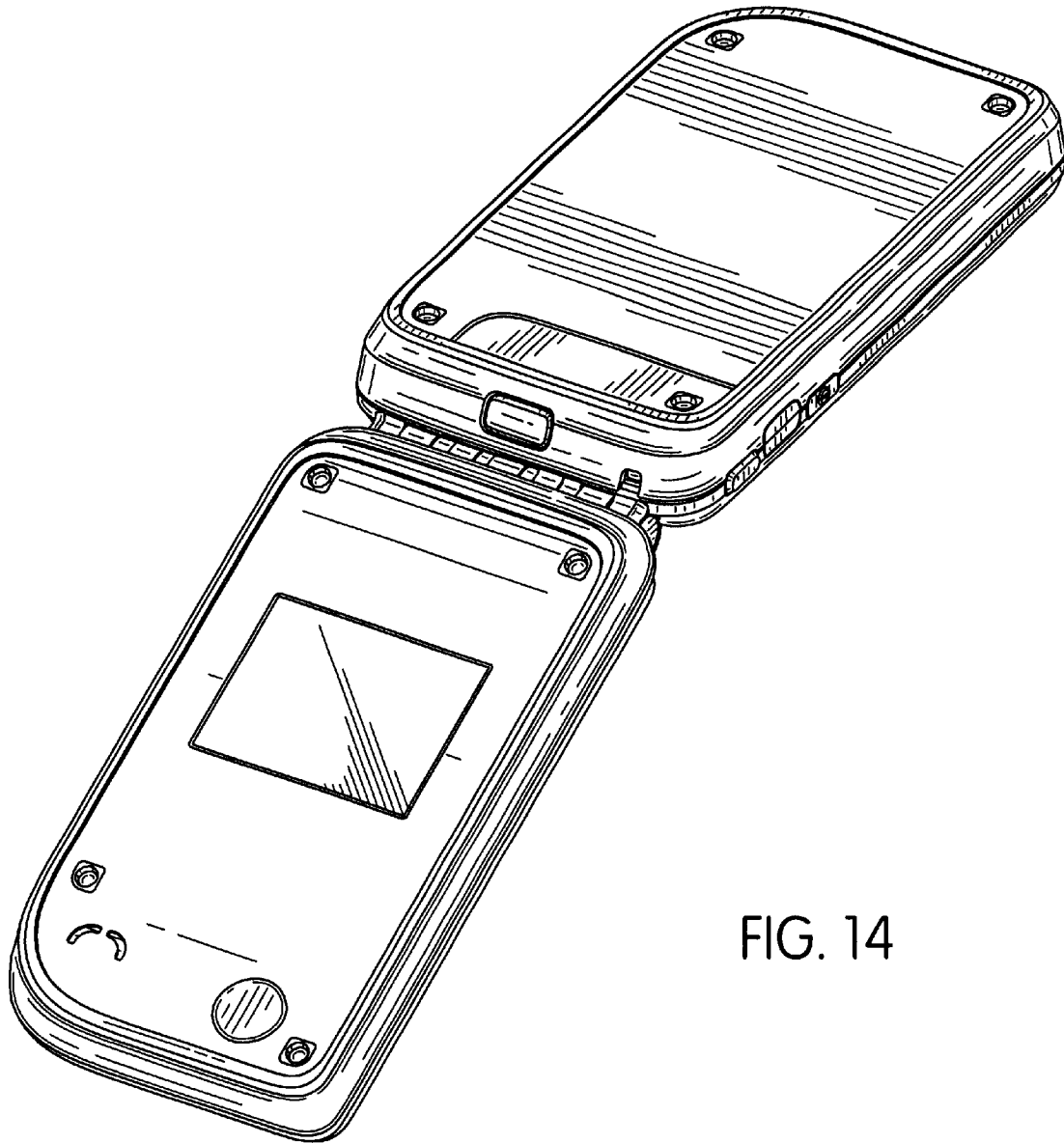

FIG. 14