



US0D1046295S

(12) **United States Design Patent**
Prat-Pfister

(10) **Patent No.:** **US D1,046,295 S**

(45) **Date of Patent:** **** Oct. 8, 2024**

- (54) **HANDLE FOR SHAVER**
- (71) Applicant: **KONINKLIJKE PHILIPS N.V.**,
Eindhoven (NL)
- (72) Inventor: **Gaël Louis Jacques Prat-Pfister**,
Amersfoort (NL)
- (73) Assignee: **KONINKLIJKE PHILIPS N.V.**,
Eindhoven (NL)
- (**) Term: **15 Years**
- (21) Appl. No.: **29/844,454**
- (22) Filed: **Jun. 29, 2022**

D955,045 S *	6/2022	Parambathkandi	
		Abdulahkimm	D28/50
D955,048 S *	6/2022	Van Roosmalen	D28/50
D965,890 S *	10/2022	Prat-Pfister	D28/50
D970,112 S *	11/2022	Van Roosmalen	D28/50
D970,114 S *	11/2022	Prat-Pfister	D28/50
D972,778 S *	12/2022	Li	D28/53
D980,527 S *	3/2023	Prat-Pfister	D28/50
D994,222 S *	8/2023	Van Roosmalen	D28/50

* cited by examiner

Primary Examiner — Alison M Ofstun

Related U.S. Application Data

- (62) Division of application No. 29/738,725, filed on Jun. 19, 2020.

Foreign Application Priority Data

Dec. 19, 2019 (EM) 007434253

(51) **LOC (14) Cl.** **28-03**

(52) **U.S. Cl.**
USPC **D28/50**

Field of Classification Search

USPC D28/49-50, 52-54; D30/158-159
 CPC B26B 19/00; B26B 19/02; B26B 19/06;
 B26B 19/10; B26B 19/20; B26B 19/22;
 B26B 19/28; B26B 19/30; B26B 19/3873;
 B26B 19/3853

See application file for complete search history.

References Cited

U.S. PATENT DOCUMENTS

D932,699 S *	10/2021	Van Roosmalen	D28/50
D942,080 S *	1/2022	Prat-Pfister	D28/50

(57) **CLAIM**

The ornamental design for a handle for shaver, as shown and described.

DESCRIPTION

FIG. 1 is a perspective view showing a first embodiment of a handle for shaver;
 FIG. 2 is a front elevational view thereof;
 FIG. 3 is a rear elevational view thereof;
 FIG. 4 is a right side elevational view thereof;
 FIG. 5 is a left side elevational view thereof;
 FIG. 6 is a top plan view thereof;
 FIG. 7 is a bottom plan view thereof;
 FIG. 8 is a perspective view showing a second embodiment of a handle for shaver;
 FIG. 9 is a front elevational view thereof;
 FIG. 10 is a rear elevational view thereof;
 FIG. 11 is a right side elevational view thereof;
 FIG. 12 is a left side elevational view thereof;
 FIG. 13 is a top plan view thereof; and,
 FIG. 14 is a bottom plan view thereof.

1 Claim, 12 Drawing Sheets

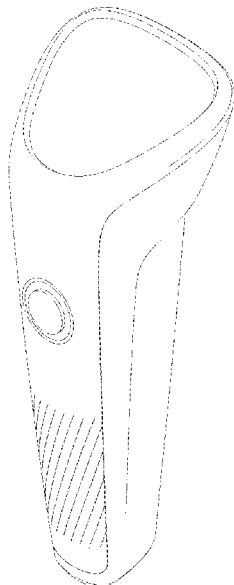

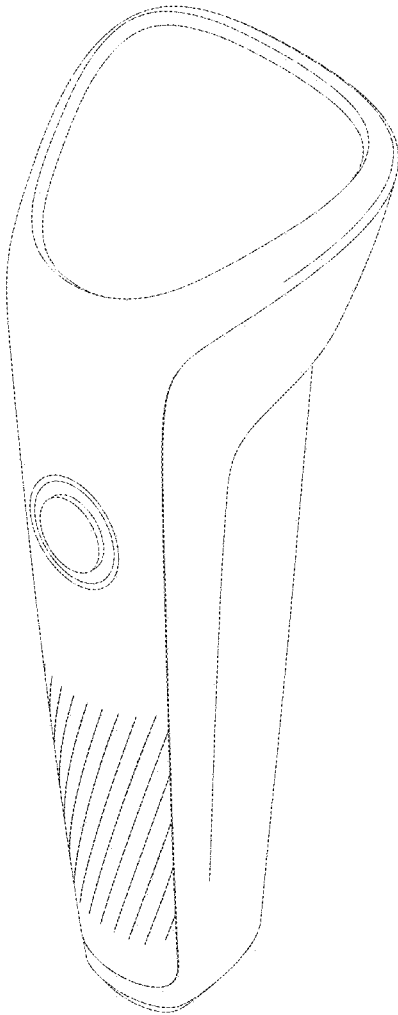

FIG. 1

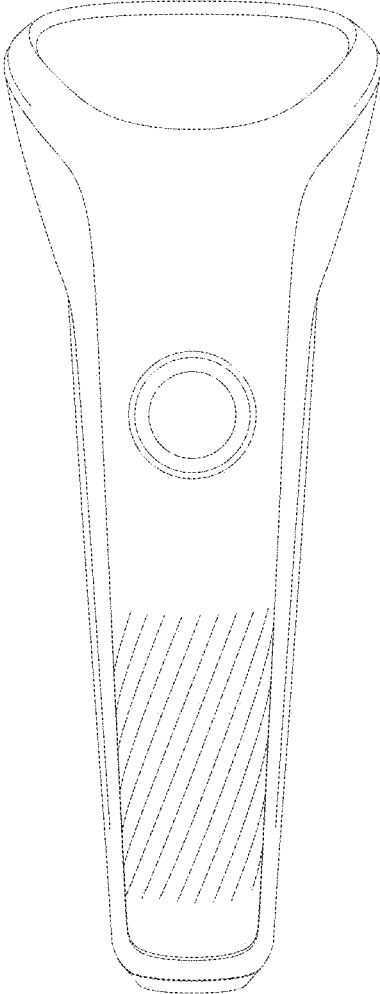

FIG. 2

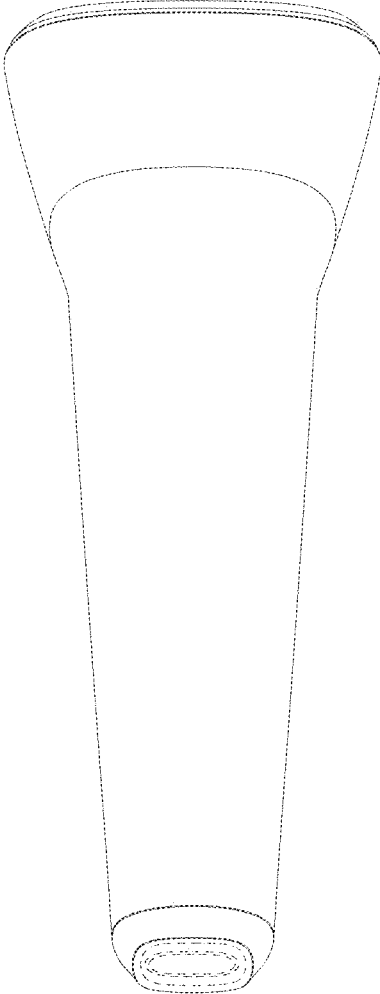

FIG. 3

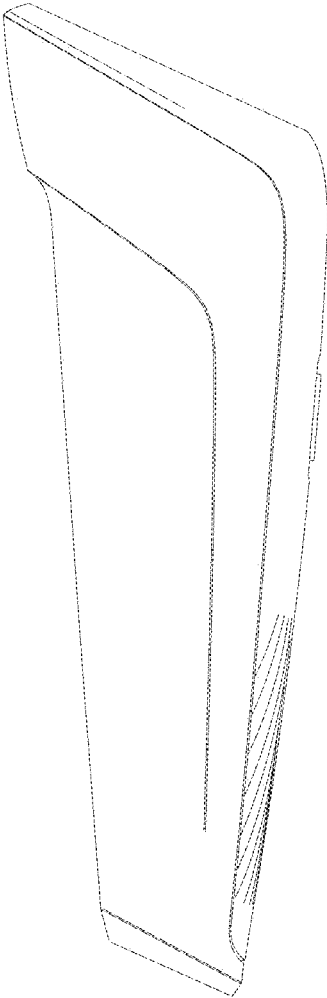

FIG. 4

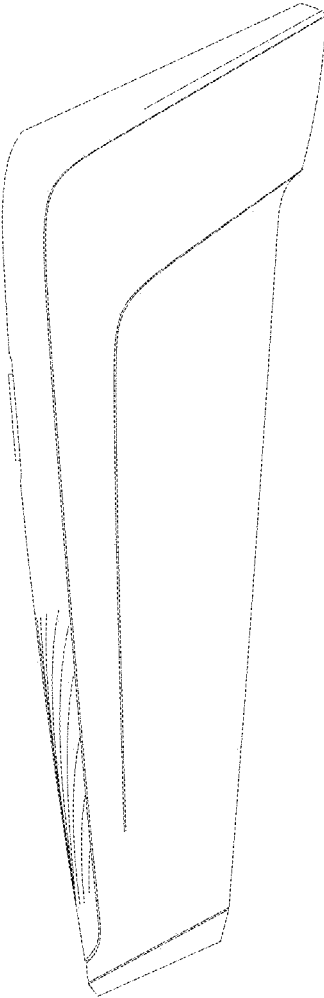

FIG. 5

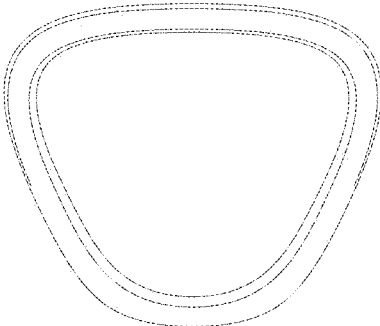

FIG. 6

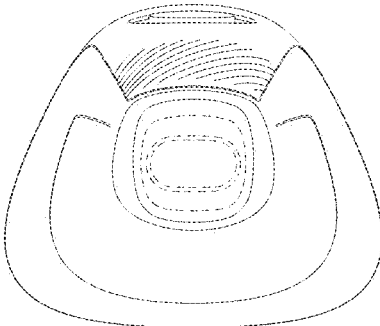

FIG. 7

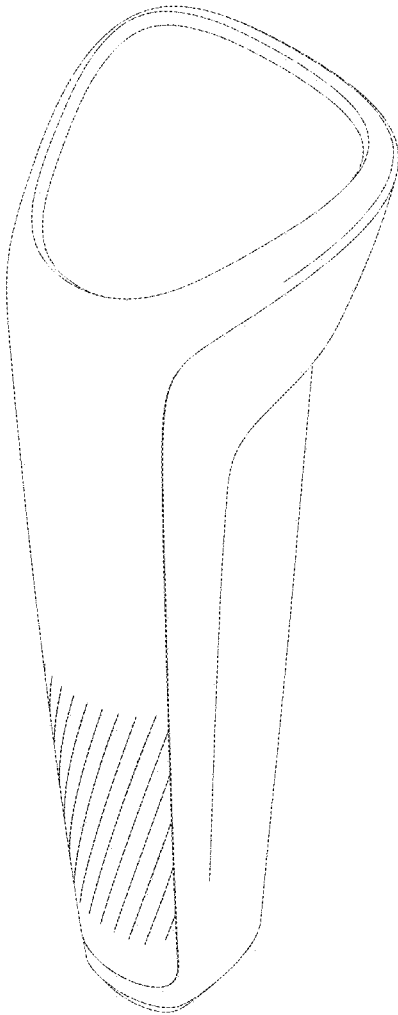

FIG. 8

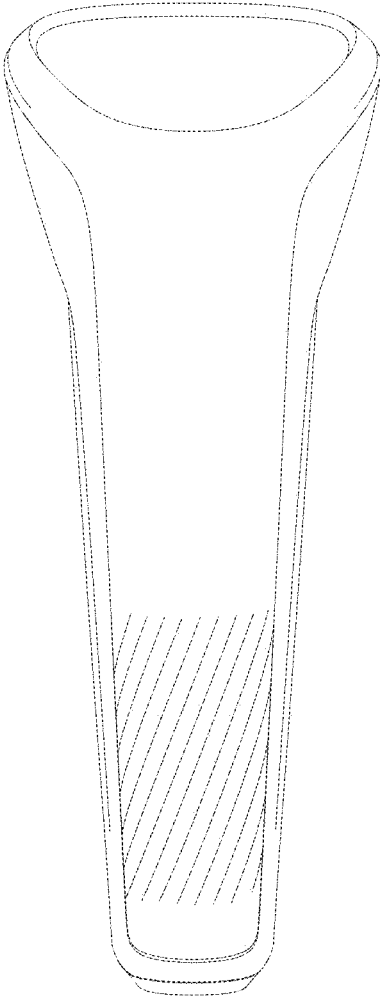

FIG. 9

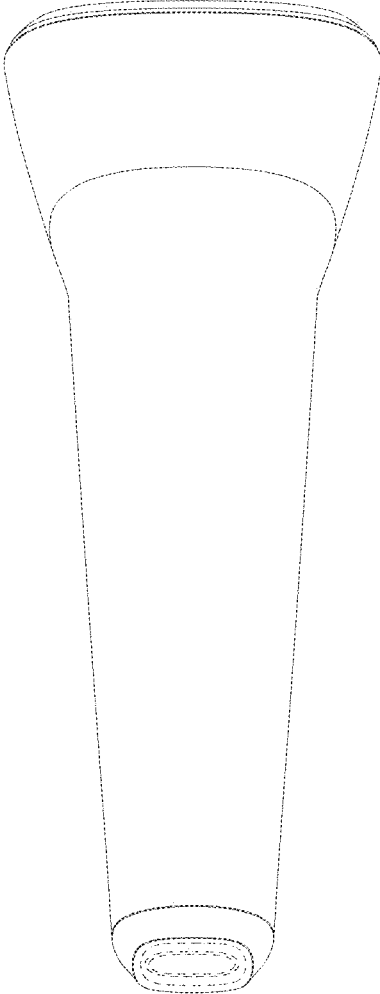

FIG. 10

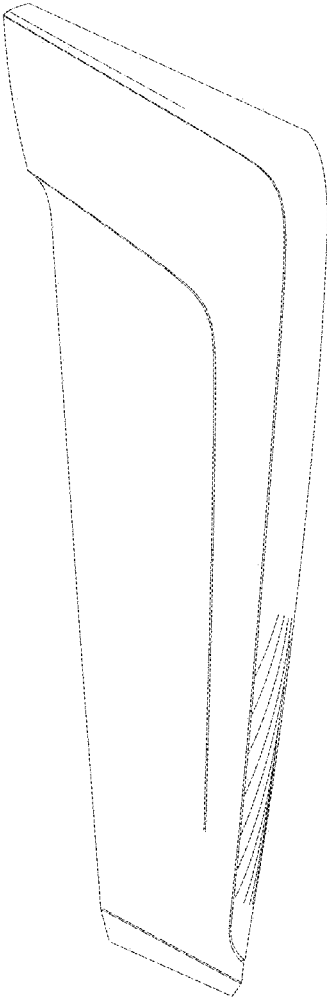

FIG. 11

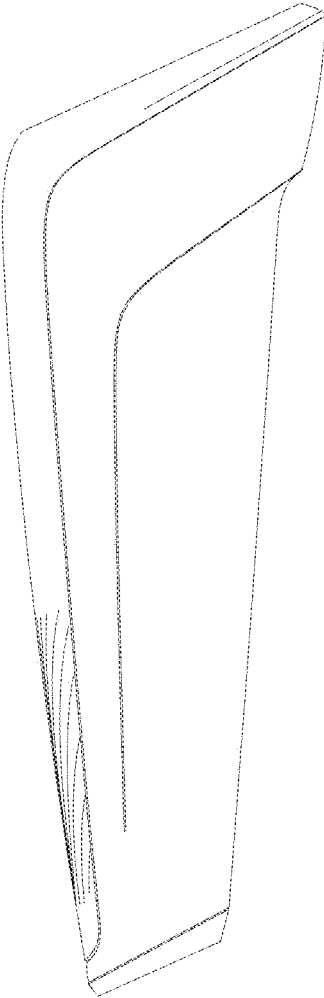

FIG. 12

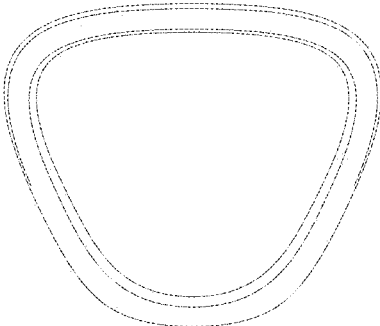

FIG. 13

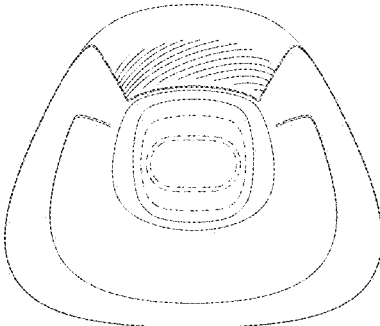

FIG. 14