



US00D376261S

United States Patent [19]

[11] Patent Number: **Des. 376,261**

Haddon

[45] Date of Patent: ****Dec. 10, 1996**

[54] **TOOTH BRUSH WITH REMOVABLE HEAD**

5,033,154 7/1991 Marchand et al. 15/167.1

[76] Inventor: **William C. Haddon**, 730 E. St.,
Springfield, Oreg. 97477

Primary Examiner—A. Hugo Word

Assistant Examiner—Lavone D. Tabor

Attorney, Agent, or Firm—Harold H. Dutton, Jr.; W. Charles
L. Jamison; Diane S. Liebman

[**] Term: **14 Years**

[57] CLAIM

[21] Appl. No.: **29,315**

The ornamental design for a tooth brush with removable
head, as shown.

[22] Filed: **Oct. 3, 1994**

[52] U.S. Cl. **D4/104**; D4/121

[58] **Field of Search** D4/104-112, 121,
D4/130, 133-134, 136, 138; 15/143.1, 145,
159.1, 160, 167.1, 167.2, 176.1, 176.6,
186-187

DESCRIPTION

FIG. 1 is a front view of a tooth brush with removable head
showing my new design;

FIG. 2 is a rear view thereof;

FIG. 3 is a right side view thereof;

FIG. 4 is a left side view thereof;

FIG. 5 is a top plan view thereof; and

FIG. 6 is a bottom plan view thereof; and,

FIG. 7 is an exploded perspective view thereof.

[56] References Cited

U.S. PATENT DOCUMENTS

D. 192,025	1/1962	Rudnick	D4/104
D. 246,080	10/1977	Rallis	D4/104
D. 293,859	1/1988	Gjerde	D4/104
4,683,604	8/1987	Rueb	15/176.1

1 Claim, 4 Drawing Sheets

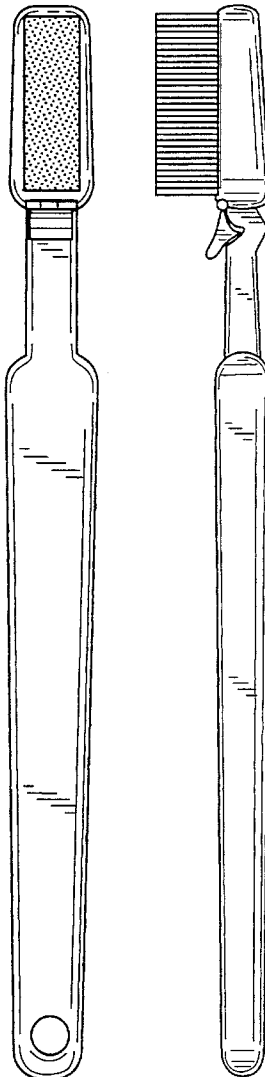

FIG. 1

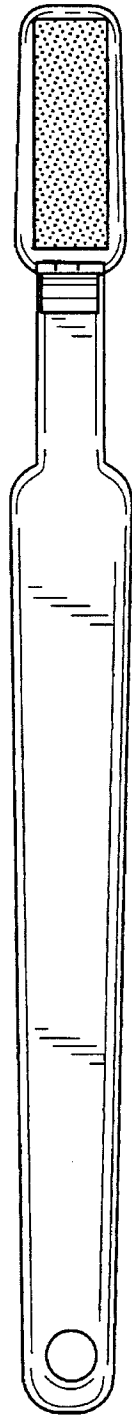

FIG. 2



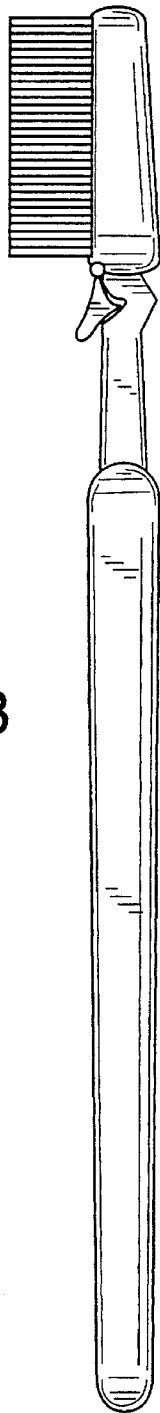

FIG. 3

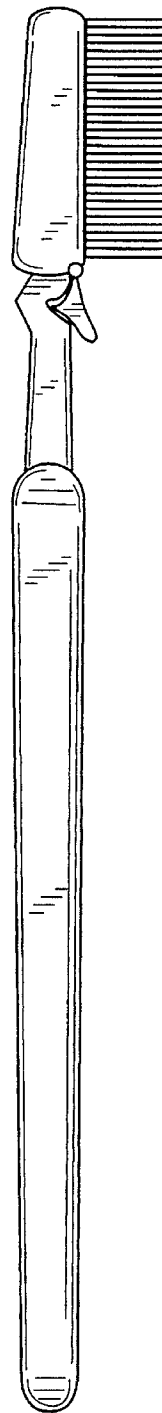

FIG. 4

FIG. 5

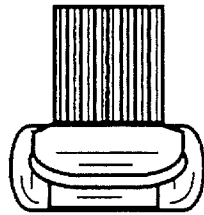
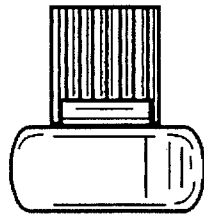

FIG. 6



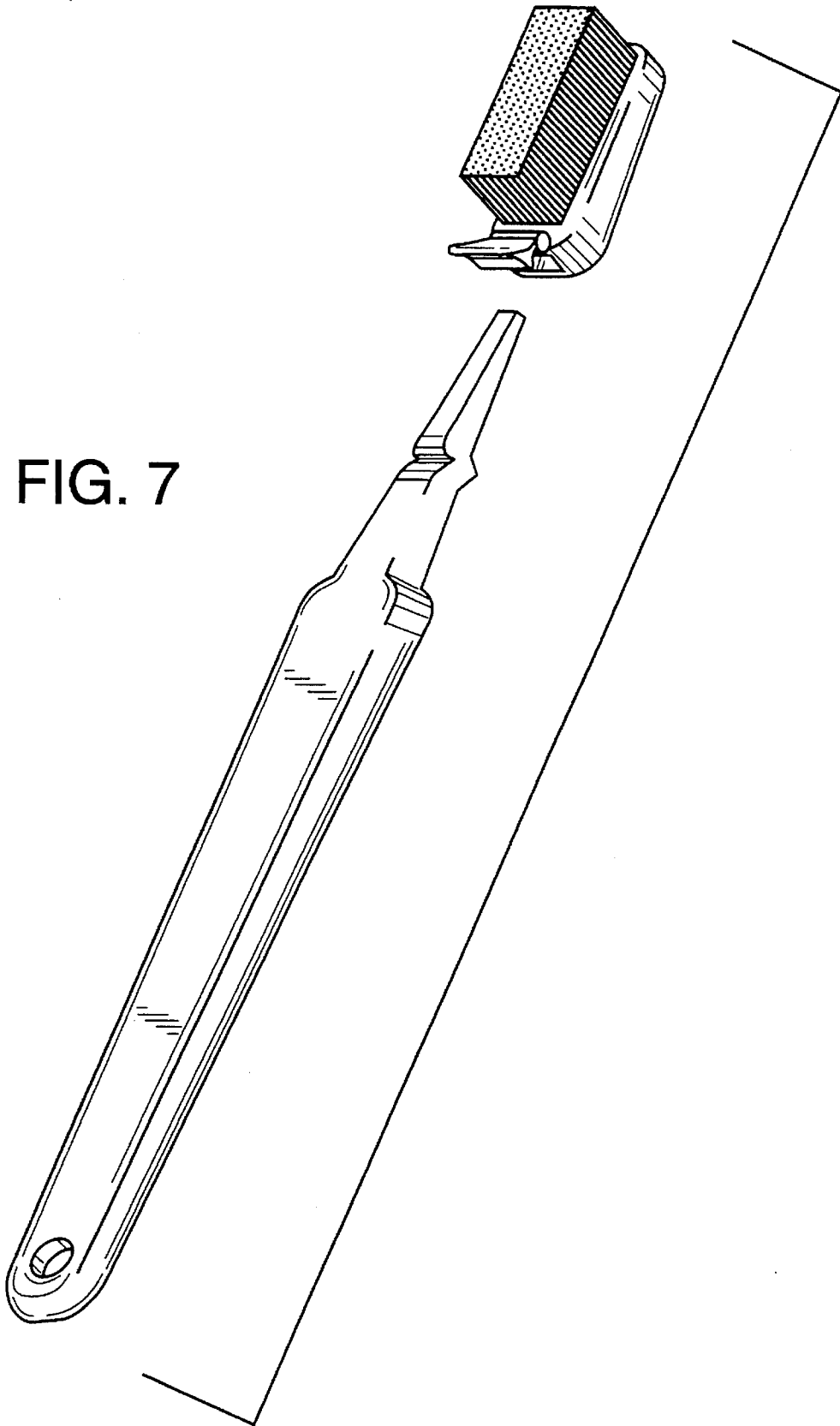

FIG. 7