

(19) World Intellectual Property Organization
International Bureau



(43) International Publication Date
4 May 2006 (04.05.2006)

PCT

(10) International Publication Number
WO 2006/047213 A2

- (51) International Patent Classification:
G01C 21/36 (2006.01)
- (21) International Application Number:
PCT/US2005/037737
- (22) International Filing Date: 20 October 2005 (20.10.2005)
- (25) Filing Language: English
- (26) Publication Language: English
- (30) Priority Data:
10/973,950 25 October 2004 (25.10.2004) US
- (71) Applicant (for all designated States except US): **A9.COM, INC.** [US/US]; 400 Hamilton Avenue, Suite 300, Palo Alto, CA 94301 (US).

GOLD, Jonathan, A. [US/US]; 400 Hamilton Avenue, Suite 300, Palo Alto, CA 94301 (US).

(74) Agent: **LEEK, Shoko, I.**; Christensen O'Connor Johnson Kindness PLLC, 1420 Fifth Avenue, Suite 2800, Seattle, WA 98101 (US).

(81) Designated States (unless otherwise indicated, for every kind of national protection available): AE, AG, AL, AM, AT, AU, AZ, BA, BB, BG, BR, BW, BY, BZ, CA, CH, CN, CO, CR, CU, CZ, DE, DK, DM, DZ, EC, EE, EG, ES, FI, GB, GD, GE, GH, GM, HR, HU, ID, IL, IN, IS, JP, KE, KG, KM, KP, KR, KZ, LC, LK, LR, LS, LT, LU, LV, LY, MA, MD, MG, MK, MN, MW, MX, MZ, NA, NG, NI, NO, NZ, OM, PG, PH, PL, PT, RO, RU, SC, SD, SE, SG, SK, SL, SM, SY, TJ, TM, TN, TR, TT, TZ, UA, UG, US, UZ, VC, VN, YU, ZA, ZM, ZW.

(84) Designated States (unless otherwise indicated, for every kind of regional protection available): ARIPO (BW, GH, GM, KE, LS, MW, MZ, NA, SD, SL, SZ, TZ, UG, ZM, ZW), Eurasian (AM, AZ, BY, KG, KZ, MD, RU, TJ, TM), European (AT, BE, BG, CH, CY, CZ, DE, DK, EE, ES, FI, FR, GB, GR, HU, IE, IS, IT, LT, LU, LV, MC, NL, PL, PT,

[Continued on next page]

- (72) Inventors; and
- (75) Inventors/Applicants (for US only): **MANBER, Udi** [US/US]; 400 Hamilton Avenue, Suite 300, Palo Alto, CA 94301 (US). **DORFMAN, Barnaby, M.** [US/US]; 400 Hamilton Avenue, Suite 300, Palo Alto, CA 94301 (US).

(54) Title: SYSTEM AND METHOD FOR DISPLAYING LOCATION-SPECIFIC IMAGES ON A MOBILE DEVICE

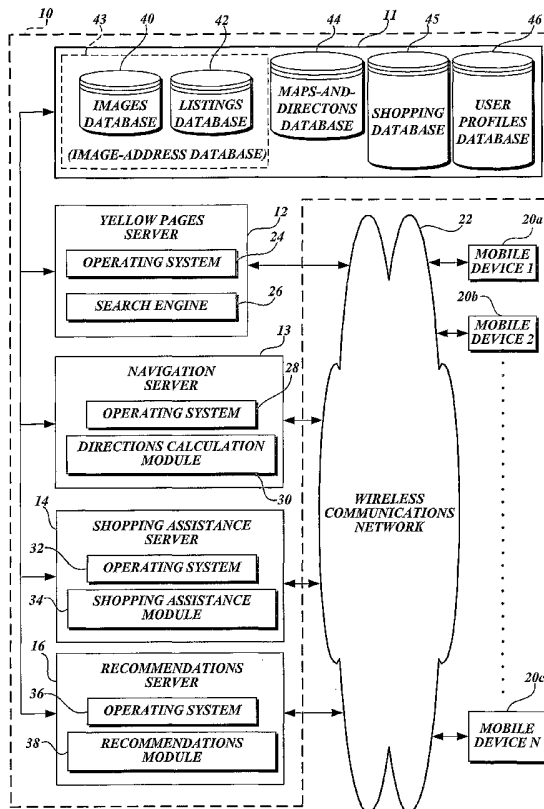

(57) Abstract: A system is provided for providing location-specific images to a mobile device for display. The system generally comprises three components: a mobile device having a screen, a position identification system (e.g., a GPS receiver) that determines the position of the mobile device, and a database containing location-specific images taken at various locations. Each location-specific image is associated with geographic coordinates of the location at which the image was taken. Based on the position of the mobile device as determined by the position identification system, a location-specific image is selected from the database and displayed on the screen of the mobile device. For example, when a user is using the mobile device as a car navigation system, a location-specific image of the user's destination location can be selected and displayed when the determined position of the mobile device comes within a certain distance from the geographic coordinates of the destination location.

WO 2006/047213 A2



RO, SE, SI, SK, TR), OAPI (BF, BJ, CF, CG, CI, CM, GA, GN, GQ, GW, ML, MR, NE, SN, TD, TG).

For two-letter codes and other abbreviations, refer to the "Guidance Notes on Codes and Abbreviations" appearing at the beginning of each regular issue of the PCT Gazette.

Published:

— *without international search report and to be republished upon receipt of that report*

SYSTEM AND METHOD FOR DISPLAYING LOCATION-SPECIFIC IMAGES ON A MOBILE DEVICE

FIELD OF THE INVENTION

5 The present invention is related to providing location-specific services to mobile devices, and more specifically, to displaying a location-specific image on a mobile device based on a determined position of the mobile device.

BACKGROUND OF THE INVENTION

10 Various types of mobile devices are available to transmit/receive various information wirelessly, such as cellular phones, personal digital assistants (PDAs), Blackberry[®] devices, etc. These devices can store and process an increasing amount of information, including real-time images in the form of a video clip. Many of these devices include a color screen that can display images (graphics) as well as text. Further, some of these devices are equipped with a global positioning system (GPS) receiver so as
15 to function as a navigation system, in addition to functioning as a communications device. As is well known in the art, a navigation system can receive a destination location from a user, calculate suitable directions to go from the user's current position, as determined based on data obtained by the GPS receiver, to the destination location, and display the directions together with a relevant map on its screen. The directions and a
20 map as displayed on the screen are constantly updated based on the current (moving) position of the user as determined based on data obtained by the GPS receiver. Current navigation systems, however, do not display a ground-level image of the destination location (i.e., an image taken at the destination location), or any other images of locations that the user will pass along the way toward the destination location. A ground-level
25 image, as used herein, means an image that shows an object (e.g., a business storefront) in the manner actually perceived by people on the ground, as opposed to aerial or rooftop images. It would be helpful for the user to be able to view such images on the screen of the navigation system so that the user can look for particular objects (e.g., buildings, intersections, etc.) shown in the images of the destination location and any other
30 landmark points along the directions, especially when traveling in an unfamiliar area. More particularly, what is lacking is a system and method for displaying location-specific images (i.e., ground-level images of objects taken at particular locations) on a mobile

device, such as a cellular phone and a car navigation system, based on the determined position of the mobile device.

SUMMARY OF THE INVENTION

The present invention provides methods and systems whereby a mobile device, such as a cellular phone or a car navigation system, may display location-specific images based on the position of the mobile device as determined by a position identification system, such as a GPS system. To that end, a database of location-specific images is provided, wherein each image is associated with the geographic coordinates (e.g., longitude/latitude coordinates) of the location at which the image was taken. In various exemplary embodiments of the present invention, each image associated with its geographic coordinates is further correlated with its street address (or its business name, for example) so that the image can be retrieved and displayed based on a user input of its street address (or business name, etc.) The construction and use of such a database are disclosed in detail in co-pending U.S. Patent Application No. 10/809,049, filed March 24, 2004, which is explicitly incorporated herein by reference.

Thus, for example, a user of a car navigation system will be able to enter a destination location using its street address, and the method and system of the present invention will permit the car navigation system to display the image of the destination location and additional images of other landmark points along the way toward the destination location in addition to the usual maps-and-directions to the destination location. The timing at which each of these location-specific images is to be displayed will depend on the current position of the car navigation system as determined by its position identification system (e.g., GPS system). In one example, an image of a landmark point will be displayed when the car navigation system comes within a certain distance from the landmark point with an appropriate text message, such as "Look for this, and turn left at this." Likewise, an image of the final destination location may be displayed when the car navigation system comes within a certain distance from the destination location, or whenever the user requests to view such an image, with an appropriate text message, such as "Look for this at your destination." Timely display of these location-specific images will assist the user in following the directions and finding the final destination location easily. Further, the image of a destination location may be displayed at the beginning (prior to starting the user's journey to the destination location) so as to assist the user in deciding whether or not to go there (e.g., based on how

appealing the image of the destination location looks to the user), remembering whether the user has been there before, etc.

In one embodiment, the location-specific images are provided to a mobile device through a wireless communications network from a centralized database. In another
5 embodiment, the location-specific images may be pre-stored in the mobile device via a hard disk (including DVD, CD, etc.).

In one application, instead of discrete images, a video clip that displays a moving view of an entire trip or a part thereof can be downloaded (or pre-stored) and displayed on a mobile device.

10 In a further application, the location-specific images (including video images) may be transferred not only from a centralized database to mobile devices, but also from the mobile devices to the database. For example, if a mobile device, such as a cellular phone, has an image capturing capability, the user of the mobile device can take an image at a particular position, and the image can be automatically coded with the geographic
15 coordinates of the position of the mobile device when the image is taken as determined by the position identification system (e.g., GPS receiver), and then the geo-coded image can be transferred from the mobile device to the database so as to continuously update and/or expand the database.

Generally, in accordance with various exemplary embodiments of the present
20 invention, a system is provided for providing location-specific images to a mobile device for display. The system is generally comprised of three components: a mobile device having a screen, a position identification system (e.g., a GPS receiver) that determines the position of the mobile device, and a location-specific images database including images taken at various locations, wherein each image is associated with geographic coordinates
25 of the location at which the image was taken. The position of the mobile device is identified by the mobile device position identification system, and a location-specific image is selected from the database based on the determined position of the mobile device and displayed on the screen of the mobile device. For example, the location-specific image is selected when the determined position of the mobile device
30 comes within a certain distance from the geographic coordinates associated with the image.

The system may be adapted to selectively display location-specific images on a mobile device in various contexts. For example, the system may be applied to provide

shopping assistance to a user of the mobile device. In this application, the system receives at the mobile device a shopping list from the user including one or more items that the user wishes to purchase. For each of the items in the shopping list, the system identifies one or more businesses that carry the item. Then, for each of the one or more
5 identified businesses, the system determines its geographic coordinates and further identifies its corresponding location-specific image. Finally, the system generates a shopping list program comprising instructions for displaying on the screen of the mobile device an image of one of the one or more identified businesses based on the determined position of the mobile device. For example, the system may display a location-specific
10 image of a particular business that carries an item included in the user's shopping list when the business is determined to be within a certain distance from the determined position of the mobile device. An audio alarm may be issued when the image is displayed to further alert the user that the relevant business is near.

As another example, the system may be applied to recommend "favorite" places to
15 visit to a user of the mobile device. In this application, the system, upon receiving from the mobile device a user's request for a recommendations service, accesses a profile of the user of the mobile device in a user profiles database to identify one or more favorite places of the user. The favorite places may be those places that the user has previously explicitly entered as his/her favorites, or may be presumed based on the user's past
20 behavior on the system, for example, destination locations that the user has previously entered in a navigation service. The system then determines geographic coordinates of the one or more favorite places. Finally, the system generates a favorite places program comprising instructions for displaying on the screen of the mobile device an image of any of the one or more favorite places based on the determined position of the mobile device.
25 For example, the system may display a location-specific image of a particular favorite place of the user when the favorite place is determined to be within a certain distance from the determined position of the mobile device.

In accordance with a further aspect, the present invention provides a method of displaying a location-specific image on a mobile device based on the position of the
30 mobile device. The method generally includes three steps. First, a position of a mobile device is received. Second, a location-specific image is selected from multiple location-specific images based on the received position of the mobile device, wherein

each location-specific image is associated with geographic coordinates of the location at which the image was taken. Third, the selected image is displayed on the mobile device.

In accordance with a still further aspect, the present invention provides a mobile device capable of displaying a location-specific image based on a determined position of the mobile device. The mobile device generally consists of two elements: a screen and a processor. The processor is loaded with processor-executable instructions for generally performing three steps. The first step involves receiving a position of the mobile device as determined by a position identification system. The second step involves selecting a location-specific image from a set of location specific images based on the determined position of the mobile device. The third step involves displaying the selected location-specific image on the screen. In an application wherein the set of images is stored in an images database external to the mobile device, a location-specific image is selected from the database based on the determined position of the mobile device, and is transmitted over a wireless communications network to the mobile device for display. In another application wherein the set of images is stored in a memory of the mobile device, a location specific image is selected from the memory based on the determined position of the mobile device and displayed on the screen.

BRIEF DESCRIPTION OF THE DRAWINGS

The foregoing aspects and many of the attendant advantages of this invention will become more readily appreciated as the same become better understood by reference to the following detailed description, when taken in conjunction with the accompanying drawings, wherein:

FIGURE 1A is a block diagram showing an environment and arrangement of certain computing components for implementing a mobile image service according to one embodiment of the present invention;

FIGURE 1B is a diagram illustrating an exemplary configuration of a mobile device, suitable for use in receiving the mobile image service in accordance with one embodiment of the present invention;

FIGURE 1C is a pictorial diagram illustrating two-way transfer of location-specific images between an images database and one or more mobile devices through a network as implemented in various exemplary embodiments of the present invention;

FIGURE 2 is a flow diagram of one exemplary method for generating a navigation program which upon execution will display one or more location-specific images based on the determined position of a mobile device according to one embodiment of the present invention;

5 FIGURE 3 is a flow diagram illustrating the execution of the navigation program generated in accordance with FIGURE 2 above according to one embodiment of the present invention;

10 FIGURE 4 is a flow diagram of one exemplary method of generating a shopping program which, upon execution, will display one or more location-specific images based on the determined position of a mobile device according to one embodiment of the present invention;

 FIGURE 5 is a flow diagram illustrating the execution of the shopping program generated in accordance with FIGURE 4 above according to one embodiment of the present invention;

15 FIGURE 6 is a flow diagram of one exemplary method of generating a favorite places program which, upon execution, will display one or more location-specific images based on the determined position of a mobile device according to one embodiment of the present invention;

20 FIGURE 7 is a flow diagram illustrating the execution of the favorite places program generated in accordance with FIGURE 6 above according to one embodiment of the present invention;

 FIGURE 8 is a sample screen shot that can be displayed on a mobile device during the execution of a navigation program in accordance with one embodiment of the present invention;

25 FIGURE 9 is a sample screen shot that can be displayed on a mobile device during the execution of a shopping program in accordance with one embodiment of the present invention; and

30 FIGURE 10 is a sample screen shot that can be displayed on a mobile device during the execution of a favorite places program in accordance with one embodiment of the present invention.

DETAILED DESCRIPTION OF THE PREFERRED EMBODIMENTS

The present invention is directed to a system and method for providing a mobile image service. The mobile image service, as used herein, refers to one or more services

that provide and display location-specific images on a mobile device based on the determined position of the mobile device. A location-specific image, as used herein, refers to an image taken at a location, and is thus associated with the geographic coordinates (e.g., longitude/latitude coordinates) of the location at which the image was taken. In various exemplary embodiments, location-specific images are ground-level location-specific images that show objects as generally perceived by people on the ground, as opposed to aerial or rooftop images. The following detailed description provides several exemplary implementations of the mobile image service. Although specific system configurations and flow diagrams are illustrated, it should be understood that the examples provided are not exhaustive and do not limit the invention to the precise forms disclosed. Persons having ordinary skill in the field of digital data processing will recognize that the computer components and the arrangements described herein may be interchangeable with other components and arrangements, and further that the process steps described herein may be interchangeable with other steps or combinations thereof and still achieve the benefits and advantages of the present invention.

FIGURE 1A illustrates an exemplary overall environment for implementing a mobile image service, which includes a mobile image system 10 including various servers (a database server 11, a Yellow Pages server 12, a navigation server 13, a shopping assistance server 14, and a recommendations server 16) for supporting the mobile image service and one or more mobile devices 20a, 20b, and 20c (collectively referred to as "the mobile devices 20"). The mobile image system 10 resides on a network, such as the Internet, and the mobile image system 10 and the mobile devices 20 are connected with each other via any suitable wireless communications network 22, such as an Internet-enabled wireless communications network that provides the mobile devices 20 with wireless access to the mobile image service available from the mobile image system 10.

The wireless communications network 22 utilizes any one of a variety of wireless communications mediums and/or communication methods to transfer data. Examples of suitable wireless communications mediums/methods include, but are not limited to, wireless telephony, personal communications service (PCS), short message service (SMS), wireless application protocol (WAP), IEEE 802.XX wireless LAN (WLAN) including a Wireless-Fidelity (Wi-Fi) and Wi-Max networks, two-way paging networks, specialized mobile radio systems, non-licensed personal area network (PAN) technology,

such as the Bluetooth protocol, and infrared links. Further, the wireless communications network 22 may employ Internet Protocol (IP) addressing. Accordingly, the mobile devices 20 can be any devices that communicate with the chosen wireless communications network 22, such as cellular phones, personal digital assistants (PDAs), mobile computer communicators, such as Blackberry[®] devices, etc., to be fully described in reference to FIGURE 1B below. The wireless communications network 22 may also include a network that is in part a wired network. For example, the servers 11, 12, 13, 14, and 16 of the mobile image system 10 may be interconnected on a wired network with which the mobile devices 20 interface wirelessly.

10 In one embodiment, the mobile devices 20 communicate with the mobile image system 10 via the wireless communications network 22 using IP addressing. Protocols and components for communicating wirelessly to and from the Internet are well known to those of ordinary skill in the art of computer network communications. Generally, each of the mobile devices 20 may execute any suitable user interface (UI) application (not shown) that understands given protocols for communicating with the mobile image system 10 via the network 22. Examples of suitable UI applications include, but are not limited to, a Web browser application, .NET[™] application, JAVA[®] application, such as J2EE[®] application, Pocket Outlook[™] application, any custom-designed standalone UI application, etc. Each of these UI applications permits a user of the mobile device 20 to download, upload, display, or otherwise access resources and services available from the mobile image system 10 and, in particular, provides the user with a graphical user interface (GUI) to the mobile image system 10. The mobile image system 10 as depicted in FIGURE 1A operates in a distributed computing environment comprising several computer systems that are interconnected by communication links, e.g., using one or more computer networks or direct connections. However, it will be appreciated by those of ordinary skill in the art that the system 10 could equally operate in a computer system having fewer or greater number of components than are illustrated in FIGURE 1A. For example, each of the servers depicted in FIGURE 1A may be implemented using a greater number of computing systems so that each of the various services (collectively referred to as the "mobile image service") provided by the mobile image system 10 may be performed by a cluster of different computing devices. As another example, components of the mobile image system 10 and the mobile device 20 may be reduced to a single computer system (i.e., embedded in the mobile device 20), as will be more fully

described below. Therefore, the description of the mobile image system 10 in FIGURE 1A should be taken as exemplary, and not limiting the scope of the invention.

The illustrated embodiment of the mobile image system 10 includes a database server 11, a Yellow Pages server 12, a navigation server 13, a shopping assistance server 14, and a recommendations server 16. The database server 11 includes various databases, such as an images database 40, listings database 42, maps-and-directions database 44, shopping database 45, and user profiles database 46. These databases contain various data to be used by the servers of the mobile image system 10, as will be fully described below.

The Yellow Pages server 12 includes an operating system 24 and a search engine 26. The details of the Yellow Pages server 12, together with construction of the images database 40 and the listing database 42, are described in U.S. Patent Application No. 10/809,049, incorporated above. Briefly, the Yellow Pages server 12 is a Web page server that supports an online Yellow Pages Web site, at which each listing (e.g., business) can be displayed together with an image of the listing (e.g., an image of the business storefront). The Yellow Pages server 12 communicates text and graphics organized as a Web page using, for example, hypertext transfer protocols, in response to requests and search queries received from any of the mobile devices 20. It should be noted that while the present description is provided in the context of an online business directory (e.g., Yellow Pages) at which each business listing is associated with an image of its geographic location, the same concept can be applied to create and publish online residential directories (e.g., White Pages) in which each individual listing is associated with an image of its geographic location (e.g., an image of a house). Therefore, the term "Yellow Pages" as used herein may refer to other types of directories as well, including White Pages.

The listings and their associated location-specific images, which are processed by the Yellow pages server 12, are stored in the listings database 42 and the images database 40, respectively, within the database server 11, in accordance with one embodiment of the present invention. It should be understood by those skilled in the art that a particular configuration of the databases is not limited to what is disclosed in FIGURE 1A, and the databases shown to be included in the database server 11 may be arranged in a distributed manner or may be consolidated into a fewer number of databases, etc. The listings database 42 stores information generally found in conventional Yellow Pages in a

searchable form, e.g., listings (business names together with their addresses, phone numbers, etc.) searchable by their business names, addresses, phone numbers, business types, etc. The listings database 42 may further store each listing in association with its geographic coordinates (e.g., longitude/latitude coordinates). As used herein, geographic
5 coordinates refer to various types of geographic identifiers used in suitable position-identification systems, including the two axes-based global coordinates system (i.e., longitude/latitude coordinates), a two axes-based local or customized coordinates system, or any other addressing system that uniquely identifies a geographic location. The images database 40 contains digitized images of the business listings taken at their
10 geographic locations in association with their geographic coordinates. Thus, between the images database 40 and the listings database 42, each image is associated with its geographic coordinates and is further correlated with its street address. A combination of the images database 40 and the listings database 42 is therefore referred to as an image-address database 43.

15 In operation, upon receiving a search request from users of the mobile devices 20, the Yellow Pages Server 12 conducts a searches of the listings database 42 and the images database 40, and identifies and transmits appropriate listings together with their images over the network 22 to the requesting mobile devices 20 for display. The administration and overall operation of the Yellow Pages server 12 is controlled by its
20 operating systems 24, while its search function is performed by the search engine 26 in cooperation with the image-address database 43. The image-address database 43 is configured to receive search instructions from the search engine 26 and to return search results thereto. Those of ordinary skill in the art will recognize that the Yellow Pages server 12 and the image-address database 43 will each typically employ a memory and
25 main processor in which program instructions are stored and executed for their operation. In combination, the Yellow Pages server 12 and the image-address database 43 permit users of the mobile devices 20 to search and view online Yellow Pages in which each listing (e.g., business) is displayed with an image of an object (e.g., business building) taken at its geographic location. Since each image is correlated with its street address in
30 the image-address database 43, the users can search for and view an image of a business based on its street address (or based on any other data associated with the business listing in the listings database 42).

FIGURE 1B illustrates an exemplary configuration of a mobile device 20 suitable for use in the present invention. In various exemplary embodiments of the present invention, a mobile device 20 may be any device that communicates with a chosen wireless communications network 22, such as cellular phones, personal digital assistants (PDAs), mobile computer communicators, such as Blackberry[®] devices, portable (mobile) computers, such as laptop computers, Webpads, tablets, and other computing devices having some type of memory, etc. In the illustrated embodiment, the mobile device 20 includes a processor 50 in communication with an input/output interface 52, a memory 54, and a network interface 56 for interfacing with the wireless communications network 22. The input/output interface 52 enables the processor 50 to communicate with various input and output devices. Input devices 58 may include any computing elements that provide input signals to the processor 50, such as a keyboard, a mouse, a speech recognition application, such as Microsoft[®] Speech.NET[™] application, etc. Output devices 60 may include typical output devices, in particular a screen display. The processor 50 is configured to operate in accordance with computer program instructions stored in a memory, such as the memory 54. Program instructions may also be embodied in the hardware format, such as one or more programmed digital signal processors. In one application, location-specific images are stored in the images database 40 of the mobile image system 10 (see FIGURE 1A) and transmitted over the wireless communications network 22 to be received by the mobile device 20 for display on its screen 60. In another application, a set of location-specific images, for example, a set of location-specific images corresponding to the general area of interest to the user, may be transmitted over the wireless communications network 22 to be pre-stored in the memory 54 (for example, a hard drive) of the mobile device 20, and the pre-stored images can then be retrieved and displayed on the screen 60.

In a further application, location-specific images may be pre-stored in a hard disk (including DVD, CD, etc.), such as in a Yellow Pages hard disk 62, a navigation hard disk 64, and a shopping assistance hard disk 66, and may be loaded onto the memory 54 of the mobile device 20. Essentially, the images to be displayed on the mobile device 20, together with their associated computer instructions, for use in providing the Yellow Pages service, the navigation service, and the shopping assistance service, respectively, may be stored in these disks. These hard disks are received by a disk drive (forming part of the memory 54) of the mobile device 20 for storage. For example, the mobile

device 20 may be a car navigation system without a wireless communications capability to which different sets of location-specific images in the form of different hard disks can be loaded depending on the particular general area of interest to the user. In this application, it is not necessary for the mobile device 20 to retrieve location-specific
5 images from the images database 40 of the mobile image system 10 over the wireless communications network 22.

In various exemplary embodiments of the present invention, the functionality provided by the mobile image system 10 is best described in terms of services. The present invention offers various mobile image services, in each of which a mobile
10 device 20 displays a location-specific image that is selected based on the determined position of the mobile device 20. These services may be provided by the servers, each of which is depicted as a single computing device for ease of illustration in FIGURE 1A, or may be provided by a greater number of computing devices than shown in FIGURE 1A. As known to those skilled in the art, any stand-alone server may be supported by multiple
15 computer systems connected together by a local area network or other communication mechanism. As another example, the services may be provided by the mobile device 20 itself when it locally stores all necessary data and instructions (program code) in its memory device, as described above. Accordingly, it should be understood that the term "mobile image system" as used herein encompasses various hardware configurations for
20 implementing the mobile image services of the present invention, and is not limited to the particular configuration depicted in FIGURE 1A.

In accordance with the present invention, a location-specific image to be displayed on the screen 60 of the mobile device 20 is selected based on the position of the mobile device 20 as determined by a position identification system. In the present
25 description, the term "position identification system" is used to refer to any system that is capable of identifying the geographic position of the mobile device 20 so as to permit selection of location-specific images for display based on the determined position. The position identification system may utilize device-based technologies, i.e., technologies that permit the mobile device 20 to self-identify its position. An example of using such
30 technologies is to equip the mobile device 20 with a global positioning system (GPS) receiver 68, as shown in FIGURE 1B. Alternatively, the position identification system may utilize network-based technologies, wherein the position of the mobile device 20 is identified based on a communication link connecting the mobile device 20 and the mobile

image system 10 over the wireless communications network 22 (see FIGURE 1A). For example, certain cellular phone systems track the strength, the angle, and the arrival time difference of transmission signals for determining a cell phone's position, using time difference of arrival (TDOA) technology or timing advance (TA) location measurement technology. In this embodiment, the position of the mobile device 20 is identified by the overall wireless communications network 22, perhaps at its base station (not shown), and the identified position may be relayed to the mobile device 20 and/or the mobile image system 10 to select suitable location-specific images for display based on the identified position of the mobile device 20. Further alternatively, the position identification system may utilize a combination of both device-based technologies and network-based technologies.

A variety of position identification systems, utilizing device-based technologies and/or network-based technologies, are under development and/or available, as is well known in the art. When the mobile device 20 consists of a cellular phone, the position identification system may be in compliance with the wireless Enhanced 911 standard prescribed by the United States Federal Communications Commission ("the wireless E911 standard"). The wireless E911 standard mandates that cellular phone service providers within the United States provide the capability to locate the position of a cellular phone making an emergency (911) call within the provider's system. Other position identification systems may be in compliance with similar standards prescribed in other countries. It should be noted that a position identification system in accordance with the present invention is capable of identifying the position of the mobile device (e.g., a cellular phone) with respect to any "calls" placed to any numbers, IP addresses, etc., and is not limited to emergency calls.

Therefore, the determination of the position of the mobile device 20 may or may not be performed by the mobile device 20 itself. Specifically, if a particular embodiment of a position identification system is such that the mobile device 20 is configured to self-identify its position (e.g., using a GPS receiver), then the mobile device 20 is equipped with such a position identification system, and the position identification system, perhaps in conjunction with the processor 50 of the mobile device 20, will determine the position of the mobile device 20. The mobile device 20 (or, more specifically, its processor 50) will then carry out suitable instructions to select location-specific images for display based on the determined position of the mobile

device 20. On the other hand, in another embodiment of the position identification system, the position of the mobile device 20 may be determined by the overall wireless communications network 22 (e.g., using TDOA technology) without having the mobile device 20 perform any particular functions other than being turned on and transmitting/receiving signals to/from the network 22. In such a case, the determined position of the mobile device 20 may or may not be relayed to the mobile device 20, and selection of suitable location-specific images based on the determined location of the mobile device 20 may be performed by the mobile device 20 and/or the mobile image system 10.

10 Those having ordinary skill in the art of computers will recognize that a wide selection of commercially available components and arrangements can be used to construct a system, such as the mobile device system 20 illustrated in FIGURE 1B.

FIGURE 1C illustrates two-way transfer of location-specific images between the images database 40 of the mobile image system 10 and the mobile device 20 over the wireless communications network 22. When the mobile device 20 has an image capturing capability (e.g., including a digital camera 69 as shown in FIGURE 1B), the processor 50 of the mobile device 20 may associate the captured image with the position of the mobile device 20 at the time the image was taken (as determined by any suitable position identification system, described above) to produce a location-specific image (i.e., an image associated with the geographic coordinates of the location at which the image was taken). The location-specific image can then be transmitted over the wireless communications network 22 to be included in the images database 40 within the mobile image system 10. Thus, the images database 40 can be constantly updated and/or expanded by receiving additional location-specific images uploaded from the mobile devices 20. For example, when a location-specific image associated with particular geographic coordinates is of poor quality (blurred, partially hidden by an obstructing object such as a passing pedestrian, etc.), a user of the mobile device 20 can take a high-quality image at the same location and upload the image to replace the poor-quality image. As further examples, a user of the mobile device 20 can upload a location-specific image for the purpose of receiving a specific service. As a specific example, when a user is locked out of a car, house, etc., the user can take an image of his location including the car, house, etc, and send the location-specific image via the wireless communications network 22 to a locksmith whose computing device has a

display. The location-specific image sent by the user will be displayed on the computing device of the locksmith, together with its associated address, so that the locksmith can readily determine and reach the location of the user.

Referring back to FIGURE 1A, the mobile image system 10 may further include the navigation server 13, including an operating system 28 and a directions calculation module 30. The navigation server 13, in conjunction with the image-address database 43 and the maps-and-directions database 44 in the database server 11, provide and display location-specific images on the mobile device 20 as part of a navigation program based on the determined position of the mobile device 20. In particular, the navigation server 13 generates a navigation program which, when executed on the mobile device 20, will display not only the relevant maps-and-directions to a destination location, but also various location-specific images of the destination location and any landmark points along the way. The administration and overall operation of the navigation server 13 is controlled by its operating system 28, while its function for calculating directions and generating a directions program is performed by the directions calculation module 30 in cooperation with the maps-and-directions database 44, the images database 40, and the listings database 42, for example.

FIGURE 2 illustrates a sample routine 200 to be performed by the directions calculation module 30 to generate a navigation program that incorporates various location-specific images to be displayed on the mobile device. At block 201, the directions calculation module 30 receives a request for a navigation service from a mobile device 20. At block 202, the directions calculation module 30 further receives a desired destination location from the mobile device 20. For example, the user of the mobile device 20 may type in the address or the business name of the destination location on the mobile device 20, and the information is received by the directions calculation module 30.

At block 203, based on the received destination location, the directions calculation module 30 identifies a location-specific image of the destination location. Specifically, for example, the module 30 may request the search engine 26 of the Yellow Pages server 12 to search through the listings database 42 to identify a particular listing corresponding to the destination location as entered by the user. Once a particular listing is identified, it may then be used to identify a location-specific image of the destination location as stored in the images database 40. The identified location-specific image is

associated with the geographic coordinates of the location (i.e., the destination location in this case) at which the image was taken.

In one application, when the mobile device 20 is associated with an IP address, then the IP address may be used to determine a general geographic position of the mobile device 20 thereby selecting a subset of listings that generally correspond to the determined geographic position. For example, when the mobile devices 20 access the navigation server 13 and the image-address database 43 over the wireless communications network 22, it may be preferable to first limit a number of possible listings (and hence their corresponding location-specific images) to search through, especially when the data size contained in the image-address database 43 is large. Most IP addresses are associated with a server that is physically proximate to the locations of the IP address owners. Thus, based on an IP address of the mobile device 20, it is possible to estimate a general geographic position (e.g., city) of the mobile device 20. Then, only those listings corresponding to the general geographic position may be searched, at least initially, to find a listing corresponding to the destination location. Thereafter, a location-specific image corresponding to the listing can be found.

At block 204, the directions calculation module 30 calculates directions from the current position of the mobile device, as determined by any suitable position identification system as described above, to the destination location in reference to the maps-and-directions database 44. Various methods of calculating directions are well known in the art.

Optionally, at block 206, the directions calculation module 30 may then identify one or more landmark points along the calculated directions. For example, any predefined points of interest, such as major intersections, large buildings, parks, etc. can be designated as landmark points in the maps-and-directions database 44. The module 30 automatically selects one or more landmark points along the calculated directions according to any suitable algorithm. For example, the module 30 may select landmark points at a certain interval. As another example, each of the landmark points may be pre-rated according to its importance (or preference), and only those landmark points above a certain preference level may be selected in each application, for example according to a user input.

At block 208, for each of the landmark points identified, the geographic coordinates are found from the maps-and-directions database 44, and may then be used to

find a location-specific image taken at the geographic coordinates from the images database 40.

At block 210, the directions calculation module 30 compiles a navigation program for displaying on the mobile device 20 an image of the destination location, in addition to the ordinary directions and maps for navigating the user to the destination location. The navigation program may be further configured to display images of one or more landmark points along the way to the destination location. Each of these images will be displayed based on the position of the mobile device 20 as determined by the position identification system (e.g., a GPS receiver). Additionally, in one application, the images of the landmark points and the destination location, or any portion thereof, may be stored and/or presented in the form of a video clip. In this application, essentially all locations along the way toward the destination location that are associated with location-specific images (or a portion thereof) are designated as landmark points, and their location-specific images are included in a video clip.

It should be understood that the directions calculation module 30, together with its associated databases, such as the images database 40, the listings database 42, and the maps-and-directions database 44, may be contained in a hard disk 64 and stored in the memory 54 of the mobile device 20. (See FIGURE 1B). Thus, essentially, the navigation service as described above may be made available to the mobile device 20 that may not necessarily interface with a wireless communications network 22.

FIGURE 3 is a flowchart illustrating actions taken when the navigation program generated in accordance with FIGURE 2 is executed. At block 301, the navigation program is executed to display relevant directions and maps in a manner well known in the art. For example, a map of the relevant area may be displayed with an icon representative of the mobile device 20 moving on the map in accordance with the actual movement of the mobile device 20 as determined by the position identification system. Suitable directions in graphical and/or text form may also be displayed.

At block 302, it is determined whether any landmark point is nearing. For example, this determination can be made if any of the landmark points comes within a certain distance from the current position of the mobile device 20 as determined by the position identification system. If so, then at block 304, the image of the landmark point that is nearing can be accessed and displayed on the mobile device 20, with an appropriate message, such as "If you see this, turn right," etc. FIGURE 8 illustrates a

sample screen shot displaying a location-specific image 800 of a landmark point (an intersection in this example), together with suitable directions in both text 802 ("If you see this, turn right") and graphics (a left-turning arrow 804 in the example). The location-specific image 800 can remain displayed until the landmark point is passed. For
5 example, the image 800 can be displayed until the distance between the landmark point and the mobile device 20 starts to increase.

After the mobile device 20 passes the landmark point, returning to block 301 (FIGURE 3), the navigation program resumes displaying ordinary maps-and-directions, while continuing to monitor to see if any other landmark point comes close to the mobile
10 device 20 (block 302).

If, at block 302, it is determined that no landmark point is near the mobile device 20, then proceeding to block 306, it is determined whether the final destination location is nearing. This determination can be made, for example, when the final destination location comes within a certain distance from the current position of the
15 mobile device 20 as determined by the position identification system. If so, then proceeding to block 308, the location-specific image of the final destination is displayed on the mobile device 20. An appropriate message, such as "Your destination looks like this," can be displayed at this time. The image may remain displayed until the user (i.e., the mobile device 20) reaches the destination location.

It should be emphasized that FIGURE 3 illustrates merely one example of actions to be performed when a navigation program is executed, and accordingly, the navigation program in accordance with the present invention is not limited to the particular embodiment disclosed in FIGURE 3. For example, the image of the final destination may be displayed initially upon execution of the navigation program so that the user can view
20 what to look for at his/her destination location prior to starting his/her journey. As another example, a video clip of a series of location-specific images along the way to a final destination (or a portion thereof) may be displayed initially upon execution of the navigation program so that the user can view the entire journey at the outset. As a further example, an image of the final destination may be displayed on the mobile device 20
25 anytime a user's request for such an image is received.

As further extensions of the present invention, various other services may be provided with respect to each of the location-specific images to be displayed. For example, if a user is traveling to a final destination, such as a restaurant, the user may be

permitted to make a reservation at the restaurant upon viewing the location-specific image of the restaurant using his/her mobile device 20. For example, many businesses have Wi-Fi devices which could process various requests, such as reservation requests, received via a wireless communications network 22 from the mobile device 20. As
5 another example, if the final destination is a movie theater, the user of the mobile device 20 may be permitted to purchase movie tickets upon viewing the location-specific image of the movie theater wirelessly over the communications network 22.

Referring back to FIGURE 1A, the mobile image system 10 may further include the shopping assistance server 14. The shopping assistance server 14, as illustrated,
10 includes an operating system 32 and a shopping assistance module 34. Briefly, the shopping assistance server 14, in conjunction with the shopping database 45, etc., allows a user of the mobile device 20 to view images of stores that carry items that the user wishes to purchase.

Specifically, FIGURE 4 illustrates a sample routine 400 for generating a shopping
15 program in accordance with one embodiment of the present invention. At block 401, the shopping assistance module 34 receives a request for a shopping assistance service from a user of the mobile device 20. At block 402, the module 34 receives a shopping list from the user of the mobile device. For example, the user may enter text into his/her mobile device 20 to list items that the user wishes to purchase (stamps, milk, books, etc.). At
20 block 404, for each of the items, the module 34 finds a corresponding "store category" that carries such an item (e.g., "post offices" for stamps, "grocery stores" for milk, "book stores" for books, etc.) This can be determined based on a predefined look-up table, for example, as stored in the shopping database 45. Alternatively, the user may directly enter the store categories in the shopping list as opposed to the items to be purchased.

At block 406, for each of the store categories entered or found, the module 34
25 finds one or more stores listed under the store category and also find the geographic (e.g., longitude/latitude) coordinates of these stores. This can be done, for example, by referring to the listings database 42 included in the database server 11. Specifically, in accordance with various exemplary embodiments of the present invention, the listings
30 database 42 lists various stores, businesses, etc., under each store category, together with their addresses, phone numbers, geographic longitude/latitude coordinates, business hours, etc. Therefore, for each of the store category, a list of stores together with their geographic coordinates can be obtained by searching through the listing database 42. In

one specific application, only those stores that are actually open (according to their business hours information) are returned based on the day and time at which the shopping list was received, as determined by an internal clock of the mobile device 20 or a clock accessible by the shopping assistance server 14. At block 407, optionally, for each of the stores found, a location-specific image can be found. It should be apparent to one skilled in the art that it is not necessary to retrieve the location-specific images of these stores at this point, it is only necessary to be able to access these location-specific images based on their geographic coordinates and the determined position of the mobile device 20, as will be described below.

10 At block 408, the module 34 finally compiles a shopping program for displaying images of the stores that sell the items/products included in the shopping list. Each of these images will be displayed based on the position of the mobile device 20 as determined by the position identification system.

15 It should be understood that the shopping assistance module 34, together with its associated databases, such as the shopping database 45, images database 40, and the listings database 42, etc., may be contained in a hard disk 66 and stored in the memory 54 of the mobile device 20 (see FIGURE 1B). Thus, essentially, the shopping assistance service as described above may be made available to the mobile device 20 that may not necessarily interface with a wireless communications network 22.

20 FIGURE 5 illustrates actions performed during execution of the shopping program generated in accordance with FIGURE 4 above. At block 501, the program monitors for the occurrence of a decision event of block 502. At block 502, it is determined whether any of the stores that may carry an item on the shopping list is nearing the position of the mobile device 20 as determined by the position identification system. For example, this determination can be made if the longitude/latitude coordinates of any of these stores comes within a certain distance from the current position of the mobile device 20. If so, proceeding to block 504, the program alerts the user (for example, by issuing a beeping sound) and displays an image of the store on the mobile device 20 with an appropriate message. FIGURE 9 is a sample screen shot displaying an image 900 of the store that is coming close to the mobile device 20, together with a text message that reads "You can get your ' _____ ' (902--insert the relevant item on the shopping list) at ' _____ ' (904--insert the store name and address) near you." 25 30 In connection with the image of a store 900, directions to the store may further be

calculated and displayed by utilizing the navigation server 13 discussed above. The image of the store 900 can be displayed until the user (or more specifically, the user's mobile device 20) reaches or passes the store. For example, this point of time can be determined when the distance from the mobile device to the store starts to increase.

5 The items to be entered into a shopping list may be general, such as "books," or may be more specific, such as a particular title of a book. In one example, the mobile image system 10 of the present invention may be coupled via the wireless communications network 22 with searchable inventory databases of various bookstores. Then, a particular book title entered in a shopping list as received from the mobile device
10 20 of a user can be searched within these inventory databases to identify only those bookstores that actually carry this particular title. In this example, in FIGURE 4, block 406, only those bookstores that carry this particular title, together with their geographic coordinates, are found. Thereafter, in block 408, a shopping program is compiled for displaying location-specific images of only those bookstores.

15 Referring again back to FIGURE 1A, the mobile image system 10 may further include the recommendations server 16. The recommendations server 16, as illustrated, includes an operating system 36 and a recommendations module 38. The recommendations server 16, in conjunction with the user profiles database 46, the image-address database 43, etc., may cause the mobile device 20 to display
20 location-specific images of the user's "favorite" places. As before, these images will be displayed based on the determined position of the mobile device 20. Each user's "favorite" places are determined in reference to the data contained in the user profiles database 46. Specifically, for each user having a user ID, the user profiles database 46 stores his/her favorite places or information that can be used to determine his/her favorite
25 places in association with his/her user ID.

 A user may actively (explicitly) enter his/her favorite places into the user profiles database 46, for example, by typing in the addresses of the favorite places. Alternatively, a user's favorite places may be presumed (determined) based on the user's observed behavior on the mobile image system 10. For example, when the user accesses the
30 navigation service provided by the navigation server 13 and enters a certain destination location, the destination location may be presumed to be the user's favorite place and stored as such in the user's profile. Likewise, if the user accesses the shopping assistance service provided by the shopping assistance server 14 and enters a shopping list including

certain items, the stores that carry those items may be presumed to be the user's favorite places and added to the user's profile. As another example, if a user's profile contains a list of the user's favorite books, for each of these books, a list of geographic locations that appear in the book may be compiled (e.g., the name of a restaurant that a book's main character visits). Then, these geographic locations may be presumed to be the user's favorite places, and added to the user's profile in the database 46. Further alternatively, if no information is available regarding the preferences or past behavior of a particular user, general favorite places (e.g., favorite places of other users) may be presumed to be one of this user's favorite places also. Therefore, each user of the mobile device 20 accessing the recommendations service has a user ID, and has an associated user profile included in the user profiles database 46 (although the amount and content of information included in each user profile may vary), which can be used to determine the user's favorite places. Note that a user ID does not necessarily coincide with a device ID; in some applications one mobile device may be shared by multiple users each having his/her own user ID and a user profile.

FIGURE 6 is a flow chart illustrating a sample routine 600 for generating a favorite places program in accordance with one embodiment of the present invention. At block 601, the recommendations module 38 receives a request for a recommendations service from the mobile device 20. At block 602, the module 38 forms a list of the favorite places of the user requesting the recommendations service. To this end, the module 38 refers to the user profiles database 46 and retrieves the user's favorite places stored in the user's profile and/or determines the user's favorite places based on the information contained in the user's profile. At block 603, the module 38 then finds geographic coordinates for each of the user's favorite places, in reference to the image-address database 43. Finally, at block 604, the module 38 compiles a favorite places program for displaying location-specific images of the favorite places when the user is near or at these favorite places, based on the determined position of the mobile device 20.

FIGURE 7 is a flowchart illustrating actions taken during execution of the favorite places program generated in accordance with FIGURE 6. At block 701, the program monitors for the occurrence of a decision event of block 702. At the decision block 702, it is determined whether any of the favorite places is nearing. For example, this determination can be made when the determined position of the mobile device 20 comes

within a certain distance from the longitude/latitude coordinates of any of the favorite places. If so, at block 704, the program alerts the user (e.g., by issuing a beep sound), and displays an image of the favorite place on the mobile device 20 together with an appropriate message.

5 FIGURE 10 is a sample screen shot displaying an image 1000 of a favorite place (a library in this example) that is coming close to the mobile device 20, together with a text message that reads "Your favorite ' _____ ' (1002--insert the place name, for example "library") is near you at ' _____ ' (1004--insert the place address)." In connection with the image of the favorite place 1000, directions to the favorite place may
10 further be calculated and displayed by utilizing the navigation server 13 discussed above. The image of the favorite place can remain displayed until the user (or more specifically, the user's mobile device 20) reaches or passes the favorite place.

In various applications of the present invention, a location-specific image selected for a user based on his/her user ID may be supplemented with further information
15 available from his/her user profile. For example, when an image of a place that the user has visited in the past is selected based on his/her user profile, the date on which the user last visited the place may be obtained and used to calculate the period of time that has passed since that time. Then, the image can be displayed on the user's mobile device together with a message such as "It's been ' __ ' months/years since you last visited your
20 favorite ' _____ ' (insert the place name, address, etc.)." Other types of supplemental information to annotate a selected image include, for example, a list of items that the user has purchased at a place in the image, or a title of a book in which a place in the image appears together with any rating that the user has given to the book.

Accordingly, the present invention provides methods and systems that permit a
25 user of a mobile device to view location-specific images in various situations, for example when trying to reach a certain destination location or to purchase items on a shopping list. In all of these situations, the methods and systems display location-specific images based on the determined position of the mobile device so that the location-specific images are displayed in a timely and geographically relevant manner to assist the user in
30 finding and reaching the desirable locations.

While the preferred embodiments of the invention have been illustrated and described, it will be appreciated that various changes can be made therein without departing from the spirit and scope of the invention.

The embodiments of the invention in which an exclusive property or privilege is claimed are defined as follows:

1. A system for providing location-specific images to a mobile device for display, comprising:

a mobile device comprising a processor, memory, and screen;

a position identification system that determines the position of the mobile device;

and

a location-specific images database including images taken at locations, each image being associated with geographic coordinates of the location at which the image was taken;

wherein, the position of the mobile device is identified by the mobile device position identification system, and a location-specific image is selected from the images database based on the determined position of the mobile device and displayed on the screen of the mobile device.

2. The system of Claim 1, wherein the mobile device is selected from the group consisting of a cellular phone, a PDA, a portable computer, a navigation system, and a mobile computer communicator.

3. The system of Claim 1, wherein the position identification system utilizes a device-based technology to determine the position of the mobile device.

4. The system of Claim 3, wherein the position identification system comprises a GPS receiver.

5. The system of Claim 1, wherein the location-specific images database resides in the memory of the mobile device.

6. The system of Claim 1, further comprising:

a wireless communications network, with which the mobile device interfaces; and

a mobile image system that interfaces with the wireless communications network, the mobile image system comprising the location-specific images database.

7. The system of Claim 6, wherein the position identification system utilizes a network-based technology to determine the position of the mobile device based on a link between the mobile device and the mobile image system.

8. The system of Claim 6, wherein the position identification system utilizes a device-based technology and a network-based technology.

9. The system of Claim 6, wherein the mobile device further comprises an image capturing subsystem, and is capable of performing the steps comprising:

capturing an image;

associating the captured image with the determined position of the mobile device at the time when the image was captured so as to produce a location-specific image; and

transmitting the location-specific image over the wireless communications network to the location-specific images database in the mobile image system.

10. The system of Claim 1, wherein the location-specific image is selected when the determined position of the mobile device comes within a certain distance from the geographic coordinates associated with the image.

11. The system of Claim 1, wherein the system comprises a directions system that performs the steps comprising:

receiving at the mobile device a destination location where a user of the mobile device wishes to go;

calculating directions from the determined position of the mobile device to the destination location; and

generating a directions program comprising the calculated directions to the designation location, the directions program further comprising instructions for displaying on the screen of the mobile device an image of the destination location based on the determined position of the mobile device.

12. The system of Claim 11, wherein the image of the destination location is displayed when the determined position of the mobile device comes within a certain distance from the destination location.

13. The system of Claim 11, wherein the directions program displays the image of the destination location on the screen of the mobile device upon a user request.

14. The system of Claim 11, wherein the directions program further comprises instructions for displaying on the screen of the mobile device one or more images of landmark locations along the directions toward the destination location, the one or more images being displayed based on the determined position of the mobile device.

15. The system of Claim 14, wherein the images of landmark locations are displayed as a video clip.

16. The system of Claim 1, wherein the system comprises a shopping system that performs the steps comprising:

receiving at the mobile device a shopping list, the shopping list comprising one or more items that a user of the mobile device wishes to purchase;

for each of the items in the list, identifying one or more businesses that carry the item;

for each of the one or more identified businesses, determining its geographic coordinates and identifying its location-specific image; and

generating a shopping list program comprising instructions for displaying on the screen of the mobile device an image of the one or more identified businesses based on the determined position of the mobile device.

17. The system of Claim 16, wherein the image of a business is displayed when the determined position of the mobile device comes within a certain distance from the geographic coordinates of the business.

18. The system of Claim 16, wherein the shopping list program further comprises instructions for issuing an audio signal to alert the user when the image of a business is displayed.

19. The system of Claim 1, further comprising:

(a) a wireless communications network, with which the mobile device interfaces; and

(b) a mobile image system that interfaces with the wireless communications network, the mobile image system comprising the location-specific images database, a user profiles database, and a recommendations server, wherein the recommendations server performs the steps comprising:

(i) receiving from the mobile device a request for a recommendations service;

(ii) accessing a profile of the user of the mobile device in the user profiles database to identify one or more favorite places of the user;

(iii) determining geographic coordinates of the one or more favorite places; and

(iv) generating a favorite places program comprising instructions for displaying on the screen of the mobile device an image of the one or more favorite places based on the determined position of the mobile device.

20. The system of Claim 19, wherein the image of a favorite places is displayed when the determined position of the mobile device comes within a certain distance from the geographic coordinates of the favorite place.

21. The system of Claim 19, wherein the favorite places program further comprises instructions for issuing an audio signal to alert the user when the image of a favorite place is displayed.

22. A method of displaying a location-specific image on a mobile device based on the position of the mobile device, the method comprising:

(a) receiving a position of a mobile device;

(b) selecting a location-specific image from multiple location-specific images based on the received position of the mobile device, each location-specific image being associated with geographic coordinates of the location at which the image was taken; and

(c) sending the selected image to the mobile device.

23. The method of Claim 22, wherein the location-specific image is selected when the received position of the mobile device comes within a certain distance from the geographic coordinates associated with the image.

24. The method of Claim 22, further comprising receiving a user ID via the mobile device.

25. The method of Claim 24, wherein the step (b) comprises selecting a location-specific image based on the received user ID.

26. The method of Claim 24, further comprising the step of determining supplemental information for the selected image based on the received user ID and sending the supplemental information to the mobile device.

27. The method of Claim 24, wherein the step (b) comprises accessing a user profile associated with the received user ID and selecting a location-specific image based on the user profile.

28. The method of Claim 22, further comprising:
receiving a search query from the mobile device;
wherein the step (b) comprises selecting a location-specific image based on the received search query.

29. The method of Claim 22, wherein the step (a) comprises receiving a position of a mobile device as entered into the mobile device by a user.

30. The method of Claim 22, wherein the step(a) comprises receiving a position of a mobile device from a GPS receiver.

31. The method of Claim 22, wherein the step (a) comprises receiving a position of a mobile device from a wireless communications network, with which the mobile device interfaces.

32. The method of Claim 31, further comprising the steps of:
determining a general geographic location of the mobile device based on an IP address associated with the mobile device; and
identifying a subset of location-specific images that correspond to the determined general geographic location of the mobile device;

wherein the step (b) comprises selecting a location-specific image from the identified subset of location-specific images based on the determined position of the mobile device.

33. A mobile device capable of displaying a location-specific image based on a determined position of the mobile device, the mobile device comprising:

- (a) a screen; and
- (b) a processor loaded with processor-executable instructions for performing the steps comprising:
 - (i) receiving a position of the mobile device as determined by a position identification system;
 - (ii) selecting a location-specific image from a set of location specific images based on the determined position of the mobile device; and
 - (iii) displaying the selected location-specific image on the screen.

34. The mobile device of Claim 33, wherein the position identification system comprises a GPS receiver coupled with the mobile device, and the step (b)(i) comprises receiving a position of the mobile device as determined by the GPS receiver.

35. The mobile device of Claim 33, further comprising a wireless network interface for establishing a wireless communications link between the mobile device and a mobile image system via a wireless communications network,

wherein the position identification system utilizes a network-based technology to determine the position of the mobile device based on a link between the mobile device and the mobile image system over the wireless communications network, and the step (b)(i) comprises receiving the position of the mobile device as determined according to the network-based technology.

36. The mobile device of Claim 35, wherein the mobile image system comprises a location-specific images database containing the set of location-specific images, and the step (b)(ii) comprises selecting a location-specific image from the set of images as stored in the location-specific images database.

37. The mobile device of Claim 33, further comprising a memory that is pre-loaded with the set of location-specific images, and the step (b)(ii) comprises selecting a location-specific image from the set of location-specific images in the memory.

38. A system for providing location-specific images to a mobile device for display, comprising:

means for receiving a position of a mobile device;

a location-specific images database including images taken at locations, each image being associated with geographic coordinates of the location at which the image was taken;

means for selecting a location-specific image from the images database based on the received position of the mobile device; and

means for sending the selected image to the mobile device.

39. The system of Claim 38, wherein the means for selecting a location-specific image selects a location-specific image when the received position of the mobile device comes within a certain distance from the geographic coordinates associated with the image.

40. The system of Claim 38, further comprises a directions system comprising:

means for receiving a destination location;

means for calculating directions from the received position of the mobile device to the destination location; and

means for generating a directions program comprising the calculated directions to the designation location, the directions program further comprising instructions for sending an image of the destination location to the mobile device based on the received position of the mobile device.

41. The system of Claim 38, further comprises a shopping system comprising:

means for receiving a shopping list, the shopping list comprising one or more items that a user of the mobile device wishes to purchase;

means for identifying one or more businesses that carry each of the items in the list;

means for determining the geographic coordinates of each of the one or more identified businesses and identifying a location-specific image for each of the one or more identified businesses; and

means for generating a shopping list program comprising instructions for sending an image of the one or more identified businesses to the mobile device based on the received position of the mobile device.

42. The system of Claim 38, further comprising a recommendations system comprising:

a user profile database including user profiles;

means for accessing a profile of a user upon receiving from the user a request for a recommendations service;

means for identifying one or more favorite places of the user based on the user profile;

means for determining geographic coordinates of the one or more favorite places; and

means for generating a favorite places program comprising instructions for sending an image of the one or more favorite places to the mobile device based on the determined position of the mobile device.

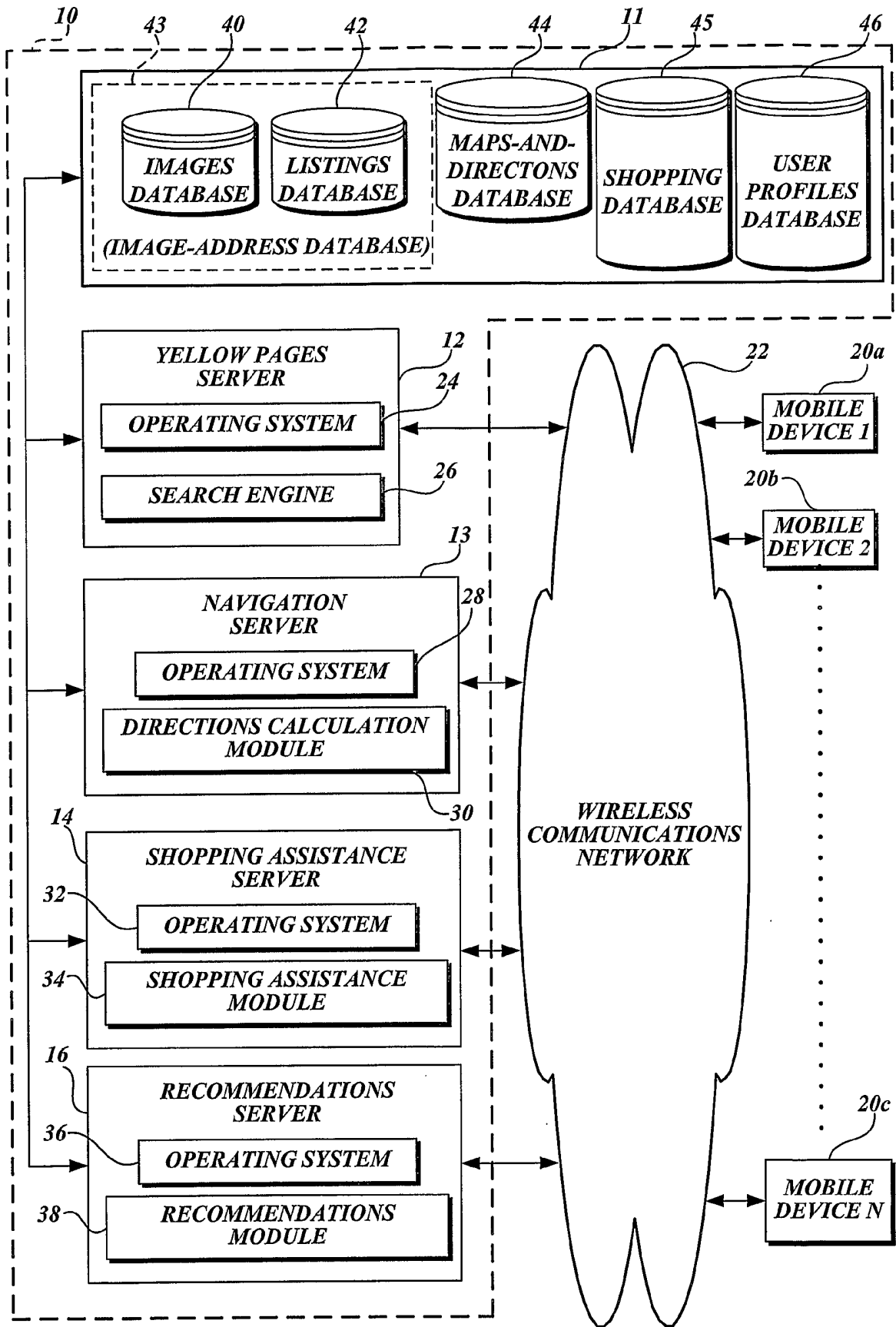

Fig. 1A.

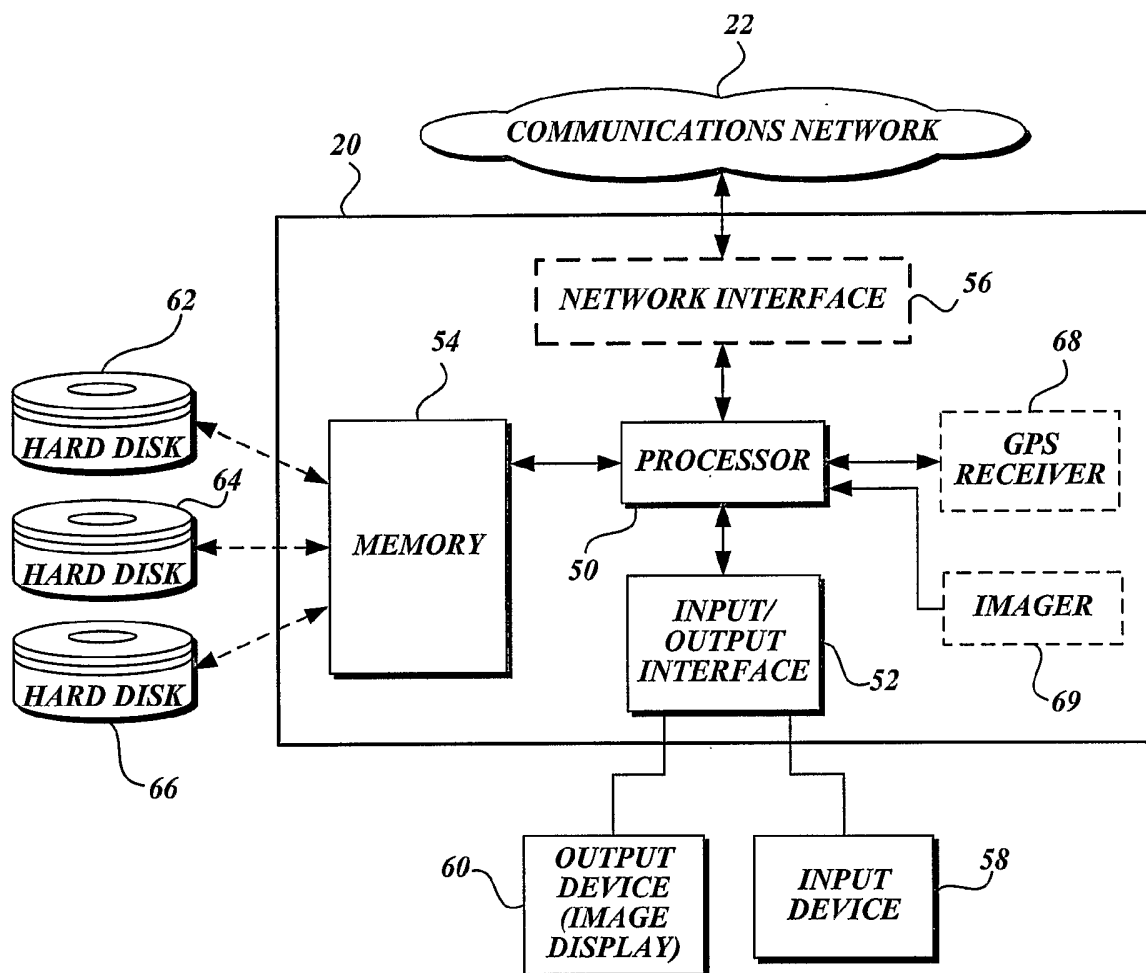

Fig. 1B.

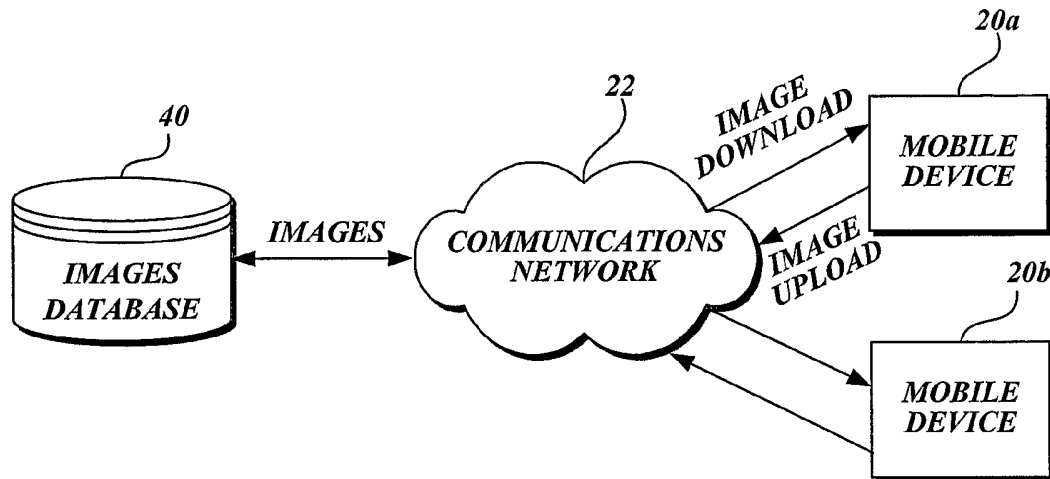

Fig.1C.

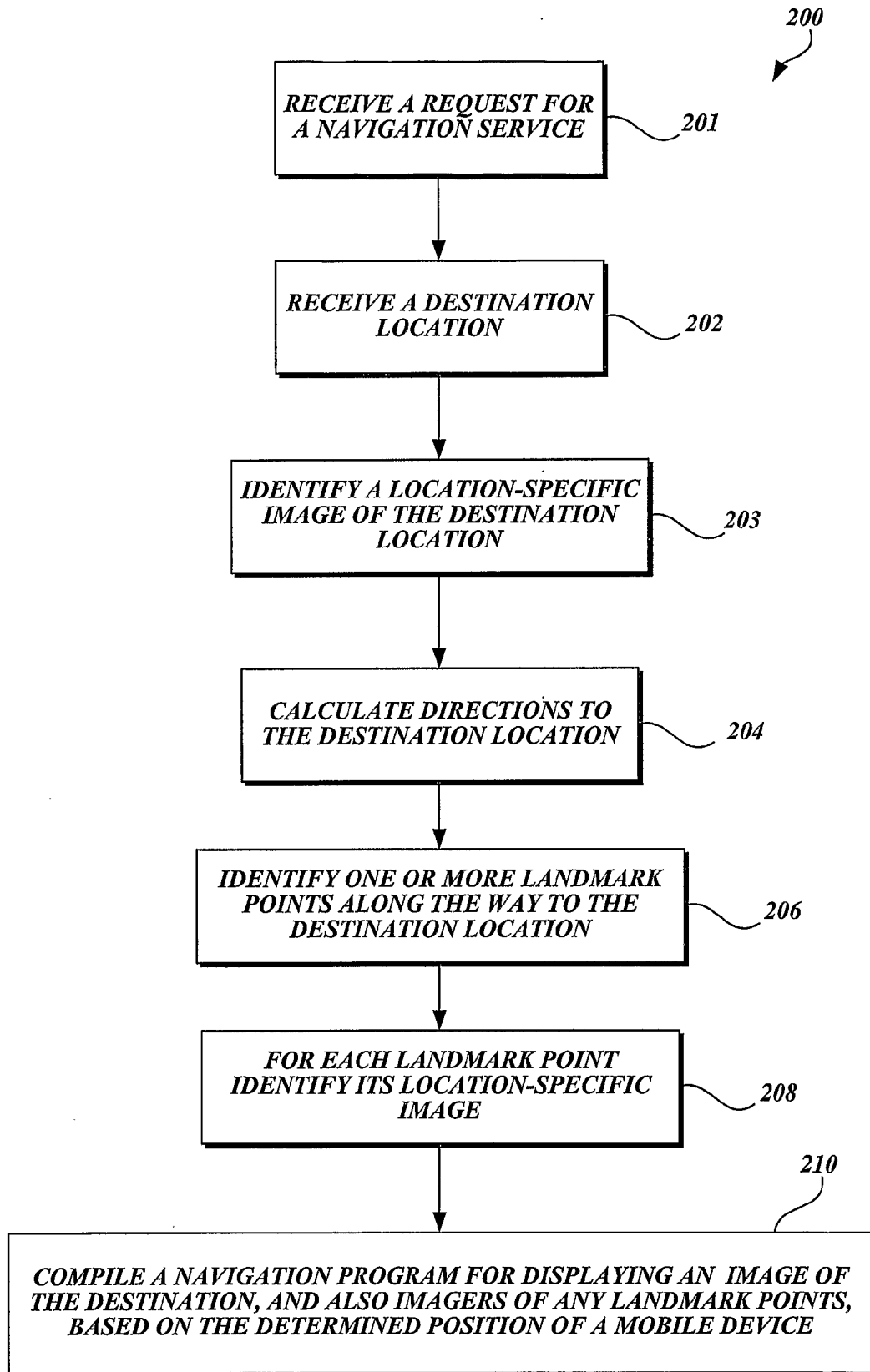

Fig. 2.

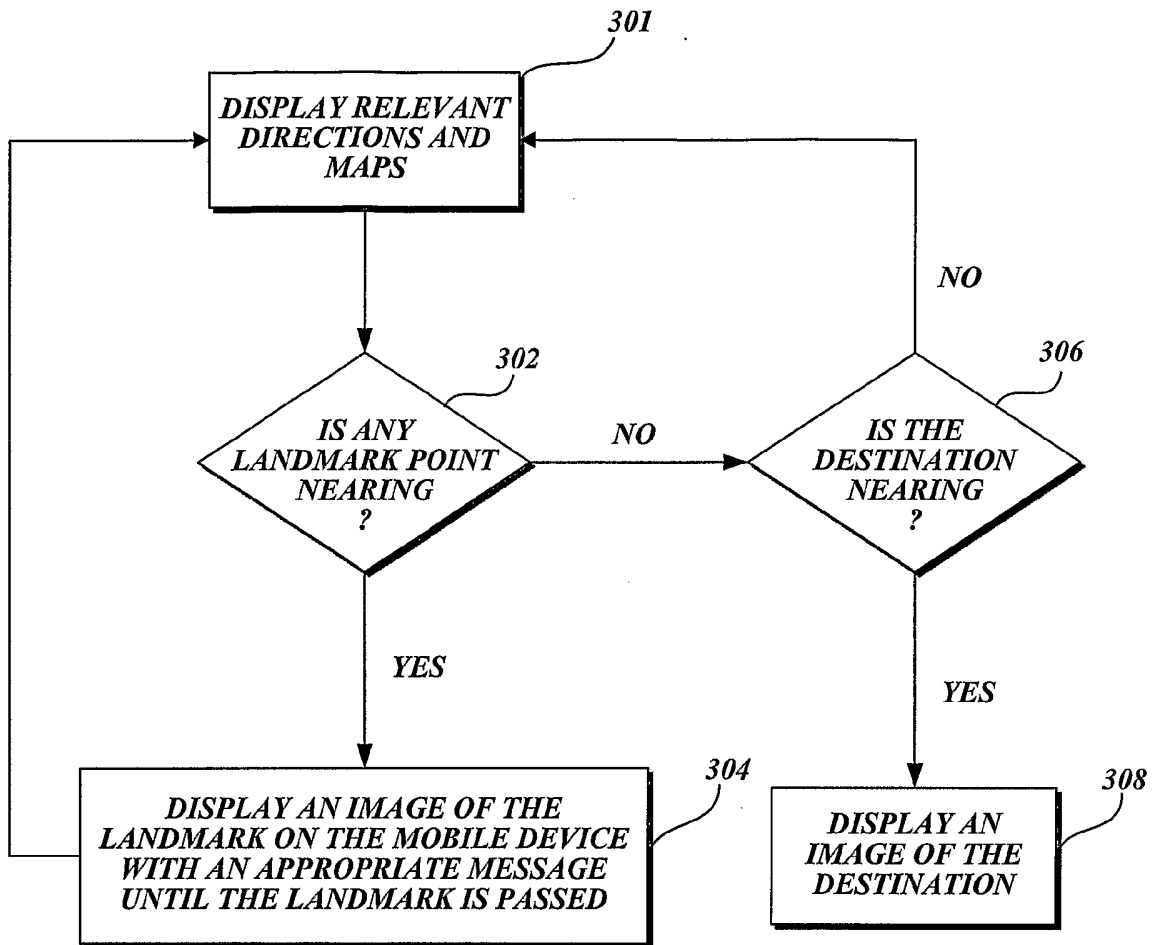
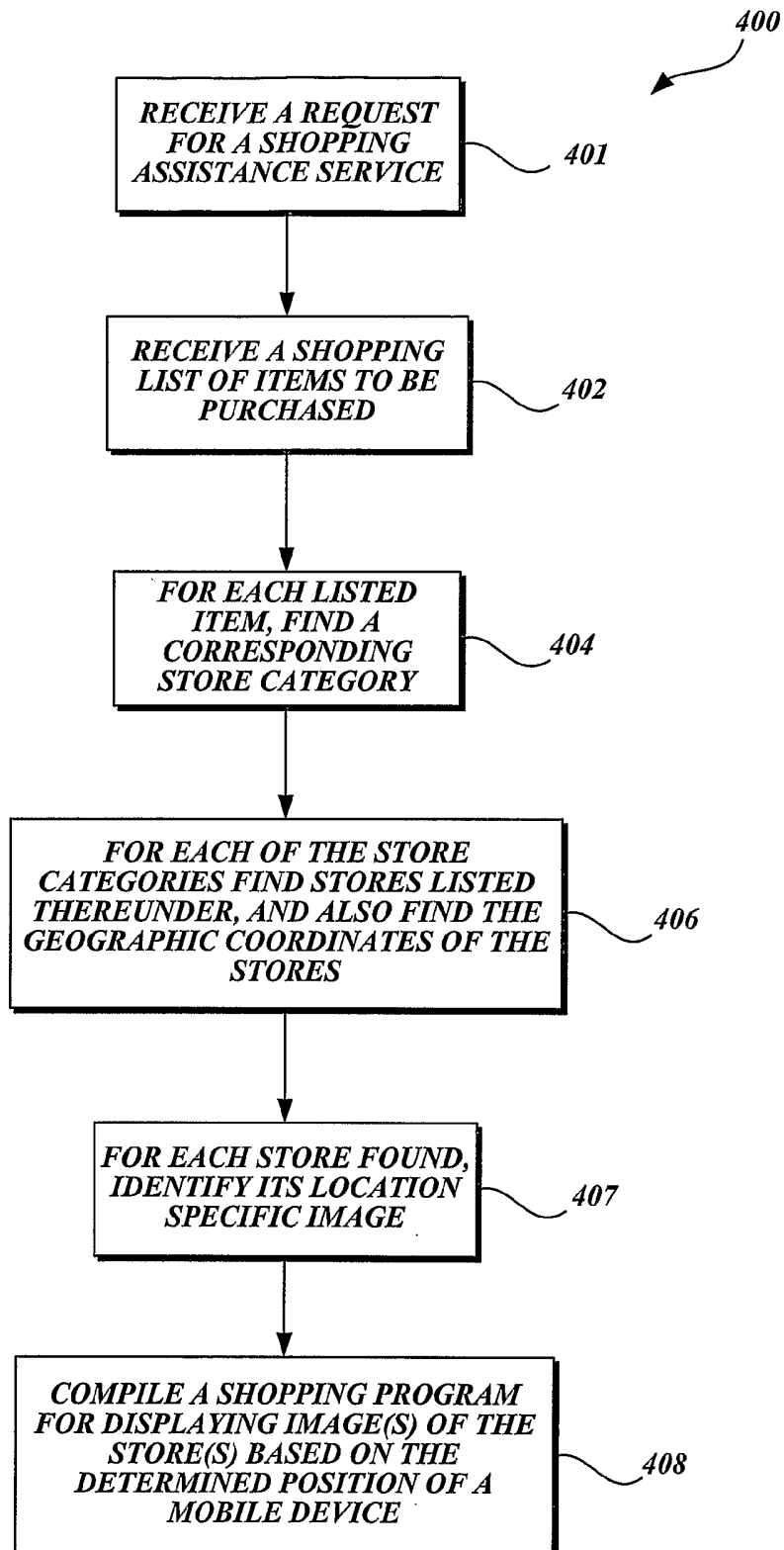

Fig.3.

*Fig. 4.*

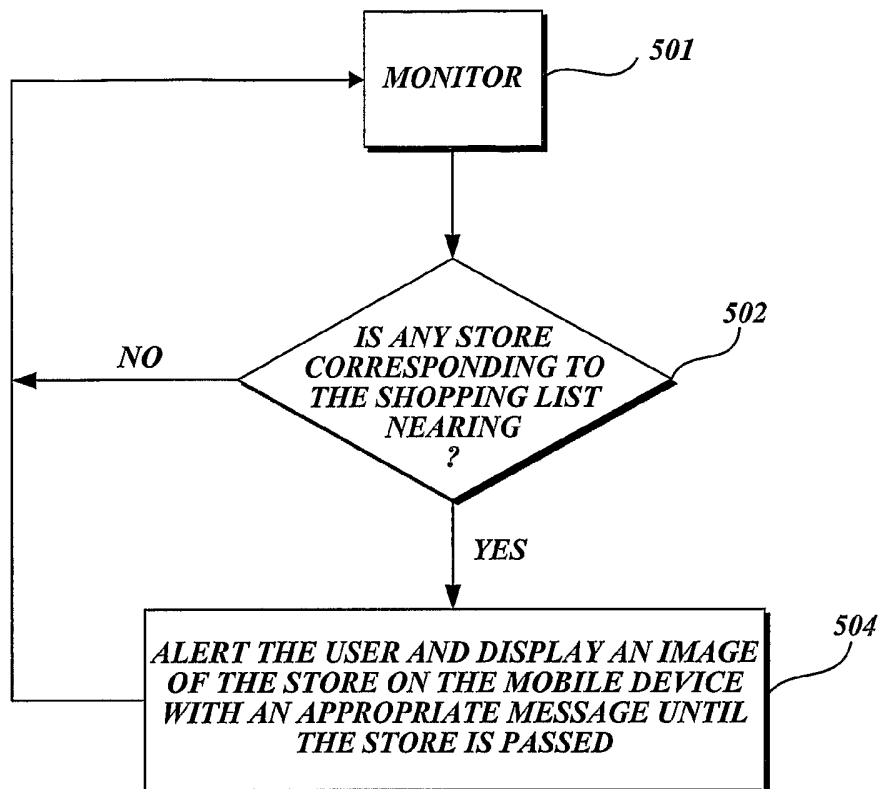

Fig. 5.

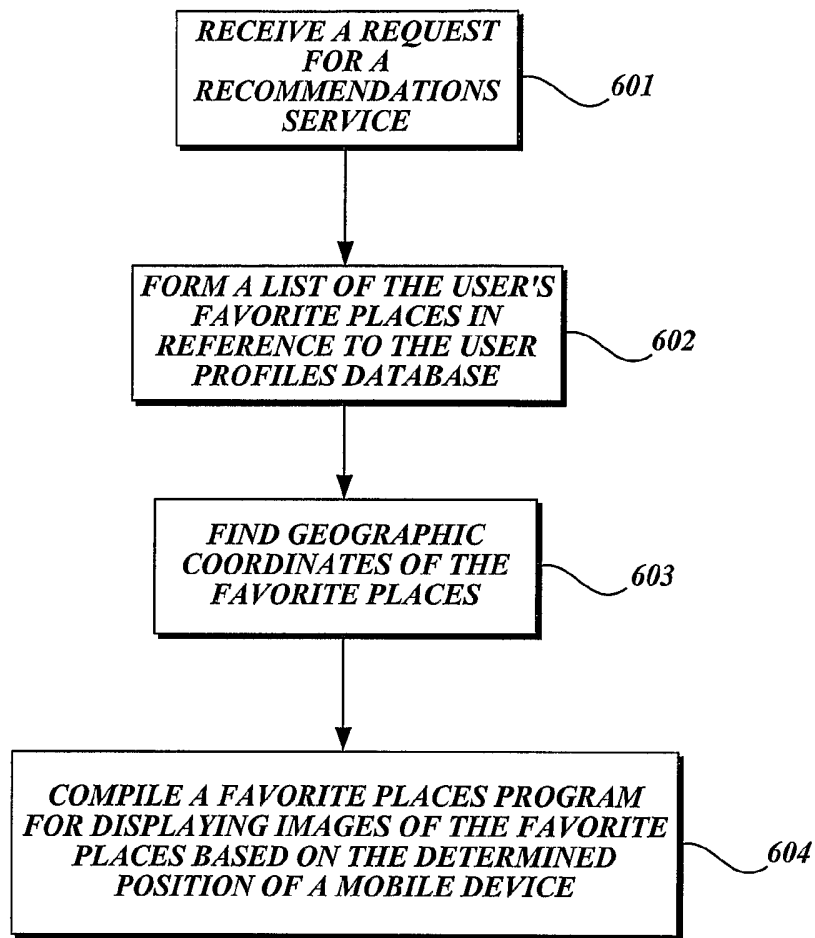

Fig. 6.

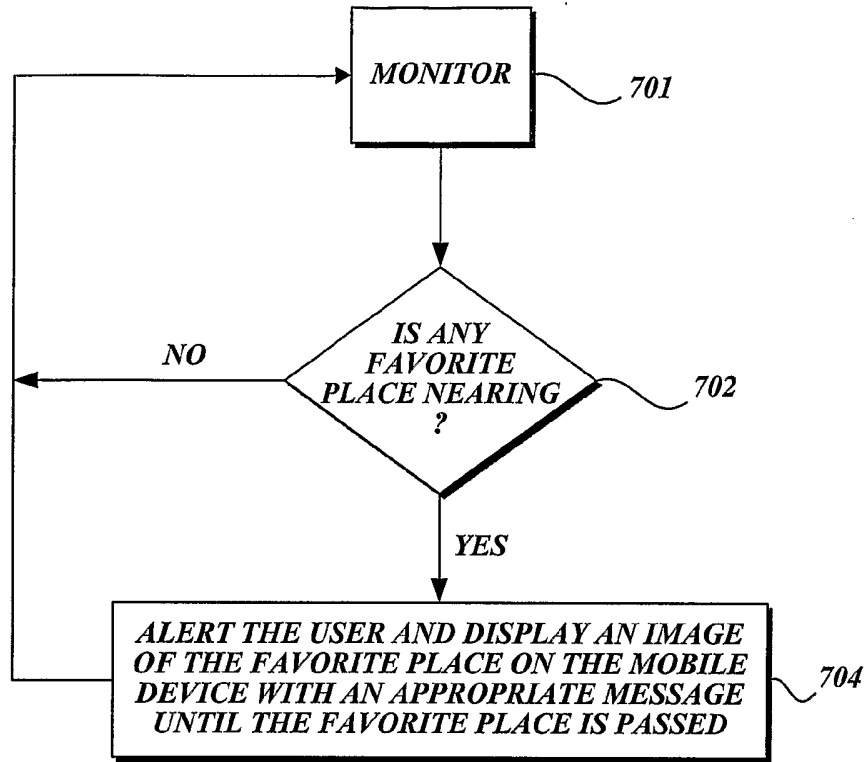

Fig. 7.

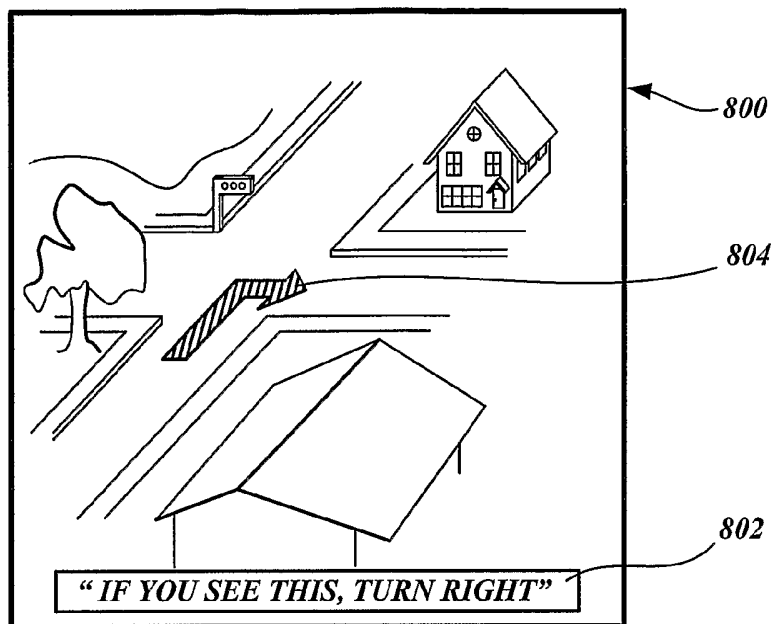

Fig. 8.

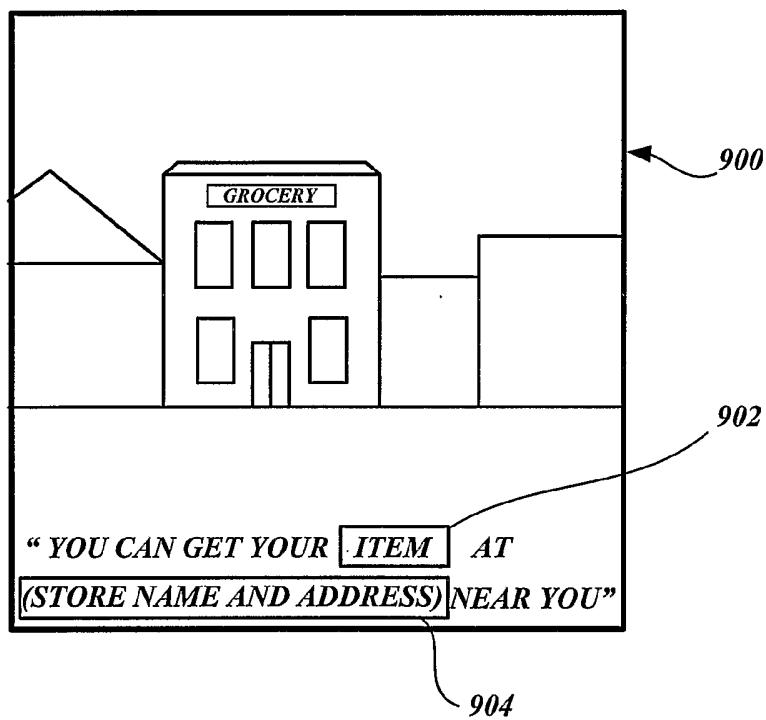

Fig. 9.

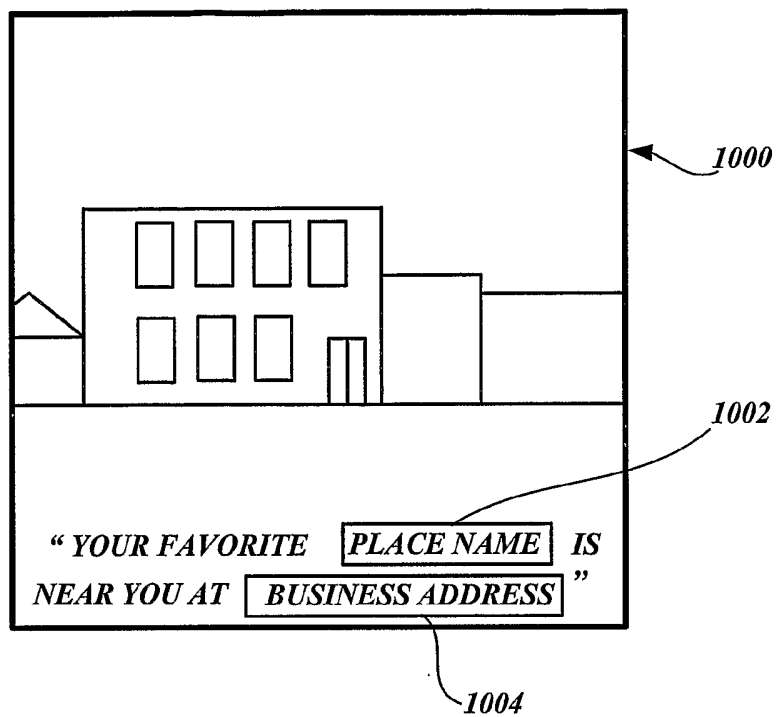

Fig.10.