

(19) World Intellectual Property
Organization
International Bureau



(43) International Publication Date
1 December 2005 (01.12.2005)

PCT

(10) International Publication Number
WO 2005/112787 A2

(51) International Patent Classification⁷: **A61B 17/04**

(21) International Application Number:
PCT/US2005/017028

(22) International Filing Date: 16 May 2005 (16.05.2005)

(25) Filing Language: English

(26) Publication Language: English

(30) Priority Data:
60/521,528 14 May 2004 (14.05.2004) US

(71) Applicant (for all designated States except US): **QUILL
MEDICAL, INC.** [US/US]; 2505 Meridian Parkway, Suite
150, Research Triangle Park, NC 27713 (US).

(72) Inventors; and

(75) Inventors/Applicants (for US only): **RUFF, Gregory,
L.** [US/US]; 118 Campbell Lane, Chapel Hill, NC 27514

(US). **LEUNG, Jeffrey C.** [US/US]; 4413 White Chapel
Way, Raleigh, NC 27615 (US). **KAPLAN, Andrew**
[US/US]; 1027 Crown Court, Hillsborough, NC 27278
(US). **MEGARO, Matthew, A.** [US/US]; 118 Stoneridge
Drive, Chapel Hill, NC 27514 (US). **BATCHELOR,
Stanton, D.** [US/US]; 112 Creek Haven Drive, Holly
Springs, NC 27540 (US).

(74) Agent: **WITSIL, Matthew, W.**; P.O. Box 13706, 430
Davis Drive, Suite 500, Research Triangle Park, NC 27709
(US).

(81) Designated States (unless otherwise indicated, for every
kind of national protection available): AE, AG, AL, AM,
AT, AU, AZ, BA, BB, BG, BR, BW, BY, BZ, CA, CH, CN,
CO, CR, CU, CZ, DE, DK, DM, DZ, EC, EE, EG, ES, FI,
GB, GD, GE, GH, GM, HR, HU, ID, IL, IN, IS, JP, KE,
KG, KM, KP, KR, KZ, LC, LK, LR, LS, LT, LU, LV, MA,
MD, MG, MK, MN, MW, MX, MZ, NA, NG, NI, NO, NZ,
OM, PG, PH, PL, PT, RO, RU, SC, SD, SE, SG, SK, SL,

[Continued on next page]

(54) Title: SUTURE METHODS AND DEVICES

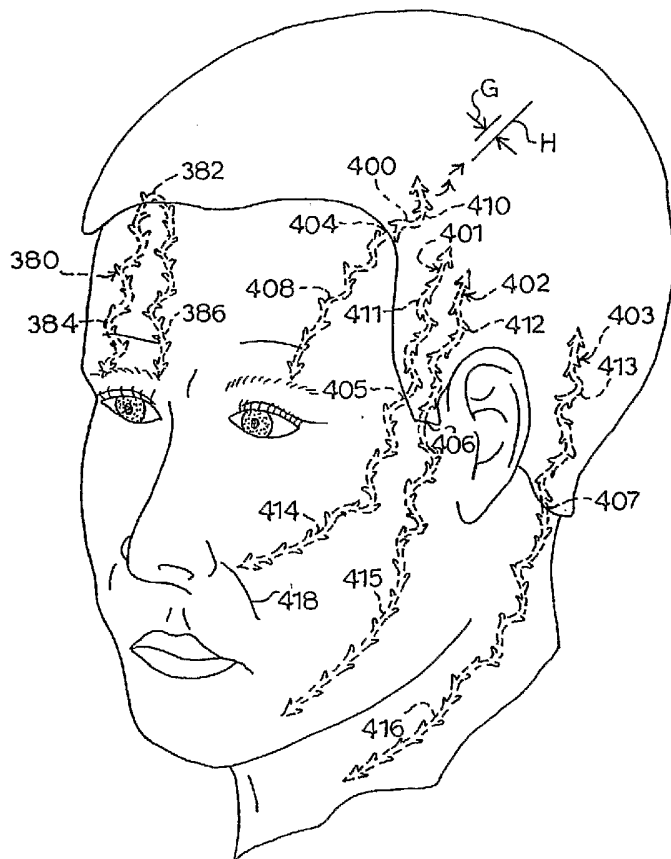

(57) Abstract: A barbed suture including a body with barbs on the periphery, a pointed end, and an anchor at one end to resist movement of the suture in the direction of the pointed end is provided. One or more limbs on the anchor may be provided, which may be arcuate, of varying lengths, and varying distribution about the periphery of the suture body. Other anchor designs are provided. Methods of placing single-directional and bi-directional barbed sutures to approximate the tissue on each side of a wound and to position and support tissue in the absence of a wound, as in cosmetic surgery, are provided, and may include terminal J-stitches or S-stitches. Methods of placement may be made with sharp, pointed ends, which may be needles, or insertion devices. Sinusoidal patterns of sutures that have amplitudes generally perpendicular to the resultant holding force of the suture are provided.

WO 2005/112787 A2



SM, SY, TJ, TM, TN, TR, TT, TZ, UA, UG, US, UZ, VC,
VN, YU, ZA, ZM, ZW.

SE, SI, SK, TR), OAPI (BF, BJ, CF, CG, CI, CM, GA, GN,
GQ, GW, ML, MR, NE, SN, TD, TG).

(84) Designated States (*unless otherwise indicated, for every kind of regional protection available*): ARIPO (BW, GH, GM, KE, LS, MW, MZ, NA, SD, SL, SZ, TZ, UG, ZM, ZW), Eurasian (AM, AZ, BY, KG, KZ, MD, RU, TJ, TM), European (AT, BE, BG, CH, CY, CZ, DE, DK, EE, ES, FI, FR, GB, GR, HU, IE, IS, IT, LT, LU, MC, NL, PL, PT, RO,

Published:

— *without international search report and to be republished upon receipt of that report*

For two-letter codes and other abbreviations, refer to the "Guidance Notes on Codes and Abbreviations" appearing at the beginning of each regular issue of the PCT Gazette.

SUTURE METHODS AND DEVICES

Background

The present invention relates generally to methods and devices for joining or positioning bodily tissue in surgical applications and wound repair, and more particularly to a surgical suturing method and devices for joining or
5 positioning bodily tissue using a suture having a plurality of barbs that permit the suture to be pulled through the tissue in one direction but resist movement of the suture relative to the tissue in the opposite direction.

Single-directional barbed sutures have a plurality of barbs that permit the suture to be pulled through tissue in one direction, but resist movement of the suture in the tissue in the opposite direction. Such sutures may have one end that is pointed to allow penetration and passage through tissue in the one direction and another end that is an
10 anchor which engages the tissue at the initial insertion point to prevent further movement in the one direction. Bi-directional barbed sutures may have barbs extending in one direction at one end and opposing barbs at the other end, preventing movement of the suture through tissue in either direction between two pointed ends.

Methods for placement of barbed sutures in tissue include, but are not limited to, straight, zig-zag, and curvilinear patterns such as alpha, sinusoidal, and corkscrew. In general such patterns terminate in an alignment
15 coincident with the pattern, meaning, for example, that a straight pattern terminates along a straight path, a sinusoidal pattern terminates along a sinusoidal path, and so forth.

Barbed sutures may be used to approximate tissue adjacent to a wound or a tissue separation, or to position and support tissue where there is no wound in procedures such as cosmetic surgery.

Summary

20

According to the present invention a barbed suture is provided including an elongated body, one pointed end, a plurality of barbs extending from the periphery of the body, and one end having an anchor. The barbs permit movement of the suture through the tissue in the direction of movement of the pointed end and prevent movement of the suture in a direction opposite the direction of movement of the pointed end. The anchor includes at least one
25 arcuate limb extending outside the periphery of the body to a greater degree than the barbs, and prevents movement of the suture in the direction of movement of the pointed end. A variety of anchor designs are provided, including but not limited to anchors with arcuate limbs evenly or unevenly spaced around the body and with equal or differing lengths, with or without segments attached. The anchors may, for example, collapse, have a hook shape, clip shape, "T" shape with segments mounted to the "T", a harpoon end, a loop end, hemispherical shape, cone-flower shape, or
30 the shape of an "M".

Also according to the present invention is a method of placing a barbed suture in bodily tissue. The suture includes at least one pointed end and a central portion having barbs that allow movement of the suture in the direction of movement of the pointed end and resist movement of the suture away from the direction of movement of the pointed end. The method includes inserting the pointed end of the suture in the tissue, and then advancing the suture
35 through the tissue such that the central portion is disposed along a first path. The suture deviates from the first path proximate to the at least one pointed end of the suture along a second path, and the second path forms an angle with the projected first path, had the suture remained on the first path, of at least approximately 30 degrees.

Further according to the present invention, a method of placing a barbed suture in bodily tissue to approximate tissue on each side of a wound is provided. The suture includes at least one pointed end and a central
40 portion having barbs that allow movement of the suture in the direction of movement of the pointed end and resist

movement of the suture away from the direction of movement of the pointed end. The method includes inserting the pointed end of the suture in the tissue and then advancing the suture through the tissue along a first path. Then the suture deviates from the first path to follow a second path generally disposed laterally away from the wound. The suture further deviates from the second path proximate to the at least one pointed end of the suture along a third path, and the third path forms an angle with the projected second path, had the suture remained on the second path, of at least approximately 30 degrees.

Yet further in accordance with the present invention, a method of placing a single-directional barbed suture in bodily tissue to approximate a wound is provided. The suture includes an elongated body, one pointed end, one end terminating in an anchor, and a plurality of barbs extending from the periphery of the body. The anchor extends outside the periphery of the body to a greater degree than the barbs. The barbs permit movement of the suture through the tissue in the direction of movement of the pointed end and prevent movement of the suture in a direction opposite the direction of movement of the pointed end. The anchor prevents movement of the suture in the direction of movement of the pointed end. The method includes inserting the pointed end of the suture into one face of the wound and advancing the suture through the tissue until the anchor achieves adequate holding strength in the tissue to resist further movement in the tissue, leaving the anchor embedded in the tissue.

Also in accordance with the present invention, a method of placing a single-directional suture in tissue using an insertion device is provided. The suture includes an elongated body, one pointed end, one end terminating in an anchor, and a plurality of barbs extending from the periphery of the body. The anchor, when extended, extends outside the periphery of the body to a greater degree than the barbs. The barbs permit movement of the suture through the tissue in the direction of movement of the pointed end and prevent movement of the suture in a direction opposite the direction of movement of the pointed end. The anchor prevents movement of the suture in the direction of movement of the pointed end. The insertion device includes a tubular element in which the suture body is at least in part initially disposed and having leading and trailing ends with openings therein with the pointed end of the suture proximate to the leading end. The method includes inserting the pointed end of the suture and the leading end of the insertion device into the tissue at an insertion point. The pointed end of the suture and the leading end of the insertion device are pushed through the tissue until reaching an endpoint. The insertion device is gripped and pulled at the trailing end to remove the insertion device. Tissue is manually grouped and advanced along the suture as desired.

Also according to the present invention another method of placing a single-directional suture in tissue using an insertion device is provided. The suture includes an elongated body, one pointed end, one end terminating in an anchor, and a plurality of barbs extending from the periphery of the body. The anchor, when extended, extends outside the periphery of the body to a greater degree than the barbs. The barbs permit movement of the suture through the tissue in the direction of movement of the pointed end and prevent movement of the suture in a direction opposite the direction of movement of the pointed end. The anchor prevents movement of the suture in the direction of movement of the pointed end. The insertion device includes a tubular element having leading and trailing ends. The method includes inserting the leading end of the insertion device at an insertion point and through the tissue until reaching an endpoint and inserting a leading end of the suture into the insertion device at least until the trailing end of the suture is within the insertion device. A plunger is inserted into the trailing end of the insertion device to abut the trailing end of the suture. The plunger is depressed to push the leading end of the suture out of the insertion device. The insertion device is gripped and pulled at the trailing end to remove the insertion device, leaving the suture in place. The tissue is manually grouped and advanced along the body of the suture as desired.

Also in accordance with the present invention, a method of performing a surgical procedure using a bi-directional barbed suture is provided. The barbed suture includes an elongated body, first and second sharp pointed distal ends for penetrating tissue, and a plurality of barbs extending from the periphery of the body. The barbs on a first portion of the body between the first end of the suture and a first axial location on the body permit movement of the suture through the tissue in a direction of movement of the first end and prevent movement of the suture relative to the tissue in a direction opposite the direction of movement of the first end. The barbs on a second portion of the body between the second end of the suture and a second axial location on the body which is less than the distance from the second end to the first axial location permit movement of the suture through the tissue in a direction of movement of the second end and prevent movement of the suture relative to the tissue in a direction opposite the direction of movement of the second end. An insertion device is used and includes a tubular element and leading and trailing ends. The method includes inserting the leading end of the insertion device at an insertion point in the tissue, and then advancing the leading end of the insertion device through tissue until reaching a selected point. The first pointed end of the suture is inserted into the insertion device at least until one barb extends out of the insertion device. The insertion device is gripped and pulled at the trailing end to remove the insertion device, leaving the full length of the suture in place in the tissue. Tissue is manually grouped and advanced along the body of the suture as desired.

Also in accordance with the present invention is another method of performing a surgical procedure using a bi-directional barbed suture. The barbed suture includes an elongated body, first and second sharp pointed distal ends for penetrating tissue, and a plurality of barbs extending from the periphery of the body. The barbs on a first portion of the body between the first end of the suture and a first axial location on the body permit movement of the suture through the tissue in a direction of movement of the first end and prevent movement of the suture relative to the tissue in a direction opposite the direction of movement of the first end. The barbs on a second portion of the body between the second end of the suture and a second axial location on the body which is less than the distance from the second end to the first axial location permit movement of the suture through the tissue in a direction of movement of the second end and prevent movement of the suture relative to the tissue in a direction opposite the direction of movement of the second end. The method includes inserting the first end of the suture into tissue at an insertion point and then advancing the suture in a generally curvilinear path until the second axial location is at the point of insertion of the first end of the suture and the first end of the suture exits the tissue at an exit point, leaving a length of the first portion of the suture in the tissue. The second end of the suture is inserted into tissue at the insertion point of the first end of the suture. The suture is advanced in a generally curvilinear path distally from the first portion of the suture, until the second end of the suture exits the tissue at an exit point, leaving a length of the second portion of the suture in the tissue. The tissue is manually grouped along the body of the suture as desired. The amplitude of each curvilinear path is generally perpendicular to the resultant holding force exerted by the suture on the tissue.

Also according to the present invention, a method of placing a first single-directional barbed suture and a second single-directional barbed suture in bodily tissue is provided. The sutures each include an elongated body, one pointed end, and one trailing end, and a plurality of barbs extending from the periphery of the body. The barbs permit movement of the suture through the tissue in the direction of movement of the pointed end and prevent movement of the suture in a direction opposite the direction of movement of the pointed end. The method includes inserting the first end of the first suture into tissue at an insertion point and then advancing the suture in a generally curvilinear path until the pointed end of the first suture exits the tissue at an exit point, leaving a length of the body of the first suture in the tissue. The pointed end of the second suture is inserted into tissue at the insertion point of the first

suture, and the second suture is advanced in a generally curvilinear path until the pointed end of the second suture exits the tissue at an exit point, leaving a length of the body of the second suture in the tissue. The first and second sutures are tied together at the insertion point. Tissue is manually grouped and advanced along the body of each suture as desired. The amplitude of each curvilinear path is generally perpendicular to the resultant holding force
5 exerted by each suture on the tissue.

Further according to the present invention, another method of placing a single-directional barbed suture in bodily tissue is provided. The suture includes an elongated body, one pointed end, one end terminating in an anchor, and a plurality of barbs extending from the periphery of the body. The anchor extends outside the periphery of the body to a greater degree than the barbs. The barbs permit movement of the suture through the tissue in the direction
10 of movement of the pointed end and prevent movement of the suture in a direction opposite the direction of movement of the pointed end, while the anchor prevents movement of the suture in the direction of movement of the pointed end. The method includes making an incision in the tissue to define a face of the tissue, and inserting the pointed end of the suture in the face of the tissue. The pointed end of the suture is advanced through the tissue to an exit point. The anchor is placed in the incision. The pointed end of the suture is advanced through the tissue until the
15 anchor achieves adequate holding strength in the tissue to resist further movement in the tissue, leaving the anchor embedded in the tissue.

Yet further according to the present invention, a method for joining two ends of severed internal tissue to allow tissue healing and regrowth together of the two ends of the internal tissue in vivo using a single-directional barbed suture is provided. The suture includes an elongated body, one pointed end, one end terminating in an anchor,
20 and a plurality of barbs extending from the periphery of the body. The anchor extends outside the periphery of the body to a greater degree than the barbs. The barbs permit movement of the suture through the tissue in the direction of movement of the pointed end and prevent movement of the suture in a direction opposite the direction of movement of the pointed end, while the anchor prevents movement of the suture in the direction of movement of the pointed end. The method includes inserting the pointed end of the suture into a first end of the internal tissue and
25 pushing the pointed end through the internal tissue along a curvilinear path, proceeding away from the first end and farther into the tissue. The pointed end of the suture is gripped and pulled out of the internal tissue to draw the anchor proximate to the first end of the tissue. The pointed end of the suture is pushed along the periphery of the internal tissue adjacent the exit point. The pointed end is pushed along the curvilinear path and then returns along the path to the first end, and exiting from the first end of the tissue. The pointed end is inserted into an opposing, second end of
30 tissue, and is pushed along a curvilinear path, proceeding away from the second end and farther into the tissue, then returning to the second end, and exiting from the second end of the tissue. The pointed end is inserted into the first end of tissue, pushing the pointed end along a curvilinear path, proceeding away from the second end and farther into the tissue, then returning toward the first end and exiting the tissue.

Brief Description of the Drawings

35 For a more complete understanding of the present invention, reference should now be had to the embodiments shown in the accompanying drawings and described below. In the drawings:

FIG. 1 is a perspective view of an embodiment of a barbed suture with an anchor for use according to the methods of the present invention.

FIGS. 2-11 are end views of embodiments of barbed sutures with anchors according to the present invention.

FIGS. 12-20 are elevation views of embodiments of barbed sutures with anchors according to the present invention.

FIG. 21 is an elevation view of a conventional means for affixing a suture to an attachment.

FIGS. 22 and 23 are elevation views of means for affixing sutures to anchors in accordance with the present invention.

FIGS. 24 and 25 are elevation views of a suture having a looped end according to the present invention.

FIGS. 26 and 27 are plan views of embodiments of methods according to the present invention for joining two sides of an open wound in tissue.

FIGS. 28 and 29 are plan views of embodiments of methods according to the present invention for joining two sides of an open wound in tissue

FIGS. 30 and 31 are plan views of embodiments of methods according to the present invention for inverting a surface wound in tissue.

FIGS. 32-39B are plan views of additional embodiments of methods according to the present invention for joining two sides of an open wound in tissue.

FIGS. 40 and 41 are plan views of conventional methods for positioning tissue.

FIGS. 42-45 are plan views of embodiments of methods according to the present invention for positioning tissue relative to a barbed suture disposed in the tissue.

FIGS. 46-48 are section views of embodiments of methods according to the present invention.

FIGS. 49 and 50 are plan views of further embodiments of methods according to the present invention for positioning tissue along a barbed suture disposed in the tissue.

FIGS. 51A-51C are plan views of an embodiment according to the present invention for joining two ends of a severed tendon.

FIGS. 52-55 are plan views of embodiments according to the present invention for performing an anastomosis procedure.

FIG. 56 is a detail view of an embodiment according to the present invention of a barb configuration.

FIG. 57 is a plan view of an example performed according to the present invention for joining two sides of an open wound in tissue.

FIG. 58 is a plan view of an example performed according to a conventional method for joining two sides of an open wound in tissue.

Description

As used herein, the term "wound" means a surgical incision, cut, laceration, severed tissue or accidental wound in human skin or other bodily tissue, or other condition where suturing, stapling, or the use of another tissue connecting device might be required.

As used herein, the term "tissue" includes tissues such as skin, bone, muscle, organs, and other soft tissue such as tendons, ligaments and muscle.

Certain other terminology is used herein for convenience only and is not to be taken as a limitation on the invention. For example, words such as "upper," "lower," "left," "right," "horizontal," "vertical," "inward," "outward," "upward," and "downward" merely describe the configuration shown in the figures. It is understood that the components may be oriented in any direction and the terminology, therefore, should be understood as encompassing such variations unless specified otherwise.

Barbed sutures and placement methods suitable for use according to the methods of the present invention are described in U.S. Patent No. 5,342,376, entitled "Inserting Device for a Barbed Tissue Connector", U.S. Patent No. 5,931,855, entitled "Surgical Methods Using One-Way Suture", U.S. Patent No. 6,241,747, entitled "Barbed Bodily Tissue Connector", U.S. Patent No. 6,599,310, entitled "Suture Method", U.S. Patent Application No. 10/065,256, entitled "Suture Method", U.S. Patent Application No. 10/065,278, entitled "Barbed Suture in Combination with Surgical Needle", U.S. Patent Application No. 10/065,279, entitled "Barb Configurations for Barbed Sutures", and U.S. Patent Application No. 10/065,280, entitled "Barbed Sutures". The contents of U.S. Patent No. 5,342,376, U.S. Patent No. 5,931,855, U.S. Patent No. 6,241,747, U.S. Patent No. 6,599,310, U.S. Patent Application No. 10/065,256, U.S. Patent Application No. 10/065,278, U.S. Patent Application No. 10/065,279, and U.S. Patent Application No. 10/065,280 are hereby incorporated by reference.

Referring now to the drawings, wherein like numerals designate corresponding or similar elements throughout the several views, FIG. 1 is a perspective view of a single-directional barbed suture 90 having a suture body 92 with barbs 94 extending from around the periphery thereof, a pointed end 96, and an anchor 98 at the other end. The anchor 98 comprises a bar which extends radially outwardly of the suture body 92 in a plane substantially perpendicular to the longitudinal axis of the suture body 92, which generally gives the barbed suture 90 a "T" shape. Many other shapes and configurations of anchors are feasible, as shown in the embodiments in end view (with the suture body normal to and into the page) in FIGS. 2-11. Each of the anchors shown in FIGS. 2-11 have limbs which extend radially outwardly from the suture body 92 a greater distance than the barbs 94. The anchors 98 on the barbed sutures 100, 102, 104, 106 depicted in FIGS. 2-5, respectively, have one or a plurality of limbs 108 generally evenly spaced around the periphery at the end of the suture. The embodiments of the barbed sutures 110, 112, 114 shown in FIGS. 6-8 have anchors 98 including a plurality of limbs 108 which extend from only a portion of the periphery at the end of the suture body 92. FIGS. 9-11 show embodiments of the barbed sutures 116, 118, 120 wherein each of the respective limbs 122-123, 124-126, 127-130 are of different lengths.

FIGS. 12-20 are further embodiments of barbed sutures at one end. FIG. 12 shows a barbed suture 132 that has an anchor 134 having limbs 136 that are concave toward the other end of the suture. FIG. 13 shows a barbed suture 138 with an anchor 140 having limbs 142 that are concave away from the pointed end of the suture. FIG. 14 shows a barbed suture 144 with an anchor 146 as shown in FIG. 1, further including a plurality of segments 148 extending from the bar toward the other end of the suture. FIG. 15 shows a barbed suture 150 having a hemispherical anchor 152. FIG. 16 shows a barbed suture 154 having an anchor 156 that resembles a coneflower. FIG. 17 shows a barbed suture 158 having an anchor 160 formed by a loop of the body 92 that crosses itself to form a clip, wherein tissue may be received between the clip. FIG. 18 shows a barbed suture 162 having an anchor 164 formed by a hook of the suture body 92. FIG. 19 shows a barbed suture 166 having an anchor resembling an "M" wherein the body 92 of the suture extends from the middle leg of the "M". FIG. 20 shows a barbed suture 170 having a single barb 172, larger than the opposing barbs 94, extending towards the other end of the suture 170. As demonstrated by the variety of anchor designs of FIGS. 12-20, many anchor designs are possible for use with the barbed suture and within the scope of the present invention.

The anchors shown in FIGS. 1-20 may be integrally formed with the body 92 of the barbed suture or, alternatively, may be mounted to the end of the suture. FIGS. 21-23 demonstrate ways that the anchors may be affixed to the barbed sutures. FIG. 21 shows the anchor 172 of FIG. 20. The end of the anchor 172 has an axial bore 178. Teeth 176 are provided on the inside of the bore 178 and angled inwardly. The suture body 92 is inserted into the

bore 178 and the end of the anchor 172 is crimped around the suture body 92. FIG. 22 shows the anchor 172 including a plurality of spaced rings 182 on the end of the suture body 92. The end of the suture body 92 is inserted through the rings 182. Barbs 184 are provided on the suture body 92 that oppose the rings 182 and secure the suture body 92 in place by engaging the rings 182. FIG. 23 shows a connection 186 between the anchor 188 and barbed suture body 92 made with, for example, glue or heat.

FIG. 24 shows a suture 190 having a loop 192 at one end. Referring to FIG. 25, the suture 190 is placed in tissue 194 by passing the suture 190 through tissue 194 and then through the loop 192. Tissue 194 is trapped by the suture 190 and the loop 192 resulting in the suture 190 being anchored.

The anchors according to the present invention may be formed by stamping and drilling, injection molding, or a laser cutting system, or other method as selected by one of ordinary skill in the art. The anchors may be made of bio-absorbable material, or a material as selected by one of ordinary skill in the art.

Various bio-absorbable polymers include, but are not limited to, polydioxanone, polylactide, polyglycolide, polycaprolactone, and copolymers thereof. Commercially available examples are polydioxanone (sold as PDS II, a trade name used by Ethicon for selling surgical sutures), copolymer of about 67% glycolide and about 33% trimethylene carbonate (sold as MAXON®, a trademark registered to American Cyanamid for surgical sutures), and copolymer of about 75% glycolide and about 25% caprolactone (sold as MONOCRYL®, a trademark registered to Johnson & Johnson for sutures and suture needles). Barbed sutures made from such bio-absorbable materials are useful in a wide range of applications.

Additionally, anchors may be formed from a non-absorbable material, which may be a polymer. Such polymers include, but are not limited to, polypropylene, polyamide (also known as nylon), polyester (such as polyethylene terephthalate), polytetrafluoroethylene (such as expanded polytetrafluoroethylene, sold by Gore as GORE-TEX®), polyether-ester (such as polybutester, which is the condensation polymerization of dimethyl terephthalate, polytetramethylene ether glycol, polymers having ester units (such as polyglycolide), and 1,4-butanediol, and which is marketed by Davis & Geck and by U.S. Surgical, companies owned by Tyco, under the name NOVAFIL®, which is a trademark registered to American Cyanamid for surgical sutures), or polyurethane. Alternatively, the non-absorbable material may be metal (e.g., steel), metal alloys, natural fiber (e.g., silk, cotton, et cetera), and the like.

As used herein, the term wound means a surgical incision, cut, laceration, severed tissue, or accidental wound in human skin or other bodily tissue, or other condition where suturing, stapling or the use of another tissue connecting device might be required.

FIGS. 26-39B show a variety of methods of suture placement in tissue for approximating the sides of wounds or separated tissue according to several embodiments of the present invention. The methods of suture placement include one or more terminal J-stitches, S-stitches, or the like. A terminal J-stitch, S-stitch, or the like comprises a suture placement method wherein a portion of the end of the suture extends in a different direction relative to the adjacent portion of the suture. The relative direction of the end portion of the suture may be, for example, at least approximately 30 degrees from the projected path of the adjacent portion of the suture. For convenience herein, reference is made to J-stitches and S-stitches, but it is understood that suture placement may differ from J-stitches or S-stitches yet still be within the scope of the present invention. Placement of the suture according to the methods of the present invention may be done either by needles or insertion devices as discussed below. Placement in such patterns may be facilitated by manipulation of tissue in addition to or in place of

manipulation of the sharp pointed end of the suture. Tissue may be manually grouped and advanced along the suture in accordance with the present invention as described and shown herein.

Reference is sometimes made herein to pointed ends of a suture. The pointed ends of the suture may be straight or curved. In one embodiment, the pointed ends of the suture may be surgical needles secured at each end of the body of the suture so that the body extends between the shank ends of the two needles. The needles are preferably constructed of stainless steel or other surgical grade metal alloy. The needles may be secured to the suture body by means of adhesives, crimping, swaging, or the like, or the joint may be formed by heat shrinkable tubing. A detachable connection may also be employed such that the needles may be removed from the body of the suture by a sharp tug or pull or by cutting. The length of the needles is selected to serve the type of tissue being repaired so that the needles can be completely removed leaving the suture body in the desired position within the tissue.

In FIG. 26, the sides of a wound 250 in tissue 252 are approximated using two bi-directional barbed sutures 254, 256 having barbs 94. Throughout the figures, solid line sutures indicate the sutures are visible, dashed line sutures indicate the sutures are embedded in tissue, and dotted line sutures indicate an alternative embedded location for the suture. A first suture 254 is positioned using a suture method wherein the two ends are placed in the tissue using a terminal J-stitch 260, 262. A second suture 256 is positioned in the tissue using a suture method wherein the two ends are placed in the tissue using a terminal S-stitch 264, 266. The J-stitches 260, 262 and S-stitches 264, 266 are shown to be pointing in the direction of the other suture, or "inward," but could also be pointed outward in the alternative locations 260a, 262a, 264a, 266a depending on the application and preference of one of ordinary skill in the art. As an example showing the placement of a J-stitch, the end portion of the J-stitch 262 of the first suture 254, aligned along A, is positioned at angle θ from the projected path of the adjacent portion of the suture 254 B, and is shown to be about 90 degrees. As an example showing the placement of an S-stitch, the end portion of the S-stitch 266 of the second suture 256, aligned along C, is positioned at angle α from the projected path D of the adjacent portion of the suture 256, and is shown to be about 45 degrees. The J-stitch and S-stitch angles θ and α may be greater or less than shown and the suture is still considered to be in accordance with the present invention.

FIG. 27 shows single-directional barbed sutures 270, 272 approximating the sides of a wound 250. Each suture 270, 272 has an anchor 274, 276 and is placed in the tissue 252 using a method which ends with a terminal J-stitch 278 or S-stitch 280 at the opposite end. Alternative J-stitch or S-stitch positions 278a, 280a may be used. Anchors may be embedded in the tissue 252 as with the anchor 274 of a first suture 270 by making a small incision, or may be above the tissue as with the anchor 276 of a second suture 272. The sutures 270, 272 may be placed with a sharp pointed end such as a needle at the opposite, leading end of the suture from the anchors 274, 276. The anchors 274, 276 are shown schematically; it is understood that a variety of anchors is available as appropriate, as previously discussed.

For convenience in the remaining embodiments described herein, mostly J-stitches are shown. It should be understood, however, that in all embodiments shown herein that have a suture placed with a needle, S-stitches could replace any depicted J-stitches. In one method of grouping and advancing tissue along the suture body, the sharp pointed end of the suture exits the tissue prior to completing, for example, the J-stitch. Then the tissue is grouped and advanced along the suture body, and then the suture pointed end enters the tissue to complete the J-stitch.

FIGS. 28 and 29 show suture methods using an alpha stitch pattern using a bi-directional barbed suture 254 and a single direction suture 270, respectively, to close a wound 250. The suture method using the bi-directional barbed suture 254 of FIG. 29 has a J-stitch at each end that may be either downward 284, 286, upward 284a, 286a, or

a combination thereof. The suture method using the single direction suture of FIG. 29 has a J-stitch shown at its leading end that may be either downward 288 or upward 288a. A purse-string stitch is a surgical suture method used to repair excisions, such as in as appendectomy, where inverting the remaining tissue is desired. A purse-string stitch may be used according to the methods of the present invention with a bi-directional barbed suture 254 or a single
5 direction suture 270 as shown in FIGS. 30 and 31, respectively. The description of FIG. 28 applies to FIG. 30, and the description of FIG. 29 applies to FIG. 31.

FIGS. 32 and 33 show suture methods using a zig-zag pattern to approximate the sides of a wound 250 with a bi-directional barbed suture 254 and a single-directional barbed suture 270 with an anchor 274, respectively. As previously shown in FIG. 26 and as shown in FIG. 32, the terminal end path A of the end portion of the suture 254 in
10 the J-stitch 262 is at an angle from the projected suture path B of the adjacent portion of the suture. The J-stitch angle shown is about 135 degrees. It is understood that the angle may vary and still be considered a J-stitch.

FIGS. 34 and 35 show a suture method for approximating the sides of a wound using a bi-directional barbed suture 254 and a single direction barbed suture 270 with an anchor 274, respectively, placed in the tissue 252 in a sinusoidal pattern.

15 FIGS. 36 and 37 show a bi-directional barbed suture 254 and a single direction barbed suture 270 with an anchor 274, respectively, placed in the tissue 252 in a corkscrew pattern.

With respect to the bi-directional suture 254 of FIGS. 32, 34, and 36, the suturing begins at an intermediate point between the ends of the wound and proceeds in both directions. In the zig-zag and sinusoidal patterns of FIGS. 32 and 34, respectively, the central portion of the suture 254, where the barbs 94 change direction, could also be
20 located at one end of the wound, with both ends of the suture proceeding in the same direction along the wound in separate patterns which are mirror images of one another. Both ends of the suture could then have a J-stitch or S-stitch at the same end of the wound. The J-stitches of FIGS. 32, 34, and 36 may be inward 260, 262, outward 260a, 262a, or a combination thereof. The J-stitches of FIGS. 33, 35, and 37 may be inward 278 or outward 278a. Further, the suture 270 shown in FIGS. 33 and 35 could double back in a mirror image pattern to the end of the wound placing
25 the leading end near the anchor 274, and could have a J-stitch or S-stitch at that location.

The anchors 274 of FIGS. 33, 35, and 37 are shown as contacting the surface of the tissue 252. Another method according to the present invention allows placement of the anchor 274 below the surface of the tissue as shown in FIGS. 38A and 38B.

As shown in FIG. 38A, a sharp pointed end of the suture 270, for example, a needle 280, is at the leading
30 end of a single-directional barbed suture 270 and is inserted into a face 288 of a wound 250. As the suture 270 is pulled through the tissue by the needle 280, the anchor 274 will abut the face of the wound 288. As the suture is pulled to approximate the wound, the anchor 274 will move until it meets resistance in the tissue 252. The tissue 252 generally comprises layers that are parallel to the surface of the tissue. Depending on the shape of the anchor 274, the anchor 274 may be expected to move between the layers and past the face 288 of the wound 250, embedding into the
35 adjacent tissue, arriving in a position spaced from the face 288 of the wound 250 as shown in FIG. 38B. Referring to FIG. 38A, in one embodiment, as selected by one of ordinary skill in the art the distance E from the end of the wound to the anchor 74 may be approximately the same as the distance between "bites," or the distance F from the face 288 of the wound to the peak 291 of the pattern.

Another suture method using a single directional barbed suture wherein anchors are embedded in tissue is
40 used for approximating a small wound, as shown in FIGS. 39A and 39B. In FIG. 39A, the needle 280 at the leading

end of a single-directional barbed suture 270 is inserted into the face 288 of a wound 250. Similarly to the method shown in FIGS. 38A and 38B, as the suture 270 is pulled by the needle 280, the anchor 274 will abut the face 288 of the wound 250. As the suture is pulled to approximate the sides of the wound 250, the anchor will move into the tissue 252 until it meets resistance in the tissue 252. In FIG. 39B, the anchor is shown to have moved into final
5 position spaced from the wound face 288. The placement of the suture 270 may form a loop, and the leading end may be placed as a J-stitch with alternative configurations 278, 278a.

FIGS. 40-50 show suture method according to the present invention wherein barbed sutures are placed to position tissue where there is no wound and the sutures are below the surface of the tissue, such as in cosmetic surgery. FIGS. 40 and 41 show the placement conventional, non-barbed sutures in tissue for providing lift. The
10 method of FIG. 40 uses one suture 300 with one knot 302 at the top and an exit/entry point 304 at the bottom. The knot is tightened to adjust the tissue 252 to the desired amount of lift. The method of FIG. 41 uses two sutures 306, 308 with one knot 310 at the top and another knot 312 at the bottom. The knots are tightened to provide the desired amount of lift to the tissue 252. The force sufficient to provide tissue lift is applied at the knots 302, 310, 312, and the load on the tissue 252 is concentrated at the top knots 302, 310 and bottom knot 312 or low point 304 of the sutures.

FIG. 42 shows a suture method according to the present invention wherein bi-directional barbed sutures 254, 256 are placed substantially parallel to one another and having J-stitches 260, 262, 264, 266 at each end that are directed toward the adjacent suture, or inward. FIG. 43 shows a similar suture method using two parallel bi-directional barbed sutures 254, 256 with the J-stitches 260a, 262a, 264a, 266a directed outwardly. FIG. 44 shows a
15 bi-directional barbed suture 254 with terminal J-stitches 314, 316 extending in opposite directions. Once the sutures 254, 256 are placed, the tissue may be manually advanced along each suture to be grouped as desired by the surgeon for a certain amount of tissue lift. Unlike the conventional methods of FIGS. 40 and 41, the resistance provided by the barbed sutures is distributed along the length of the suture.

FIG. 45 shows an embedded single-directional barbed suture 270 having an anchor 274 and a pointed end 320 positioned below the surface of the tissue 252 and terminating in a J-stitch 278. Optionally the J-stitch 278 may
20 be oriented differently or omitted altogether.

One method of placing a single-directional barbed suture 270 below the surface of tissue 252 is with an insertion device. Insertion device designs include straight, curved, and corkscrew. One such method of using an insertion device 322 is shown in FIG. 46. The insertion device 322 may include a straight or curved tube 324, a leading end 326, a trailing end 328, and a handle 330 for ease of use. Some nonlinear suture installations may be
30 performed with a straight tube by manipulation of tissue rather than with a curved tube. The pointed end 320 of the suture 270 may extend from the leading end 326 of the insertion device 322 or from an opening (not shown) in the side of the insertion device 322. At least one barb 94 on the suture 270 must extend through the opening at the leading end 326 or through the opening at the side of the insertion device. Alternatively, an anchor 274 could extend through the opening at the leading end 326 or through the opening at the side of the insertion device. The insertion
35 device 322 is advanced through the epidermis 332 and into subcutaneous tissue 334. When in the desired position, the insertion device 322 is withdrawn by the trailing end 328, and the pointed end 320 and barbs 94 of the suture 270 engage in the subcutaneous tissue 334, leaving the suture 270 in place to restrict movement in one direction as shown in FIG. 48. The anchor 274 is also embedded, restricting movement in the other direction.

Another method of placing a single-directional barbed suture 270 with an insertion device is shown in FIG.
40 48. The insertion device 340 has a straight or curved tube 342, a leading end 344, a trailing end 346, and a

reciprocating plunger 348. The anchor 274 is disposed in the tube 342 adjacent the leading end 344 of the insertion device 340. The insertion device 340 is advanced through the epidermis 330 and into the subcutaneous tissue 334. When in the desired position, the plunger 348 is depressed until the anchor 274 is expelled from the tube 342 and into the subcutaneous tissue 334. As the insertion device 340 is withdrawn from the trailing end 346, the anchor 274
5 engages in the tissue to restrict movement in one direction. The barbs 94 also engage of the subcutaneous tissue 334, restricting movement in the opposite direction.

The anchor 274 may be any design that fits within the insertion device, and may include collapsing designs that are collapsed while within the insertion device tube and expand when released. A "T" shape design is shown in the figures for convenience, and may be used when configured to fold along the direction of the insertion device tube.
10 Further, the methods illustrated in FIGS. 45-48 and described above may also be used to place single-directional barbed sutures with an insertion device to approximate the sides of a wound, as shown in FIG. 27.

FIG. 49 shows placement of five bi-directional barbed sutures 380, 400-403 using methods for cosmetic lifts for the brow, face, and neck according to the present invention. Each of the five bi-directional barbed sutures 380, 400-403 shown may be placed, in one embodiment, using a straight needle at each end. For a brow lift, the ends of
15 the suture 380 forming an inverted "U" or "V" shape, or variations thereof, enter at the same insertion point 382, generally superior to the hairline (or where the hairline would be expected). Sutures 400-403 may be placed with the ends extending in generally opposite directions starting from an insertion point 404-407 that may generally be superior to the expected hairline and exiting distally. In all methods, a side-to-side motion with the needle is used, in one embodiment without exiting the tissue until terminating, for placing the suture in a sinusoidal pattern. The
20 sinusoidal pattern may have greater or lesser amplitudes and frequencies than those shown in FIG. 49 and be within the scope of the present invention. As an alternative to bi-directional barbed sutures 380, 400-403, single-directional barbed sutures could be used for each portion 384, 386, 408, 410-416 of the respective sutures and their ends tied at the insertion points 382, 404-407 to the adjacent suture. Further, there may be generally straight portions of placed suture between the curvilinear portions and exit points. Following placement of a suture, tissue is advanced and
25 grouped along the body of the suture for providing lift and tissue support.

Placement of a suture in a sinusoidal pattern increases the suture's "shock-absorbing" capability and provides multiple opportunities for the suture to elongate or straighten and prevent shifted or repositioned tissue from relapsing (moving toward its original position). The amplitude of the curvilinear pattern is generally perpendicular to the direction of the resultant holding force of the suture, which is generally along the axis of the curvilinear pattern. An
30 example amplitude is shown at G in FIG. 49 and an example resultant holding force is shown at H. Pulling of the tissue may cause the tissue to relapse more than with straight-placed sutures, but there may be less breakage of the sinusoidally placed sutures because of the flexure provided by the sinusoidal pattern. The sinusoidal pattern may permit larger or tighter lifts as compared to the same number and size of sutures that are linearly placed. The sinusoidal pattern may also allow the use of fewer and bigger sutures, which may be desirable when the patient does
35 not want to be sedated.

For the browlift sutures 380, 400 and other lifts on the forehead, the portion 384, 386, 408 of the suture in the forehead engages just above muscle, frontalis, in subepidermal tissue. Subepidermal tissue includes the papillary dermis, reticular dermis, and subcutaneous tissue. The portions 410-413 of the sutures 400-403 extending into the scalp engage the galea aponeurotica and subepidermal tissue.

In general, for the sutures 401-403 in the face and neck, the anterior portions 414-416 engage just above muscle, platysma, but are slightly more superficial in the cheek or near the nose, and in subepidermal tissue. In particular, the anterior portion 414 of the facelift suture 401 in the upper face extends toward the nasolabial fold 418, engaging the subepidermal tissue, superficial muscular aponeurotic system, or both.

5 Specifically with respect to the facelift suture 402 in the cheek, the insertion point 406 is approximately at the posterior mandibular angle. The first end 412 of the suture is pushed posteriorly through subepidermal tissue, the superficial aponeurotic system, or combinations thereof along a path approximately parallel to the mandibular border, exiting distally. The second end 415 of the suture is pushed anteriorly through subepidermal tissue, the superficial aponeurotic system, or combinations thereof along a path approximately parallel to the mandibular border, also
10 exiting distally.

For the surgical procedure comprising a neck lift, the insertion point 407 of the barbed suture 403 is approximately at the upper sternomastoid muscle. The first end 413 of the suture is pushed posteriorly through subepidermal tissue, the superficial aponeurotic system, or combinations thereof along a path approximately parallel to the mandibular border, exiting distally. The second end 416 of the suture is pushed anteriorly through
15 subepidermal tissue, the superficial aponeurotic system, or combinations thereof along a path approximately parallel to the mandibular border, also exiting distally.

Additional cosmetic surgery applications may be performed within the scope of the present invention. For example, thigh lifts and breast lifts may be performed. In a thigh lift the insertion point is generally at the inguinal crease. The first end of the suture is pushed cranially through subepidermal tissue until the first end of the suture
20 extends out of the tissue, and the second end of the suture is pushed caudally through subepidermal tissue until the second end of the suture extends out of the tissue on the thigh. The thigh tissue is then advanced and grouped along the body of the suture for providing lift and tissue support.

In a breast lift, the insertion point is at the upper aspect of the breast curvature. The first end of the suture is pushed through subcutaneous tissue, dermal tissue, and pectoralis muscle until extending out of the tissue at an exit
25 point on the upper portion of the breast. The second end of the suture is pushed caudally through fibrous and fatty tissues until the second end of the suture extends out of the tissue at an exit point along the anterior aspect or the lower curvature of the breast. The breast tissue is then advanced and grouped along the body of the suture for providing lift and tissue support.

FIG. 50 shows suture methods for cosmetic surgery applications using single-directional barbed sutures 430-435 with anchors 436-441 according to the present invention. These suture methods may optionally include a terminal J-stitch or S-stitch (not shown), and may be placed with an insertion device 322, 340 as shown in FIGS. 46-49 or with a needle. For example, one suture 434 along the jaw line is shown as terminating at its pointed end with an S-stitch. Another suture 433 in the upper face is shown having a curvilinear pattern similar to those of FIG. 49. Although a schematic "T" shape anchor 436-441 is shown, the anchor may be any design as described herein and
35 selected by the surgeon depending on the application. The anchors may be embedded either by use of an insertion device or by making a small incision. Another suture 442 is shown in the forehead and is placed with curves at the ends 444, 445, including a J-stitch proximate to the end 445 at the brow. Applications to brow, face, neck, thigh, and breast are similar to and correspond to those detailed above for bi-directional sutures in similar locations with respect to the tissue engaged. Following placement of the suture, tissue is advanced and grouped along the body of the suture
40 for providing lift and tissue support. As a variation to grouping and advancing the tissue along the suture after

completing the desired pattern, such as a J-stitch, the suture pointed end may exit the tissue prior to completing the J-stitch, then the tissue may be grouped and advanced, and then the J-stitch may be completed.

FIGS. 51A-51C show the use of a single-directional barbed suture 270 for repair of two parts of a severed tendon 450, 452, referred to for convenience as the left part 450 and right part 452. As shown in FIG. 51A, the suture enters the end 454 of the left part 450 and follows a curvilinear path to an exit point 456. The anchor 274 abuts the end 454 of the left part 450. The suture enters again at a point 458 adjacent to the exit point 456 and continues to form a loop on the curvilinear path until exiting at point 460 and then entering at point 462. The suture completes the loop and exits through the end 454 of the left part 450 then passes through the end 464 of the right part 452. As shown in FIG. 51B, the suture follows the selected curvilinear path advancing through the tendon 252 away from the end 464 by exiting at points 466, 468, 470 and entering at points 472, 474, 476, and then returns back to the end 464 by exiting the tendon through points 478, 480, 482 and entering through points 484, 486, 488. As shown in FIG. 51C, the suture then again enters the end 454 of the left part 450, follows the selected curvilinear path exiting the tendon at points 490, 492, 494, 496 and entering at points 498, 500, 502, 504 until making a final exit 506 from the periphery of the tendon.

Also according to the present invention, methods are provided for joining the ends of two portions of a tube, a tubular structure, or a hollow organ within the body using a barbed suture, such as the ends of a blood vessel in an anastomosis procedure. As used herein, the term "tube" includes but is not limited to, blood vessels, the large and small intestine, ducts, and the like. As shown in FIGs. 52-55, the ends of the tube may be first cut at an angle prior to joining for promoting a more effective attachment.

Referring to FIG. 52, a method is shown for joining the ends of a tube using a single-directional barbed suture 270 having an anchor 274. The pointed end 280 of the barbed suture 270, which in the embodiment shown comprises a needle, is inserted through the wall and into the interior of a first end 550 of the tube. The pointed end of the suture 270 is then inserted from the interior of the tube through the wall of a second end 552 of the tube. The suture 270 is pulled through the walls of the tube until the anchor 274 contacts the outer surface of the wall of the first end 550 of the tube for drawing the two ends 550, 552 of the tube together. The suture 270 is then again inserted through the wall of the first end 550 of the tube at a point 554 circumferentially spaced from the initial insertion point 556. The steps are repeated for advancing the suture 270 around the tube. After the last bite, the suture pattern may be completed with a terminal J-stitch or S-stitch.

FIG. 53 shows a method of using a bi-directional barbed suture 254 for joining the ends 550, 552 of a tube using a similar suture pattern as the method shown in FIG. 52. Beginning at an initial insertion point 558, an end of a first portion 560 of the suture 254 is inserted through the wall and into the interior of a first end 552 of the tube. The end of the first portion 560 of the suture 254 is then inserted from the interior of the tube through the wall of a second end 550 of the tube. The first portion 560 of the suture 254 may be pulled through the walls of the tube until the opposed barbs on a second portion 562 of the suture 254 contact the outer surface of the wall of the first end 552 of the tube for drawing the two ends 550, 552 of the tube together. The end of the first portion 560 of the suture 254 is inserted through the wall and into the interior of the first end 552 of the tube at a point 564 circumferentially spaced in a first direction from the initial insertion point 558. The end of the second portion 562 of the suture 254 is inserted through the wall and into the interior of the second end 550 of the tube at a point 566 circumferentially spaced from the exit point 568 of the end of the first portion 560 of the suture 254. The end of the second portion 562 of the suture 254 is then inserted from the interior of the tube through the wall of the first end 552 of the tube at a point 570

circumferentially spaced in a second direction from the initial insertion point 558. These steps are repeated for advancing each end of the barbed suture 254 around the tube. After the last bite, the suture pattern may be completed with a terminal J-stitch or S-stitch at each end.

FIG. 54 shows another method of using a bi-directional barbed suture 254 for joining the ends 550, 552 of a
5 bodily tube. Beginning at an initial insertion point 572, an end of a first portion 560 of the suture 254 is inserted through the wall of a first end 552 of the tube. The end of the first portion 560 of the suture 254 is then inserted from the interior of the tube through the wall of a second end 550 of the tube. The first portion 560 of the suture 254 may be pulled through the walls of the tube until the opposed barbs on a second portion 562 of the suture 254 contact the outer surface of the wall of the first end 552 of the tube for drawing the two ends 550, 552 of the tube together. The
10 end of the first portion 560 of the suture 254 is inserted through the wall and into the interior of the first end 552 of the tube at a point 574 circumferentially spaced in a first direction from the initial insertion point 572. The end of the second portion 562 of the suture 254 is inserted through the wall of the first end 552 of the tube at a point 576 adjacent the initial insertion point 572 of the first portion 560 of the suture 254, which practically functions as the same point of insertion. The end of the second portion 562 of the suture 254 is then inserted from the interior of the
15 tube through the wall of the second end 550 of the tube at a point 578 circumferentially spaced from the first exit point 580 of the end of the first portion 560 of the suture 254. The end of the second portion 562 of the suture 254 is then inserted through the wall of the first end 552 of the tube at a point 582 circumferentially spaced in a second direction from the initial insertion point 576. These steps are repeated for advancing each end of the barbed suture 254 around the tube. After the last bite, the suture pattern may be completed with a terminal J-stitch or S-stitch at
20 each end. Alternatively, the suture pattern may continue as described until the ends of the suture cross one another, as shown in FIG. 55. Even then the suture pattern may be completed with a terminal J-stitch or S-stitch, if desired.

In the method for joining the ends of a tube according to the present invention, the path of insertion of the end of the suture through the tube may include a longitudinal component as the suture is advanced through the tissue of the tube. Using this technique, more of the length of the suture is placed in the tissue of the tube, which may result
25 in better holding strength. Additionally, effective joining of the ends of a tube within the body can be achieved using the methods described herein regardless of where the barbed suture initially enters the tube along the periphery of the free end.

It is understood that although the methods of joining two ends of a bodily tube is shown and described, the present invention is not so limited. In particular, the methods according to the present invention may include a
30 procedure wherein a portion of tube is grafted between the ends of the original tube. This is a procedure particularly used in coronary artery bypass grafting, or CABG. The grafting procedure is similar to the methods described herein except that the ends of the graft are attached to the ends of the tube using the suture methods described above.

The invention is further illustrated by the following non-limiting example.

EXAMPLE

35 Testing was performed comparing the tissue holding capacity of a bi-directional barbed suture placed in tissue with a J-stitch at each end with a conventional knotted suture. Two different barb geometry designs (A and B) of a bi-directional barbed suture were fabricated from polydioxanone (PDO), size 0. Each suture was 7 inches long and included 78 barbs, equally divided into two opposing segments, in the middle 3 inches. The spirality of Design A was 12.8 degrees, and the spirality of Design B was 12.4 degrees. The average straight-pull tensile strength of each
40 design was measured using ten samples. Using an Optem Zoom microscope (made by Thales Optem Inc. of Fairport,

New York) with an attached video camera, the barb geometries were characterized by four different parameters: cut angle (ϕ); cut depth (D_c); calculated cut length (L_c); and the distance between cuts (FIG. 56).

The straight-pull tensile strengths and barbed geometries of the barb sutures were determined to be as shown in Table 1.

5

TABLE 1

<u>Parameters</u>	<u>Design A</u>	<u>Design B</u>
Tensile strength (lb.)	7.12 \pm 0.25	9.89 \pm 0.34
Cut angle, ϕ ($^\circ$)	152.3 \pm 0.8	162.2 \pm 2.2
Cut depth, D_c (mm)	0.25 \pm 0.01	0.12 \pm 0.02
Cut length, L_c (mm)	0.54 \pm 0.02	0.38 \pm 0.04
Distance between cuts (mm)	0.82 \pm 0.01	0.91 \pm 0.04

Referring to FIGS. 57 and 58, a full-thickness, 3-cm incision was created in the distal jejunum 530 of a cadaveric pig perpendicular to its length. The jejunal segment measured about 10 cm in outer circumference and 5 mm in thickness. Each wound 538 was excised so that it was centered on a 4 cm by 15 cm piece of tissue. The wound 538 was closed with either a barbed suture 254 including the two Designs A and B as shown in FIG. 57, or control PDS II (polydioxanone) suture 540 as shown in FIG. 58, all of size 0, using a running "over-and-over" technique. Suture strands, in the serosa 542 and mucosa 544, engaged but did not perforate the mucosal layer. A knot (5 throws) anchored each end of the control suture, whereas the barbed suture 254 was finished with and without a J-stitch bite through adjacent tissue. Bite size (4 mm), distance between bites (5 mm), and number of crosses of the incision (11) were equivalent in all suture types. Wound edges were cut such that only the sutures held the two halves together. Ten sutured tissue specimens of each suture type were tested on a Test Resources Universal Tester, model 200Q (made by DDL of Eden Prairie, Minnesota), with a 250 lb. load cell, a 5 cm gauge length, and a crosshead speed of 5 cm/sec. Each specimen was stretched to failure, wherein the sutures tore through the tissue to the wound and the two pieces of tissue separated, and the maximum load was recorded.

20

The average peak forces required to separate the pig intestinal wounds are shown in Table 2:

TABLE 2

<u>Sutures, size 0</u>	<u>Tissue Holding Capacity (lb.)</u>
Barbed PDO, A with terminal J-Stitch	7.64 \pm 1.39
Barbed PDO, A without terminal J-Stitch	4.53 \pm 1.07
Barbed PDO, B with terminal J-Stitch	8.40 \pm 1.83
Control PDS II	6.61 \pm 2.02

By comparison with the U.S. Pharmacopoeia minimum knot-pull tensile strength requirement of size 0 absorbable sutures, 8.60 lb., the tensile strength of barbed PDO Design A, appears inferior. However, the Design A wound holding capacity using a terminal J-stitch compares favorably to that of the same-size control in the pig
5 intestinal model ($p=0.19$). Further, Design B with a terminal J-stitch not only exceeds the U.S. Pharmacopoeia requirement, but also demonstrates a trend toward higher mechanical performance than the conventional suture. The wound holding strength omitting the J-stitches and using Design A was inferior to the holding capacity of Design A with J-stitches. Some of this reduction may be the result of the shorter length of suture in the tissue with J-stitches omitted, but it is believed that most of the difference is the result of omitting the J-stitch configuration.

10 Although the present invention has been shown and described in considerable detail with respect to only a few exemplary embodiments thereof, it should be understood by those skilled in the art that we do not intend to limit the invention to the embodiments shown and described since various modifications, omissions and additions may be made to the disclosed embodiments without materially departing from the novel teachings and advantages of the invention, particularly in light of the foregoing teachings. For example, the barbed sutures with one or more J-
15 stitches and S-stitches and the single-directional sutures with anchors may be used in a wide variety of applications, including but not limited to Nissen funduplications, stabilization of bowel structures during laparoscopic surgery, appendectomy, Zenker's Diverticulum surgery, urinary bladder cystostomy, securing a replacement heart valve, securing external devices to tissue, and closing axial wounds in blood vessels. Accordingly, we intend to cover all such modifications, omission, additions and equivalents as may be included within the spirit and scope of the
20 invention.

We claim:

1. A barbed suture comprising:
 - an elongated body;
 - one pointed end;
 - a plurality of barbs extending from the periphery of the body, the barbs permitting movement of the
- 5 suture through the tissue in the direction of movement of the pointed end and preventing movement of the suture in a direction opposite the direction of movement of the pointed end; and
 - one end having an anchor including at least one arcuate limb extending outside the periphery of the
 - body to a greater degree than the barbs, the anchor preventing movement of the suture in the direction of
 - movement of the pointed end.
- 10 2. The barbed suture of claim 1, wherein the anchor has a plurality of arcuate limbs that are substantially evenly spaced around the body of the suture.
3. The barbed suture of claim 1, wherein the anchor has a plurality of arcuate limbs that are unevenly spaced around the body of the suture.
4. The barbed suture of claim 3, wherein each of the plurality of arcuate limbs is a different length.
- 15 5. The barbed suture of claim 1, wherein the plurality of arcuate limbs are curved in a concave direction relative to the body of the suture.
6. The barbed suture of claim 1, wherein the plurality of arcuate limbs are curved in a convex direction relative to the body of the suture.
7. The barbed suture of claim 1, wherein segments are attached to the arcuate limbs of the anchor.
- 20 8. The barbed suture of claim 1, wherein the anchor collapses to fit within a insertion device, the insertion device including a tubular element in which the suture is disposed, having an inside diameter smaller than the extended reach of the anchor.
9. The barbed suture of claim 1, wherein there is one arcuate limb that forms a hook with the open end facing the suture body.
- 25 10. The barbed suture of claim 1, wherein the arcuate limb forms a loop, with the limb crossing itself and there being an opening at the crossing into which tissue may be embedded.
11. The barbed suture of claim 1, wherein the one pointed end is a needle.
12. A barbed suture comprising:
 - an elongated body;
 - one pointed end;
 - a plurality of barbs extending from the periphery of the body, the barbs permitting movement of the
- 30 suture through the tissue in the direction of movement of the pointed end and preventing movement of the suture in a direction opposite the direction of movement of the pointed end; and
 - one end having an anchor including a bar perpendicular to body of the suture to form a T-
- 35 configuration extending outside the periphery of the body to a greater degree than the barbs, and further including segments mounted to the bar, the anchor preventing movement of the suture in the direction of movement of the pointed end.
13. The barbed suture of claim 12, wherein the one pointed end is a needle.
14. A barbed suture comprising:
 - an elongated body;
- 40

one pointed end;

a plurality of barbs extending from the periphery of the body, the barbs permitting movement of the suture through the tissue in the direction of movement of the pointed end and preventing movement of the suture in a direction opposite the direction of movement of the pointed end; and

5 one end having an anchor configured to resemble a harpoon end and extending outside the periphery of the body to a greater degree than the barbs, the anchor preventing movement of the suture in the direction of movement of the pointed end.

15. The barbed suture of claim 14, wherein the one pointed end is a needle.

16. A barbed suture comprising:

10 an elongated body;

one pointed end;

a plurality of barbs extending from the periphery of the body, the barbs permitting movement of the suture through the tissue in the direction of movement of the pointed end and preventing movement of the suture in a direction opposite the direction of movement of the pointed end; and

15 one end having a loop through which the elongated body may pass to secure tissue as an anchor, the anchor preventing movement of the suture in the direction of movement of the pointed end.

17. The barbed suture of claim 16, wherein the one pointed end is a needle.

18. A barbed suture comprising:

an elongated body;

20 one pointed end;

a plurality of barbs extending from the periphery of the body, the barbs permitting movement of the suture through the tissue in the direction of movement of the pointed end and preventing movement of the suture in a direction opposite the direction of movement of the pointed end; and

25 one end having an anchor configured to resemble an object selected from the group including an umbrella, a coneflower, and an "M", the anchor preventing movement of the suture in the direction of movement of the pointed end.

19. The barbed suture of claim 16, wherein the one pointed end is a needle.

20. A method of placing a barbed suture in bodily tissue, the suture including at least one pointed end and a central portion having barbs that allow movement of the suture in the direction of movement of the pointed end and

30 resist movement of the suture away from the direction of movement of the pointed end, the method comprising:

inserting the pointed end of the suture in the tissue;

advancing the suture through the tissue such that the central portion is disposed along a first path;

and

35 path,

wherein the second path forms an angle with the projected first path, had the suture remained on the first path, of at least approximately 30 degrees.

21. The method of claim 20, wherein the first path is substantially straight.

22. The method of claim 20, wherein the first path is substantially an alpha stitch.

40 23. The method of claim 20, wherein the first path substantially a purse-string stitch.

24. The method of claim 20, wherein the angle formed by the projected first path and the second path is at least approximately 60 degrees.
25. The method of claim 20, wherein the angle formed by the projected first path and the second path is at least approximately 90 degrees.
- 5 26. The method of claim 20, wherein the suture is a single-directional suture.
27. The barbed suture of claim 26, wherein the one pointed end is a needle.
28. The method of claim 20, wherein the suture is a bi-directional suture.
29. The barbed suture of claim 28, wherein the bi-directional suture has two pointed ends that are needles.
30. The method of claim 20, wherein the combined path of the first and second paths is selected from the group
10 including a J-stitch and an inverted J-stitch.
31. The method of claim 20, wherein the second path is selected from the group including an S-stitch and an inverted S-stitch.
32. A method of placing a barbed suture in bodily tissue to approximate tissue on each side of a wound, the suture including at least one pointed end and a central portion having barbs that allow movement of the suture in the
15 direction of movement of the pointed end and resist movement of the suture away from the direction of movement of the pointed end, the method comprising:
- inserting the pointed end of the suture in the tissue;
advancing the suture through the tissue along a first path;
deviating from the first path to follow a second path generally disposed laterally away from the
20 wound; and
deviating from the second path proximate to the at least one pointed end of the suture along a third path,
- wherein the third path forms an angle with the projected second path, had the suture remained on the second path, of at least approximately 30 degrees.
- 25 33. The method of claim 32, wherein the first path is substantially straight.
34. The method of claim 32, wherein the first path is substantially curvilinear.
35. The method of claim 32, wherein the first path is substantially sinusoidal.
36. The method of claim 32, wherein the first path is substantially a corkscrew pattern.
37. The method of claim 32, wherein the angle formed by the projected second path and the third path is at least
30 approximately 60 degrees.
38. The method of claim 32, wherein the angle formed by the projected second path and the third path is at least approximately 90 degrees.
39. The method of claim 32, wherein the suture is a single-directional suture.
40. The barbed suture of claim 39, wherein the one pointed end is a needle.
- 35 41. The method of claim 32, wherein the suture is a bi-directional suture.
42. The barbed suture of claim 41, wherein the bi-directional suture has two pointed ends that are needles.
43. The method of claim 32, wherein the combined path of the second and third paths is selected from the group including a J-stitch and an inverted J-stitch.
44. The method of claim 32, wherein the third path is selected from the group including an S-stitch and an
40 inverted S-stitch.

45. A method of placing a single-directional barbed suture in bodily tissue to approximate a wound, the suture including an elongated body, one pointed end, one end terminating in an anchor, and a plurality of barbs extending from the periphery of the body, the anchor extending outside the periphery of the body to a greater degree than the barbs, the barbs permitting movement of the suture through the tissue in the direction of movement of the pointed end
5 and preventing movement of the suture in a direction opposite the direction of movement of the pointed end, the anchor preventing movement of the suture in the direction of movement of the pointed end, the method comprising:
inserting the pointed end of the suture into one face of the wound; and
advancing the suture through the tissue until the anchor achieves adequate holding strength in the
tissue to resist further movement in the tissue,

10 wherein the anchor is embedded in the tissue.

46. The barbed suture of claim 45, wherein the one pointed end is a needle.

47. A method of placing a single-directional suture in tissue using an insertion device, the suture including an elongated body, one pointed end, one end terminating in an anchor, and a plurality of barbs extending from the periphery of the body, the anchor when extended extending outside the periphery of the body to a greater degree than
15 the barbs, the barbs permitting movement of the suture through the tissue in the direction of movement of the pointed end and preventing movement of the suture in a direction opposite the direction of movement of the pointed end, the anchor preventing movement of the suture in the direction of movement of the pointed end, the insertion device including a tubular element in which the suture body is at least in part initially disposed and having leading and trailing ends, the method comprising:

- 20 (a) inserting the pointed end of the suture and the leading end of the insertion device into the tissue at an insertion point;
(b) pushing the pointed end of the suture and the leading end of the insertion device through the tissue until reaching an endpoint;
(c) gripping and pulling the insertion device at the trailing end to remove the insertion device; and
25 (d) manually grouping and advancing the tissue along the body of the suture as desired.

48. The method of claim 47, wherein the suture anchor, body, and pointed end are embedded in the tissue.

49. The method of claim 47, wherein the suture pointed end extends outside of the tissue at the endpoint.

50. The method of claim 47, wherein the pointed end of the suture and at least one barb initially extend outside of the insertion device leading end.

30 51. The method of claim 47, wherein the pointed end of the suture and at least one barb initially extend outside an opening in the side of the insertion device spaced from the leading end of the insertion device.

52. The barbed suture of claim 47, wherein the one pointed end is a needle.

53. A method of placing a single-directional suture in tissue using an insertion device, the suture including an elongated body, one pointed end, one end terminating in an anchor, and a plurality of barbs extending from the
35 periphery of the body, the anchor when extended extending outside the periphery of the body to a greater degree than the barbs, the barbs permitting movement of the suture through the tissue in the direction of movement of the pointed end and preventing movement of the suture in a direction opposite the direction of movement of the pointed end, the anchor preventing movement of the suture in the direction of movement of the pointed end, the insertion device including a tubular element having leading and trailing ends, the method comprising:

- (a) inserting the leading end of the insertion device at an insertion point and through the tissue until reaching an endpoint;
 - (b) inserting a leading end of the suture into the insertion device at least until the trailing end of the suture is within the insertion device;
 - 5 (c) inserting a plunger into the trailing end of the insertion device to abut the trailing end of the suture;
 - (d) depressing the plunger to push the leading end of the suture out of the insertion device;
 - (e) gripping and pulling the insertion device at the trailing end to remove the insertion device, leaving the suture in place; and
 - (f) manually grouping and advancing the tissue along the body of the suture as desired.
- 10 54. The method of claim 53, wherein the leading end of the suture is the pointed end and the trailing end of the suture is the anchor.
55. The method of claim 54, wherein the one pointed end is a needle.
56. The method of claim 53, wherein the leading end of the suture is the anchor and the trailing end of the suture is the pointed end.
- 15 57. The method of claim 53, wherein after inserting the suture into the insertion device the pointed end of the suture and at least one barb extend outside of the insertion device leading end.
58. The method of claim 53, wherein after inserting the suture into the insertion device the pointed end of the suture and at least one barb extend outside an opening in the side of the insertion device spaced from the leading end of the insertion device.
- 20 59. A method of performing a surgical procedure using a barbed suture including an elongated body, first and second sharp pointed distal ends for penetrating tissue, and a plurality of barbs extending from the periphery of the body, the barbs on a first portion of the body between the first end of the suture and a first axial location on the body for permitting movement of the suture through the tissue in a direction of movement of the first end and preventing movement of the suture relative to the tissue in a direction opposite the direction of movement of the first end, and the
- 25 barbs on a second portion of the body between the second end of the suture and a second axial location on the body which is less than the distance from the second end to the first axial location permitting movement of the suture through the tissue in a direction of movement of the second end and preventing movement of the suture relative to the tissue in a direction opposite the direction of movement of the second end, and using an insertion device including a tubular element, the insertion device having leading and trailing ends, the method comprising:
- 30 (a) inserting the leading end of the insertion device at an insertion point in the tissue;
 - (b) advancing the leading end of the insertion device through tissue until reaching a selected point;
 - (c) inserting the first pointed end of the suture into the insertion device at least until one barb extends out of the insertion device;
 - (d) gripping and pulling the insertion device at the trailing end to remove the insertion device, leaving
 - 35 the full length of the suture in place in the tissue; and
 - (e) manually grouping and advancing the tissue along the body of the suture as desired.
60. The method of claim 59, wherein after inserting the suture into the insertion device the pointed end of the suture and at least one barb extend outside of the insertion device leading end.

61. The method of claim 59, wherein after inserting the suture into the insertion device the pointed end of the suture and at least one barb extend outside an opening in the side of the insertion device spaced from the leading end of the insertion device.
62. The barbed suture of claim 59, wherein the first and second sharp pointed distal ends are needles.
- 5 63. A method of performing a surgical procedure using a barbed suture including an elongated body, first and second sharp pointed distal ends for penetrating tissue, and a plurality of barbs extending from the periphery of the body, the barbs on a first portion of the body between the first end of the suture and a first axial location on the body for permitting movement of the suture through the tissue in a direction of movement of the first end and preventing movement of the suture relative to the tissue in a direction opposite the direction of movement of the first end, and the
- 10 barbs on a second portion of the body between the second end of the suture and a second axial location on the body which is less than the distance from the second end to the first axial location permitting movement of the suture through the tissue in a direction of movement of the second end and preventing movement of the suture relative to the tissue in a direction opposite the direction of movement of the second end, the method comprising:
- (a) inserting the first end of the suture into tissue at an insertion point;
- 15 (b) advancing the suture in a generally curvilinear path until the second axial location is at the point of insertion of the first end of the suture and the first end of the suture exits the tissue at an exit point, leaving a length of the first portion of the suture in the tissue;
- (c) inserting the second end of the suture at the insertion point of the first end of the suture into tissue;
- (d) advancing the suture in a generally curvilinear path distally from the first portion of the suture, until
- 20 the second end of the suture exits the tissue at an exit point, leaving a length of the second portion of the suture in the tissue; and
- (e) manually grouping and advancing the tissue along the body of the suture as desired,
- wherein the amplitude of each curvilinear path is generally perpendicular to the resultant holding force exerted by the suture on the tissue.
- 25 64. The method of claim 63, wherein the curvilinear path is generally sinusoidal.
65. The method of claim 63, wherein the path further comprises a generally straight path following the curvilinear path, disposed between the curvilinear path and each exit point.
66. The method of claim 63, wherein the first and second sharp pointed distal ends are needles.
67. The method of claim 66, wherein the needles are straight needles.
- 30 68. The method of claim 63, wherein the first and second pointed ends do not exit the tissue until their respective paths are complete.
69. The method of claim 63, wherein at least one path terminates in a pattern selected from the group including a J-stitch, an inverted J-stitch, an S-stitch, and an inverted S-stitch.
70. The method of claim 63, wherein:
- 35 (a) the surgical procedure is a browlift and the insertion point is on a person's face approximately superior to the frontal hairline;
- (b) the first end of the suture is pushed through subepidermal tissue, galea aponeurotica, or a combination thereof, underneath the scalp and the exit point of the first end of the suture is on the scalp;
- (c) the second end of the suture is pushed through subepidermal tissue and the exit point of the second
- 40 end of the suture is proximate to the brow; and

- (d) the tissue is manually grouped and advanced along the second portion of the suture to provide the desired amount of lift.
71. The method of claim 70, wherein the insertion point is approximately superior to the frontal hairline.
72. The method of claim 70, wherein the insertion point is approximately at the midpoint between the brow and
5 the frontal hairline.
73. The method of claim 70, wherein the first and second sharp pointed distal ends are needles.
74. The method of claim 63, wherein:
- (a) the surgery procedure is a browlift and the insertion point is on a person's face approximately superior to the frontal hairline;
- 10 (b) the first end of the suture is pushed through subepidermal tissue and the exit point of the first end of the suture is proximate to the brow;
- (c) the second end of the suture is pushed through subepidermal tissue and the exit point of the second end of the suture is proximate to the brow and spaced from the exit point of the first end of the suture; and
- (d) the tissue is manually grouped and advanced along the first and second portions of the suture to
15 provide the desired amount of lift.
75. The method of claim 74, wherein the insertion point is approximately superior to the frontal hairline.
76. The method of claim 74, wherein the insertion point is approximately at the midpoint between the brow and the frontal hairline.
77. The method of claim 74, wherein the first and second sharp pointed distal ends are needles.
- 20 78. The method of claim 63, wherein:
- (a) the surgery procedure is a facelift and the insertion point is approximately superior to the temporal hairline;
- (b) the first end of the suture is pushed through subepidermal tissue, galea aponeurotica, or a combination thereof, to the exit point on the scalp;
- 25 (c) the second end of the suture is pushed through subepidermal tissue, the superficial muscular aponeurotic system, or combinations thereof, to the exit point proximate to the nasolabial fold; and
- (d) tissue is manually grouped and advanced along the second portion of the suture to provide the desired amount of lift.
79. The method of claim 78, wherein the first and second sharp pointed distal ends are needles.
- 30 80. The method of claim 63, wherein:
- (a) the surgery procedure is a facelift and the insertion point is approximately at the posterior mandibular angle;
- (b) the first end of the suture is pushed posteriorly through subepidermal tissue, the superficial aponeurotic system, or combinations thereof along a path approximately parallel to the mandibular border,
35 exiting distally;
- (c) the second end of the suture is pushed anteriorly through subepidermal tissue, the superficial aponeurotic system, or combinations thereof along a path approximately parallel to the mandibular border, exiting distally;
- (d) tissue is manually grouped and advanced along the second portion of the suture to provide the
40 desired amount of lift.

81. The method of claim 80, wherein the first and second sharp pointed distal ends are needles.
82. The method of claim 63, wherein:
- 5 (a) the surgery procedure is a neck lift and the insertion point is approximately at the upper sternomastoid muscle;
- (b) the first end of the suture is pushed posteriorly through subepidermal tissue, the superficial aponeurotic system, or combinations thereof along a path approximately parallel to the mandibular border, exiting distally;
- (c) the second end of the suture is pushed anteriorly through subepidermal tissue, the superficial aponeurotic system, or combinations thereof along a path approximately parallel to the mandibular border, exiting distally;
- 10 (d) tissue is manually grouped and advanced along the second portion of the suture to provide the desired amount of lift.
83. The method of claim 82, wherein the first and second sharp pointed distal ends are needles.
84. The method of claim 63, wherein:
- 15 (a) the surgery procedure is a thigh lift and the insertion point is generally at the inguinal crease;
- (b) the first end of the suture is pushed cranially through subepidermal tissue until the first end of the suture extends out of the tissue; and
- (c) the second end of the suture is pushed caudally through subepidermal tissue until the second end of the suture extends out of the tissue on the thigh.
- 20 85. The method of claim 84, wherein the first and second sharp pointed distal ends are needles.
86. The method of claim 63, wherein:
- (a) the surgery procedure is a breast lift and the insertion point is at the upper aspect of the breast curvature;
- (b) the first end of the suture is pushed through subcutaneous tissue, dermal tissue, and pectoralis muscle until extending out of the tissue at an exit point on the upper portion of the breast; and
- 25 (c) the second end of the suture is pushed caudally through fibrous and fatty tissues until the second end of the suture extends out of the tissue at an exit point along the anterior aspect or the lower curvature of the breast.
- wherein the first and second sharp pointed distal ends are needles.
- 30 87. The method of claim 86, wherein the first and second sharp pointed distal ends are needles.
88. A method of placing a first single-directional barbed suture and a second single-directional barbed suture in bodily tissue, the sutures each including an elongated body, one pointed end, and one trailing end, and a plurality of barbs extending from the periphery of the body, the barbs permitting movement of the suture through the tissue in the direction of movement of the pointed end and preventing movement of the suture in a direction opposite the direction
- 35 of movement of the pointed end, the method comprising:
- (a) inserting the first end of the first suture into tissue at an insertion point;
- (b) advancing the suture in a generally curvilinear path until the pointed end of the first suture exits the tissue at an exit point, leaving a length of the body of the first suture in the tissue;
- (c) inserting the pointed end of the second suture into tissue at the insertion point of the first suture;

- (d) advancing the second suture in a generally curvilinear path until the pointed end of the second suture exits the tissue at an exit point, leaving a length of the body of the second suture in the tissue;
- (e) tying the first and second suture together at the insertion point; and
- (f) manually grouping and advancing the tissue along the body of each suture as desired,

5 wherein the amplitude of each curvilinear path is generally perpendicular to the resultant holding force exerted by each suture on the tissue.

89. The method of claim 88, wherein the pointed ends are needles.

90. The method of claim 88, wherein the needles are straight needles.

91. A method of placing a single-directional barbed suture in bodily tissue, the suture including an elongated
10 body, one pointed end, one end terminating in an anchor, and a plurality of barbs extending from the periphery of the body, the anchor extending outside the periphery of the body to a greater degree than the barbs, the barbs permitting movement of the suture through the tissue in the direction of movement of the pointed end and preventing movement of the suture in a direction opposite the direction of movement of the pointed end, the anchor preventing movement of the suture in the direction of movement of the pointed end, the method comprising:

- 15 (a) making an incision in the tissue to define a face of the tissue;
- (b) inserting the pointed end of the suture in the face of the tissue;
- (c) advancing the pointed end of the suture through the tissue to an exit point;
- (d) placing the anchor in the incision; and
- (e) advancing the pointed end of the suture through the tissue until the anchor achieves adequate
20 holding strength in the tissue to resist further movement in the tissue,

wherein the anchor is embedded in the tissue.

92. The method of claim 91, wherein the pointed end is a needle.

93. The method of claim 91, wherein advancing the suture comprises advancing the suture in a generally
25 curvilinear path and wherein the amplitude of each curvilinear path is generally perpendicular to the resultant holding force exerted by each suture on the tissue.

94. The method of claim 93, wherein the path is sinusoidal.

95. The method of claim 91, wherein the pointed end is a needle.

96. The method of claim 95, wherein the needle is a straight needle.

97. A method for joining two ends of severed internal tissue to allow tissue healing and regrowth together of the
30 two ends of the internal tissue in vivo using a single-directional barbed suture, the suture including an elongated body, one pointed end, one end terminating in an anchor, and a plurality of barbs extending from the periphery of the body, the anchor extending outside the periphery of the body to a greater degree than the barbs, the barbs permitting movement of the suture through the tissue in the direction of movement of the pointed end and preventing movement of the suture in a direction opposite the direction of movement of the pointed end, the anchor preventing movement of
35 the suture in the direction of movement of the pointed end, the method comprising:

- (a) inserting the pointed end of the suture into a first end of the internal tissue;
pushing the pointed end through the internal tissue along a curvilinear path, proceeding away from the first
end and farther into the tissue;
- (b) gripping the pointed end of the suture and pulling the pointed end out of the internal tissue for
40 drawing the anchor proximate to the first end of the tissue;

(c) pushing the pointed end along the curvilinear path then returning along the path to the first end, and exiting from the first end of the tissue;

(d) inserting the pointed end into an opposing, second end of tissue;

5 (e) pushing the pointed end along a curvilinear path, proceeding away from the second end and farther into the tissue, then returning to the second end, and exiting from the second end of the tissue; and

(f) inserting the pointed end into the first end of tissue, pushing the pointed end along a curvilinear path, proceeding away from the second end and farther into the tissue, then returning toward the first end and exiting the tissue.

98. The method of claim 97, wherein the pointed end is a needle.

10

99. A method of placing a single-directional barbed suture in a bodily tube to approximate first and second ends of the tube, the suture including an elongated body, one pointed end, one end terminating in an anchor, and a plurality of barbs extending from the periphery of the body, the anchor extending outside the periphery of the body to a greater degree than the barbs, the barbs permitting movement of the suture through the tissue in the direction of movement of
15 the pointed end and preventing movement of the suture in a direction opposite the direction of movement of the pointed end, the anchor preventing movement of the suture in the direction of movement of the pointed end, the method comprising:

(a) inserting the pointed end of the suture through the wall and into the interior of the first end of the tube;

20 (b) inserting the pointed end of the suture from the interior of the tube through the wall of the second end of the tube;

(c) advancing the suture through the walls of the tube until the anchor contacts the outer surface of the wall of the first end of the tube for drawing together the two ends of the tube;

25 (d) inserting the pointed end of the suture through the wall of the first end of the tube at a point circumferentially spaced from the previous insertion point; and

(e) repeating steps (b) through (d) for advancing the suture around the tube.

100. The method of claim 99, wherein the one pointed end of the barbed suture is a needle.

30 101. The method of claim 99, wherein the suture pattern terminates in a path selected from the group including a J-stitch and an inverted J-stitch.

102. The method of claim 99, wherein the suture pattern terminates in a path selected from the group including an S-stitch and an inverted S-stitch.

35

103. A method of placing a bi-directional barbed suture in a bodily tube to approximate first and second ends of the tube, the barbed suture including an elongated body, first and second sharp pointed distal ends for penetrating tissue, and a plurality of barbs extending from the periphery of the body, the barbs on a first portion of the body between the first end of the suture and a first axial location on the body for permitting movement of the suture through the tissue
40 in a direction of movement of the first end and preventing movement of the suture relative to the tissue in a direction

opposite the direction of movement of the first end, and the barbs on a second portion of the body between the second end of the suture and a second axial location on the body which is less than the distance from the second end to the first axial location permitting movement of the suture through the tissue in a direction of movement of the second end and preventing movement of the suture relative to the tissue in a direction opposite the direction of movement of the second end, the method comprising:

- (a) inserting an end of the first portion of the suture through the wall and into the interior of the first end of the tube;
- (b) inserting the end of the first portion of the suture from the interior of the tube through the wall of the second end of the tube;
- (c) advancing the first portion of the suture through the walls of the tube until the opposed barbs on the second portion of the suture contact the outer surface of the wall of the first end of the tube for drawing the two ends of the tube together;
- (d) inserting the end of the first portion of the suture through the wall and into the interior of the first end of the tube at a point circumferentially spaced in a first direction from the previous insertion point of the first end of the suture;
- (e) inserting the end of the second portion of the suture through the wall and into the interior of the second end of the tube at a point circumferentially spaced from the exit point of the end of the first portion of the suture;
- (f) inserting the end of the second portion of the suture from the interior of the tube through the wall of the first end of the tube at a point circumferentially spaced in a second direction from the initial insertion point of the second end of the suture; and
- (g) repeating steps (a) through (f) for advancing each end of the barbed suture around the tube.

104. The method of claim 103, wherein the first and second sharp pointed distal ends of the suture are needles.

105. The method of claim 103, wherein the suture pattern at the ends of the suture terminates in a path selected from the group including a J-stitch and an inverted J-stitch.

106. The method of claim 103, wherein the suture pattern at the ends of the suture terminates in a path selected from the group including an S-stitch and an inverted S-stitch.

107. A method of placing a bi-directional barbed suture in a bodily tube to approximate first and second ends of the tube, the barbed suture including an elongated body, first and second sharp pointed distal ends for penetrating tissue, and a plurality of barbs extending from the periphery of the body, the barbs on a first portion of the body between the first end of the suture and a first axial location on the body for permitting movement of the suture through the tissue in a direction of movement of the first end and preventing movement of the suture relative to the tissue in a direction opposite the direction of movement of the first end, and the barbs on a second portion of the body between the second end of the suture and a second axial location on the body which is less than the distance from the second end to the first axial location permitting movement of the suture through the tissue in a direction of movement of the second end

and preventing movement of the suture relative to the tissue in a direction opposite the direction of movement of the second end, the method comprising:

- (a) inserting an end of the first portion of the suture through the wall of the first end of the tube;
- 5 (b) inserting the end of the first portion of the suture from the interior of the tube through the wall of the second end of the tube;
- (c) advancing the first portion of the suture through the walls of the tube until the opposed barbs on the second portion of the suture contact the outer surface of the wall of the first end of the tube for drawing the two ends of the tube together;
- 10 (d) inserting the end of the first portion of the suture through the wall and into the interior of the first end of the tube at a point circumferentially spaced in a first direction from the previous insertion point of the first portion of the suture;
- (e) inserting the second portion of the suture through the wall of the first end of the tube at a point adjacent the initial insertion point of the first portion of the suture;
- 15 (f) inserting the end of the second portion of the suture from the interior of the tube through the wall of the second end of the tube at a point circumferentially spaced from the adjacent exit point of the end of the first portion of the suture;
- (g) inserting the end of the second portion of the suture through the wall of the first end of the tube at a point circumferentially spaced in a second direction from the previous insertion point of the second portion of the suture; and
- 20 (h) repeating steps (b) through (g) for advancing each end of the barbed suture around the tube.

108. The method of claim 107, wherein the first and second sharp pointed distal ends of the suture are needles.

25 109. The method of claim 107, wherein the suture pattern at the ends of the suture terminates in a path selected from the group including a J-stitch and an inverted J-stitch.

110. The method of claim 107, wherein the suture pattern at the ends of the suture terminates in a path selected from the group including an S-stitch and an inverted S-stitch.

30

111. The method of claim 107, wherein the suture pattern at the ends of the suture terminates in crossed ends of the suture.

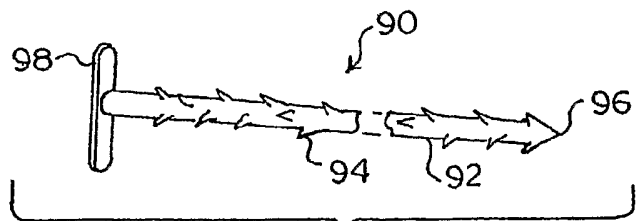

FIG. 1



FIG. 2

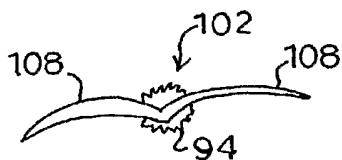

FIG. 3

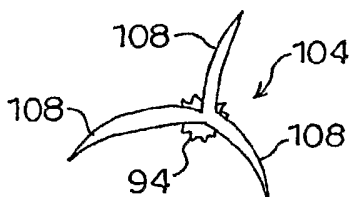

FIG. 4

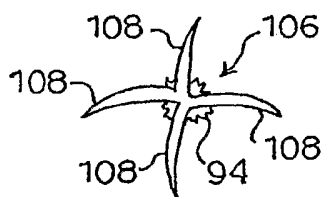

FIG. 5

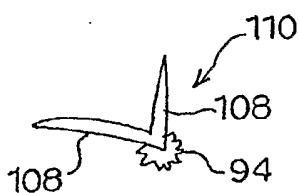

FIG. 6

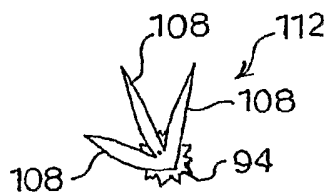

FIG. 7

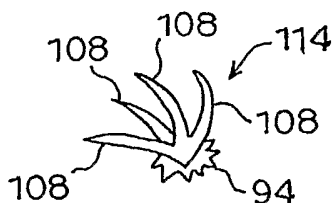

FIG. 8

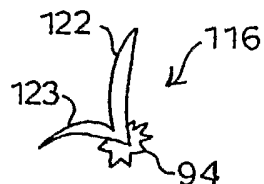

FIG. 9

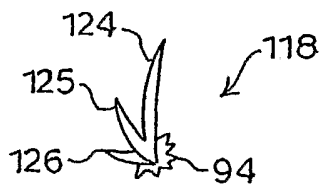

FIG. 10

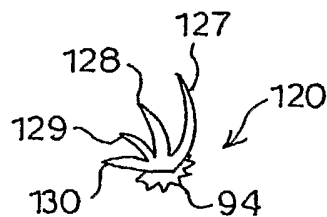

FIG. 11

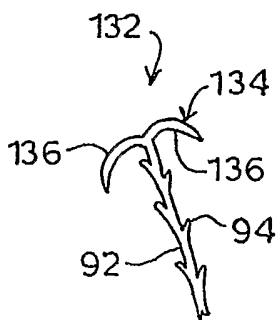

FIG. 12

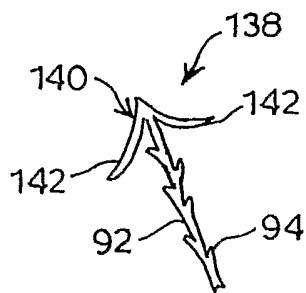

FIG. 13

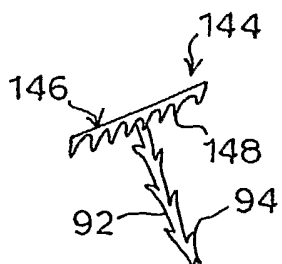

FIG. 14

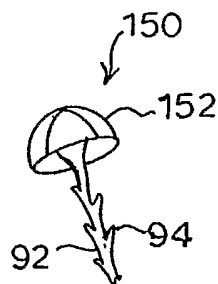

FIG. 15

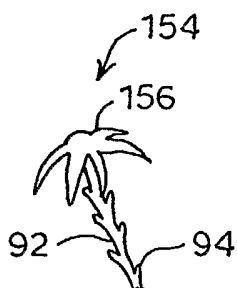

FIG. 16

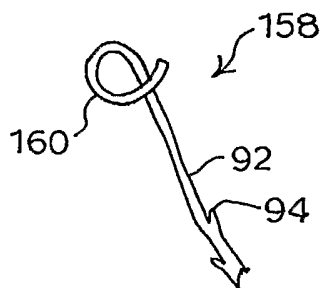

FIG. 17

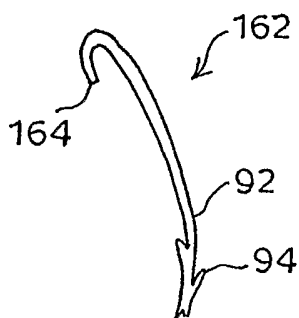

FIG. 18

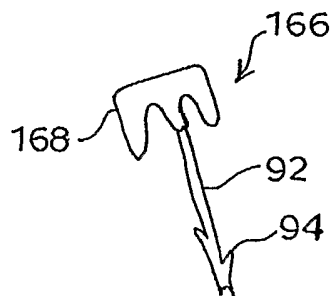

FIG. 19

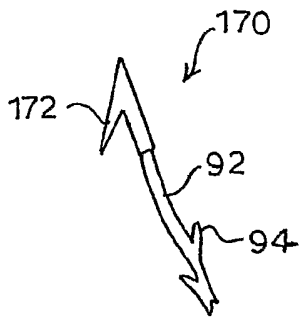
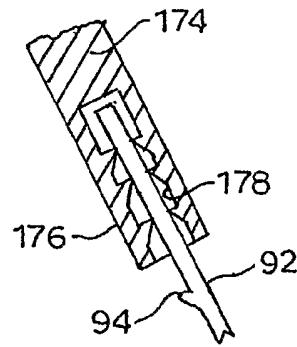

FIG. 20



PRIOR ART

FIG. 21

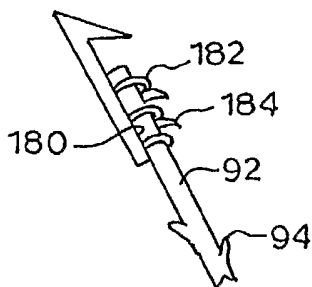

FIG. 22

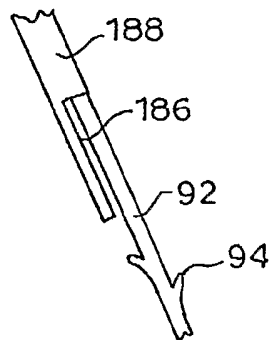

FIG. 23

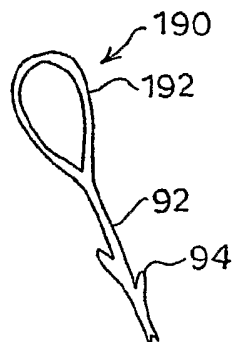

FIG. 24

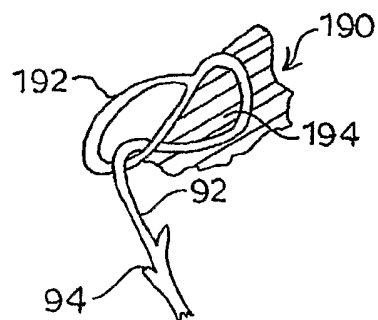

FIG. 25

5/19

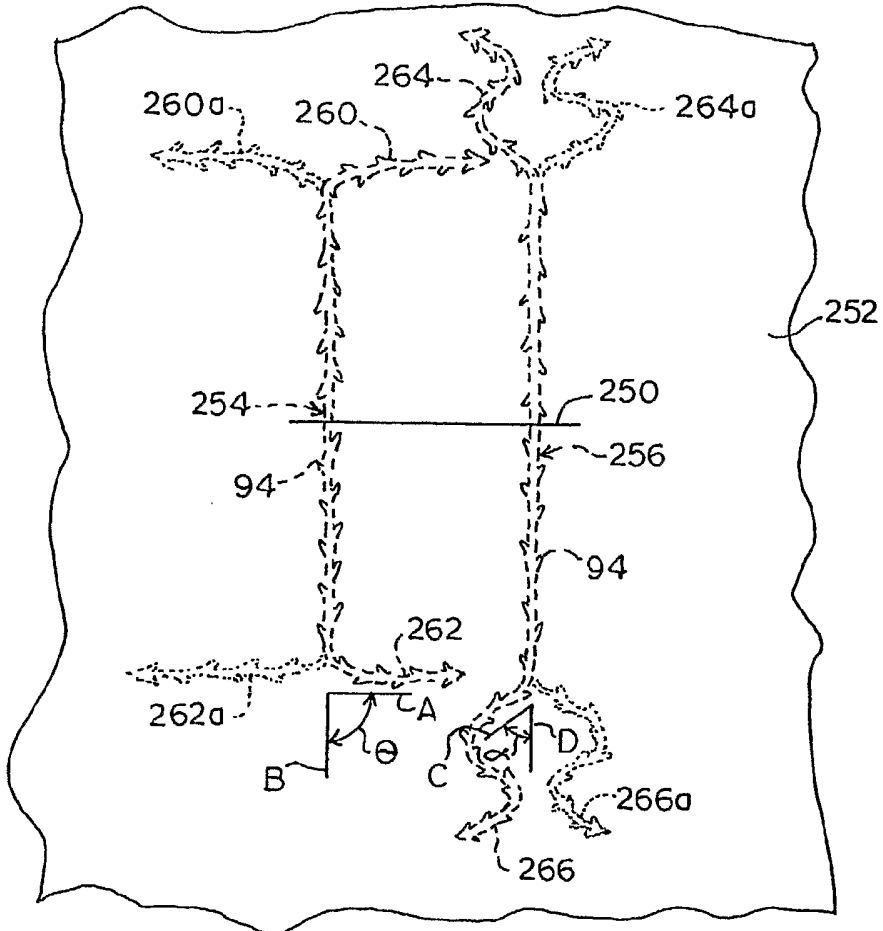

FIG. 26

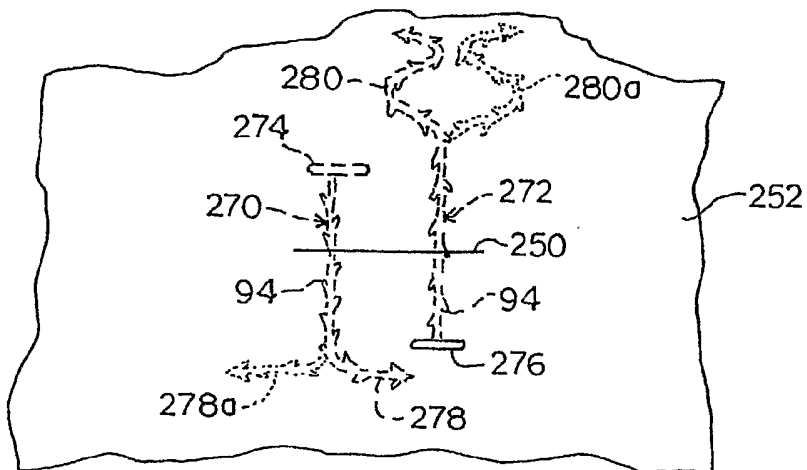

FIG. 27

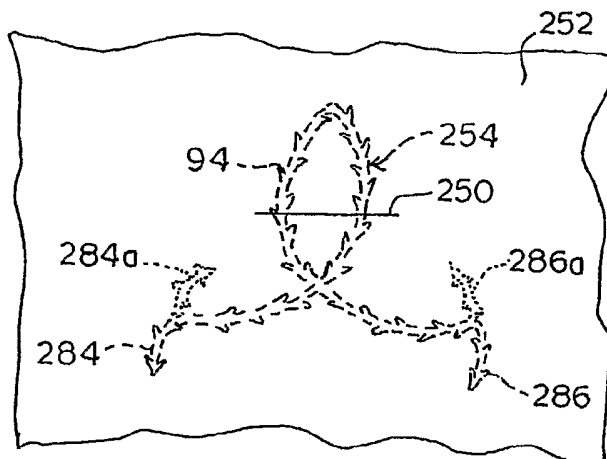

FIG. 28

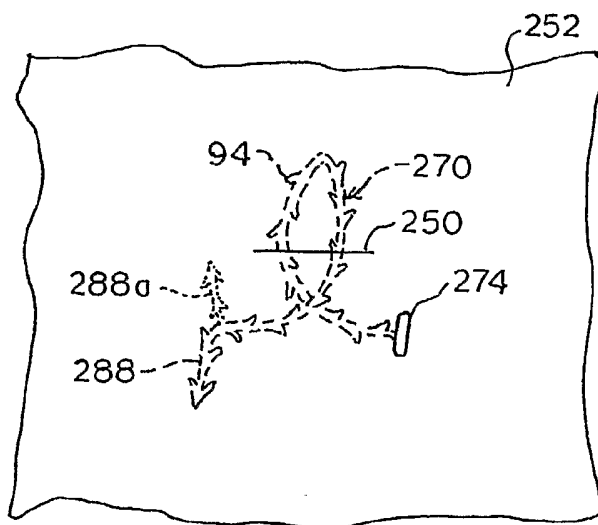

FIG. 29

7/19

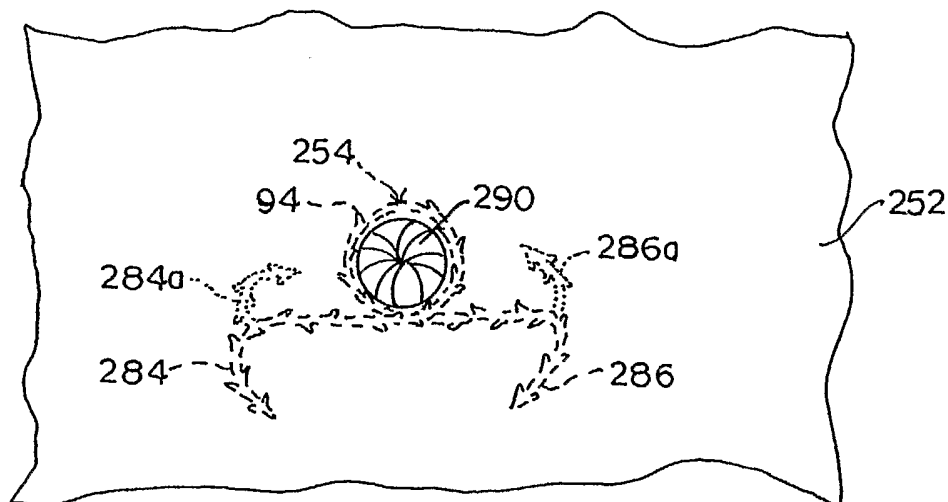

FIG. 30

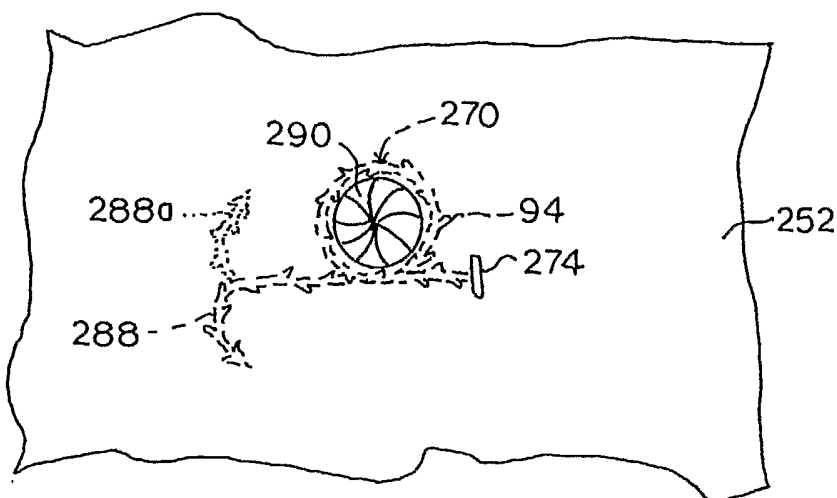

FIG. 31

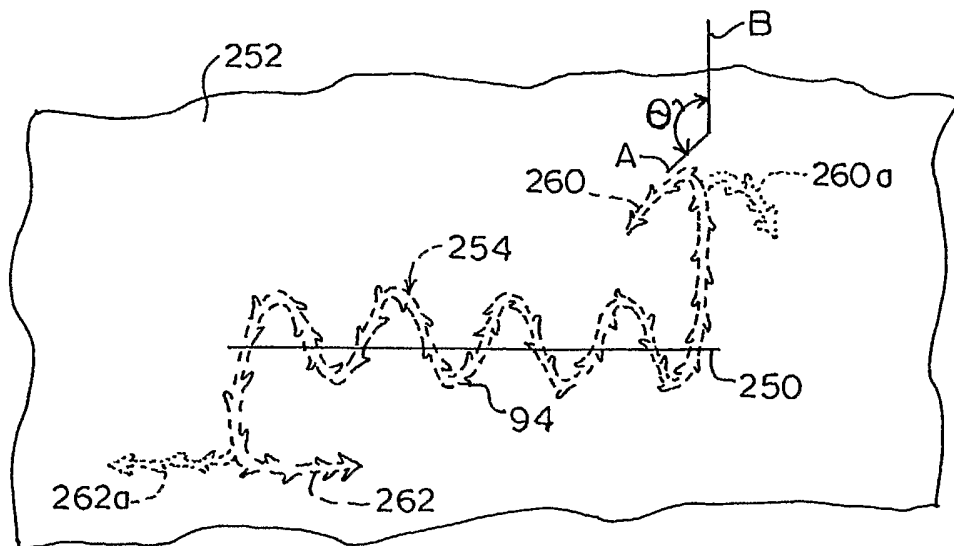

FIG. 32

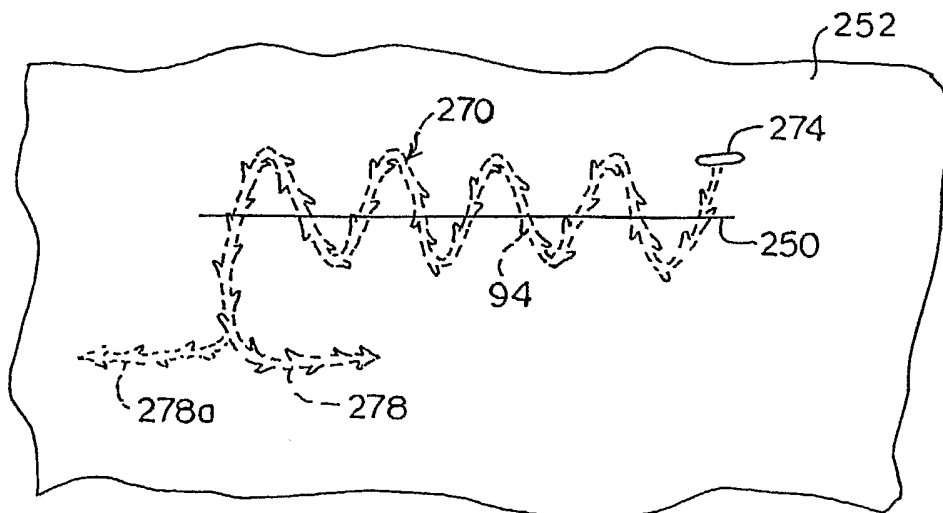

FIG. 33

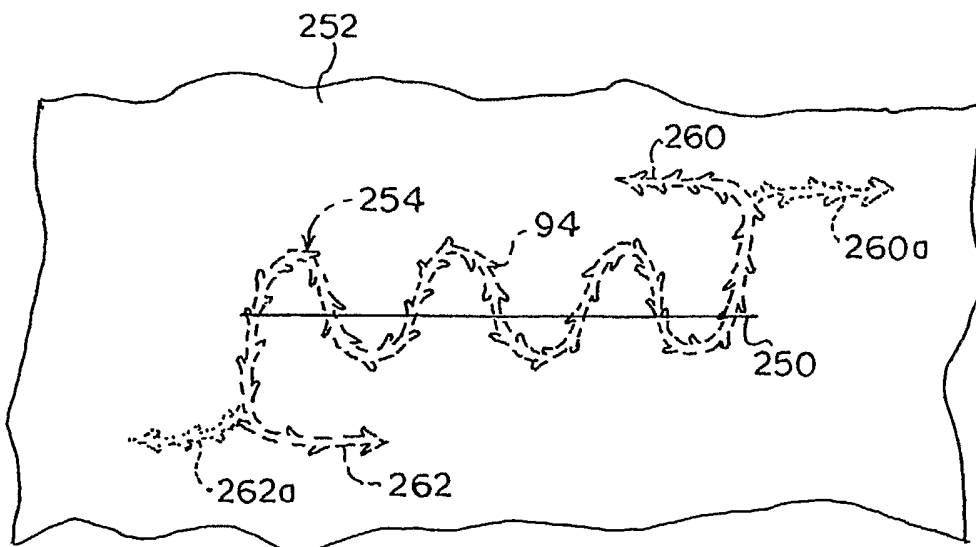

FIG. 34

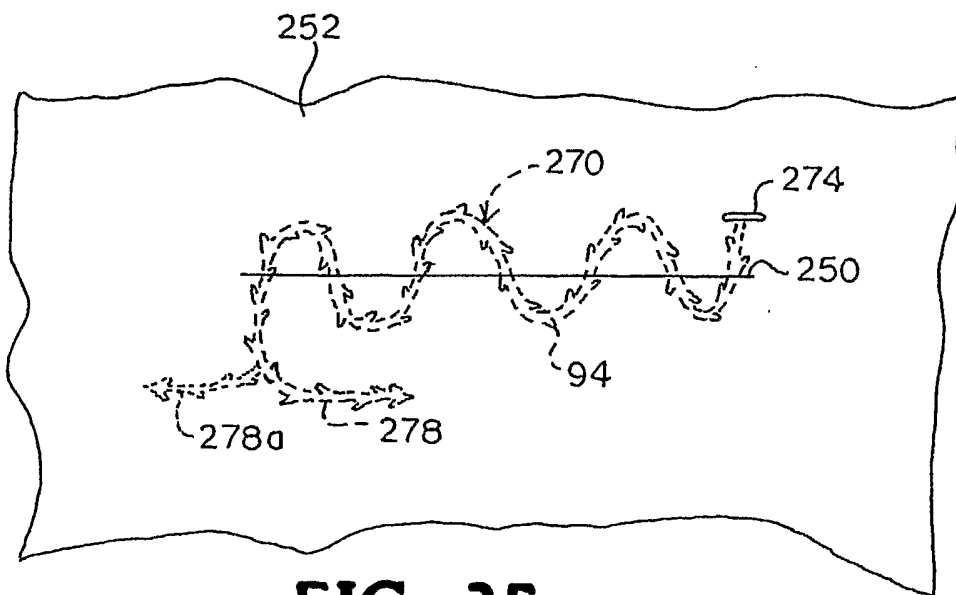

FIG. 35

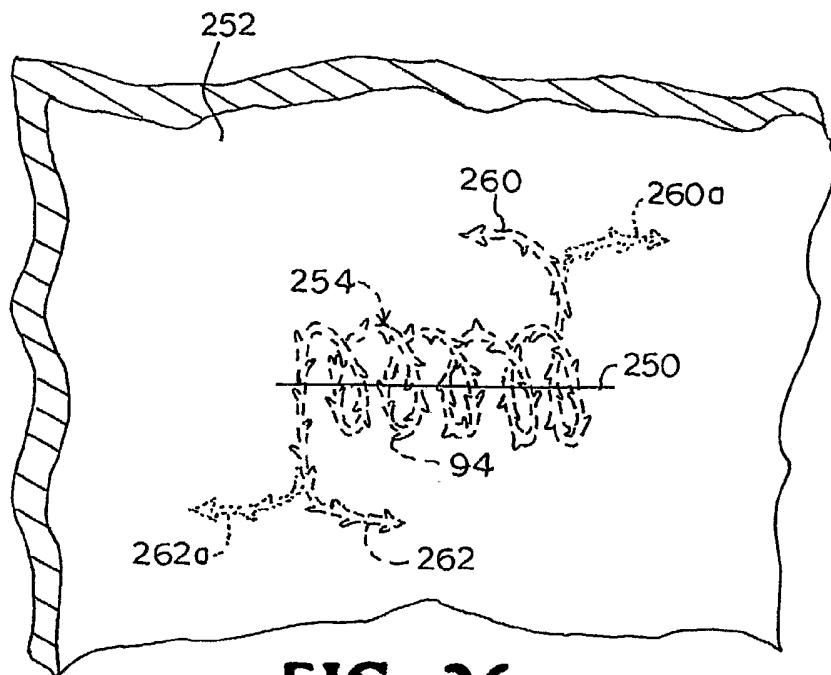

FIG. 36

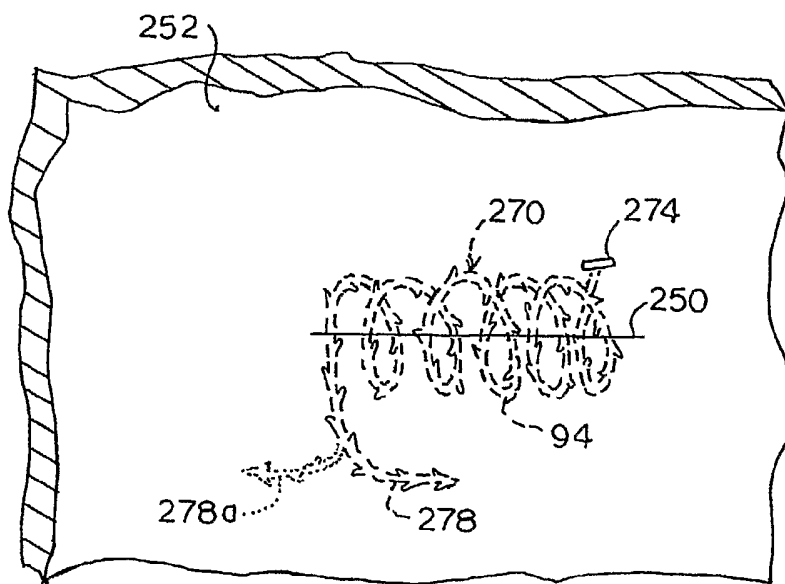

FIG. 37

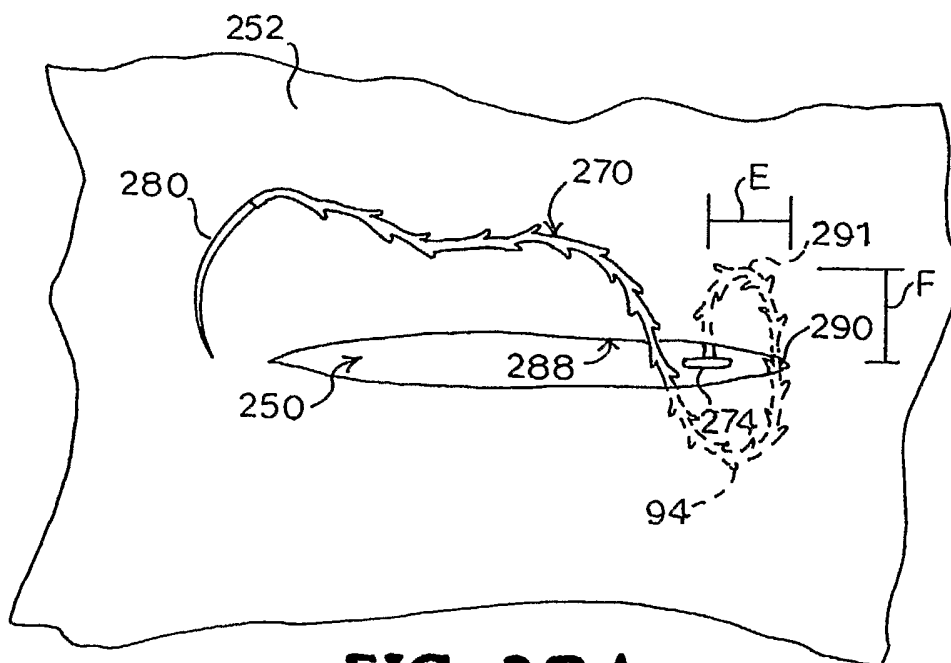

FIG. 38A

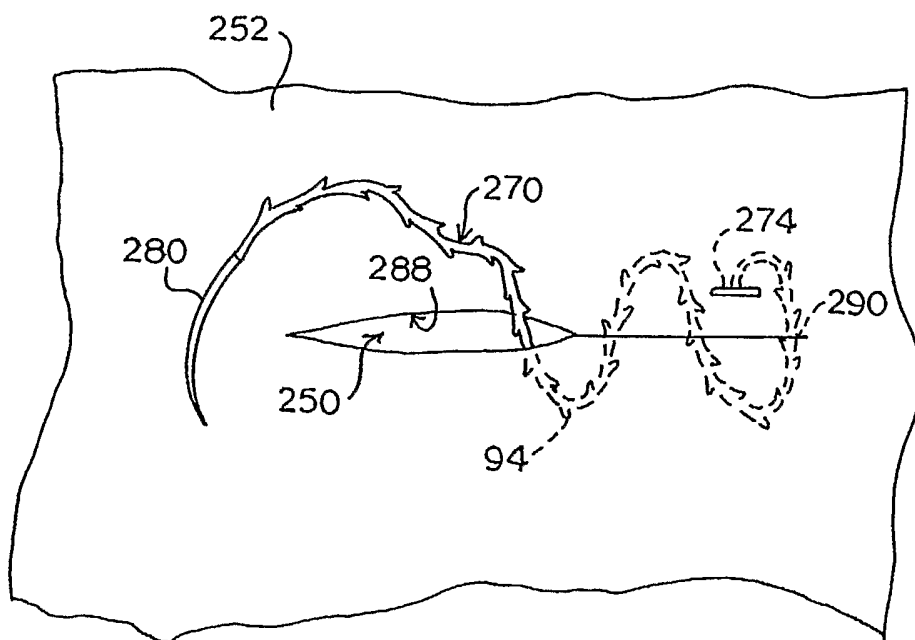

FIG. 38B

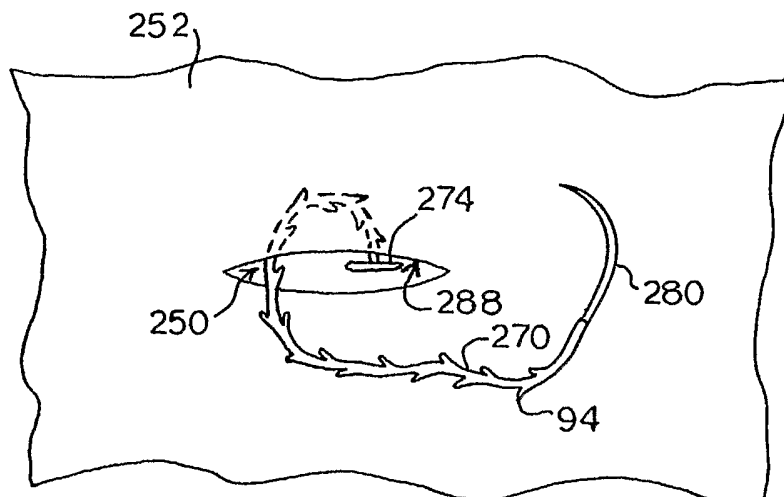

FIG. 39A

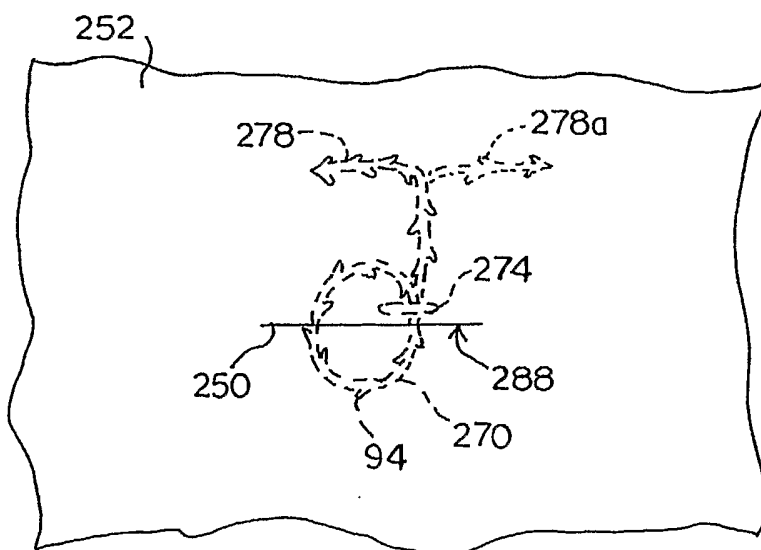
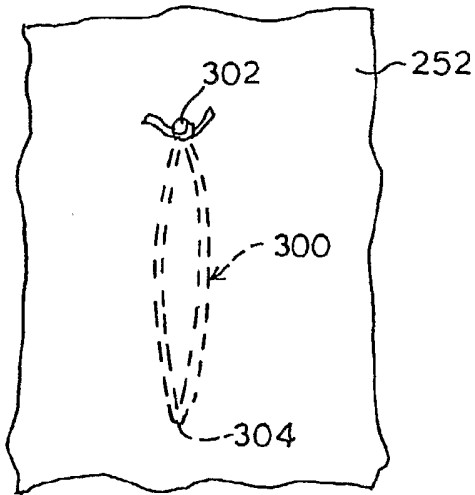
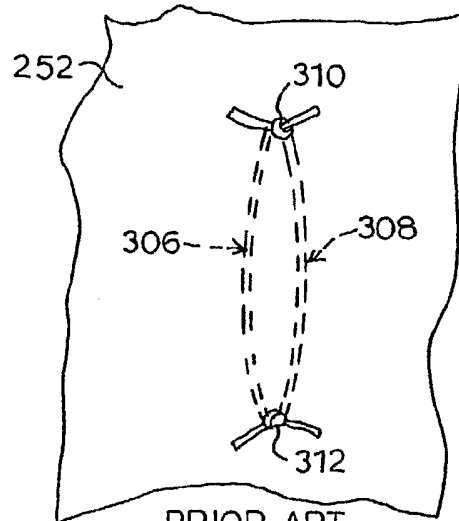

FIG. 39B



PRIOR ART
FIG. 40



PRIOR ART
FIG. 41

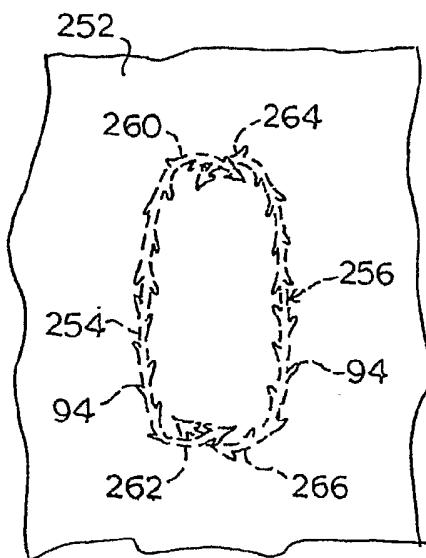

FIG. 42

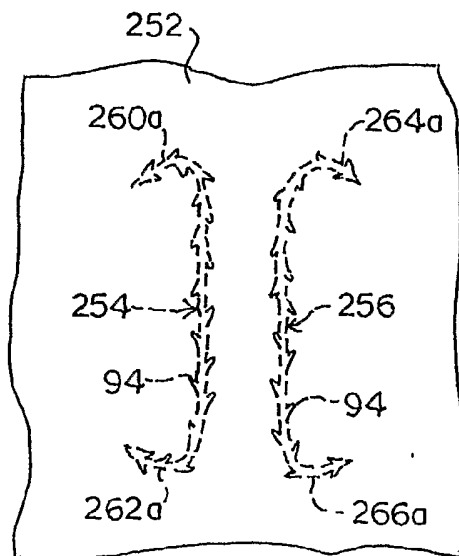

FIG. 43

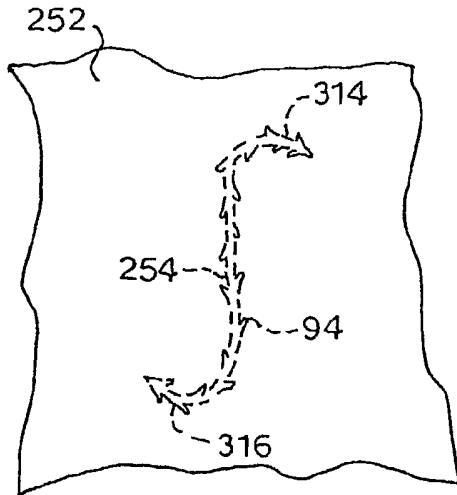

FIG. 44

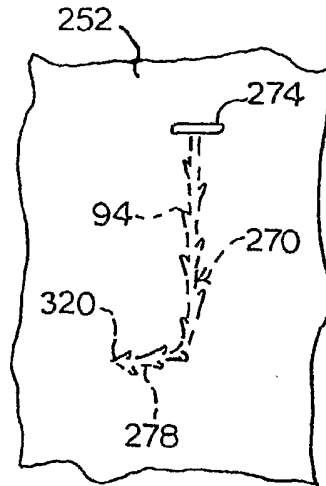

FIG. 45

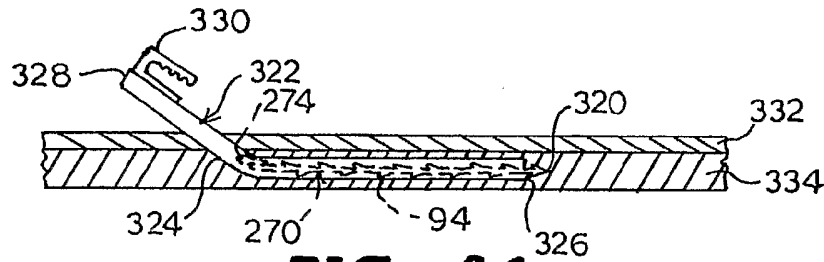

FIG. 46

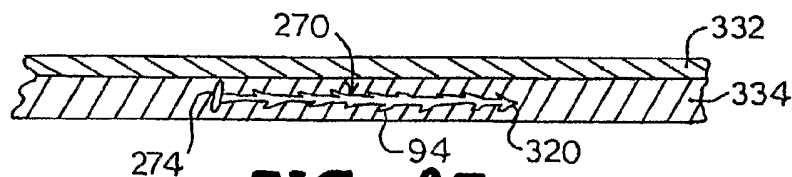

FIG. 47

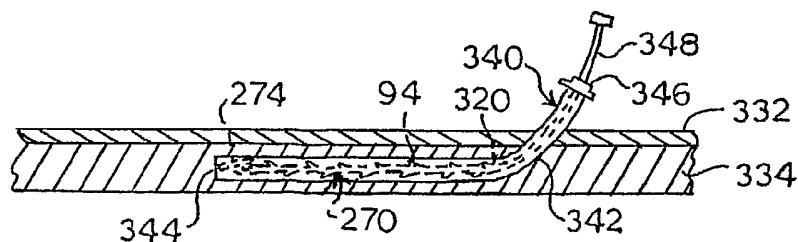

FIG. 48

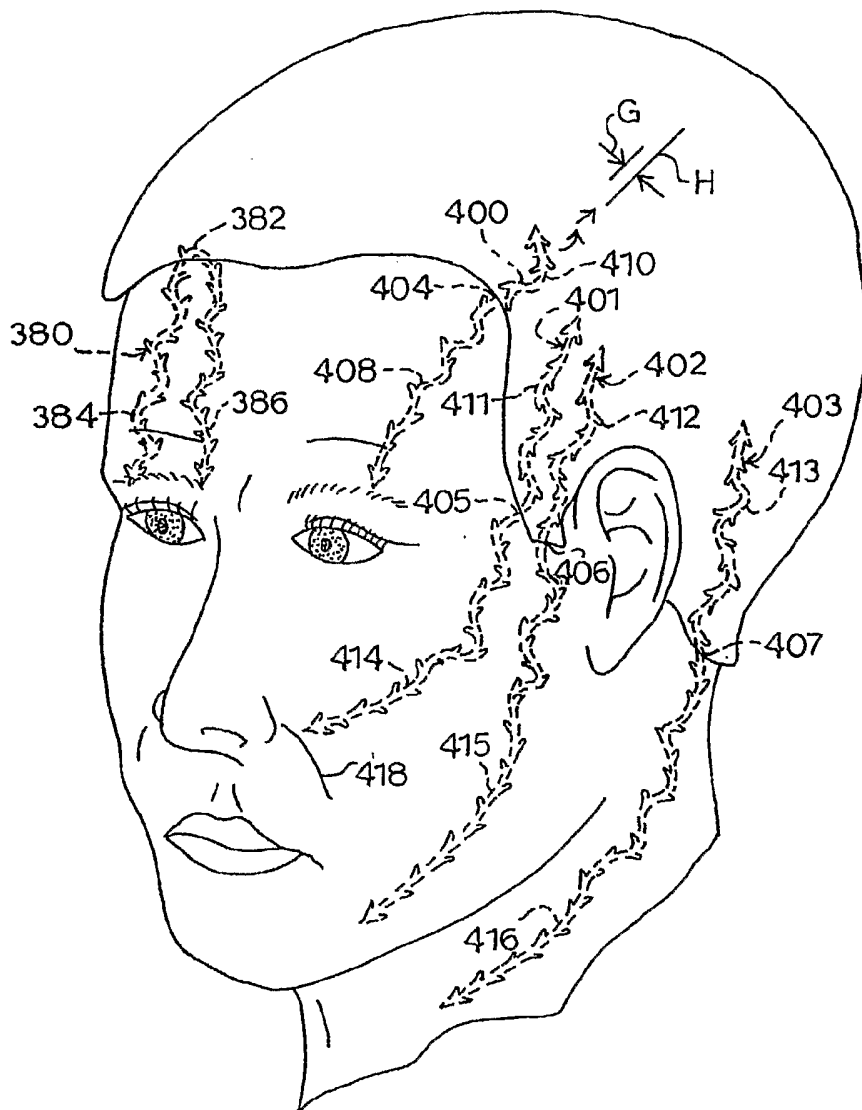

FIG. 49

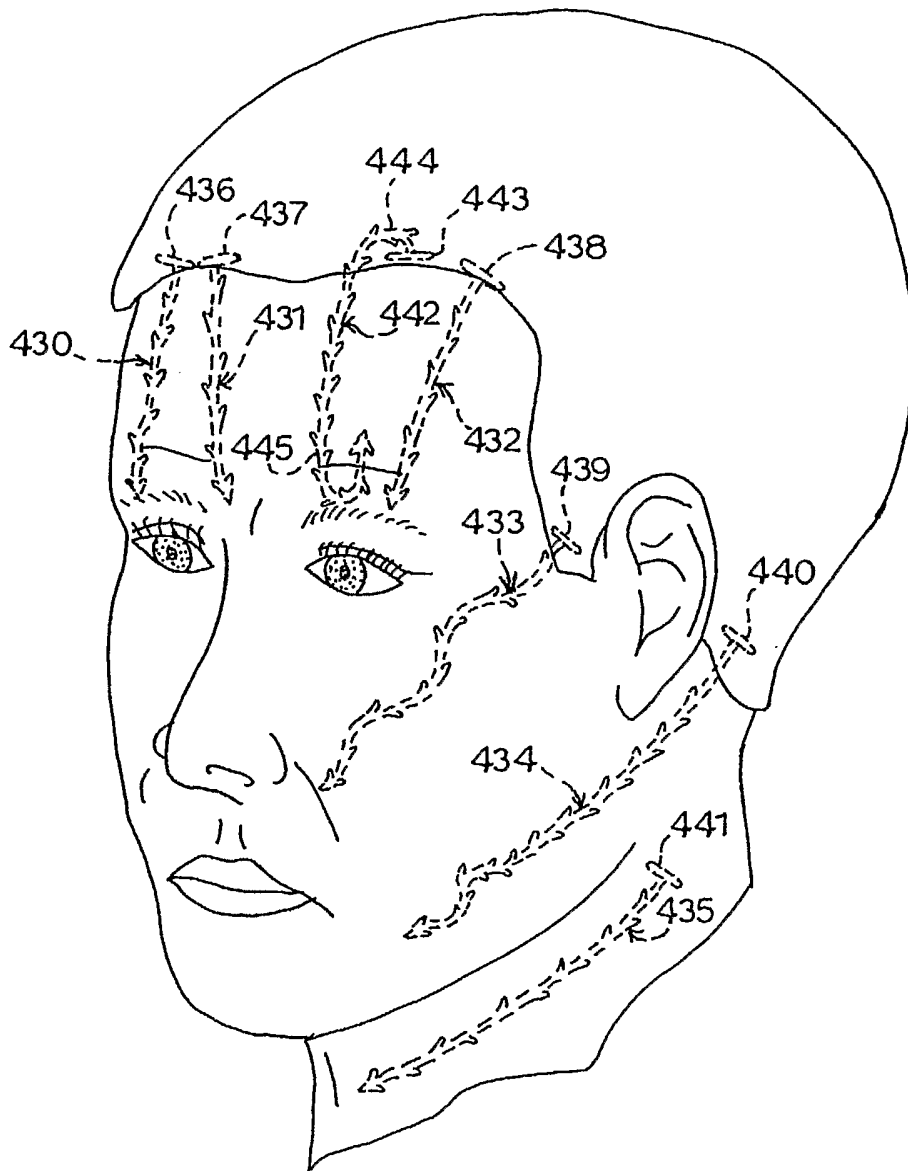

FIG. 50

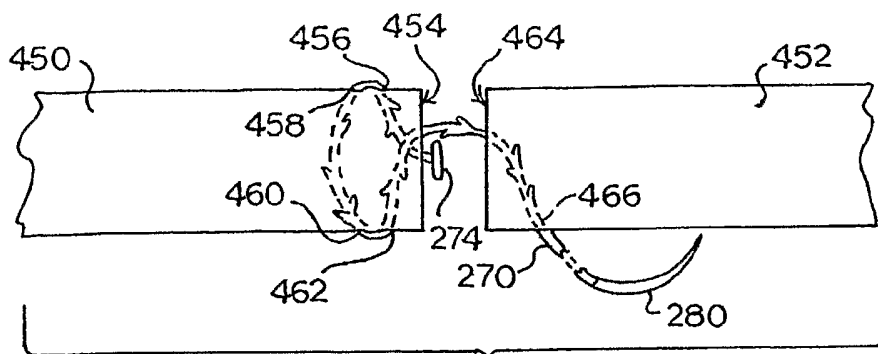

FIG. 51A

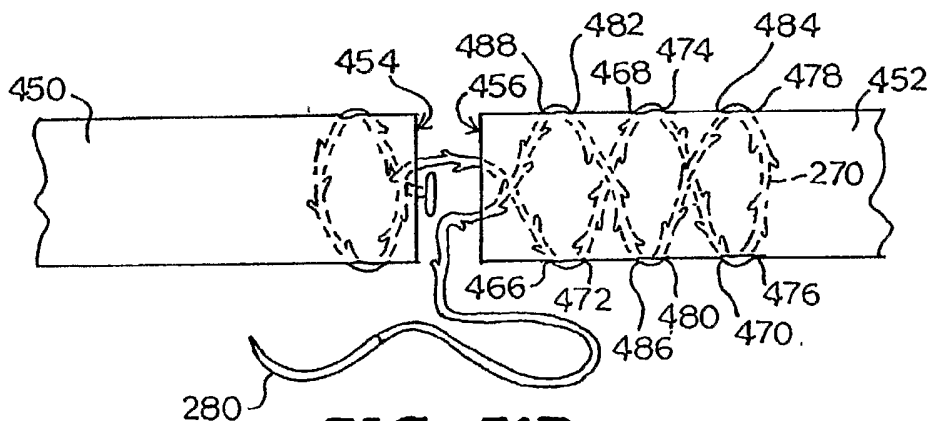

FIG. 51B

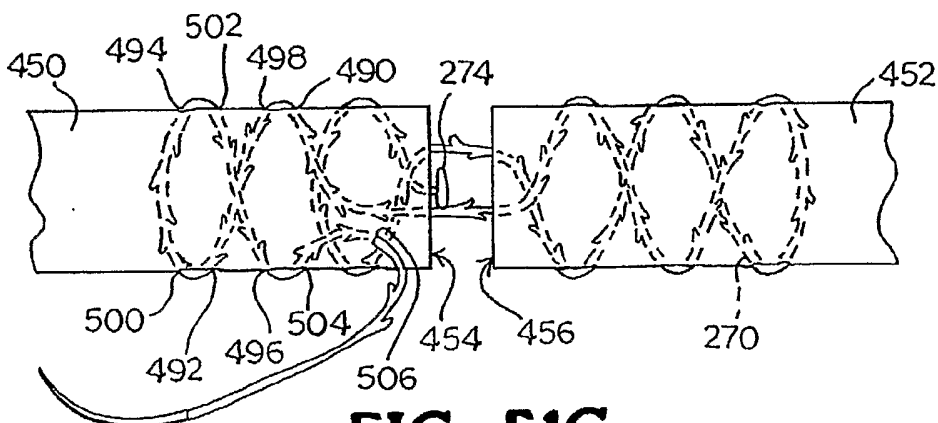

FIG. 51C

18/19

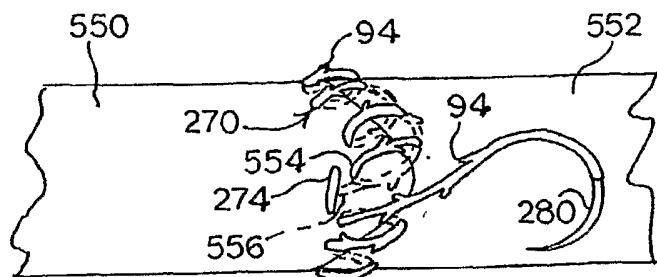

FIG. 52

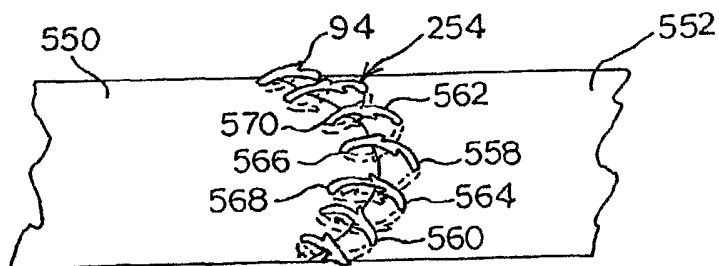

FIG. 53

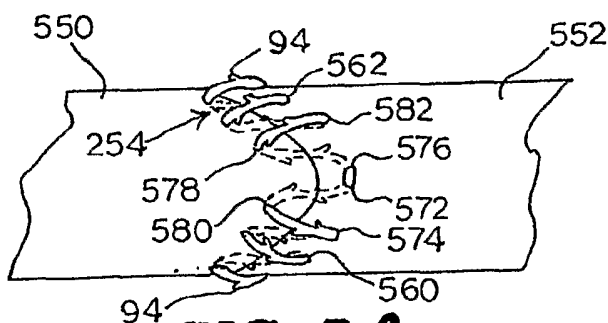

FIG. 54

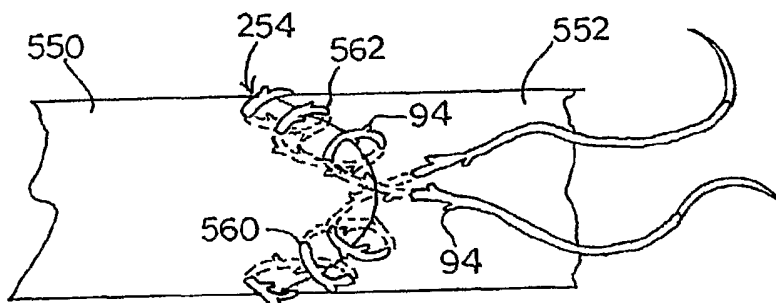

FIG. 55

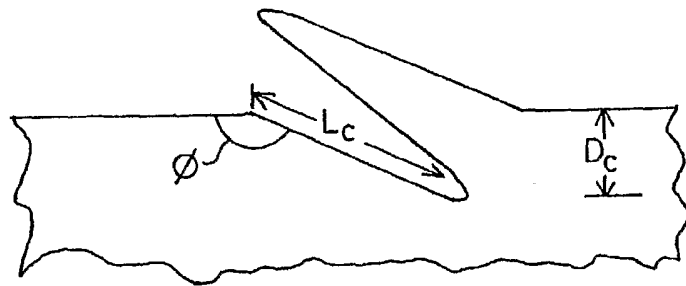

FIG. 56

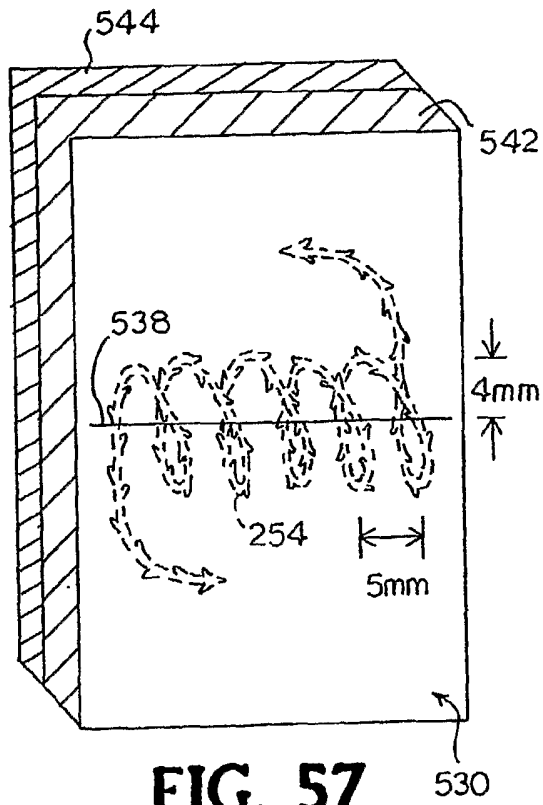
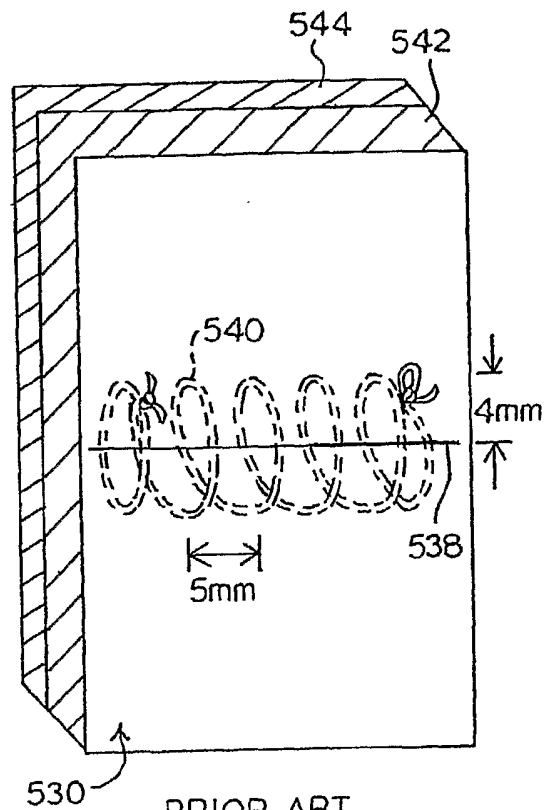

FIG. 57



PRIOR ART
FIG. 58