



US00D785632S

(12) **United States Design Patent**
VanDuyn et al.

(10) **Patent No.:** **US D785,632 S**

(45) **Date of Patent:** **** May 2, 2017**

- (54) **HUB**
- (71) Applicant: **EchoStar Technologies L.L.C.**,
Englewood, CO (US)
- (72) Inventors: **Luke VanDuyn**, Conifer, CO (US);
Neil T. Marten, Lakewood, CO (US)
- (73) Assignee: **Echostar Technologies L.L.C.**,
Englewood, CO (US)
- (**) Term: **15 Years**
- (21) Appl. No.: **29/550,327**

- D711,884 S * 8/2014 Turksu D14/433
- D716,309 S * 10/2014 Krenkler D14/433
- D720,755 S * 1/2015 Nokuo D14/433
- D729,807 S * 5/2015 Hsu D14/433
- D742,884 S * 11/2015 Seflic D14/433
- D759,016 S * 6/2016 Zaslavsky D14/433
- D769,246 S * 10/2016 Mielnik D14/433

* cited by examiner

Primary Examiner — Austin Murphy

(74) *Attorney, Agent, or Firm* — Kilpatrick Townsend & Stockton LLP

- (22) Filed: **Dec. 31, 2015**
- (51) **LOC (10) Cl.** **14-02**
- (52) **U.S. Cl.** **D14/433**
- (58) **Field of Classification Search**
USPC D14/356, 432-434, 453, 454, 511, 203.8,
D14/209.1, 238.1, 240, 125; 439/638,
439/928, 105, 502; 710/303, 304;
361/679.41, 679.55, 679.56; D13/110,
D13/133, 146, 123, 162
CPC ... H04L 12/2832; H04L 12/2838; G06F 3/00;
G06F 5/00; G06F 13/14
See application file for complete search history.

(57) **CLAIM**

I claim the ornamental design for a hub, substantially as shown and described.

DESCRIPTION

FIG. 1 is a first perspective view of a hub;
 FIG. 2 is a second perspective view thereof;
 FIG. 3 is a front view thereof;
 FIG. 4 is a rear view thereof;
 FIG. 5 is a top view thereof;
 FIG. 6 is a bottom view thereof;
 FIG. 7 is a right side view thereof; and,
 FIG. 8 is a left side view thereof.
 The broken lines in the figures are for illustrative purposes only, and form no part of the claimed design.

1 Claim, 8 Drawing Sheets

- (56) **References Cited**
U.S. PATENT DOCUMENTS
D670,291 S * 11/2012 Dalton B25C 7/00
D14/433
D705,189 S * 5/2014 Chovin D14/159

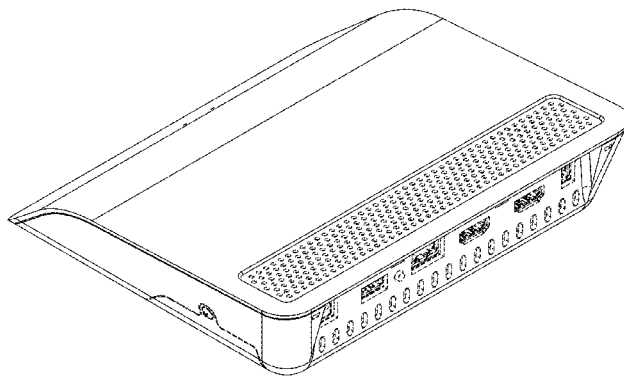
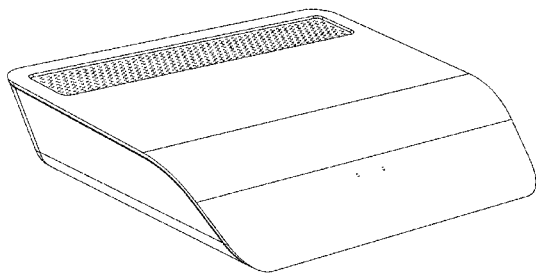

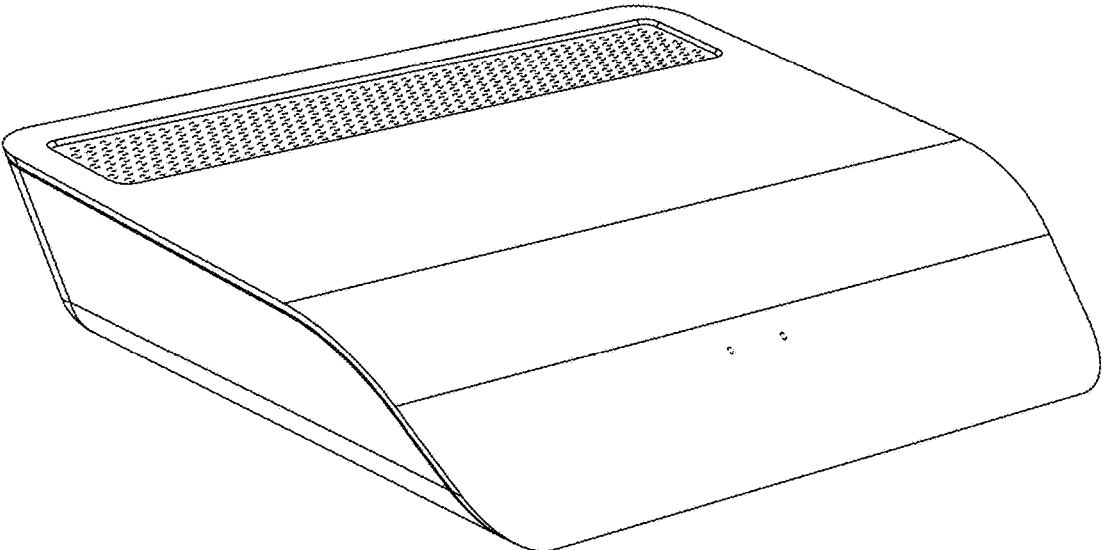

Fig. 1

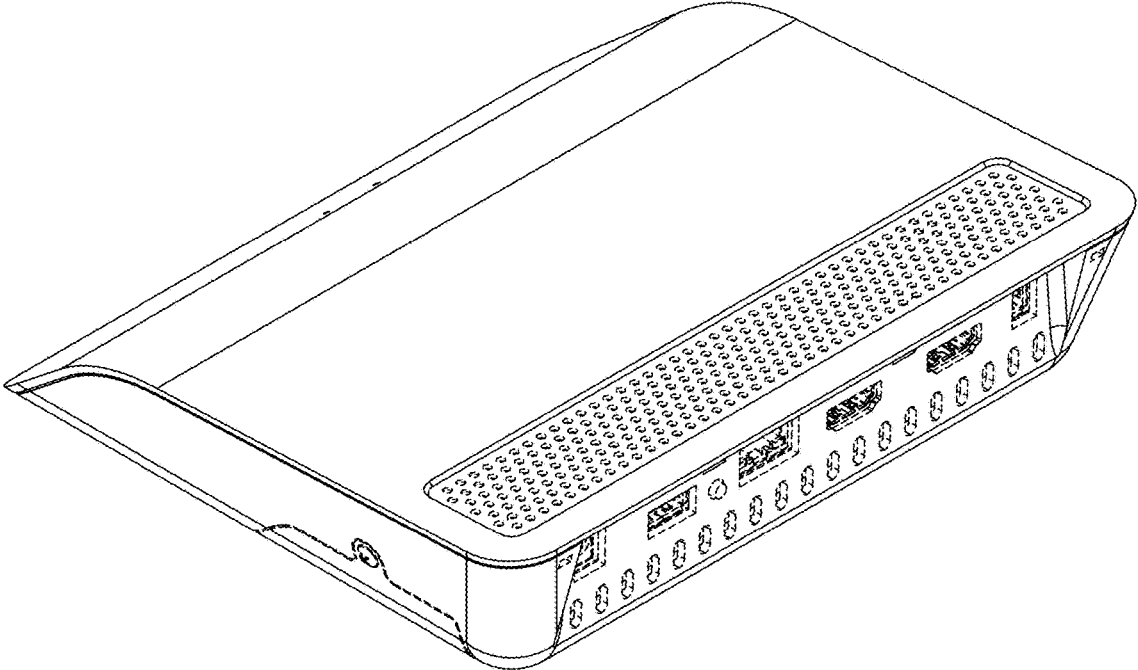

Fig. 2

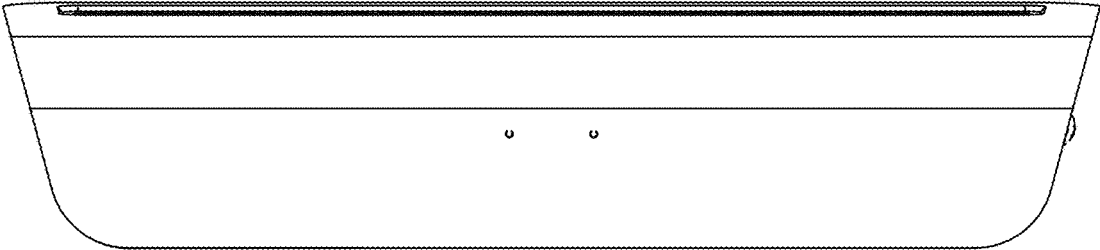

Fig. 3

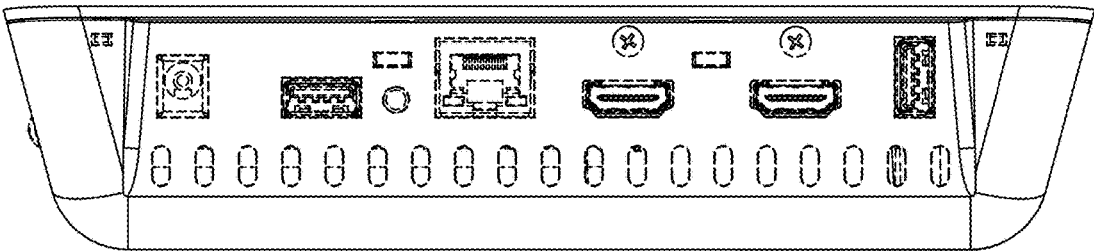

Fig. 4

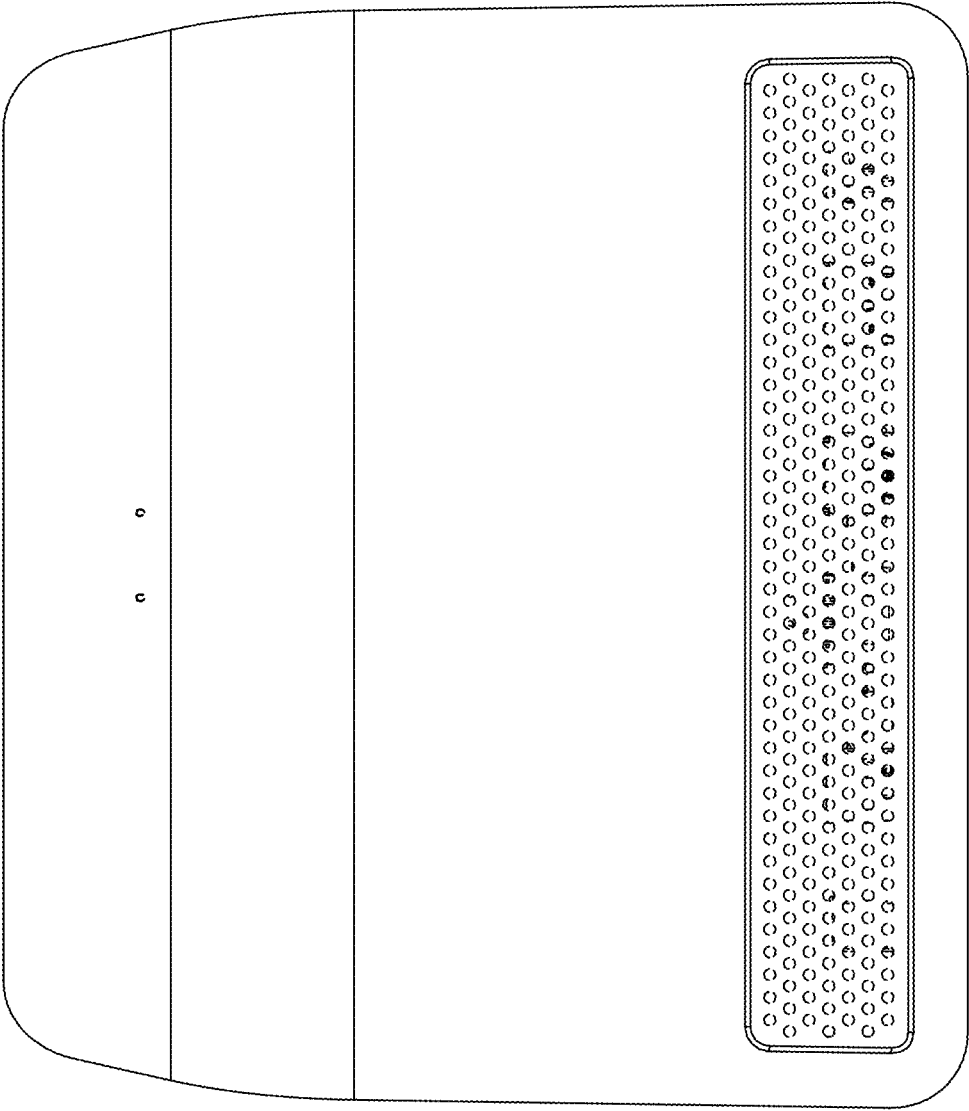

Fig. 5

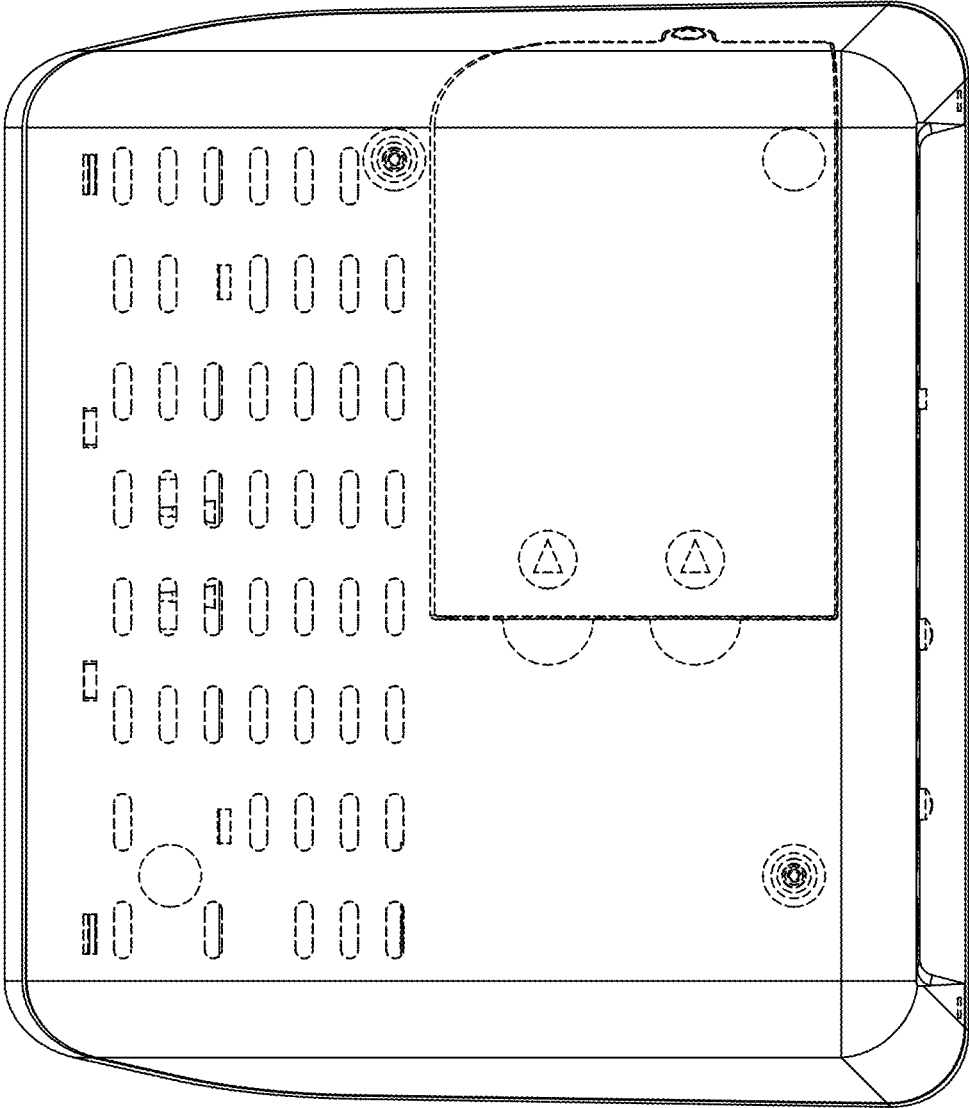

Fig. 6

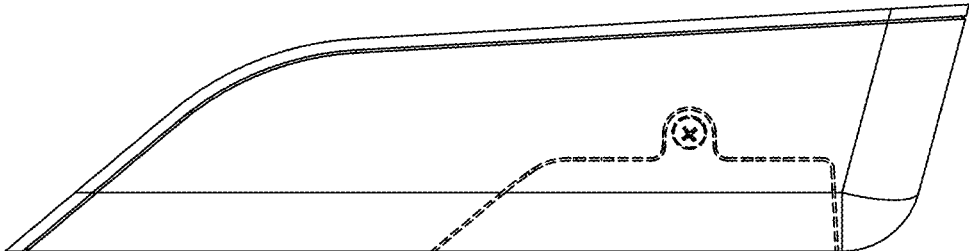

Fig. 7

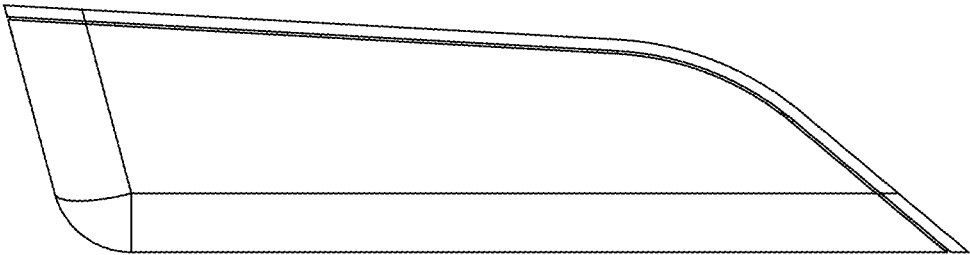

Fig. 8