



US0D1004147S

(12) **United States Design Patent**
Wu

(10) **Patent No.:** **US D1,004,147 S**

(45) **Date of Patent:** **** Nov. 7, 2023**

(54) **VEHICLE LAMP**

(71) Applicant: **COPLUS INC.**, Tainan (TW)

(72) Inventor: **Po-Hua Wu**, Tainan (TW)

(73) Assignee: **COPLUS INC.**, Tainan (TW)

(**) Term: **15 Years**

(21) Appl. No.: **29/784,470**

(22) Filed: **May 19, 2021**

Related U.S. Application Data

(63) Continuation-in-part of application No. 29/747,243, filed on Aug. 20, 2020.

Foreign Application Priority Data

Jan. 15, 2021 (TW) 109303104D01

(51) **LOC (14) Cl.** **26-06**

(52) **U.S. Cl.**
USPC **D26/28**

(58) **Field of Classification Search**

USPC D26/28, 29, 30, 31, 32, 33, 34, 35, 36,
D26/37, 2, 39, 122, 123, 24, 25, 26, 113,
D26/120; D12/181, 183, 196, 107, 400,
D12/86
CPC F21S 48/225; F21S 48/10; F21S 48/1266;
F21S 48/1388; F21S 43/237; F21S 43/15;
F21S 43/00; F21S 41/36; F21S 41/50;
F21S 41/26; F21S 41/00; F21V 21/04

See application file for complete search history.

(56) **References Cited**

U.S. PATENT DOCUMENTS

D815,324	S	*	4/2018	Anderson	D26/28
D841,843	S	*	2/2019	Park	D26/28
D841,844	S	*	2/2019	Perkins	D26/28
D843,029	S	*	3/2019	Lee	D26/28
D852,394	S	*	6/2019	Lai	D26/28
D858,821	S	*	9/2019	Park	D26/28
D893,067	S	*	8/2020	Lin	D26/28
D920,546	S	*	5/2021	Lin	D26/28

* cited by examiner

Primary Examiner — Joshua Kading

Assistant Examiner — Kathryn Elizabeth Chambers

(74) *Attorney, Agent, or Firm* — Lewis Roca Rothgerber Christie LLP

(57) **CLAIM**

The ornamental design for a vehicle lamp, as shown and described.

DESCRIPTION

FIG. 1 is a top, front, left perspective view of a vehicle lamp showing my new design;
FIG. 2 is another top, front, left perspective view thereof;
FIG. 3 is a front elevational view thereof;
FIG. 4 is a rear elevational view thereof;
FIG. 5 is a left side elevational view thereof;
FIG. 6 is a right side elevational view thereof;
FIG. 7 is a top plan view thereof; and,
FIG. 8 is a bottom plan view thereof.
The broken lines depict portions of the vehicle lamp in which the design is embodied that form no part of the claimed design.

1 Claim, 8 Drawing Sheets

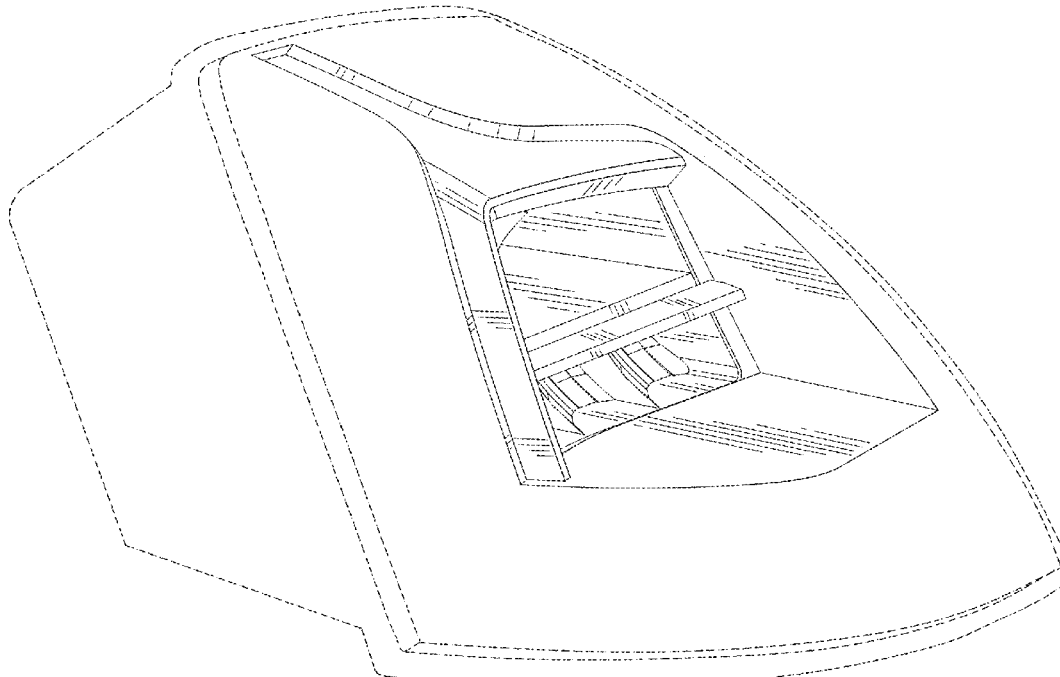

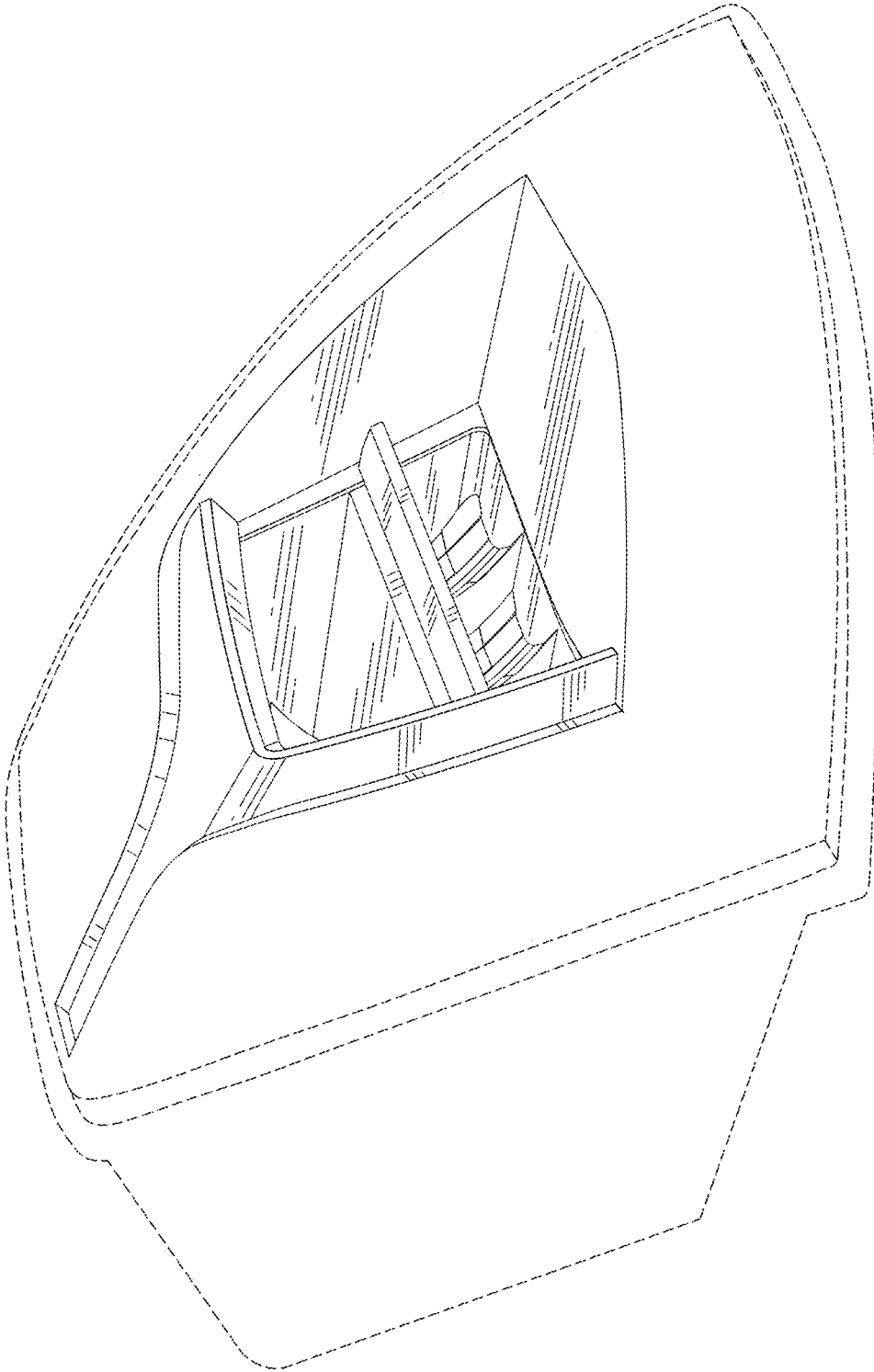

FIG. 1

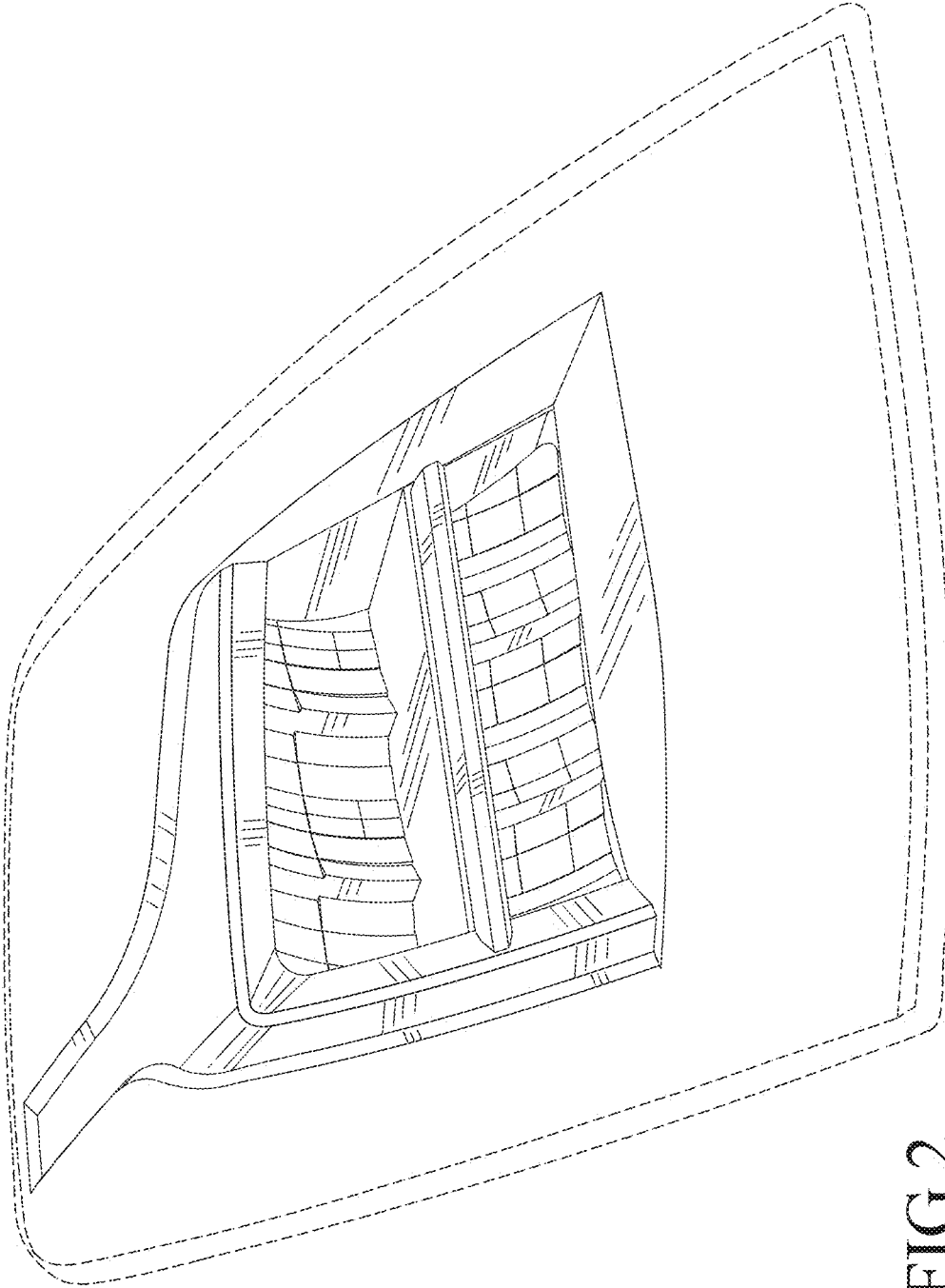

FIG.2

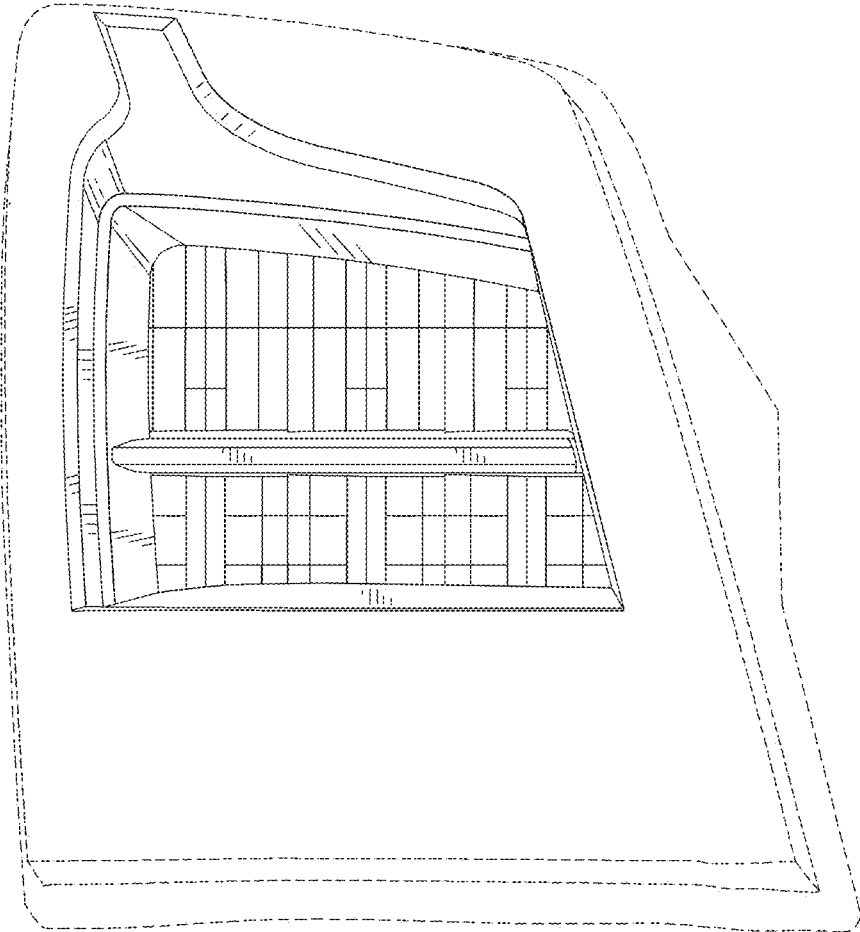

FIG.3

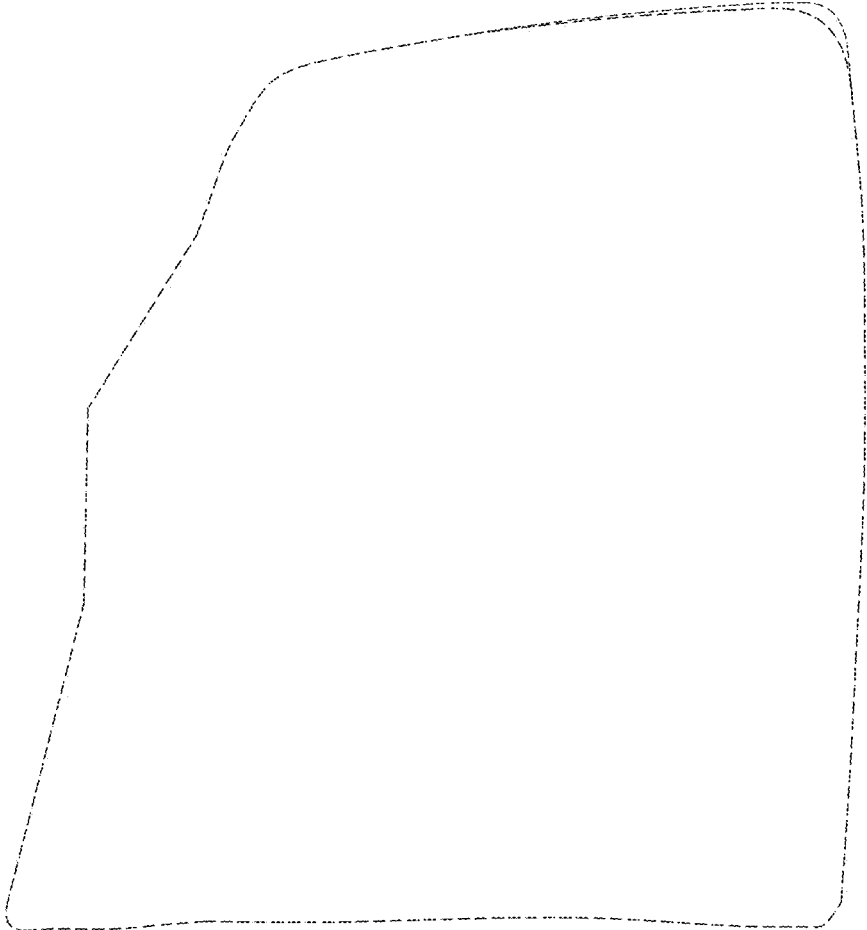

FIG.4

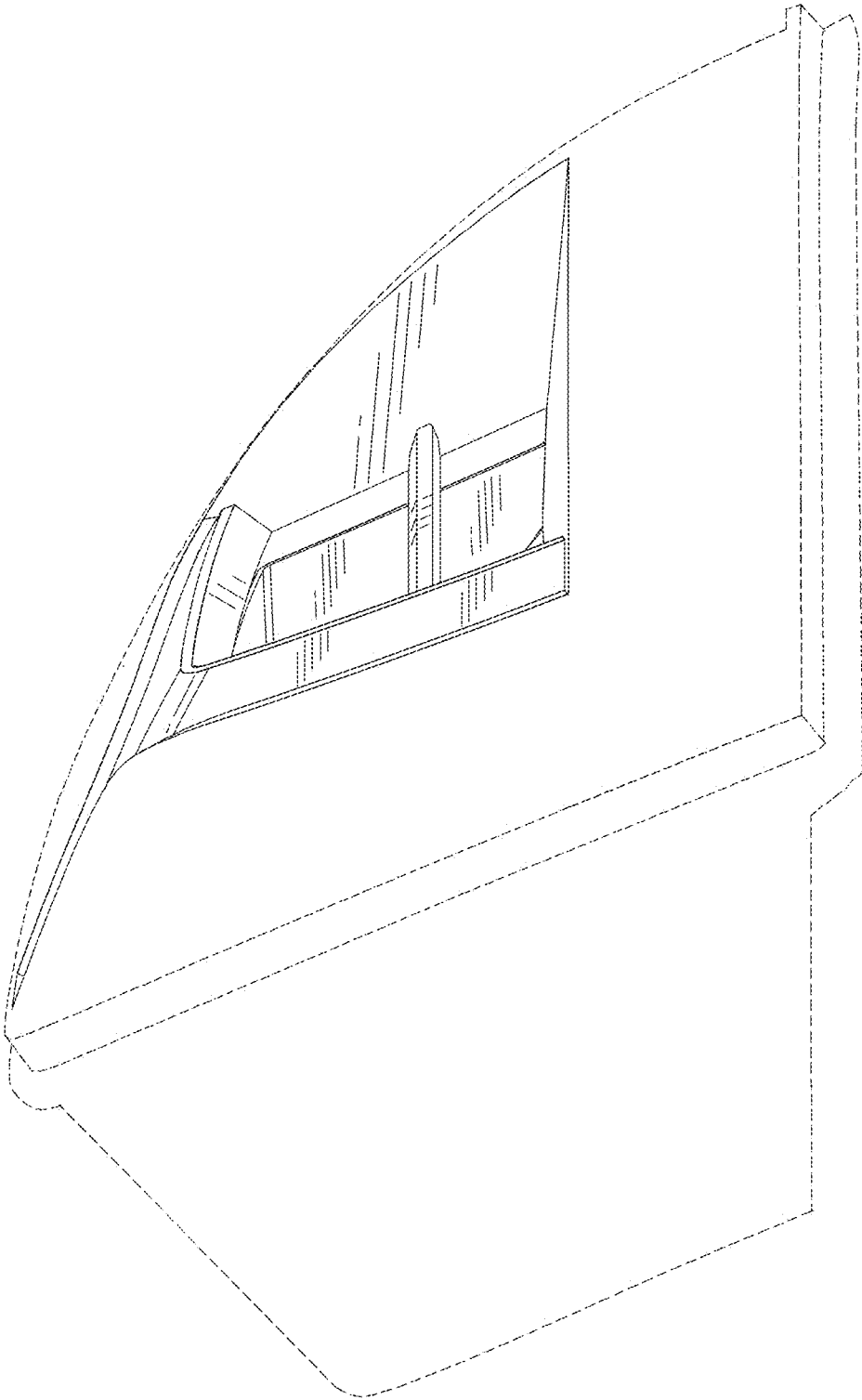

FIG. 5

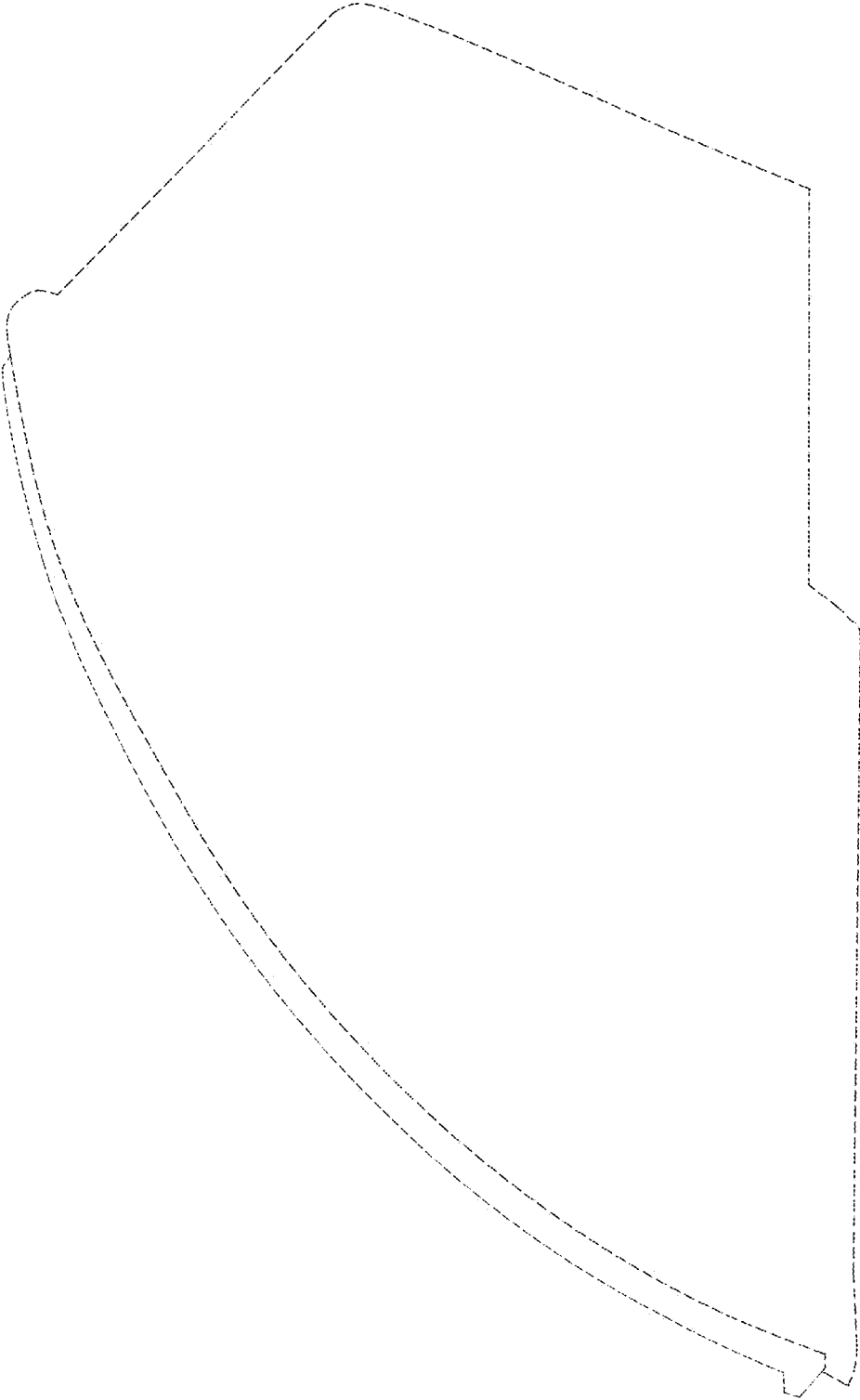

FIG.6

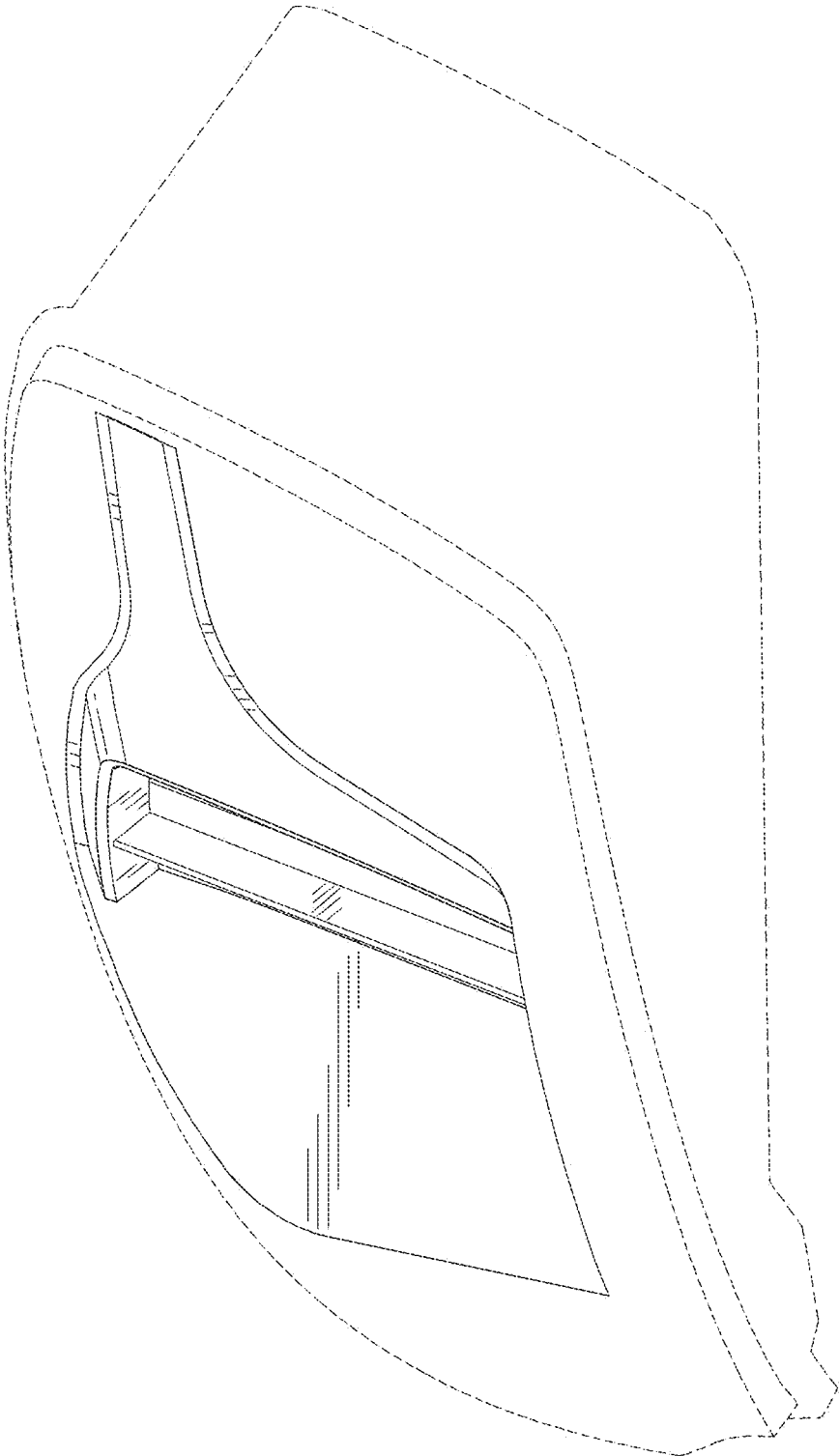

FIG.7

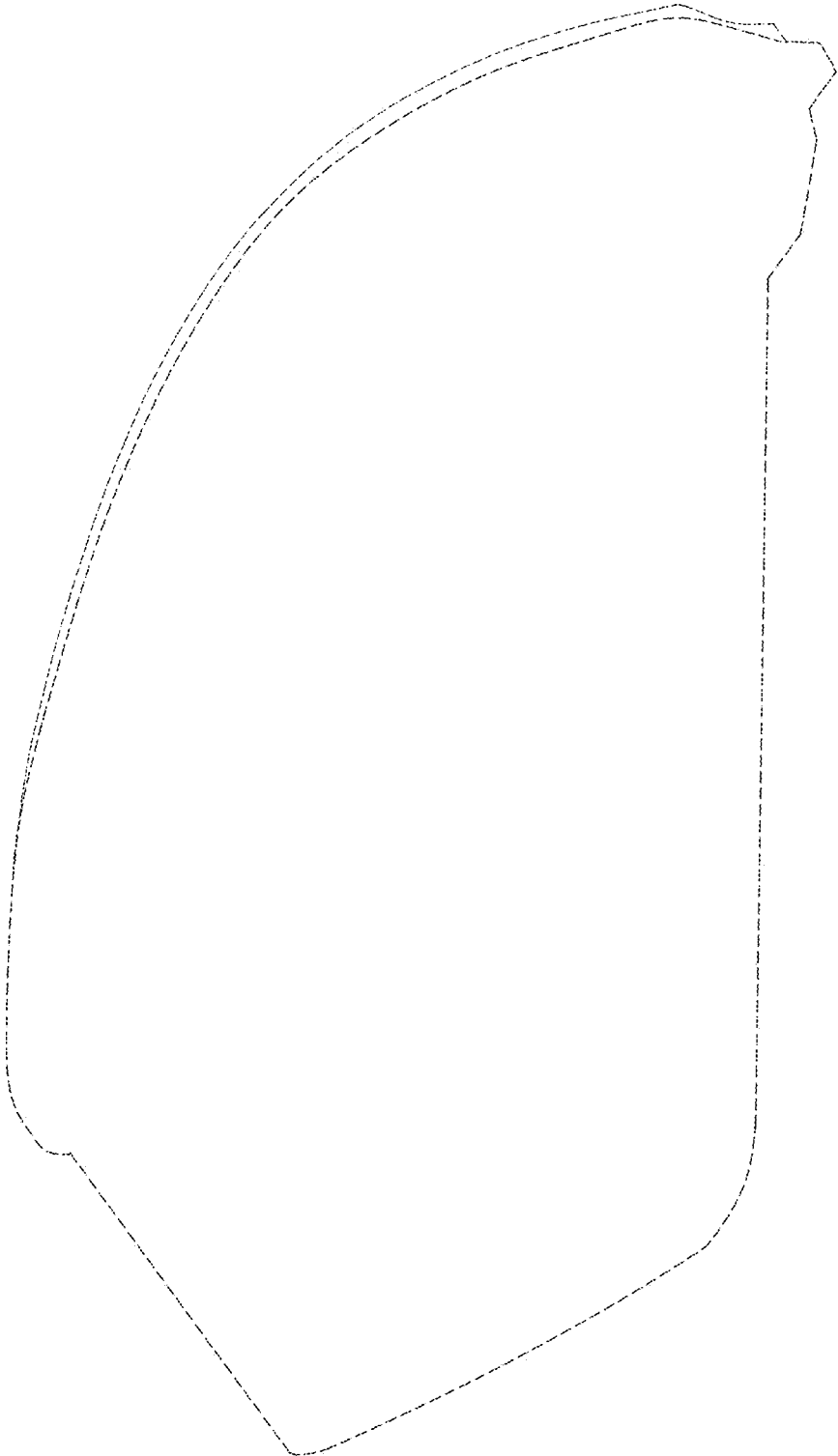

FIG.8