



US00D733449S

(12) **United States Design Patent**
Adams, IV et al.

(10) **Patent No.:** **US D733,449 S**
(45) **Date of Patent:** **** Jul. 7, 2015**

(54) **ADIRONDACK CHAIR**
(71) Applicants: **William E. Adams, IV**, Zelenople, PA (US); **Matthew Goodworth**, Pittsburgh, PA (US)
(72) Inventors: **William E. Adams, IV**, Zelenople, PA (US); **Matthew Goodworth**, Pittsburgh, PA (US)
(73) Assignee: **Adams Mfg. Corp.**, Portersville, PA (US)
(**) Term: **14 Years**
(21) Appl. No.: **29/496,796**
(22) Filed: **Jul. 17, 2014**
(51) **LOC (10) Cl.** **06-01**
(52) **U.S. Cl.**
USPC **D6/370**
(58) **Field of Classification Search**
USPC D6/334-336, 361, 370, 374, 379, 380, D6/716, 716.1, 716.2, 716.3, 716.4
CPC A47C 3/04; A47C 4/02; A47C 4/03; A47C 5/12; A47C 7/16
See application file for complete search history.

2,650,652 A 9/1953 Watson
2,843,195 A 7/1958 Barvaeus
3,845,986 A 11/1974 Rowland
4,522,446 A 6/1985 Sheridan
4,541,670 A 9/1985 Morgenstern et al.
4,635,998 A 1/1987 Hickey
4,707,023 A 11/1987 Hickey
D295,927 S 5/1988 Hickey
4,890,881 A 1/1990 Ollat et al.
4,976,492 A 12/1990 Ziegler
D319,354 S 8/1991 Wolcott
5,044,691 A 9/1991 Guichon
5,120,071 A 6/1992 Thibault et al.
D334,299 S 3/1993 Embree
5,240,214 A 8/1993 Birnbaum et al.
D360,537 S 7/1995 vanSkiver
D362,556 S 9/1995 vanSkiver
D366,771 S 2/1996 Lyons
5,511,849 A 4/1996 Cahaley et al.
D384,511 S 10/1997 Gresens
D407,227 S 3/1999 Walters
D407,228 S 3/1999 Walters
5,911,469 A 6/1999 Young
D413,452 S 9/1999 Rhienen
D413,453 S 9/1999 van Rhienen
D413,736 S 9/1999 Jackson

(Continued)

Primary Examiner — Mimosa De
(74) *Attorney, Agent, or Firm* — Buchanan Ingersoll & Rooney PC

(56) **References Cited**

U.S. PATENT DOCUMENTS

D68,027 S 8/1925 Wurdack
D78,926 S 7/1929 Gottlob
D84,585 S 7/1931 Ledder et al.
2,072,075 A 2/1937 Travers et al.
D109,239 S * 4/1938 Wolpin D6/370
2,192,672 A 3/1940 Connor, Jr.
2,195,461 A 4/1940 Koenig
2,222,296 A 11/1940 Luiken
D148,391 S 1/1948 Plourde et al.
2,490,884 A 12/1949 Rau
2,517,039 A 8/1950 Shook
2,600,626 A 6/1952 Ellingson
2,603,273 A 7/1952 Gambrell

(57) **CLAIM**

The ornamental design for an adirondack chair, as shown and described.

DESCRIPTION

FIG. 1 is a front view of our adirondack chair;
FIG. 2 is a top view thereof
FIG. 3 is a left side view thereof;
FIG. 4 is a right side view thereof;
FIG. 5 is a bottom view thereof;
FIG. 6 is a back view thereof; and,
FIG. 7 is a perspective view thereof.

1 Claim, 7 Drawing Sheets

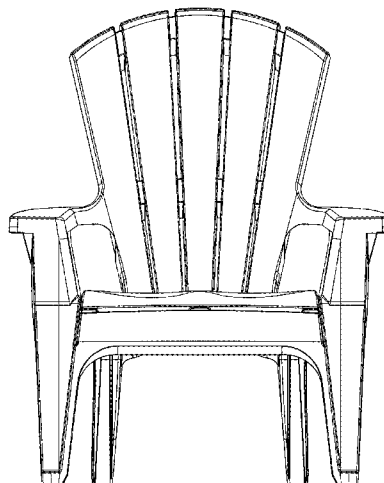

(56)

References Cited

U.S. PATENT DOCUMENTS

D416,397 S	11/1999	Niemiec	6,986,549 B2	1/2006	Kniese	
5,997,094 A	12/1999	Cvek	D538,086 S	3/2007	Shake	
6,003,946 A	12/1999	Jackson	D570,127 S	6/2008	Spink	
D418,323 S	1/2000	van Rhienen	7,401,854 B2	7/2008	Adams	
D420,824 S	2/2000	Lin	D607,223 S	1/2010	Adams et al.	
D425,719 S	5/2000	Chalmers et al.	7,748,786 B1	7/2010	Brower	
D430,748 S	9/2000	Chalmers et al.	D646,068 S	10/2011	Bogdan et al.	
D443,430 S *	6/2001	Anderson et al. D6/370	D660,040 S	5/2012	Bogdan et al.	
6,616,228 B2	9/2003	Heidmann	8,333,430 B2	12/2012	Adams et al.	
6,688,687 B2	2/2004	Chu	D677,069 S	3/2013	Adams, IV	
D503,550 S	4/2005	Miesieski et al.	D704,464 S *	5/2014	Mifsud	D6/361
D509,970 S	9/2005	Adams	D712,172 S *	9/2014	Saylor	D6/370
			D717,058 S *	11/2014	Prokofiev et al.	D6/370
			2005/0200167 A1	9/2005	Bollenbach	
			2006/0163920 A1	7/2006	Adams	

* cited by examiner

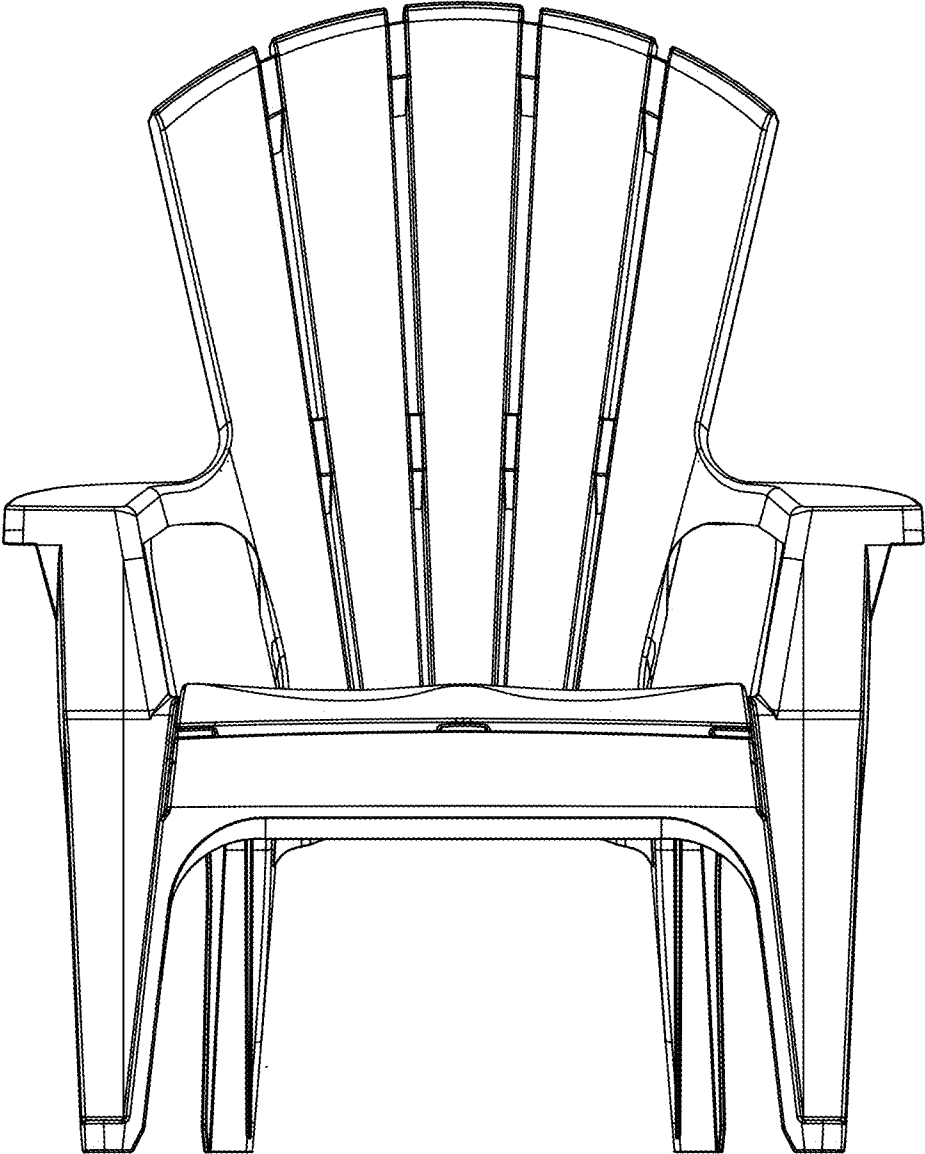

FIG. 1

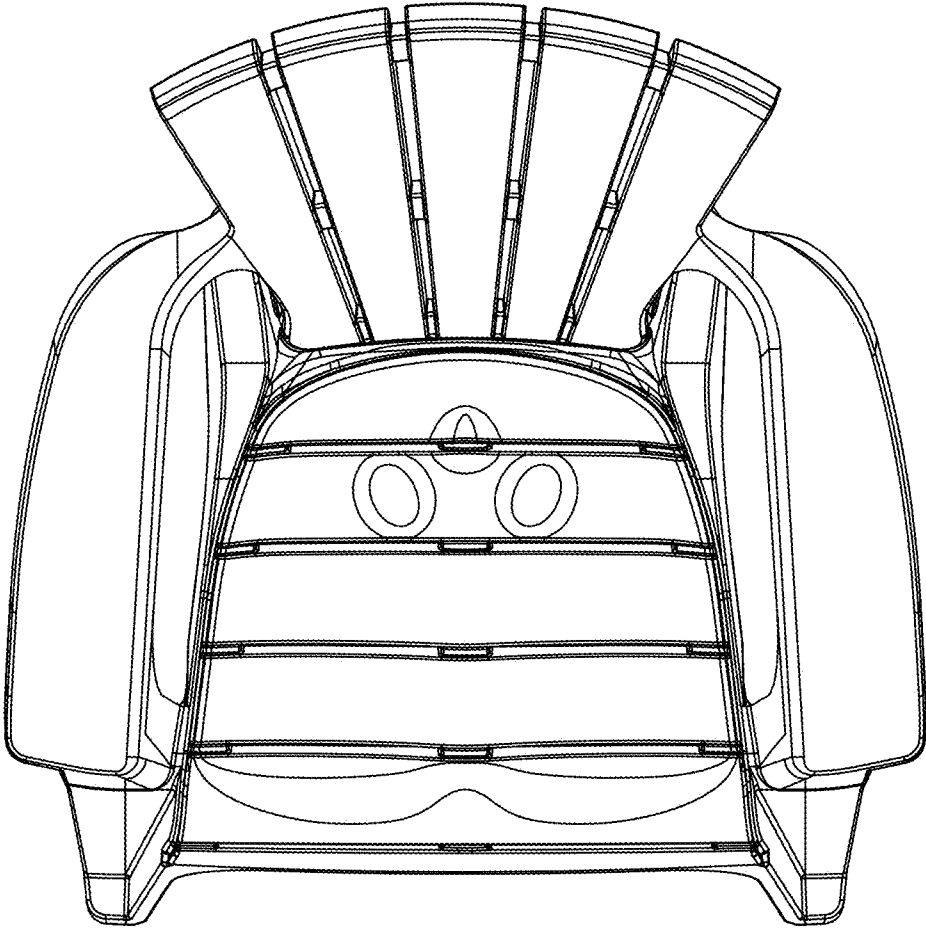

FIG. 2

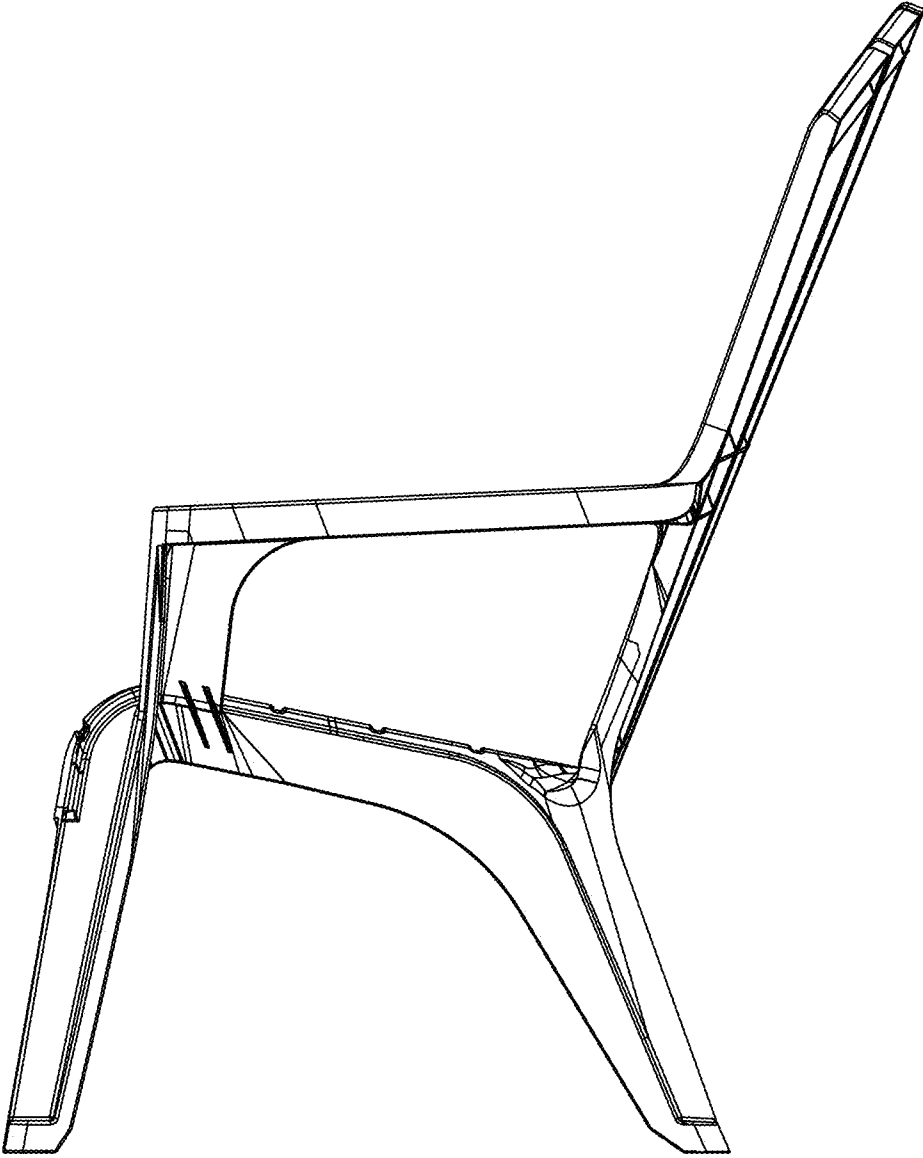

FIG. 3

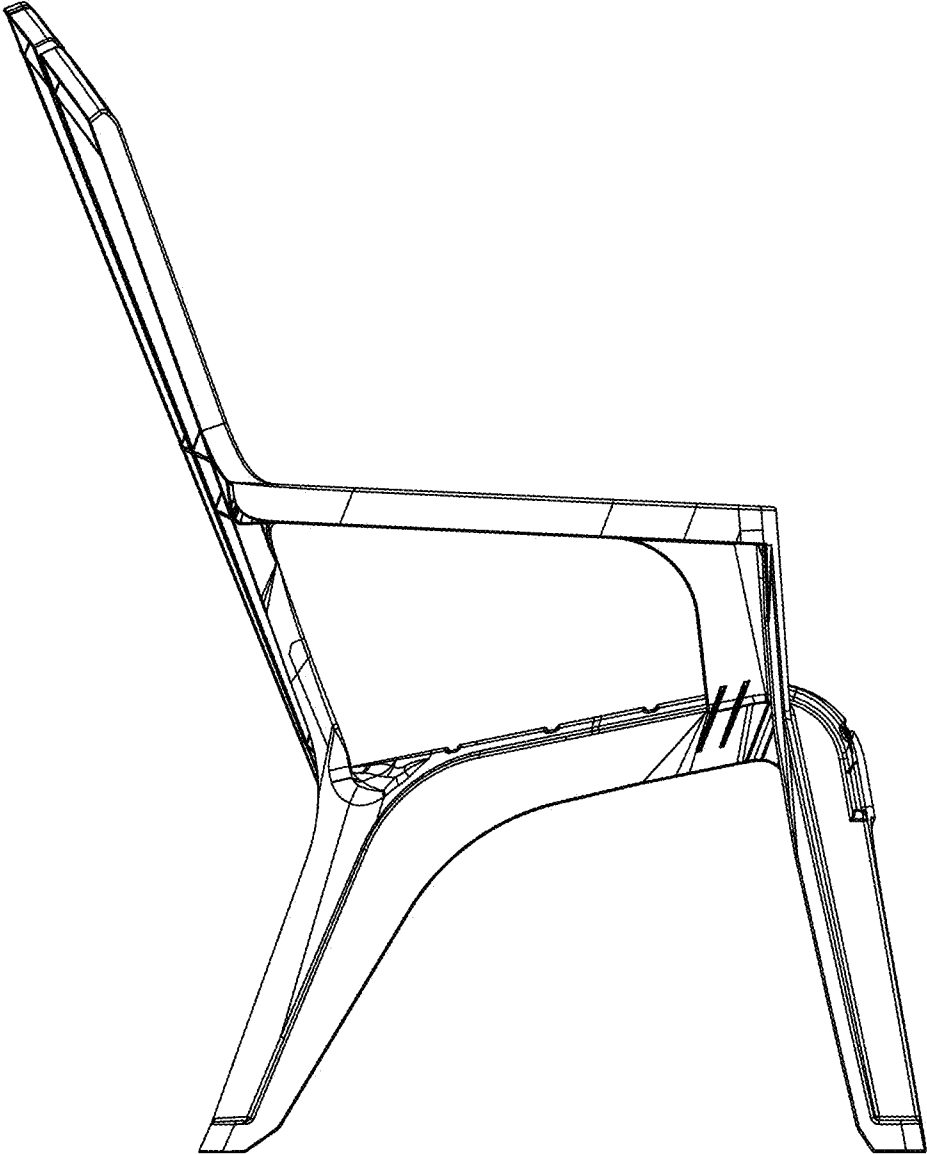

FIG. 4

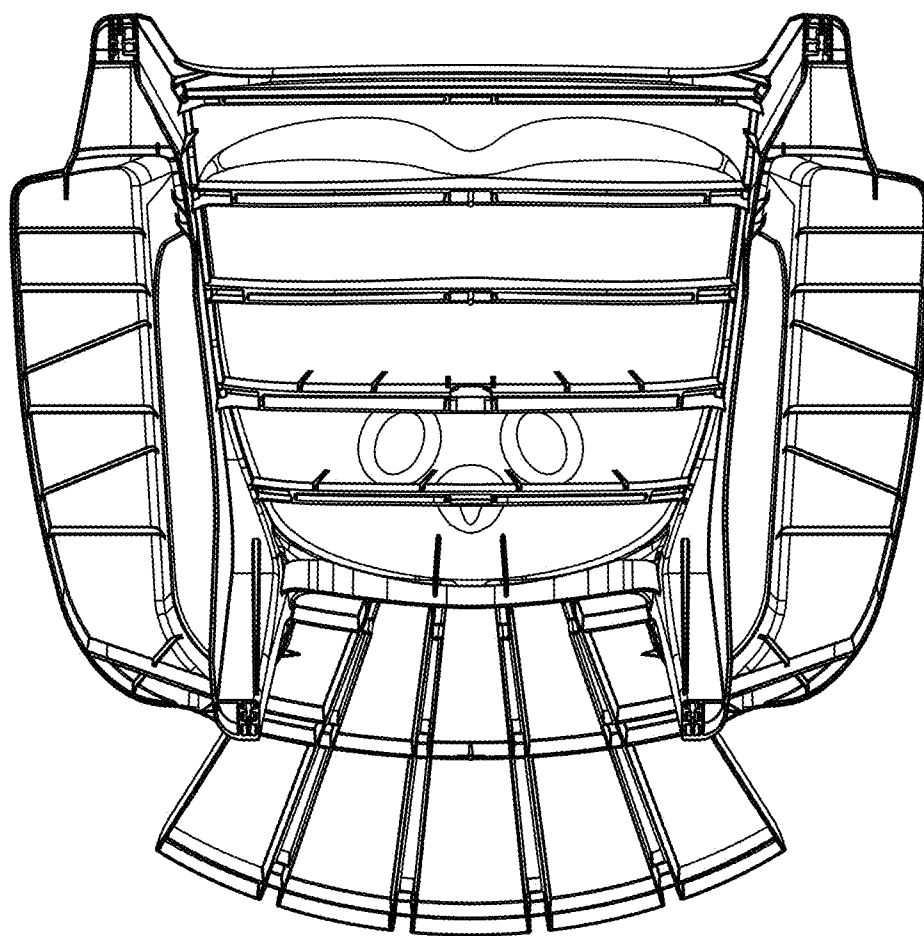

FIG. 5

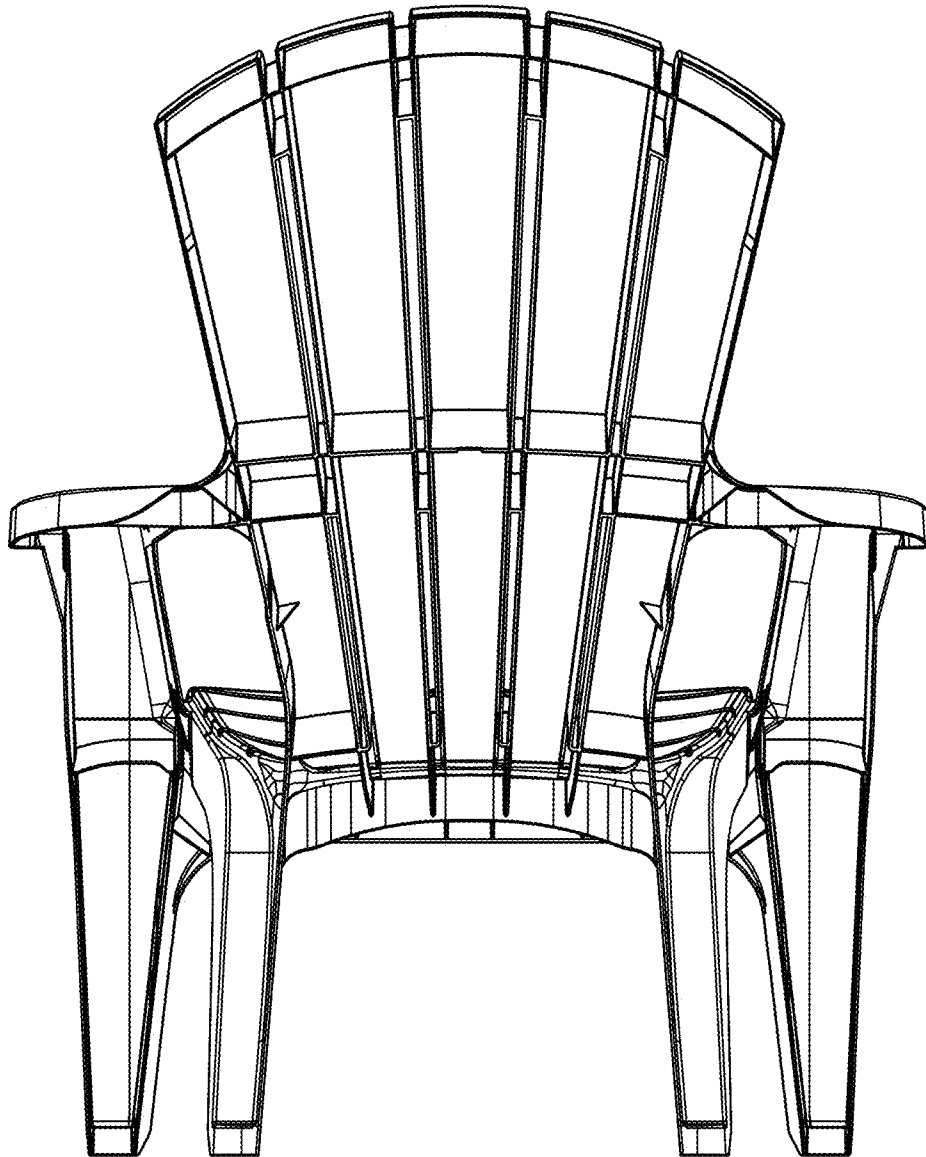

FIG. 6

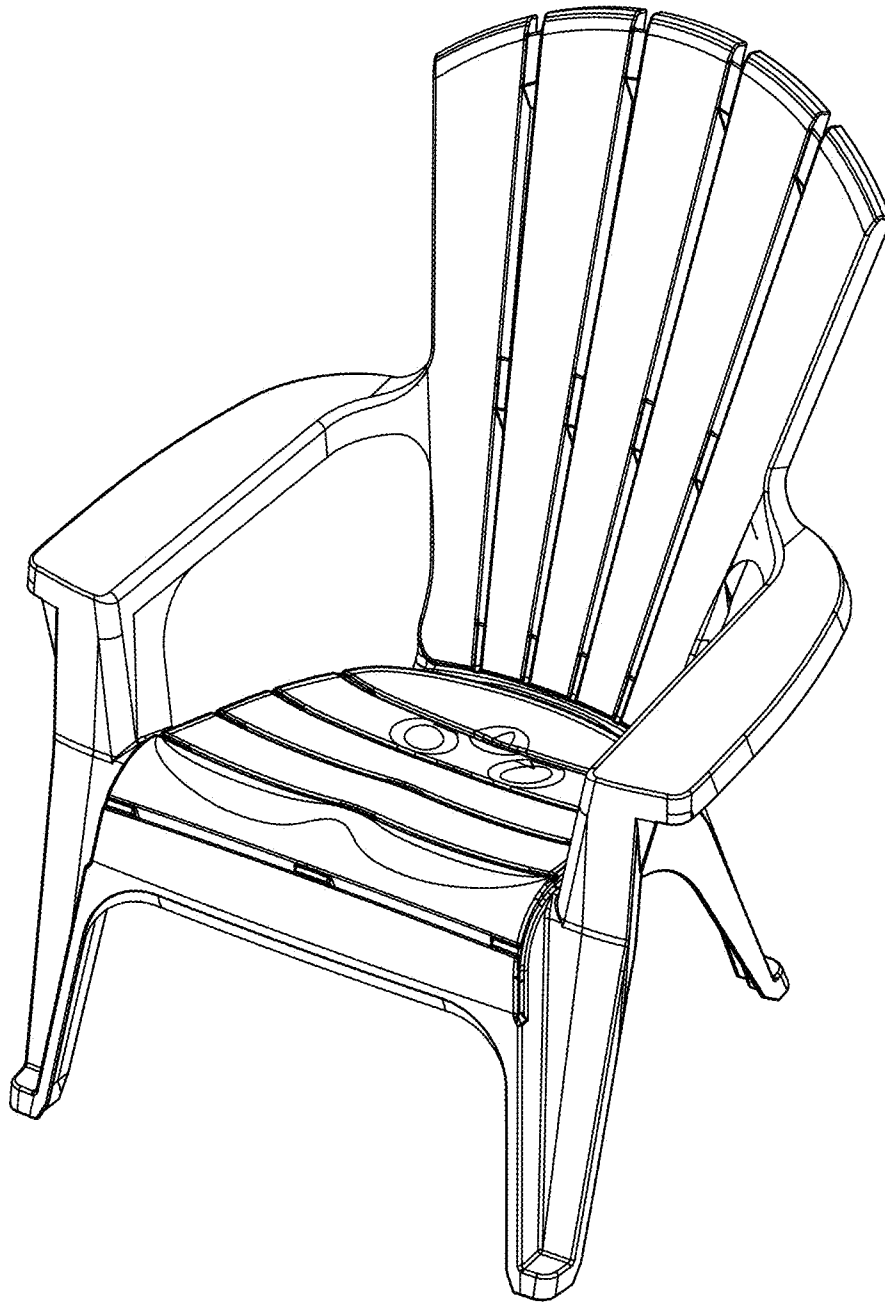

FIG. 7